

Surface mount transient voltage suppressor power 400 watts  
Stand-Off Voltage: 5.0V~440V

**FEATURES**

- ◆For surface mounted applications in order to optimize board space.
- ◆Low profile package.
- ◆Glass passivated junction.
- ◆Low inductance.
- ◆Plastic package has Underwriters Laboratory Flammability.

**MECHANICAL DATA**

- ◆Case: DO-214AC/SMA
- ◆Terminals: Solderable per MIL-STD-750, Method 2026
- ◆Approx. Weight: 0.07g /0.002oz

**Maximum Ratings and Electrical characteristics**  
Ratings at 25 ambient temperature unless o °C therwise specified.

| Parameter                                                    | Symbol                                 | Value                   | Unit        |
|--------------------------------------------------------------|----------------------------------------|-------------------------|-------------|
| Peak Pulse Power Dissipation on TA=25°C (Note 1,2,5, Fig1)   | <b>P<sub>PPM</sub></b>                 | 400                     | <b>W</b>    |
| Peak Forward Surge Current (Note3, Note4)                    | <b>I<sub>FSM</sub></b><br><b>(UNI)</b> | 40                      | <b>A</b>    |
| Peak Pulse Current on 10/1000 us waveform (Note 1) Fig 3     | <b>I<sub>PPM</sub></b>                 | see Table 1             | <b>A</b>    |
| ESD Voltage per IEC6100-4-2                                  | Contact                                | <b>V<sub>ESD1</sub></b> | <b>kV</b>   |
|                                                              | Air                                    | <b>V<sub>ESD2</sub></b> |             |
| Typical Junction Capacitance at VR=4V, f=1MHz                | <b>C<sub>j</sub></b>                   | 390                     | <b>pF</b>   |
| Typical Thermal Resistance Junction to Ambient(Note 2)       | <b>R<sub>θJA</sub></b>                 | 70                      | <b>°C/W</b> |
| Operating Junction Temperature and Storage Temperature Range | <b>T<sub>J</sub>, T<sub>STG</sub></b>  | -55 to +150             | <b>°C</b>   |

**NOTES:**

1. Non-repetitive current pulse, per Fig.3 and derated above T<sub>A</sub> = 25°C per Fig. 2.
2. Mounted on 5mm<sup>2</sup> copper pads to each terminal.
3. Peak Forward Surge Current : 8.3ms single half sine-wave Superimposed on rated load (JEDEC method).
4. Peak pulse power waveform is 10/1000μS.

**Pinning**

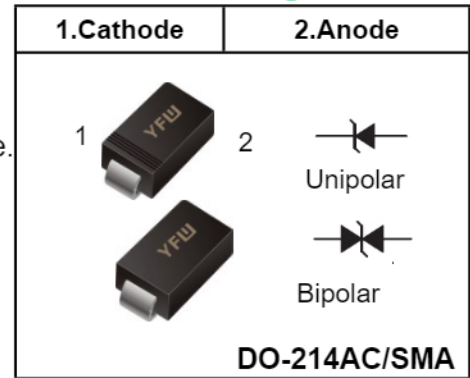

Characteristics at Ta = 25°C

Table 1

| Part Number (Uni) | Part Number (Bi) | Marking |    | Reverse Stand off Voltage $V_R$ (Volts) | Breakdown Voltage $V_{BR}$ (Volts) @ $I_T$ |        | Test Current $I_T$ (mA) | Maximum Clamping Voltage $V_C$ @ $I_{PP}$ (V) | Maximum Peak Pulse Current $I_{PP}$ (A) | Maximum Reverse Leakage $I_R$ @ $V_R$ ( $\mu A$ ) | Agency Approval  |
|-------------------|------------------|---------|----|-----------------------------------------|--------------------------------------------|--------|-------------------------|-----------------------------------------------|-----------------------------------------|---------------------------------------------------|-----------------------------------------------------------------------------------------------------|
|                   |                  | UNI     | BI |                                         | MIN                                        | MAX    |                         |                                               |                                         |                                                   |                                                                                                     |
| SMAJ5.0A          | SMAJ5.0CA        | AE      | WE | 5.0                                     | 6.40                                       | 07.00  | 10                      | 9.2                                           | 43.5                                    | 800                                               | X                                                                                                   |
| SMAJ6.0A          | SMAJ6.0CA        | AG      | WG | 6.0                                     | 6.67                                       | 07.37  | 10                      | 10.3                                          | 38.8                                    | 800                                               | X                                                                                                   |
| SMAJ6.5A          | SMAJ6.5CA        | AK      | WK | 6.5                                     | 7.22                                       | 7.98   | 10                      | 11.2                                          | 35.7                                    | 500                                               | X                                                                                                   |
| SMAJ7.0A          | SMAJ7.0CA        | AM      | WM | 7.0                                     | 7.78                                       | 8.60   | 10                      | 12.0                                          | 33.3                                    | 200                                               | X                                                                                                   |
| SMAJ7.5A          | SMAJ7.5CA        | AP      | WP | 7.5                                     | 8.33                                       | 9.21   | 1                       | 12.9                                          | 31.0                                    | 100                                               | X                                                                                                   |
| SMAJ8.0A          | SMAJ8.0CA        | AR      | WR | 8.0                                     | 8.89                                       | 9.83   | 1                       | 13.6                                          | 29.4                                    | 50                                                | X                                                                                                   |
| SMAJ8.5A          | SMAJ8.5CA        | AT      | WT | 8.5                                     | 9.44                                       | 10.40  | 1                       | 14.4                                          | 27.8                                    | 20                                                | X                                                                                                   |
| SMAJ9.0A          | SMAJ9.0CA        | AV      | VV | 9.0                                     | 10.00                                      | 11.10  | 1                       | 15.4                                          | 26.0                                    | 10                                                | X                                                                                                   |
| SMAJ10A           | SMAJ10CA         | AX      | WX | 10.0                                    | 11.10                                      | 12.30  | 1                       | 17.0                                          | 23.5                                    | 5                                                 | X                                                                                                   |
| SMAJ11A           | SMAJ11CA         | AZ      | WZ | 11.0                                    | 12.20                                      | 13.50  | 1                       | 18.2                                          | 22.0                                    | 1                                                 | X                                                                                                   |
| SMAJ12A           | SMAJ12CA         | BE      | XE | 12.0                                    | 13.30                                      | 14.70  | 1                       | 19.9                                          | 20.1                                    | 1                                                 | X                                                                                                   |
| SMAJ13A           | SMAJ13CA         | BG      | XG | 13.0                                    | 14.40                                      | 15.90  | 1                       | 21.5                                          | 18.6                                    | 1                                                 | X                                                                                                   |
| SMAJ14A           | SMAJ14CA         | BK      | XK | 14.0                                    | 15.60                                      | 17.20  | 1                       | 23.2                                          | 17.2                                    | 1                                                 | X                                                                                                   |
| SMAJ15A           | SMAJ15CA         | BM      | XM | 15.0                                    | 16.70                                      | 18.50  | 1                       | 24.4                                          | 16.4                                    | 1                                                 | X                                                                                                   |
| SMAJ16A           | SMAJ16CA         | BP      | XP | 16.0                                    | 17.80                                      | 19.70  | 1                       | 26.0                                          | 15.4                                    | 1                                                 | X                                                                                                   |
| SMAJ17A           | SMAJ17CA         | BR      | XR | 17.0                                    | 18.90                                      | 20.90  | 1                       | 27.6                                          | 14.5                                    | 1                                                 | X                                                                                                   |
| SMAJ18A           | SMAJ18CA         | BT      | XT | 18.0                                    | 20.00                                      | 22.10  | 1                       | 29.2                                          | 13.7                                    | 1                                                 | X                                                                                                   |
| SMAJ20A           | SMAJ20CA         | BV      | XV | 20.0                                    | 22.20                                      | 24.50  | 1                       | 32.4                                          | 12.3                                    | 1                                                 | X                                                                                                   |
| SMAJ22A           | SMAJ22CA         | BX      | XX | 22.0                                    | 24.40                                      | 26.90  | 1                       | 35.5                                          | 11.3                                    | 1                                                 | X                                                                                                   |
| SMAJ24A           | SMAJ24CA         | BZ      | XZ | 24.0                                    | 26.70                                      | 29.50  | 1                       | 38.9                                          | 10.3                                    | 1                                                 | X                                                                                                   |
| SMAJ26A           | SMAJ26CA         | CE      | YE | 26.0                                    | 28.90                                      | 31.90  | 1                       | 42.1                                          | 9.5                                     | 1                                                 | X                                                                                                   |
| SMAJ28A           | SMAJ28CA         | CG      | YG | 28.0                                    | 31.10                                      | 34.40  | 1                       | 45.4                                          | 8.8                                     | 1                                                 | X                                                                                                   |
| SMAJ30A           | SMAJ30CA         | CK      | YK | 30.0                                    | 33.30                                      | 36.80  | 1                       | 48.4                                          | 8.3                                     | 1                                                 | X                                                                                                   |
| SMAJ33A           | SMAJ33CA         | CM      | YM | 33.0                                    | 36.70                                      | 40.60  | 1                       | 53.3                                          | 7.5                                     | 1                                                 | X                                                                                                   |
| SMAJ36A           | SMAJ36CA         | CP      | YP | 36.0                                    | 40.00                                      | 44.20  | 1                       | 58.1                                          | 6.9                                     | 1                                                 | X                                                                                                   |
| SMAJ40A           | SMAJ40CA         | CR      | YR | 40.0                                    | 44.40                                      | 49.10  | 1                       | 64.5                                          | 6.2                                     | 1                                                 | X                                                                                                   |
| SMAJ43A           | SMAJ43CA         | CT      | YT | 43.0                                    | 47.80                                      | 52.80  | 1                       | 69.4                                          | 5.8                                     | 1                                                 | X                                                                                                   |
| SMAJ45A           | SMAJ45CA         | CV      | YV | 45.0                                    | 50.00                                      | 55.30  | 1                       | 72.7                                          | 5.5                                     | 1                                                 | X                                                                                                   |
| SMAJ48A           | SMAJ48CA         | CX      | YX | 48.0                                    | 53.30                                      | 58.90  | 1                       | 77.4                                          | 5.2                                     | 1                                                 | X                                                                                                   |
| SMAJ51A           | SMAJ51CA         | CZ      | YZ | 51.0                                    | 56.70                                      | 62.70  | 1                       | 82.4                                          | 4.9                                     | 1                                                 | X                                                                                                   |
| SMAJ54A           | SMAJ54CA         | RE      | ZE | 54.0                                    | 60.00                                      | 66.30  | 1                       | 87.1                                          | 4.6                                     | 1                                                 | X                                                                                                   |
| SMAJ58A           | SMAJ58CA         | RG      | ZG | 58.0                                    | 64.40                                      | 71.20  | 1                       | 93.6                                          | 4.3                                     | 1                                                 | X                                                                                                   |
| SMAJ60A           | SMAJ60CA         | RK      | ZK | 60.0                                    | 66.70                                      | 73.70  | 1                       | 96.8                                          | 4.1                                     | 1                                                 | X                                                                                                   |
| SMAJ64A           | SMAJ64CA         | RM      | ZM | 64.0                                    | 71.10                                      | 78.60  | 1                       | 103.0                                         | 3.9                                     | 1                                                 | X                                                                                                   |
| SMAJ70A           | SMAJ70CA         | RP      | ZP | 70.0                                    | 77.80                                      | 86.00  | 1                       | 113.0                                         | 3.5                                     | 1                                                 | X                                                                                                   |
| SMAJ75A           | SMAJ75CA         | RR      | ZR | 75.0                                    | 83.30                                      | 92.10  | 1                       | 121.0                                         | 3.3                                     | 1                                                 | X                                                                                                   |
| SMAJ78A           | SMAJ78CA         | RT      | ZT | 78.0                                    | 86.70                                      | 95.80  | 1                       | 126.0                                         | 3.2                                     | 1                                                 | X                                                                                                   |
| SMAJ85A           | SMAJ85CA         | RV      | ZV | 85.0                                    | 94.40                                      | 104.00 | 1                       | 137.0                                         | 2.9                                     | 1                                                 | X                                                                                                   |
| SMAJ90A           | SMAJ90CA         | RX      | ZX | 90.0                                    | 100.00                                     | 111.00 | 1                       | 146.0                                         | 2.7                                     | 1                                                 | X                                                                                                   |
| SMAJ100A          | SMAJ100CA        | RZ      | ZZ | 100.0                                   | 111.00                                     | 123.00 | 1                       | 162.0                                         | 2.5                                     | 1                                                 | X                                                                                                   |
| SMAJ110A          | SMAJ110CA        | SE      | VE | 110.0                                   | 122.00                                     | 135.00 | 1                       | 177.0                                         | 2.3                                     | 1                                                 | X                                                                                                   |
| SMAJ120A          | SMAJ120CA        | SG      | VG | 120.0                                   | 133.00                                     | 147.00 | 1                       | 193.0                                         | 2.1                                     | 1                                                 | X                                                                                                   |
| SMAJ130A          | SMAJ130CA        | SK      | VK | 130.0                                   | 144.00                                     | 159.00 | 1                       | 209.0                                         | 1.9                                     | 1                                                 | X                                                                                                   |
| SMAJ150A          | SMAJ150CA        | SM      | VM | 150.0                                   | 167.00                                     | 185.00 | 1                       | 243.0                                         | 1.6                                     | 1                                                 | X                                                                                                   |
| SMAJ160A          | SMAJ160CA        | SP      | VP | 160.0                                   | 178.00                                     | 197.00 | 1                       | 259.0                                         | 1.5                                     | 1                                                 | X                                                                                                   |
| SMAJ170A          | SMAJ170CA        | SR      | VR | 170.0                                   | 189.00                                     | 209.00 | 1                       | 275.0                                         | 1.5                                     | 1                                                 | X                                                                                                   |
| SMAJ180A          | SMAJ180CA        | ST      | VT | 180.0                                   | 201.00                                     | 222.00 | 1                       | 292.0                                         | 1.4                                     | 1                                                 | X                                                                                                   |
| SMAJ200A          | SMAJ200CA        | SV      | VV | 200.0                                   | 224.00                                     | 247.00 | 1                       | 324.0                                         | 1.2                                     | 1                                                 | X                                                                                                   |
| SMAJ220A          | SMAJ220CA        | SX      | VX | 220.0                                   | 246.00                                     | 272.00 | 1                       | 356.0                                         | 1.1                                     | 1                                                 | X                                                                                                   |
| SMAJ250A          | SMAJ250CA        | SZ      | VZ | 250.0                                   | 279.00                                     | 309.00 | 1                       | 405.0                                         | 1.0                                     | 1                                                 | X                                                                                                   |
| SMAJ300A          | SMAJ300CA        | TE      | UE | 300.0                                   | 335.00                                     | 371.00 | 1                       | 486.0                                         | 0.8                                     | 1                                                 | X                                                                                                   |
| SMAJ350A          | SMAJ350CA        | TG      | UG | 350.0                                   | 391.00                                     | 432.00 | 1                       | 567.0                                         | 0.7                                     | 1                                                 | X                                                                                                   |
| SMAJ400A          | SMAJ400CA        | TK      | UK | 400.0                                   | 447.00                                     | 494.00 | 1                       | 648.0                                         | 0.6                                     | 1                                                 | X                                                                                                   |
| SMAJ440A          | SMAJ440CA        | TM      | UM | 440.0                                   | 492.00                                     | 543.00 | 1                       | 713.0                                         | 0.6                                     | 1                                                 | X                                                                                                   |

For bidirectional type having  $V_{RWM}$  of 10 volts and less, the  $I_R$  limit is double.  
 For parts without A ( $V_{BR}$  is  $\pm 10\%$  and  $V_C$  is 5% higher than with A parts).

Fig.1 Peak Pulse Power Rating Curve

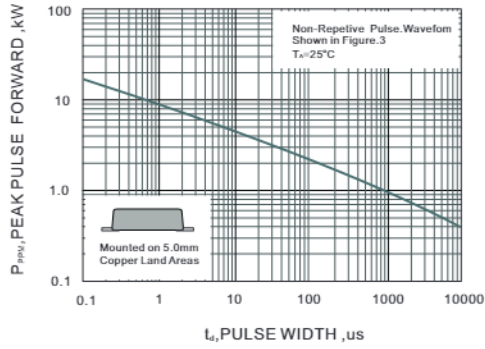

Fig.2 Forward Current Derating Curve

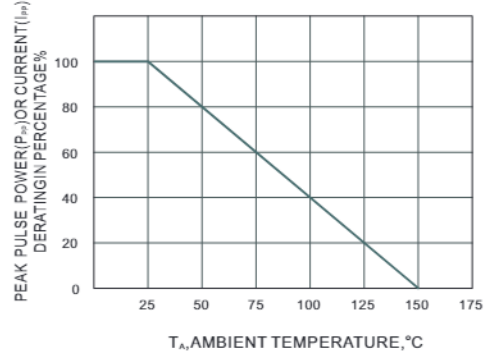

Fig.3 Pulse Waveform

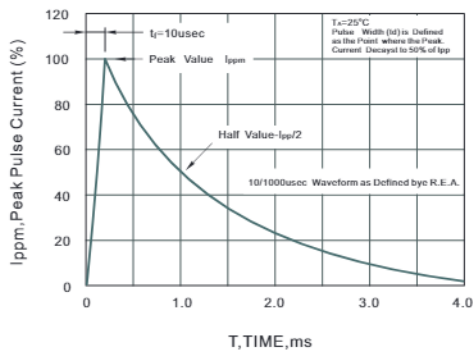
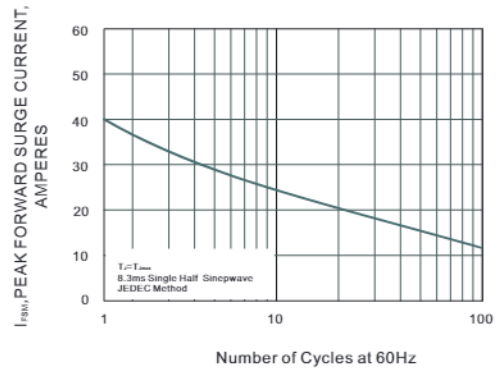

Fig.4 Maximum Non-Repetitive Peak Forward Surge Current



**Package Outline**

**DO-214AC SMA**

Plastic surface mounted package; 2 leads

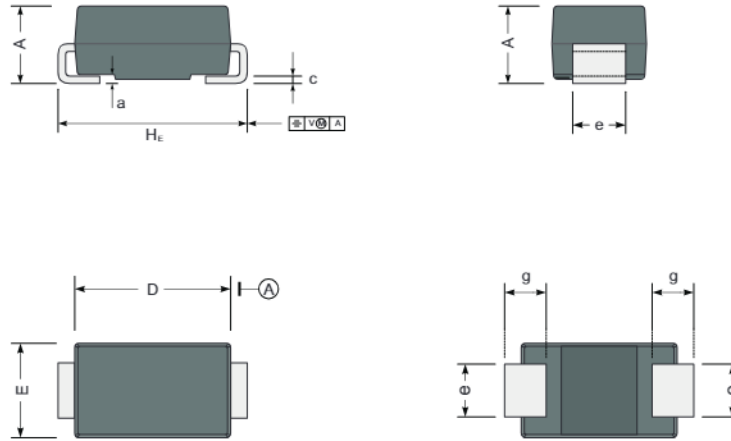

| UNIT |     | A    | D   | E    | H <sub>E</sub> | c    | e   | g   | a   |
|------|-----|------|-----|------|----------------|------|-----|-----|-----|
| mm   | max | 2.42 | 4.5 | 2.80 | 5.2            | 0.31 | 1.6 | 1.5 | 0.3 |
|      | min | 1.98 | 4.0 | 2.54 | 4.7            | 0.15 | 1.3 | 0.9 |     |
| mil  | max | 96   | 181 | 110  | 205            | 12   | 63  | 59  | 12  |
|      | min | 78   | 157 | 100  | 185            | 6    | 51  | 35  |     |

**The recommended mounting pad size**

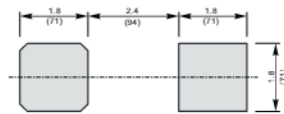

Unit :  $\frac{\text{mm}}{\text{(mil)}}$

**Summary of Packing Options**

| Package      | Packing Description | Packing Quantity | Industry Standard |
|--------------|---------------------|------------------|-------------------|
| DO-214AC SMA | Tape/Reel, 11" reel | 5000             | EIA-481-1         |
|              | Tape/Reel, 7" reel  | 2000             | EIA-481-1         |

## X-ON Electronics

Largest Supplier of Electrical and Electronic Components

*Click to view similar products for [ESD Suppressors / TVS Diodes](#) category:*

*Click to view products by [YFW Electronics](#) manufacturer:*

Other Similar products are found below :

[60KS200C](#) [D18V0L1B2LP-7B](#) [D5V0F4U5P5-7](#) [NTE4902](#) [P4KE27CA](#) [P6KE11CA](#) [P6KE8.2A](#) [SA60CA](#) [SA64CA](#) [SMBJ12CATR](#)  
[SMBJ33CATR](#) [SMBJ6.5A](#) [SMBJ8.0A](#) [ESD101-B1-02ELS](#) [E6327](#) [ESD112-B1-02EL](#) [E6327](#) [ESD7451N2T5G](#) [19180-510](#) [CPDT-5V0USP-](#)  
[HF](#) [3.0SMCJ33CA-F](#) [3.0SMCJ36A-F](#) [HSPC16701B02TP](#) [JANTX1N6126A](#) [D3V3Q1B2DLP3-7](#) [D55V0M1B2WS-7](#) [SCM1293A-04SO](#)  
[ESD200-B1-CSP0201](#) [E6327](#) [SM12-7](#) [CEN955](#) [W/DATA](#) [VESD12A1A-HD1-GS08](#) [CPDQC5V0-HF](#) [D1213A-01LP4-7B](#) [ESD101-B1-02EL](#)  
[E6327](#) [AOZ8808DI-03](#) [5KP15A](#) [5KP48A](#) [5KP90A](#) [ESD3V3D7-TP](#) [15KPA36A-LF](#) [P4KE56CA](#) [P4KE68A](#) [P4KE91CATR](#) [P6KE120A](#)  
[P6KE13CA](#) [P6KE43CA](#) [P6KE6.8CA](#) [P6KE8.2](#) [P6SMBJ20CA](#) [JANTX1N6072A](#) [SR2835ESKG](#) [SA90CA](#)