

**ULTRA LOW VF SCHOTTKY RECTIFIER**
**Reverse Voltage - 150 V**
**Forward Current - 40 A**
**FEATURES**

- ◆Ultra low forward voltage
- ◆High current capability
- ◆High forward surge capability
- ◆Low power losses, High efficiency
- ◆Guarding for over voltage protection

**APPLICATIONS**

Low VF Schottky barrier rectifier are designed for high frequency, miniature switched mode power supplies such as adapters ,lighting and on-board DC/DC conerters

**MECHANICAL DATA**

- ◆Case: Molded plastic
- ◆Polarity: As marked
- ◆Mounting Position: Any
- ◆Molded Plastic: UL Flammability Classification Rating 94V-0
- ◆Lead free in compliance with EU RoHS 2011/65/EU directive
- ◆Solder bath temperature 275°C maximum,10s per JESD 22-B106

**Primary Characteristic**

<b>I<sub>o</sub></b>	<b>40A</b>
<b>V<sub>RRM</sub></b>	<b>150V</b>
<b>I<sub>FSM</sub></b>	<b>300A</b>
<b>V<sub>F</sub></b>	<b>0.70V</b>
<b>T<sub>J</sub> Max</b>	<b>150°C</b>

**Maximum Ratings at Ta=25°C unless otherwise specified**

Characteristics	Symbol	Value	Unit
Maximum Repetitive Peak Reverse Voltage	V <sub>RRM</sub>	150	V
Working Peak Reverse Voltage	V <sub>RWM</sub>	105	V
Maximum DC Blocking Voltage	V <sub>DC</sub>	150	V
Maximum Average Forward Rectified Current	Per Leg	20	A
	Total	40	
Peak Forward Surge Current,8.3 ms Single Half Sine-wave Superimposed on Rated Load (JEDEC method)	I <sub>FSM</sub>	300	A
Operating Temperature Range	T <sub>J</sub>	-50 to +150	°C
Storage Temperature Range	T <sub>STG</sub>	-50 to +150	°C
Typical Thermal Resistance (Note1) TO-220AB,TO-263/TO-220F	R <sub>θJC</sub>	2/4	°C/W

Note1: Thermal resistance from Junction to case per leg mounted on heatsink.

**Electrical Characteristics unless otherwise specified**

Characteristics	Symbol	Value		Unit	
Forward Voltage Drop(Note2)	V <sub>F</sub>	Typ.	Max.	V	
		at I <sub>F</sub> =5A	0.57		-
		0.5	-		
at I <sub>F</sub> =10A		0.73	-		
		0.6	-		
at I <sub>F</sub> =20A		0.90	1.00		
		0.7	-		
Maximum Reverse Current at V <sub>R</sub> =150V	I <sub>R</sub>	5	20		μA
		5	-		mA

Note2:Pulse test: 300 μs pulse width, 1 % duty cycle

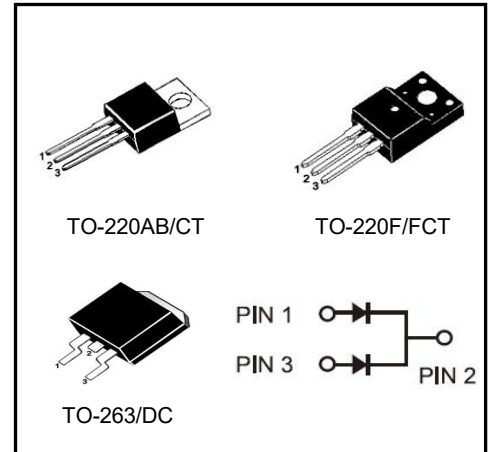

**RATINGS AND CHARACTERISTIC CURVES**

FIG. 1 MAXIMUM FORWARD CURRENT DERATING CURVE

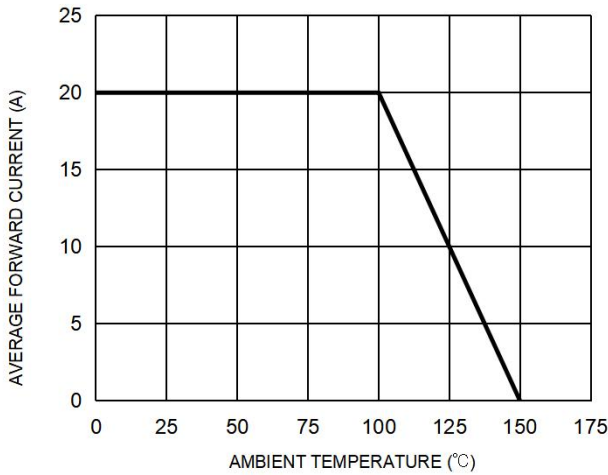

FIG. 2 MAXIMUM NON-REPETITIVE FORWARD SURGE CURRENT PER LEG

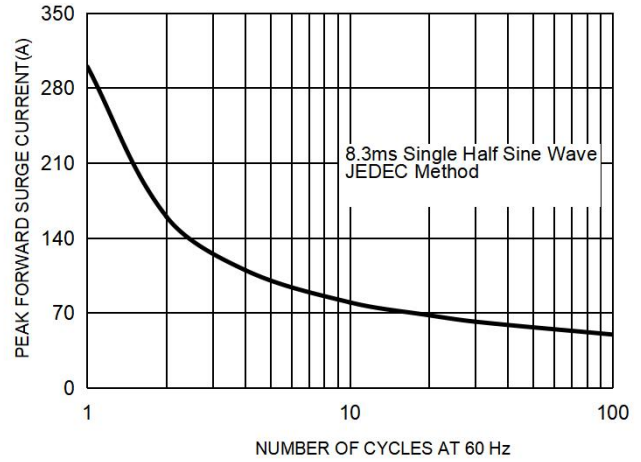

FIG. 3 TYPICAL FORWARD CHARACTERISTICS PER LEG

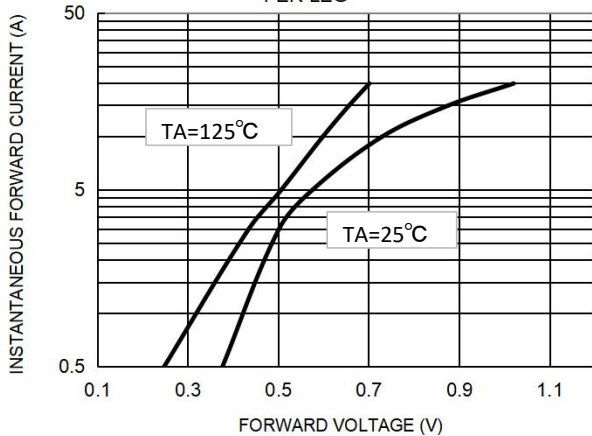
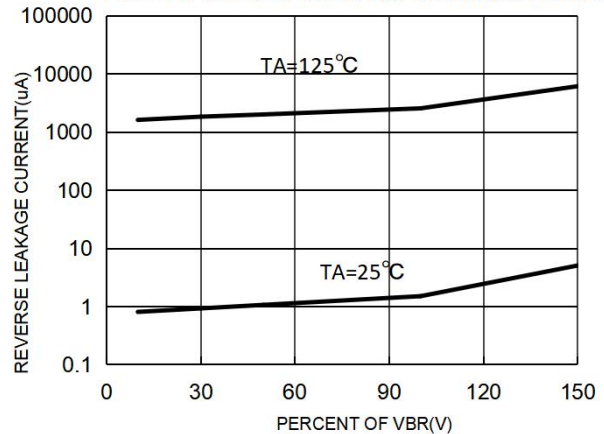
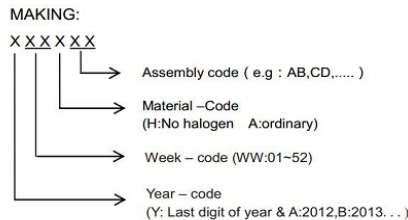
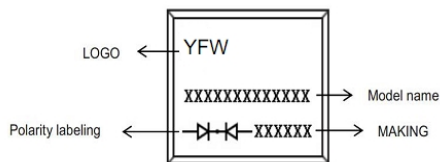

FIG. 4 TYPICAL REVERSE CHARACTERISTICS PER LEG



**Marking on the body**



**Ordering Information**

Part Number	Package	Unit Weight	Base Quantity	Delivery mode
SRT40U150CT	TO-220AB	0.07oz(1.96g)	50 pcs / tube	1000pcs/box 5000pcs/carton
SRT40U150FCT	TO-220F	0.06oz(1.74g)	50 pcs / tube	1000pcs/box 5000pcs/carton
SRT40U150DC	TO-263	0.04oz(1.16g)	800 pcs / reel	1600pcs/box 8000pcs/carton

Note: For Halogen Free molding compound, add "H" suffix to part number above.

Package Outline Dimensions millimeters

TO-220AB

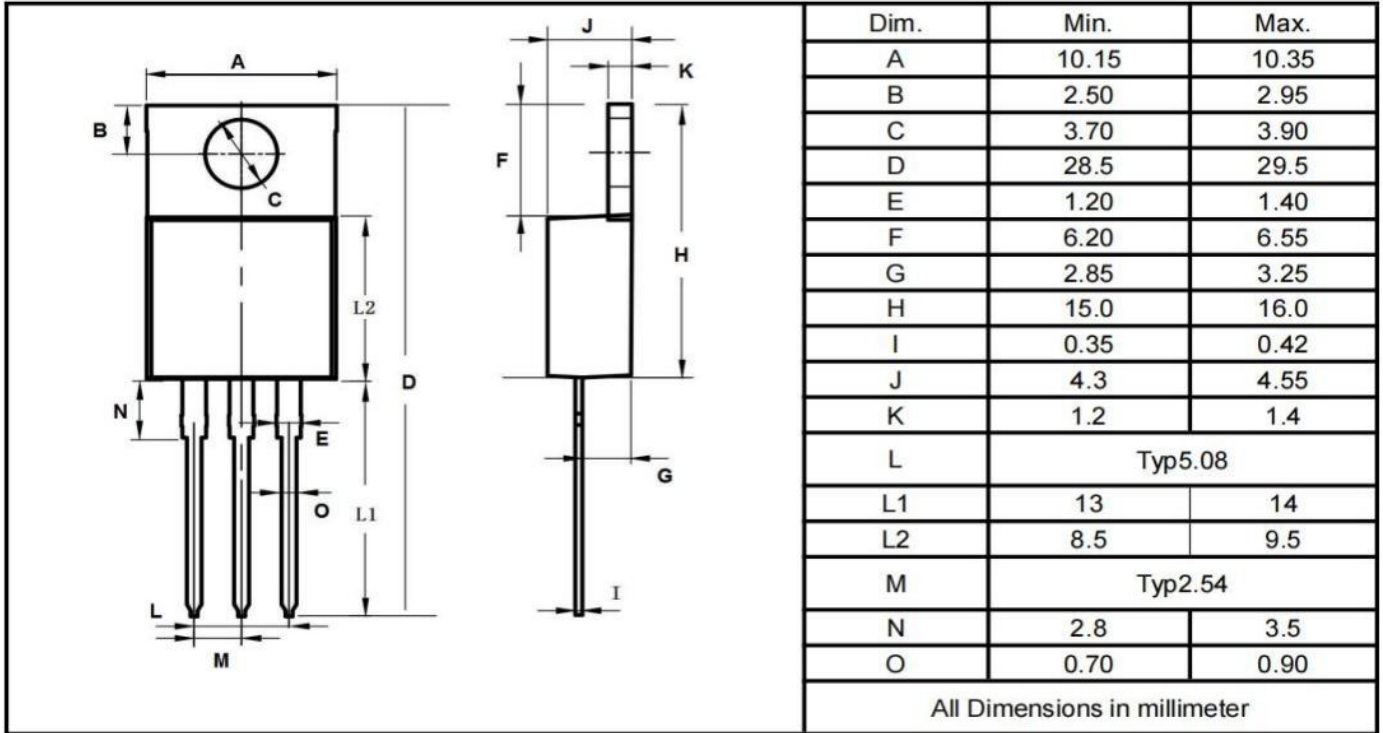

TO-220F

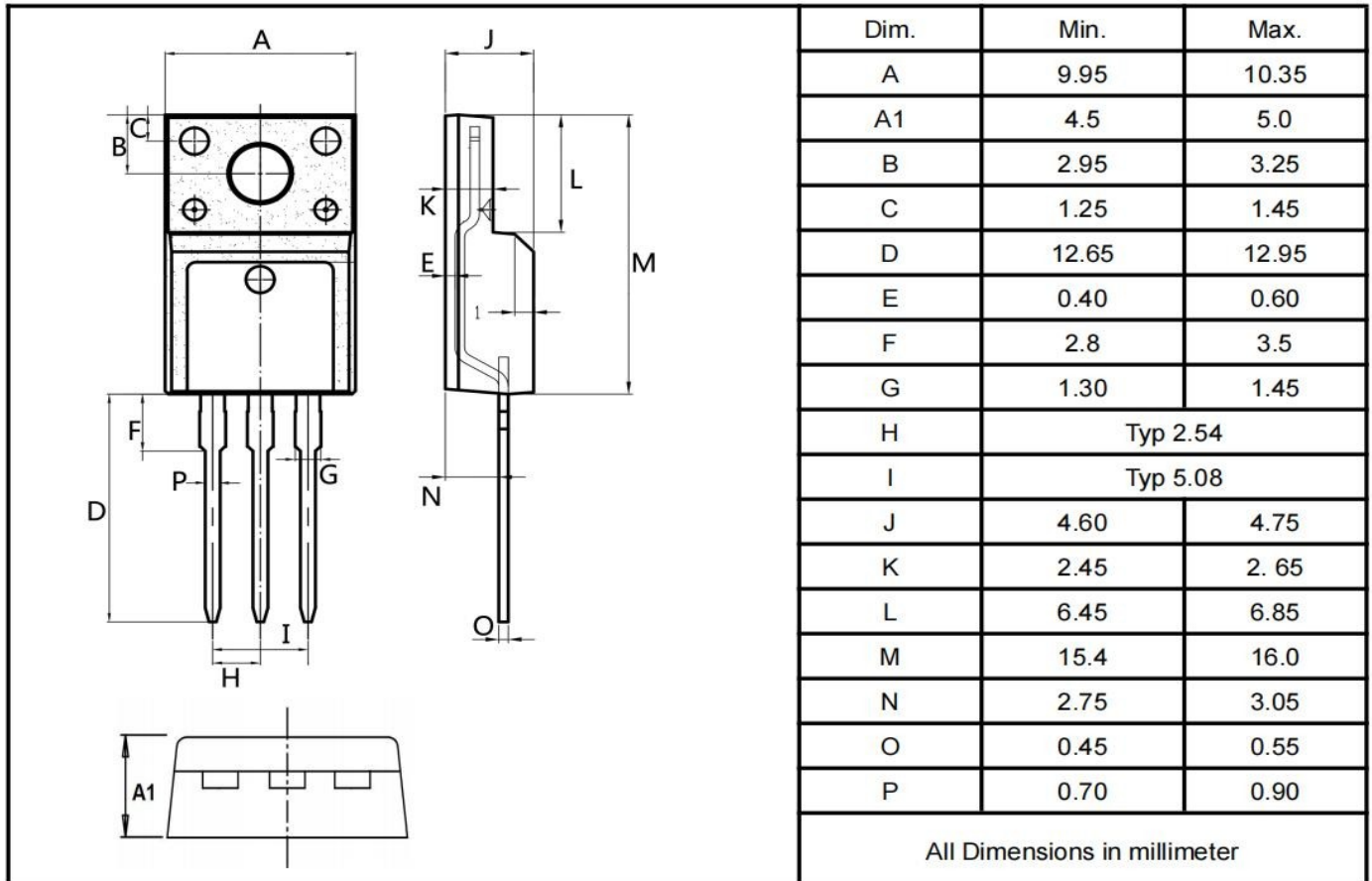

Package Outline Dimensions millimeters

TO-263

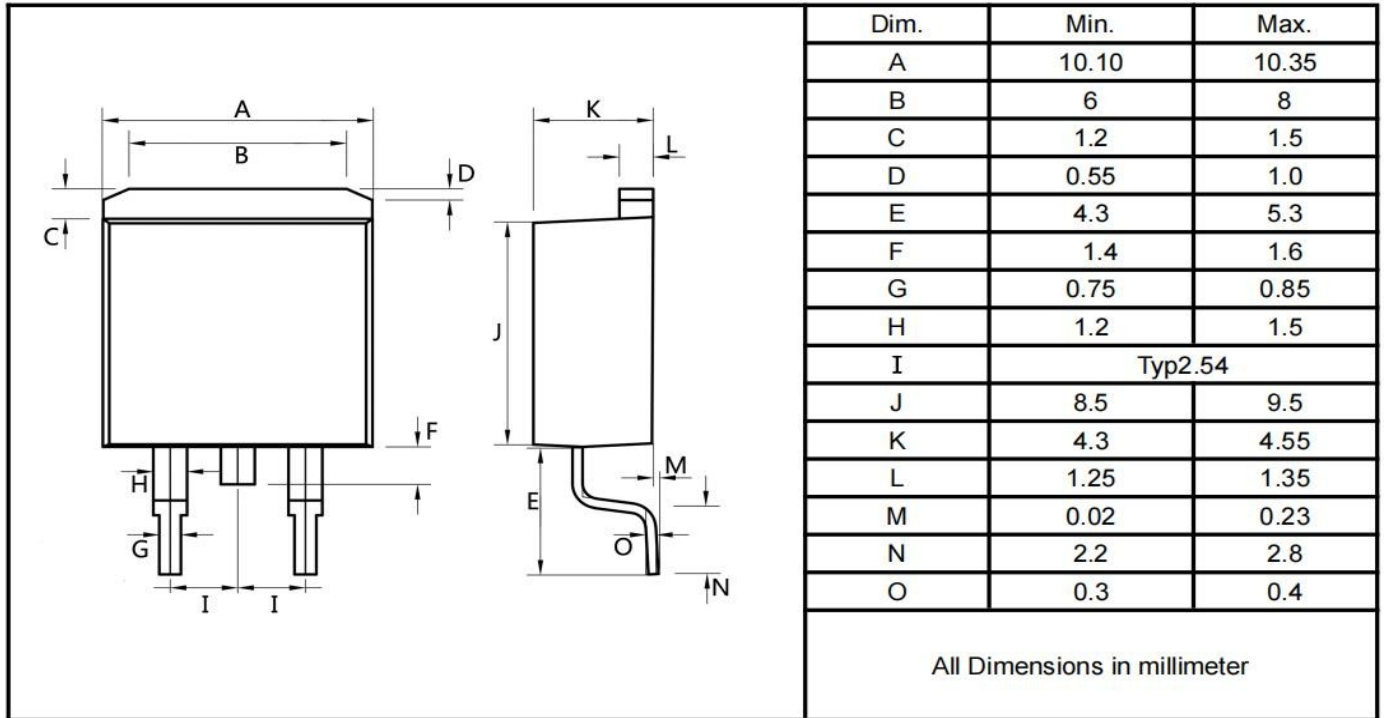

## X-ON Electronics

Largest Supplier of Electrical and Electronic Components

*Click to view similar products for [Schottky Diodes & Rectifiers](#) category:*

*Click to view products by [YFW Electronics](#) manufacturer:*

Other Similar products are found below :

[MA4E2039](#) [MMBD301M3T5G](#) [RB160M-50TR](#) [D83C](#) [BAS16E6433HTMA1](#) [BAS 3010S-02LRH E6327](#) [BAT 54-02LRH E6327](#)  
[NRVBAF360T3G](#) [NSR05F40QNXT5G](#) [NTE555](#) [JANS1N6640](#) [SS3003CH-TL-E](#) [GA01SHT18](#) [CRS10I30A\(TE85L,QM](#) [MBRA140TRPBF](#)  
[MBRB30H30CT-1G](#) [BAT 15-04R E6152](#) [JANTX1N5712-1](#) [DMJ3940-000](#) [SB007-03C-TB-E](#) [NRVBB20100CTT4G](#) [NRVBM120LT1G](#)  
[NTSB30U100CT-1G](#) [CRG04\(T5L,TEMQ\)](#) [ACDBA1100LR-HF](#) [ACDBA1200-HF](#) [ACDBA240-HF](#) [ACDBA3100-HF](#) [CDBQC0530L-HF](#)  
[ACDBA260LR-HF](#) [ACDBA1100-HF](#) [10BQ015-M3/5BT](#) [NRVBM120ET1G](#) [VSSB410S-M3/5BT](#) [1N5819T-G](#) [PDS1040Q-13](#) [B160BQ-13-F](#)  
[SDM05U20CSP-7](#) [BAS 70-07 E6433](#) [B140S1F-7](#) [HSM560Je3/TR13](#) [DDB2265-000](#) [ZHCS506QTA](#) [HSM190Je3/TR13](#) [B330AF-13](#)  
[ACDBUC0230-HF](#) [SDM1U100S1F-7](#) [MBR10200CTF-G1](#) [CDLL5712](#) [DMF2822-000](#)