

Surface Mount Schottky Barrier Rectifier

Reverse Voltage - 40 to 200 V

Forward Current - 10 A

FEATURES

- ◆The plastic package carries Underwriters Laboratory Flammability Classification 94V-0
- ◆For surface mounted applications
- ◆Built-in strain relief, ideal for automated placement
- ◆Low reverse leakage
- ◆High forward surge current capability
- ◆High temperature soldering guaranteed 250 C/10 seconds at terminals
- ◆Lead free in comply with EU RoHS 2011/65/EU directives

MECHANICAL DATA

- ◆Case: TO-277
- ◆Terminals: Solderable per MIL-STD-750, Method 2026
- ◆Approx. Weight: 0.003g / 0.092oz

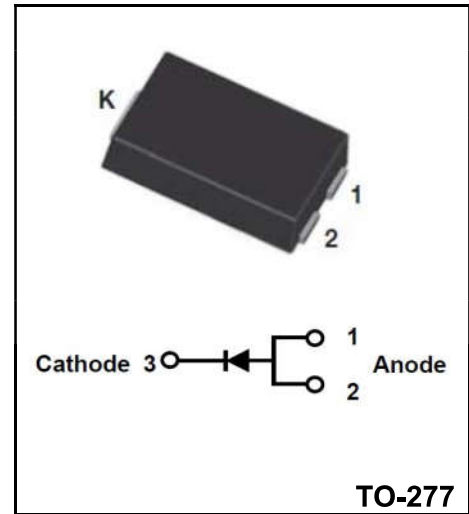

Absolute Maximum Ratings and Electrical characteristics

Ratings at 25 ° ambient temperature unless otherwise specified. Single phase, half wave, 60Hz resistive or inductive load, for capacitive load, derate by 20 %

Parameter	Symbols	SS1040SP	SS1045SP	SS1060SP	SS1080SP	SS10100SP	SS10150SP	SS10200SP	Units
Maximum Repetitive Peak Reverse Voltage	V_{RRM}	40	45	60	80	100	150	200	V
Maximum RMS voltage	V_{RMS}	28	31.5	42	56	70	105	140	V
Maximum DC Blocking Voltage	V_{DC}	40	45	60	80	100	150	200	V
Maximum Average Forward Rectified Current TL=100°C	$I_{F(AV)}$	10.0							A
Peak Forward Surge Current, 8.3ms Single Half Sine-wave Superimposed On Rated Load (JEDEC method)	I_{FSM}	175.0							A
Maximum Instantaneous Forward Voltage at 10 A	V_F	0.55	0.70	0.85	0.95				V
Maximum Instantaneous Reverse Current at Rated DC Reverse Voltage $T_A = 25^\circ C$ $T_A = 125^\circ C$	I_R	0.5 50		0.05 10					mA
Typical Thermal Resistance	$R_{\theta JA}$	60.0							°C/W
Operating Junction Temperature Range	T_j	-55 ~ +150							°C
Storage Temperature Range	T_{stg}	-55 ~ +150							°C

Ratings and Characteristic Curves

FIG. 1- DERATING CURVE OUTPUT RECTIFIED CURRENT

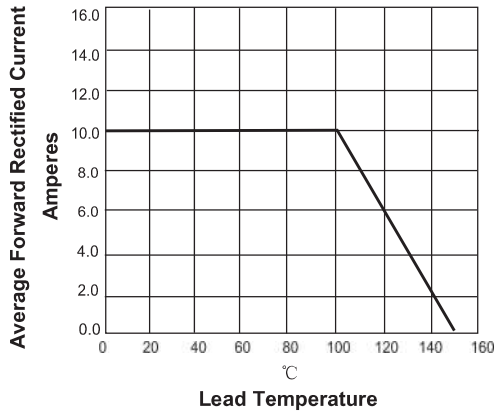

FIG. 2-MAXIMUM NON-REPETITIVE PEAK FORWARD SURGE CURRENT PER LEG

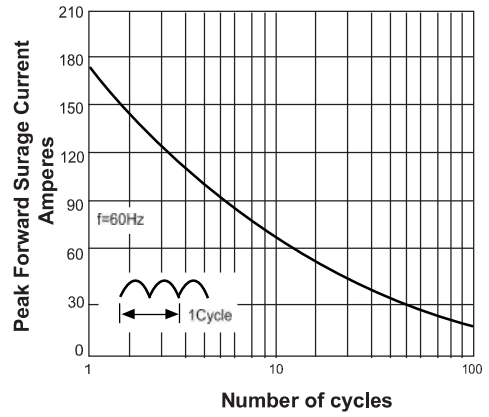

FIG. 3-TYPICAL FORWARD VOLTAGE CHARACTERISTICS

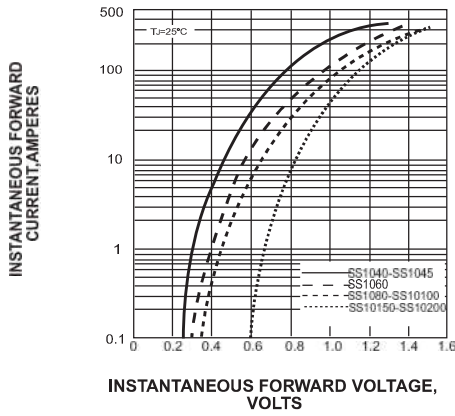
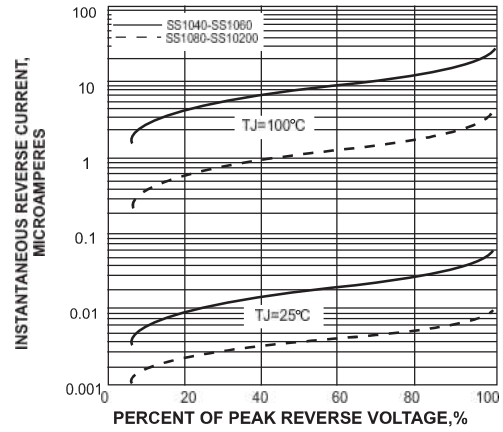
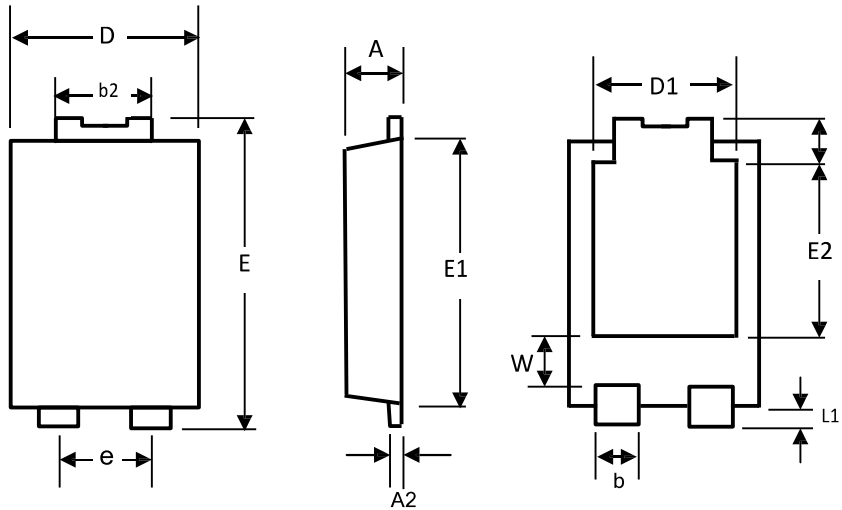

FIG. 4-TYPICAL REVERSE LEAKAGE CHARACTERISTICS



Package Outline TO-277

Plastic surface mounted package; 3 leads



Dim	Min	Max
A	1.1	1.2
A2	0.3	0.4
b1	0.8	1
b2	1.7	1.9
D	3.9	4.1
D1	3.054	
E	6.4	6.6
e	1.84	
E1	5.3	5.5
E2	3.549	
L	0.8	1
L1	0.5	0.7
W	1.1	1.4

unit:mm

Mounting Pad Layout

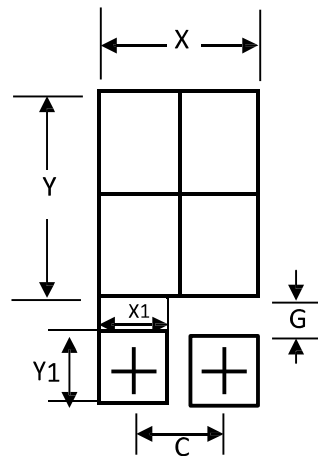

Dim	Min
C	1.8
G	0.9
X	3.4
X1	1.4
Y	4.9
Y1	1.4

unit:mm

Summary of Packing Options

Package	Packing Description	Packing Quantity	Industry Standard
TO-277	Tape/Reel,13"reel	5000	EIA-481-1

X-ON Electronics

Largest Supplier of Electrical and Electronic Components

Click to view similar products for [MOSFET](#) category:

Click to view products by [YFW Electronics](#) manufacturer:

Other Similar products are found below :

[IRFD120](#) [JANTX2N5237](#) [BUK455-60A/B](#) [MIC4420CM-TR](#) [VN1206L](#) [NDP4060](#) [SI4482DY](#) [IPS70R2K0CEAKMA1](#) [SQD23N06-31L-GE3](#)
[TK16J60W,S1VQ\(O](#) [2SK2614\(TE16L1,Q\)](#) [DMN1017UCP3-7](#) [DMN1053UCP4-7](#) [SQJ469EP-T1-GE3](#) [NTE2384](#) [DMC2700UDMQ-7](#)
[DMN2080UCB4-7](#) [DMN61D9UWQ-13](#) [US6M2GTR](#) [DMN31D5UDJ-7](#) [DMP22D4UFO-7B](#) [DMN1006UCA6-7](#) [DMN16M9UCA6-7](#)
[STF5N65M6](#) [IRF40H233XTMA1](#) [STU5N65M6](#) [DMN6022SSD-13](#) [DMN13M9UCA6-7](#) [DMTH10H4M6SPS-13](#) [DMN2990UFB-7B](#)
[IPB80P04P405ATMA2](#) [2N7002W-G](#) [MCAC30N06Y-TP](#) [MCQ7328-TP](#) [NTMC083NP10M5L](#) [BXP7N65D](#) [BXP4N65F](#) [AOL1454G](#)
[WMJ80N60C4](#) [BXP2N20L](#) [BXP2N65D](#) [BXT1150N10J](#) [BXT1700P06M](#) [TSM60NB380CP](#) [ROG](#) [RQ7L055BGTGR](#) [DMNH15H110SK3-13](#)
[SLF10N65ABV2](#) [BSO203SP](#) [BSO211P](#) [IPA60R230P6](#)