

Surface Mount Schottky Barrier Rectifier

Reverse Voltage - 20 to 200 V

Forward Current - 2 A

FEATURES

- ◆Metal silicon junction, majority carrier conduction
- ◆For surface mounted applications
- ◆Low power loss, high efficiency
- ◆High forward surge current capability
- ◆For use in low voltage, high frequency inverters, free wheeling, and polarity protection applications
- ◆Lead free in comply with EU RoHS 2011/65/EU directives



MECHANICAL DATA

- ◆Case: SMAF
- ◆Terminals: Solderable per MIL-STD-750, Method 2026
- ◆Approx. Weight: 27mg / 0.00095oz

Pinning

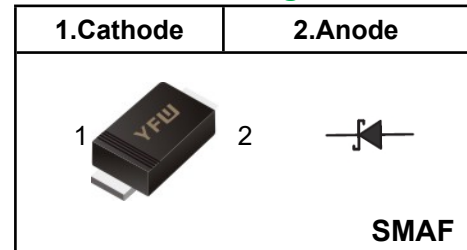

Marking Code

SS22F	SS22
SS24F	SS24
SS26F	SS26
SS28F	SS28
SS210F	SS210
SS212F	SS212
SS215F	SS215
SS220F	SS220

Absolute Maximum Ratings and Electrical characteristics

Ratings at 25 ° ambient temperature unless otherwise specified. Single phase, half wave, 60Hz resistive or inductive load, for capacitive load, derate by 20 %

Parameter	Symbols	SS22F	SS24F	SS26F	SS28F	SS210F	SS212F	SS215F	SS220F	Units
Maximum Repetitive Peak Reverse Voltage	V_{RRM}	20	40	60	80	100	120	150	200	V
Maximum RMS voltage	V_{RMS}	14	28	42	56	70	84	105	140	V
Maximum DC Blocking Voltage	V_{DC}	20	40	60	80	100	120	150	200	V
Maximum Average Forward Rectified Current	$I_{F(AV)}$	2.0								A
Peak Forward Surge Current, 8.3ms Single Half Sine-wave Superimposed On Rated Load (JEDEC method)	I_{FSM}	50				40				A
Maximum Instantaneous Forward Voltage at 2 A	V_F	0.55	0.70		0.85		0.95		V	
Maximum Instantaneous Reverse Current at Rated DC Reverse Voltage <small>$T_A = 25^{\circ}C$ $T_A = 100^{\circ}C$</small>	I_R	0.5 5			0.3 3				mA	
Typical Junction Capacitance ⁽¹⁾	C_j	160			80				pF	
Typical Thermal Resistance ⁽²⁾	$R_{\theta JA}$	80								°C/W
Operating Junction Temperature Range	T_j	-55 ~ +150								°C
Storage Temperature Range	T_{stg}	-55 ~ +150								°C

(1) Measured at 1 MHz and applied reverse voltage of 4 V D.C

(2) P.C.B. mounted with 2.0" X 2.0" (5 X 5 cm) copper pad areas.

Fig.1 Forward Current Derating Curve

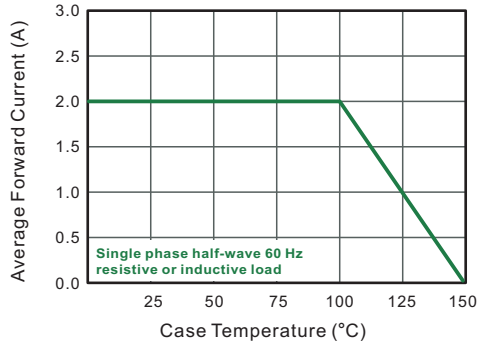

Fig.2 Typical Reverse Characteristics

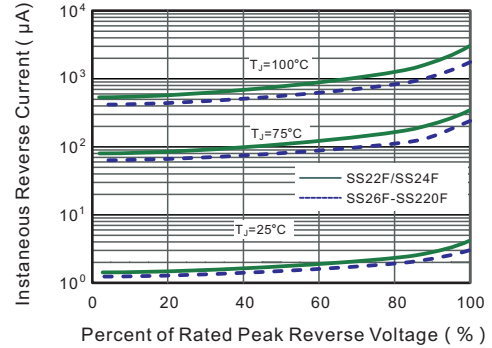

Fig.3 Typical Forward Characteristic

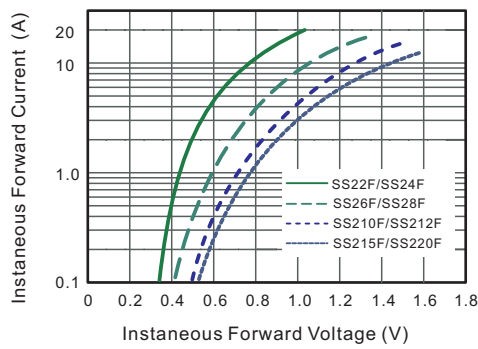

Fig.4 Typical Junction Capacitance

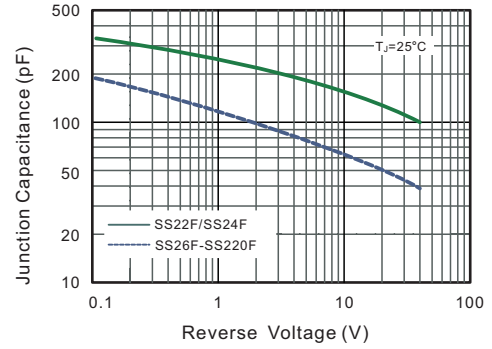

Fig.5 Maximum Non-Repetitive Forward Surge Current

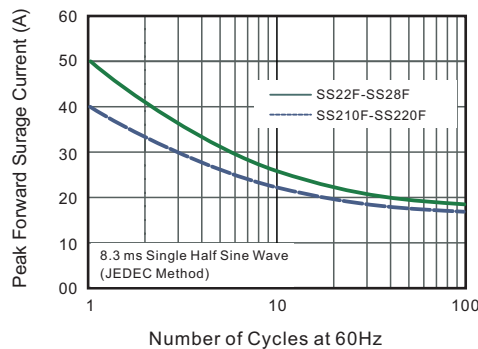
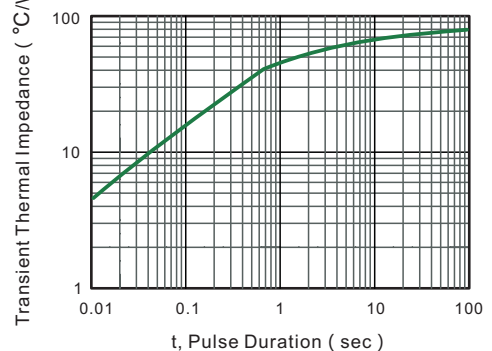

Fig.6- Typical Transient Thermal Impedance



Package Outline

SMAF

Plastic surface mounted package; 2 leads

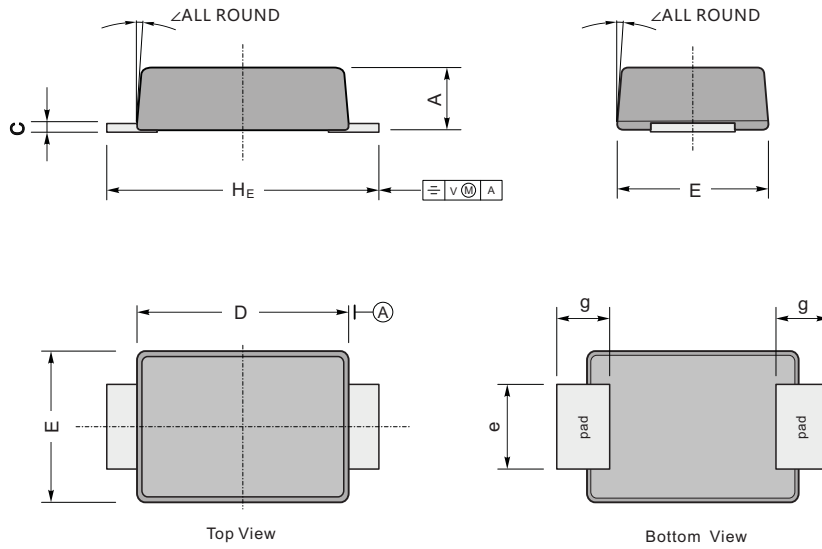

UNIT		A	C	D	E	e	g	H _E	\angle
mm	max	1.1	0.20	3.7	2.7	1.6	1.2	4.9	7°
	min	0.9	0.12	3.3	2.4	1.3	0.8	4.4	
mil	max	43	7.9	146	106	63	47	193	
	min	35	4.7	130	94	51	31	173	

The recommended mounting pad size

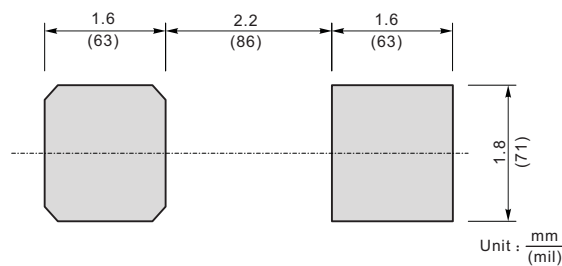

Summary of Packing Options

Package	Packing Description	Packing Quantity	Industry Standard
SMAF	Tape/Reel, 13" reel	10000	EIA-481-1
	Tape/Reel, 7" reel	3000	EIA-481-1

X-ON Electronics

Largest Supplier of Electrical and Electronic Components

Click to view similar products for [Schottky Diodes & Rectifiers](#) category:

Click to view products by [YFW Electronics](#) manufacturer:

Other Similar products are found below :

[MA4E2039](#) [MA4E2508M-1112](#) [MBR0530L-TP](#) [MBR10100CT-BP](#) [MBR1545CT](#) [MMBD301M3T5G](#) [RB160M-50TR](#)
[BAS16E6433HTMA1](#) [BAS 3010S-02LRH E6327](#) [BAT 54-02LRH E6327](#) [IDL02G65C5XUMA1](#) [NSR05F40QNXT5G](#) [NSVR05F40NXT5G](#)
[NTE555](#) [JANS1N6640](#) [SB07-03C-TB-H](#) [SK310-T](#) [SK33A-TP](#) [SK34B-TP](#) [SS3003CH-TL-E](#) [PDS3100Q-7](#) [GA01SHT18](#)
[CRS10I30A\(TE85L,QM](#) [MA4E2501L-1290](#) [MBRB30H30CT-1G](#) [JANTX1N5712-1](#) [SB007-03C-TB-E](#) [SK33B-TP](#) [SK35A-TP](#) [SK38B-LTP](#)
[NTE505](#) [NTSB30U100CT-1G](#) [VS-6CWQ10FNHM3](#) [CRG04\(T5L,TEMQ\)](#) [ACDBA1100LR-HF](#) [ACDBA1200-HF](#) [ACDBA240-HF](#)
[ACDBA3100-HF](#) [CDBQC0530L-HF](#) [ACDBA260LR-HF](#) [ACDBA1100-HF](#) [MA4E2502L-1246](#) [10BQ015-M3/5BT](#) [10BQ060-M3/5BT](#)
[NRVB130LSFT1G](#) [CRS08TE85LQM](#) [PMAD1108-LF](#) [B120Q-13-F](#) [1N5819T-G](#) [B0530WSQ-7-F](#)