

**NPN Silicon Epitaxial Planar Transistor**

**Features**

- ◆ High voltage
- ◆ High speed switching

**APPLICATIONS**

- ◆ High Speed Switching
- ◆ Suitable for Switching Regulator and Motor Control

**Mechanical Data**

- ◆ Case: Molded plastic
- ◆ Polarity: As marked
- ◆ Mounting Position: Any
- ◆ Molded Plastic: UL Flammability Classification Rating 94V-0
- ◆ Lead free in compliance with EU RoHS 2011/65/EU directive
- ◆ Solder bath temperature 275°C maximum, 10s per JESD 22- B106

**Product Specification Classification**

Part Number	Package	Marking	Pack
YFW13007AT	TO-220AB	YFW 13007AT XXXXX	1000PCS/box
YFW13007AF	TO-220F	YFW 13007AF XXXXX	1000PCS/box
YFW13007AS	TO-263	YFW 13007AS XXXXX	800PCS/Reel

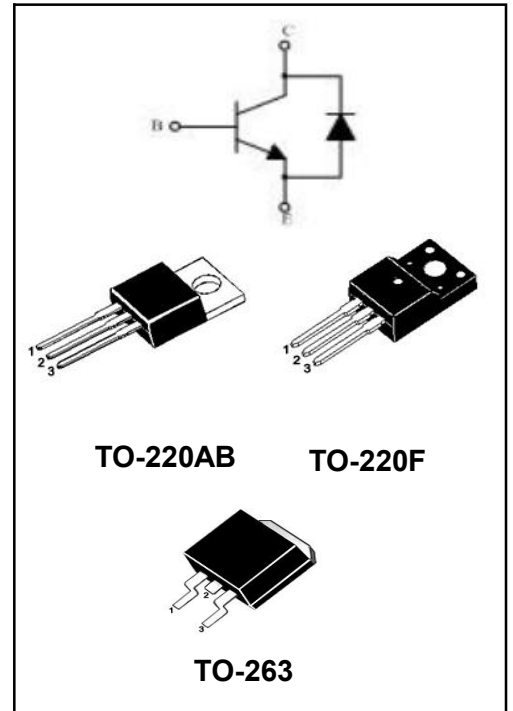

**Maximum Ratings at Ta=25°C unless otherwise specified**

Characteristics	Symbol	Value	Unit
Collector Base Voltage	$V_{CBO}$	700	V
Collector Emitter Voltage	$V_{CEO}$	400	V
Emitter Base Voltage	$V_{EBO}$	9	V
Collector Current	$I_C$	8	A
Power Dissipation (Tc = 25 °C ) Superimposed on Rated Load (JEDEC method)	$P_{tot}$	2	W
Operating Temperature Range	$T_J$	150	°C
Storage Temperature Range	$T_{STG}$	-55 to +150	°C

**Electrical Characteristics(Ta=25°C)**

Parameter	Symbol	Min.	Typ.	Max.	Unit
DC Current Gain at $V_{CE} = 5V, I_C = 2A$	$h_{FE}$	8	-	40	-
Collector Base Cutoff Current at $V_{CB} = 700V$	$I_{CBO}$	-	-	10	$\mu A$
Collector Emitter Cutoff Current at $V_{CE} = 400V$	$I_{CEO}$	-	-	10	$\mu A$
Emitter Base Cutoff Current at $V_{EB} = 9V$	$I_{EBO}$	-	-	10	$\mu A$
Collector Emitter Saturation Voltage at $I_C = 2A, I_B = 400mA$	$V_{CE(sat)}$	-	-	1	V
Base Emitter Saturation Voltage at $I_C = 2A, I_B = 400mA$	$V_{BE(sat)}$	-	-	1.2	V
Transition Frequency at $V_{CE}=10V, I_C=500mA, f=1MHZ$	$f_T$	4	-	-	MHZ

Ratings And Characteristic Curves

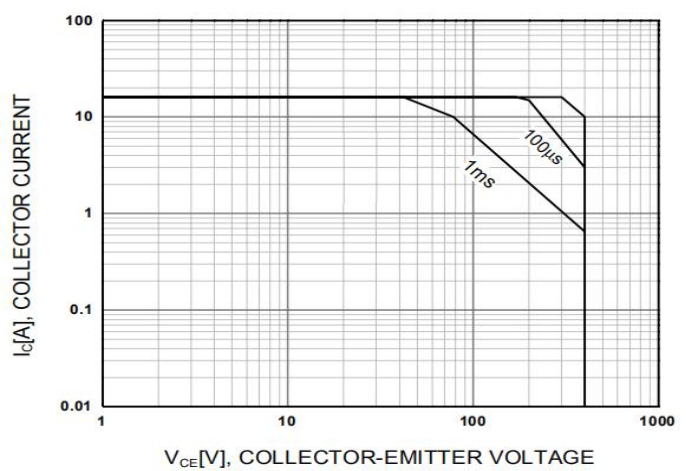
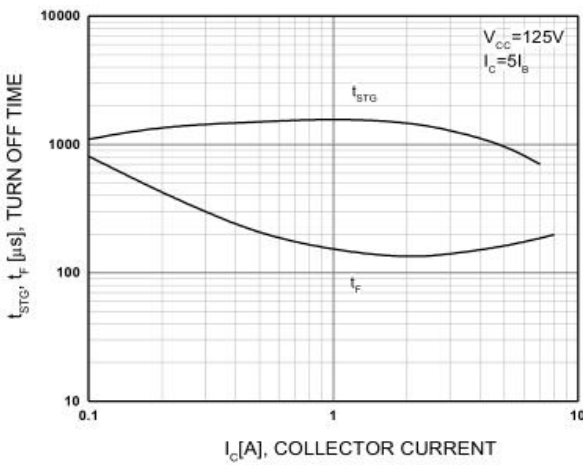
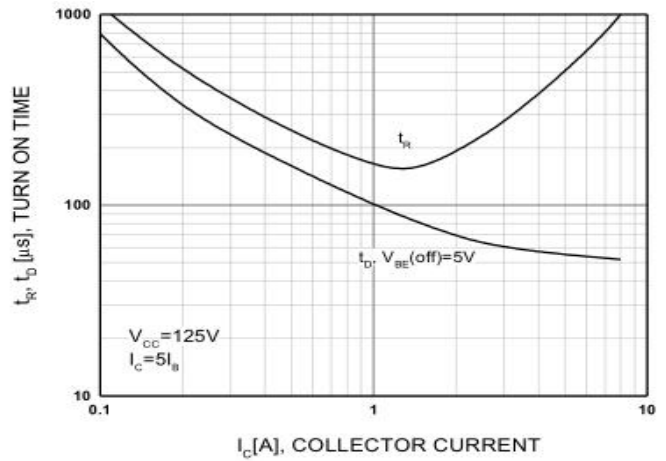
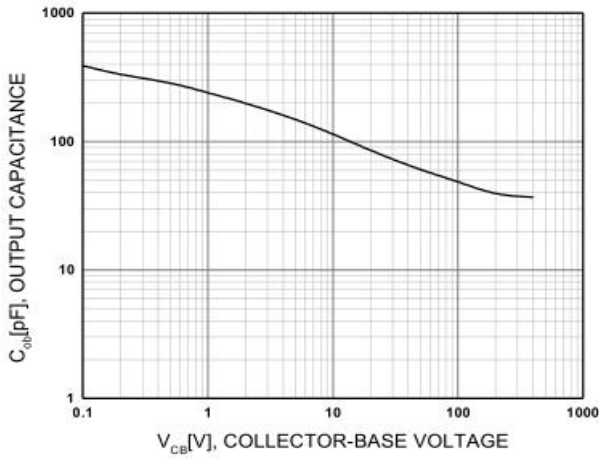
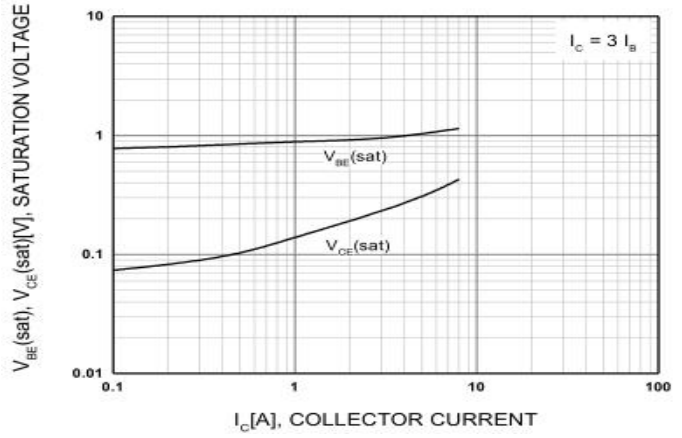
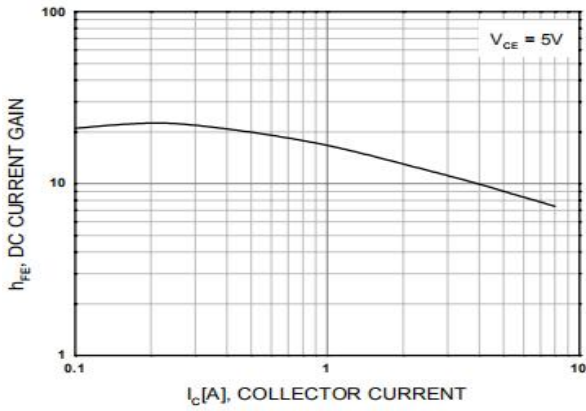

Package Outline Dimensions millimeters

TO-220AB

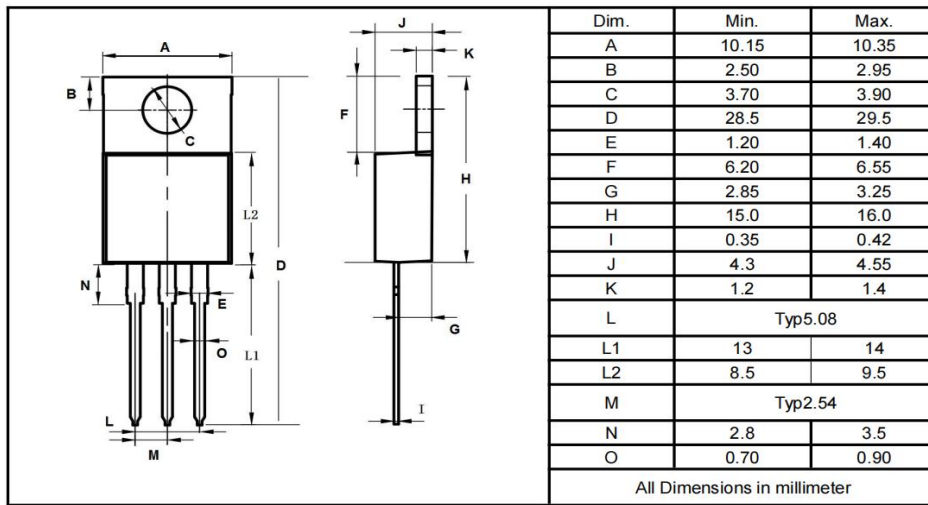

TO-220F

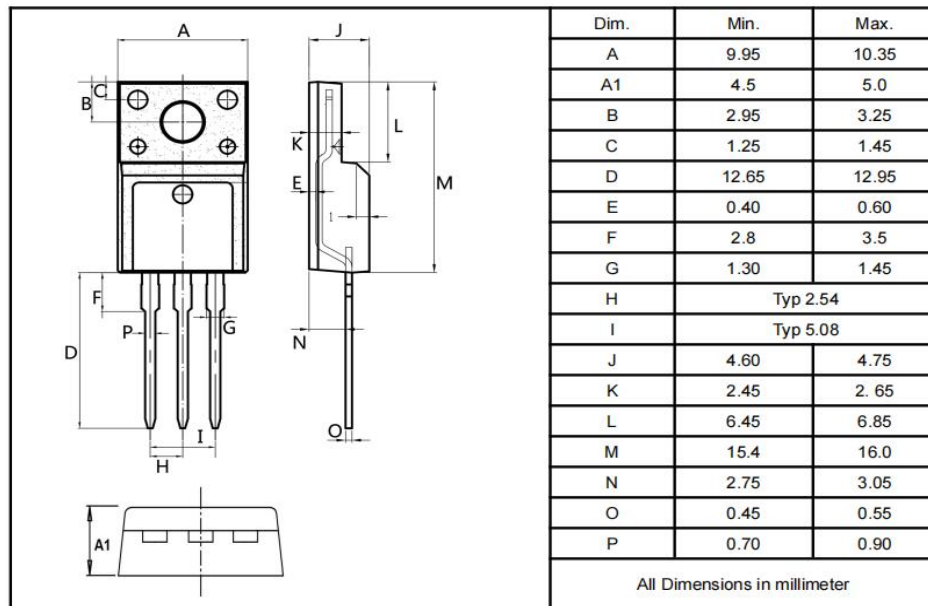

TO-263

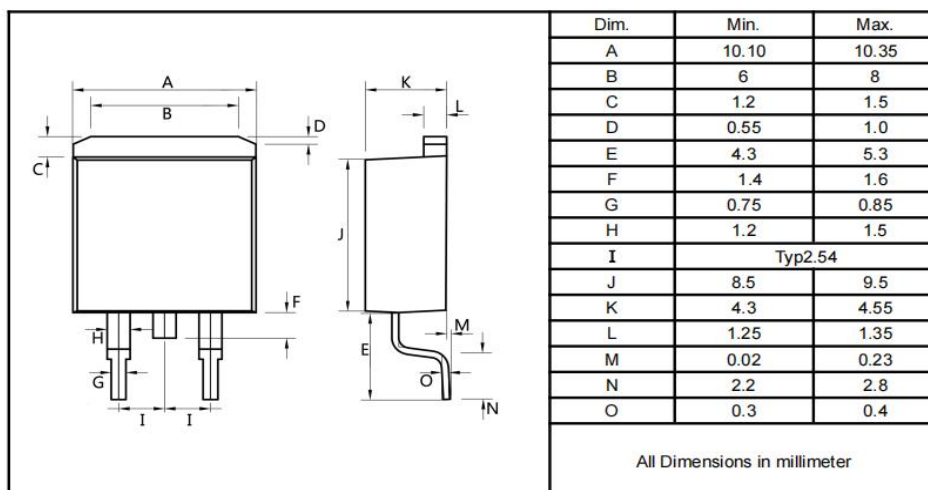

## X-ON Electronics

Largest Supplier of Electrical and Electronic Components

*Click to view similar products for [Bipolar Transistors - BJT category](#):*

*Click to view products by [YFW Electronics manufacturer](#):*

Other Similar products are found below :

[BC559C](#) [MCH4017-TL-H](#) [MMBT-2369-TR](#) [BC546/116](#) [NJVMJD148T4G](#) [NTE16](#) [NTE195A](#) [IMX9T110](#) [2N4401-A](#) [2N6728](#) [2SA1419T-TD-H](#) [2SB1204S-TL-E](#) [2SC5488A-TL-H](#) [FMC5AT148](#) [2N2369ADCSM](#) [2N2907A](#) [2N3904-NS](#) [2N5769](#) [2SC4618TLN](#) [CPH6501-TL-E](#) [US6T6TR](#) [BAX18/A52R](#) [BC556/112](#) [IMZ2AT108](#) [MMST8098T146](#) [MCH6102-TL-E](#) [BC846B-13-F](#) [2N3879](#) [30A02MH-TL-E](#) [NTE13](#) [NTE282](#) [NTE323](#) [NTE350](#) [NTE81](#) [JANTX2N2920L](#) [JANSR2N2907AUB](#) [CMLT3946EG TR](#) [SNSS40600CF8T1G](#) [CMLT3906EG TR](#) [GRP-DATA-JANS2N2907AUB](#) [GRP-DATA-JANS2N2222AUA](#) [MMDT3946FL3-7](#) [2N4240](#) [JANS2N3019](#) [MSB30KH-13](#) [2N2221AUB](#) [2SD1815T-TL-E](#) [2N6678](#) [2N2907Ae4](#) [JAN2N3507](#)