

-30V P-CHANNEL ENHANCEMENT MODE MOSFET

MAIN CHARACTERISTICS

I_D	-12A
V_{DSS}	-30V
R_{DS(on)-typ(@V_{GS}=-10V)}	< 13mΩ (Type:10 mΩ)

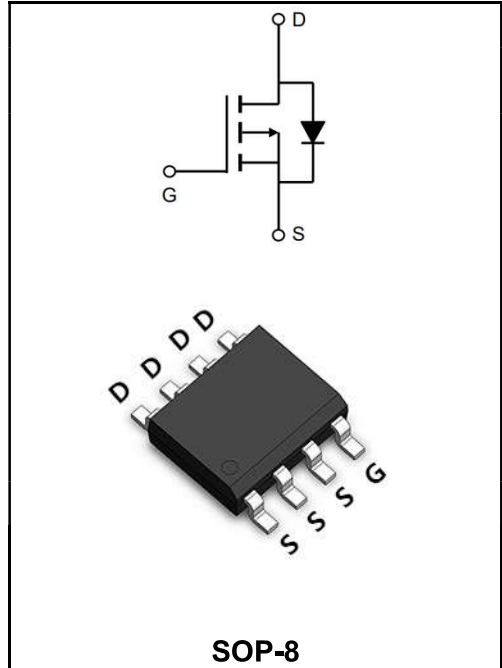

Application

- ◆ Battery protection
- ◆ Load switch
- ◆ Uninterruptible power supply

Product Specification Classification

Part Number	Package	Marking	Pack
YFW4407AS	SOP-8	YFW 4407AS XXXXX	3000PCS/Tape

Maximum Ratings at Tc=25°C unless otherwise specified

Characteristics	Symbols	Value	Units
Drain-Source Voltage	V_{DS}	-30	V
Gate - Source Voltage	V_{GS}	±20	V
Continuous Drain Current, V _{GS} @ -10V ¹ @T _A =25°C	I_D	-12	A
Continuous Drain Current, V _{GS} @ -10V ¹ @T _A =70°C	I_D	-9.5	A
Pulsed Drain Current ²	I_{DM}	-50	A
Single Pulse Avalanche Energy ³	E_{AS}	125	mJ
Avalanche Current	I_{AS}	-50	A
Total Power Dissipation ⁴ @T _A =25°C	P_D	1.5	W
Storage Temperature Range	T_{STG}	-55 to +150	°C
Operating Junction Temperature Range	T_J	-55 to +150	°C
Thermal Resistance Junction-Ambient ¹	R_{θJA}	75	°C/W
Thermal Resistance Junction-Ambient ¹ (t≤10s)	R_{θJA}	40	°C/W
Thermal Resistance Junction to Case ¹	R_{θJC}	24	°C/W

Maximum Ratings at Tc=25°C unless otherwise specified

Characteristics	Test Condition	Symbols	Min	Typ	Max	Units
Drain-Source Breakdown Voltage	$V_{GS}=0V, I_D=-250\mu A$	BV_{DSS}	-30	-	-	V
BV_{DSS} Temperature Coefficient	Reference to 25°C, $I_D=-1mA$	$\Delta BV_{DSS}/\Delta T_J$	-	-0.023	-	V/°C
Static Drain-Source On-Resistance ²	$V_{GS}=-10V, I_D=-10A$	$R_{DS(ON)}$	-	10	13	mΩ
	$V_{GS}=-4.5V, I_D=-10A$		-	16	20	
Gate -Threshold Voltage	$V_{DS}=V_{GS}, I_D=-250\mu A$	$V_{GS(th)}$	-1.0	-1.6	-2.5	V
$V_{GS(th)}$ Temperature Coefficient		$\Delta V_{GS(th)}$	-	4.6	-	mV/°C
Drain-Source Leakage Current	$V_{DS}=-24V, V_{GS}=0V, T_J=25^\circ C$	I_{DSS}	-	-	1	μA
	$V_{DS}=-24V, V_{GS}=0V, T_J=55^\circ C$		-	-	-5	
Gate -Source Leakage Current	$V_{GS}=\pm 20V, V_{DS}=0V$	I_{GSS}	-	-	±100	nA
Forward Transconductance	$V_{DS}=-5V, I_D=-10A$	g_{fs}	-	24	-	S
Gate Resistance	$V_{DS}=0V, V_{GS}=0V, f=1MHz$	R_g	-	9	-	Ω
Total Gate Charge(-4.5V)	$V_{DS}=-15V$ $V_{GS}=-4.5V$ $I_D=-10A$	Q_g	-	20	-	nC
Gate-Source Charge		Q_{gs}	-	5.1	-	
Gate-Drain Charge		Q_{gd}	-	7.3	-	
Turn-on delay time	$V_{DD}=-15V$ $V_{GS}=-10V$ $I_D=-1A$ $R_G=3.3$	$t_{d(on)}$	-	33.8	-	ns
Rise Time		T_r	-	35.8	-	
Turn-Off Delay Time		$t_{d(OFF)}$	-	72.8	-	
Fall Time		t_f	-	10.6	-	
Input Capacitance	$V_{DS}=-15V$ $V_{GS}=0V$ $f=1MHz$	C_{iss}	-	2215	-	pF
Output Capacitance		C_{oss}	-	310	-	
Reverse Transfer Capacitance		C_{rss}	-	237	-	
Continuous Source Current ^{1,5}	$V_G=V_D=0V, \text{ Force Current}$	I_S	-	-	-11.5	A
Pulsed Source Current ^{2,5}		I_{SM}	-	-	-46	A
Diode Forward Voltage ²	$V_{GS}=0V, I_S=-1A, T_J=25^\circ C$	V_{SD}	-	-	-1	V

Note :

- 1.The data tested by surface mounted on a 1 inch² FR-4 board with 2OZ copper.
- 2.The data tested by pulsed , pulse width $\leq 300\mu s$, duty cycle $\leq 2\%$
- 3.The EAS data shows Max. rating . The test condition is $V_{DD}=-25V, V_{GS}=-10V, L=0.1mH, I_{AS}=-50A$
- 4.The power dissipation is limited by 150°C junction temperature
- 5.The data is theoretically the same as I_D and I_{DM} , in real applications , should be limited by total power dissipation.

Ratings and Characteristic Curves

Typical Characteristics

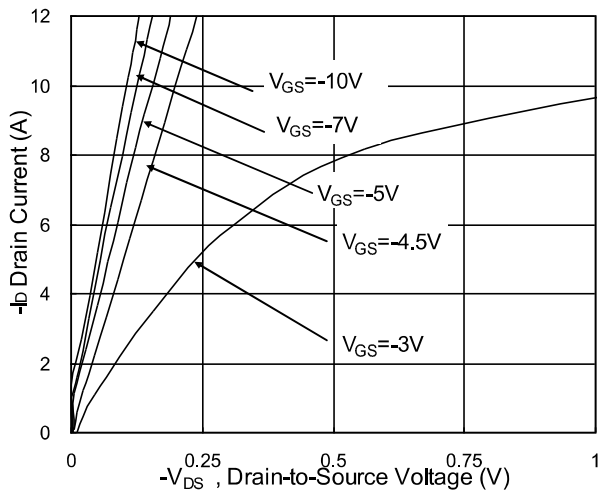

Fig.1 Typical Output Characteristics

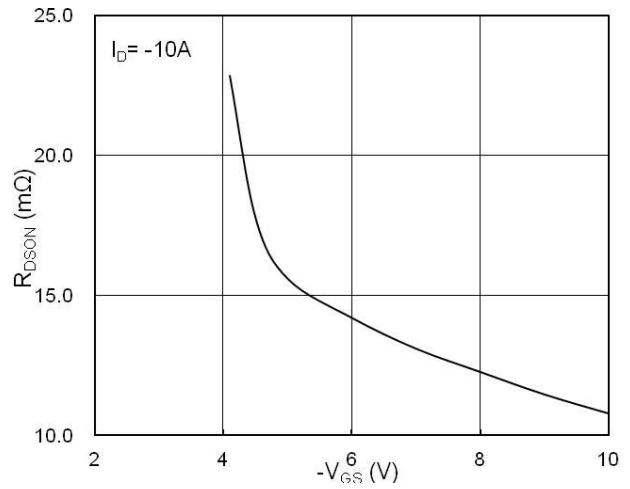

Fig.2 On-Resistance vs. G-S Voltage

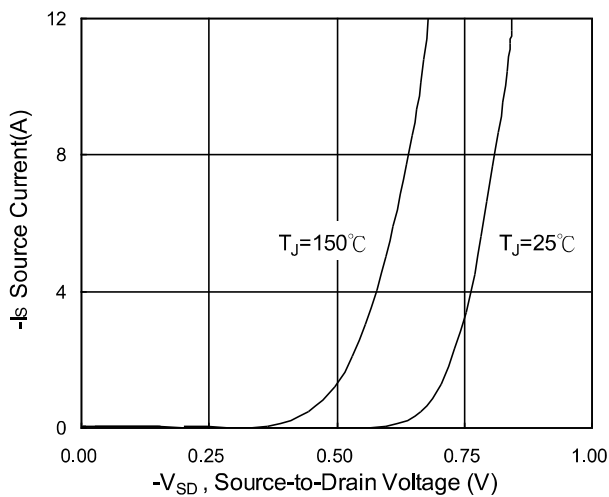

Fig.3 Forward Characteristics of Reverse

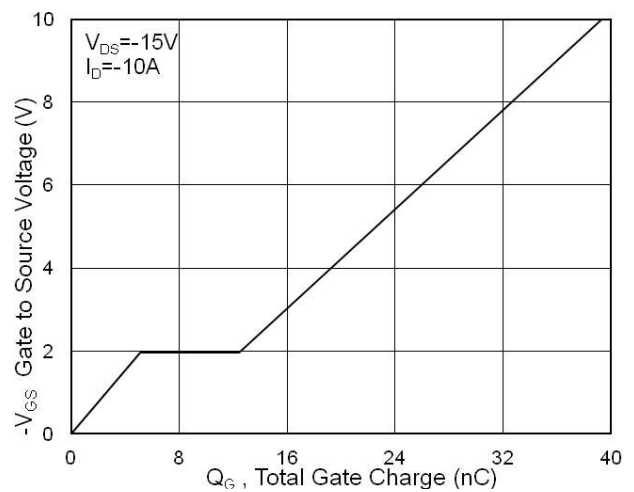

Fig.4 Gate-charge Characteristics

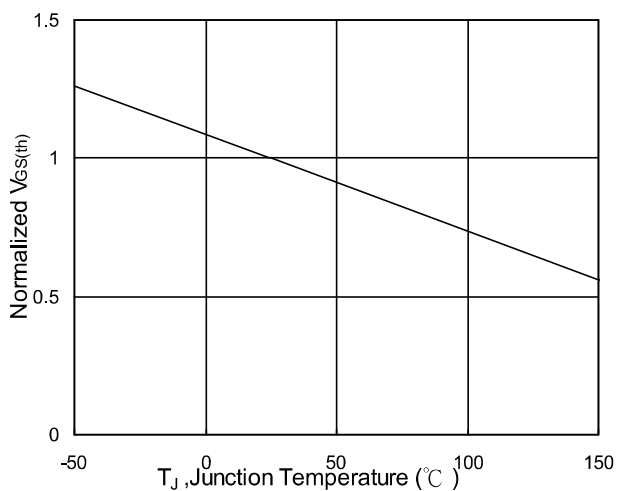

Fig.5 Normalized $V_{GS(th)}$ vs. T_J

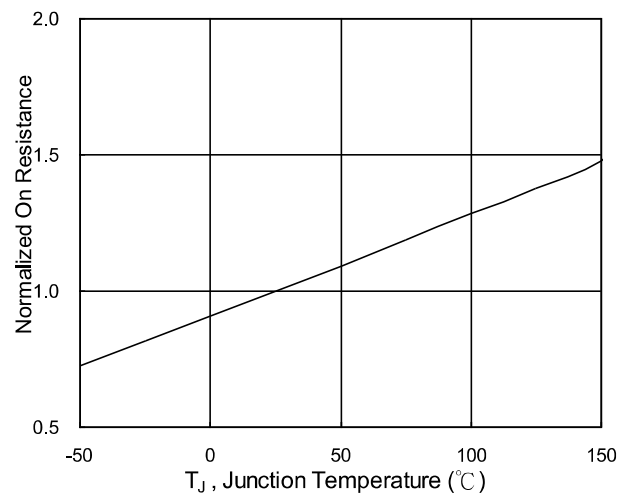

Fig.6 Normalized $R_{DS(on)}$ vs. T_J

Ratings and Characteristic Curves

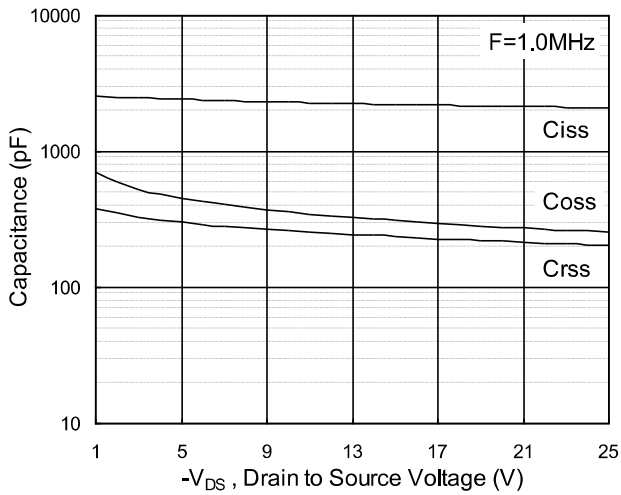

Fig.7 Capacitance

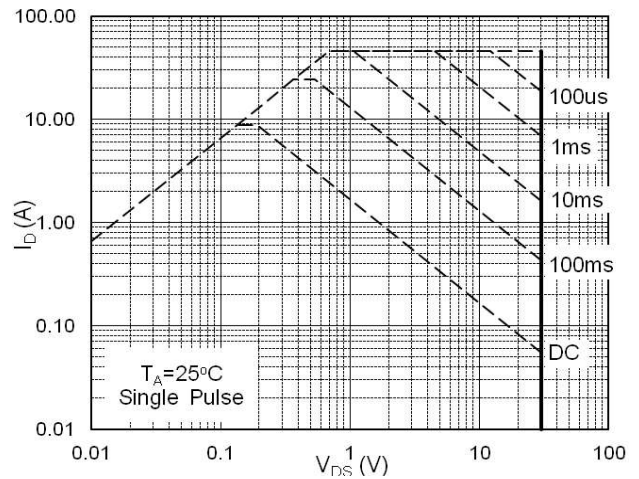

Fig.8 Safe Operating Area

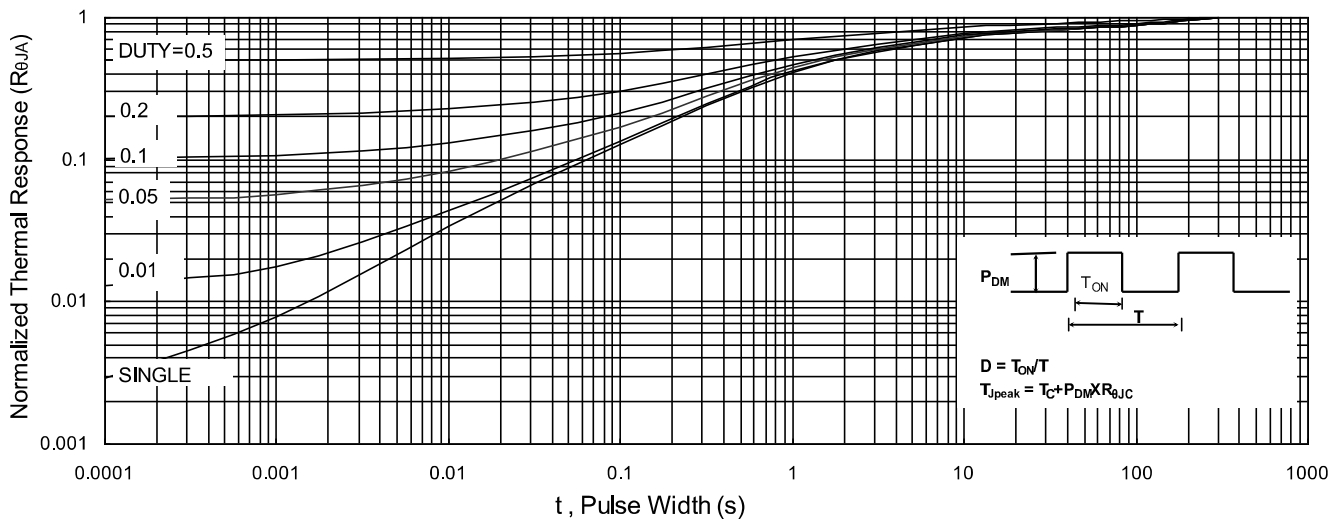

Fig.9 Normalized Maximum Transient Thermal Impedance

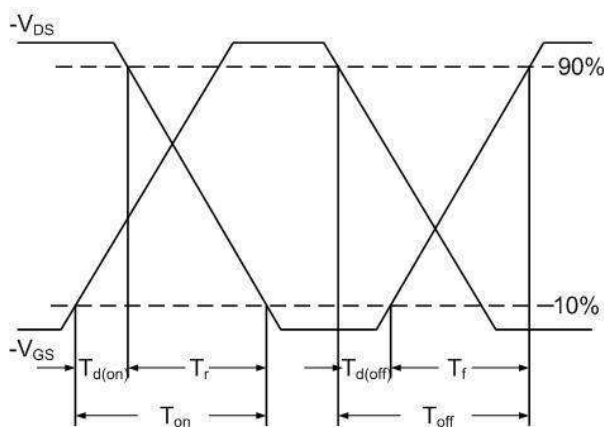

Fig.10 Switching Time Waveform

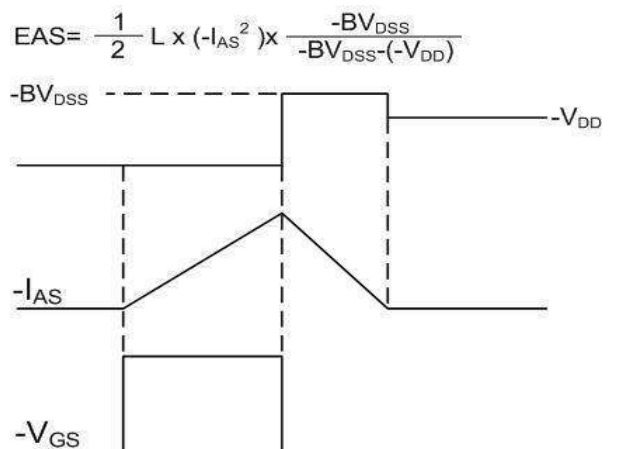
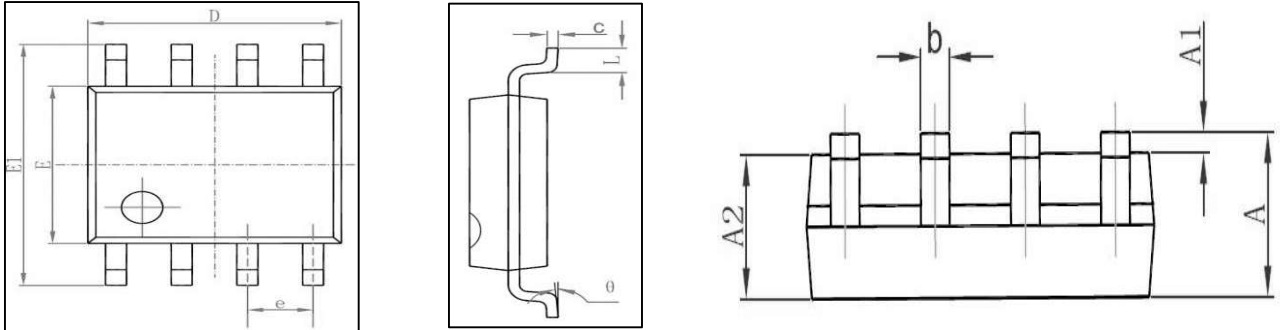
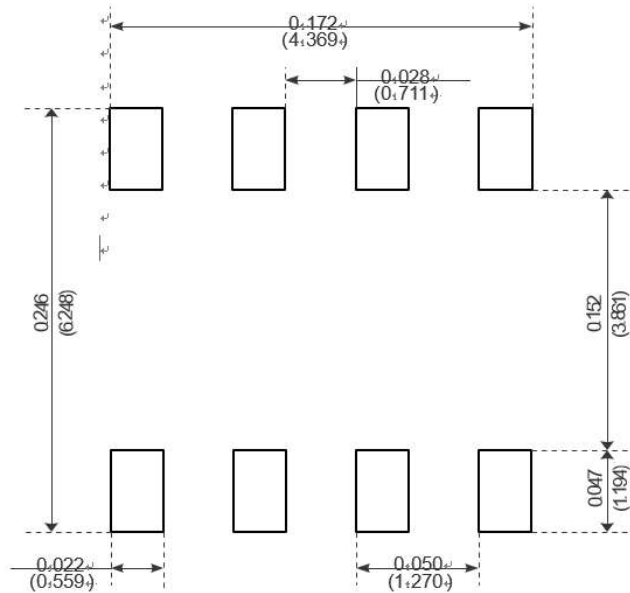

Fig.11 Unclamped Inductive Waveform

SOP-8



Symbol	Dimensions In Millimeters		Dimensions In Inches	
	Min	Max	Min	Max
A	1.350	1.750	0.053	0.069
A1	0.100	0.250	0.004	0.010
A2	1.350	1.550	0.053	0.061
b	0.330	0.510	0.013	0.020
c	0.170	0.250	0.006	0.010
D	4.700	5.100	0.185	0.200
E	3.800	4.000	0.150	0.157
E1	5.800	6.200	0.228	0.244
e	1.270 (BSC)		0.050 (BSC)	
L	0.400	1.270	0.016	0.050
θ	0°	8°	0°	8°



Recommended Minimum Pads

X-ON Electronics

Largest Supplier of Electrical and Electronic Components

Click to view similar products for [MOSFET](#) category:

Click to view products by [YFW Electronics](#) manufacturer:

Other Similar products are found below :

[IRFD120](#) [JANTX2N5237](#) [2SK2267\(Q\)](#) [BUK455-60A/B](#) [TK100A10N1,S4X\(S](#) [MIC4420CM-TR](#) [VN1206L](#) [NDP4060](#) [SI4482DY](#)
[IRS2092STRPBF-EL](#) [IPS70R2K0CEAKMA1](#) [TK31J60W5,S1VQ\(O](#) [TK31J60W,S1VQ\(O](#) [TK16J60W,S1VQ\(O](#) [2SK2614\(TE16L1,Q\)](#)
[DMN1017UCP3-7](#) [EFC2J004NUZTDG](#) [P85W28HP2F-7071](#) [DMN1053UCP4-7](#) [NTE2384](#) [DMC2700UDMQ-7](#) [DMN2080UCB4-7](#)
[DMN61D9UWQ-13](#) [US6M2GTR](#) [DMN31D5UDJ-7](#) [DMP22D4UFO-7B](#) [IPS60R3K4CEAKMA1](#) [DMN1006UCA6-7](#) [DMN16M9UCA6-7](#)
[STF5N65M6](#) [IRF40H233XTMA1](#) [STU5N65M6](#) [DMN6022SSD-13](#) [DMN13M9UCA6-7](#) [DMTH10H4M6SPS-13](#) [IPS60R360PFD7SAKMA1](#)
[DMN2990UFB-7B](#) [SSM3K35CT,L3F](#) [IPLK60R1K0PFD7ATMA1](#) [2N7002W-G](#) [MCAC30N06Y-TP](#) [IPWS65R035CFD7AXKSA1](#)
[MCQ7328-TP](#) [SSM3J143TU,LXHF](#) [PJMF280N65E1_T0_00201](#) [PJMF380N65E1_T0_00201](#) [PJMF280N60E1_T0_00201](#)
[PJMF600N65E1_T0_00201](#) [PJMF900N65E1_T0_00201](#) [PJMF900N60E1_T0_00201](#)