

30V N+P-CHANNEL ENHANCEMENT MODE MOSFET

MAIN CHARACTERISTICS

I_D	10A
V_{DSS}	30V
$R_{DS(on)-typ}(@V_{GS}=10V)$	< 25mΩ (Type:20 mΩ)
I_D	-7.6A
V_{DSS}	-30V
$R_{DS(on)-typ}(@V_{GS}=-10V)$	< -48mΩ (Type:39 mΩ)

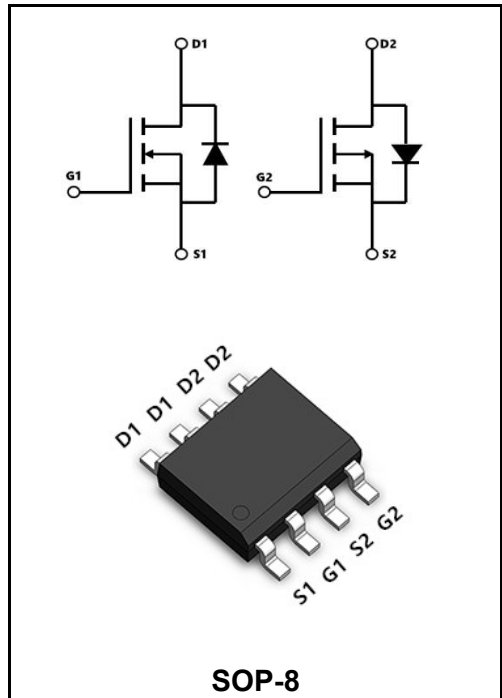

Application

- ◆ Battery protection
- ◆ Load switch
- ◆ Uninterruptible power supply

Product Specification Classification

Part Number	Package	Marking	Pack
YFW6G03S	SOP-8	YFW 6G03S XXXX	3000PCS/Tape

Maximum Ratings at Tc=25°C unless otherwise specified

Characteristics	Symbols	Value		Units
		N-Ch	P-Ch	
Drain-Source Voltage	V_{DS}	30	-30	V
Gate - Source Voltage	V_{GS}	±20	±20	V
Continuous Drain Current, $V_{GS} @ 10V^1 @ T_C=25^\circ C$	I_D	10	-7.6	A
Continuous Drain Current, $V_{GS} @ 10V^1 @ T_C=100^\circ C$	I_D	6	-5.9	A
Pulsed Drain Current ²	I_{DM}	20	-15	A
Single Pulse Avalanche Energy ³	E_{AS}	22	45	mJ
Avalanche Current	I_{AS}	21	-30	A
Total Power Dissipation ⁴ @T _C =25°C	P_D	2.0	2.0	W
Storage Temperature Range	T_{STG}	-55 to +150	-55 to +150	°C
Operating Junction Temperature Range	T_J	-55 to +150	-55 to +150	°C
Thermal Resistance Junction-Ambient ¹	R_{θJA}	-	62	°C/W
Thermal Resistance Junction-Case ¹	R_{θJC}	-	5	°C/W

N-Channel Electrical Characteristics (T_J=25 °C, unless otherwise noted)

Characteristics	Test Condition	Symbols	Min	Typ	Max	Units
Drain-Source Breakdown Voltage	V _{GS} =0V, I _D =250uA	BV_{DSS}	30	-	-	V
BVDSS Temperature Coefficient	Reference to 25 °C , I _D =1mA	ΔBV_{DSS}/ΔT_J	-	0.023	-	V/°C
Static Drain-Source On-Resistance ²	V _{GS} =10V, I _D =10A	R_{DS(ON)}	-	20	25	mΩ
	V _{GS} =4.5V, I _D =5A		-	30	38	mΩ
Gate Threshold Voltage	V _{DS} =V _{GS} , I _D =250uA	V_{GS(th)}	1.0	1.7	2.5	V
V _{GS(th)} Temperature Coefficient		ΔV_{GS(th)}	-	-5.2	-	mV/°C
Drain-Source Leakage Current	V _{DS} =24V, V _{GS} =0V T _J =25°C	I_{DSS}	-	-	1	uA
	V _{DS} =24V, V _{GS} =0V, T _J =55°C		-	-	5	
Gate-Source Leakage Current	V _{GS} =±20V, V _{DS} =0V	I_{GSS}	-	-	±100	nA
Forward Transconductance	V _{DS} = 5V, I _D = 10A	g_{fs}	-	16	-	S
Gate Resistance	V _{DS} =0V, V _{GS} =0V, f=1MHz	R_g	-	2.5	5	Ω
Total Gate Charge(4.5V)	V _{DS} =20V V _{GS} =4.5V I _D =10A	Q_g	-	7.2	-	nC
Gate-Source Charge		Q_{gs}	-	1.4	-	
Gate-Drain Charge		Q_{gd}	-	2.2	-	
Turn-on delay time	V _{DD} =15V V _{GS} =10V R _G = 3.3 I _D = 5A	t_{d(on)}	-	4.1	-	ns
Rise Time		T_r	-	9.8	-	
Turn-Off Delay Time		t_{d(OFF)}	-	15.5	-	
Fall Time		t_f	-	6.0	-	
Input Capacitance	V _{DS} =15V V _{GS} =0V f=1MHz	C_{iss}	-	572	-	pF
Output Capacitance		C_{oss}	-	81	-	
Reverse Transfer Capacitance		C_{rss}	-	65	-	
Continuous Source Current ^{1,5}	V _G =V _D =0V, Force Current	I_S	-	-	10	A
Pulsed Source Current ^{2,5}		I_{SM}	-	-	20	A
Diode Forward Voltage ²	V _{GS} =0V, I _S =1A, T _J =25°C	V_{SD}	-	-	1.2	V

Note :

- 1.The data tested by surface mounted on a 1 inch² FR-4 board with 2OZ copper.
- 2.The data tested by pulsed , pulse width ≦ 300us , duty cycle ≦ 2%
- 3.The EAS data shows Max. rating . The test condition is V_{DD}=25V,V_{GS}=10V,L=0.1mH,I_{AS}=21A
- 4 .The power dissipation is limited by 150°C junction temperature
- 5.The data is theoretically the same as I_D and I_{DM} , in real applications , should be limited by total power dissipation.

P-Channel Electrical Characteristics (T_J=25 °C, unless otherwise noted)

Characteristics	Test Condition	Symbols	Min	Typ	Max	Units
Drain-Source Breakdown Voltage	V _{GS} =0V, I _D =-250uA	BV_{DSS}	-30	-	-	V
BVDSS Temperature Coefficient	Reference to 25°C, I _D =-1mA	ΔBV_{DSS}/ΔT_J	-	-0.021	-	V/°C
Static Drain-Source On-Resistance ²	V _{GS} =-10V, I _D =-7A	R_{DS(ON)}	-	39	48	mΩ
	V _{GS} =-4.5V, I _D =-5A		-	53	58	mΩ
Gate -Threshold Voltage	V _{DS} =V _{GS} , I _D =-250uA	V_{GS(th)}	-1.0	-1.6	-2.5	V
V _{GS(th)} Temperature Coefficient		ΔV_{GS(th)}	-	-4.2	-	mV/°C
Drain-Source Leakage Current	V _{DS} =-24V, V _{GS} =0V T _J =25°C	I_{DSS}	-	-	-1	uA
	V _{DS} =-24V, V _{GS} =0V, T _J =55°C		-	-	-5	
Gate-Source Leakage Current	V _{GS} =±20V, V _{DS} =0V	I_{GSS}	-	-	±100	nA
Forward Transconductance	V _{DS} = -5V, I _D = -7A	g_{fs}	-	15	-	S
Gate Resistance	V _{DS} =0V, V _{GS} =0V, f=1MHz	R_g	-	15	30	Ω
Total Gate Charge(-4.5V)	V _{DS} =-20V V _{GS} =-4.5V I _D =-7A	Q_g	-	9.8	-	nC
Gate-Source Charge		Q_{gs}	-	2.2	-	
Gate-Drain Charge		Q_{gd}	-	3.4	-	
Turn-on delay time	V _{DD} =-15V V _{GS} =-10V R _G = 3.3 I _D =-5A	t_{d(on)}	-	16.4	-	ns
Rise Time		T_r	-	20.2	-	
Turn-Off Delay Time		t_{d(OFF)}	-	55	-	
Fall Time		t_f	-	10	-	
Input Capacitance	V _{DS} =-15V V _{GS} =0V f=1MHz	C_{iss}	-	930	-	pF
Output Capacitance		C_{oss}	-	148	-	
Reverse Transfer Capacitance		C_{rss}	-	115	-	
Continuous Source Current ^{1,5}	V _G =V _D =0V, Force Current	I_S	-	-	-7.6	A
Pulsed Source Current ^{2,5}		I_{SM}	-	-	-15	A
Diode Forward Voltage ²	V _{GS} =0V, I _S =-1A, T _J =25°C	V_{SD}	-	-	-1.2	V

Note :

- 1.The data tested by surface mounted on a 1 inch² FR-4 board with 2OZcopper.
- 2.The data tested by pulsed , pulse width ≅ 300us , duty cycle ≅ 2%
- 3.The EAS data sh.The power dissipation is limited by ows Max. rating
4. The test condition is 150°C junction temperature V_{DD}=-25V,V_{GS}=-10V,L=0.1mH,I_{AS}=-30A
- 5 .The data is theoretically the same as I_D and I_{DM} , in real applications , should be limited by total power dissipation.

Ratings and Characteristic Curves

N-Channel Typical Characteristics

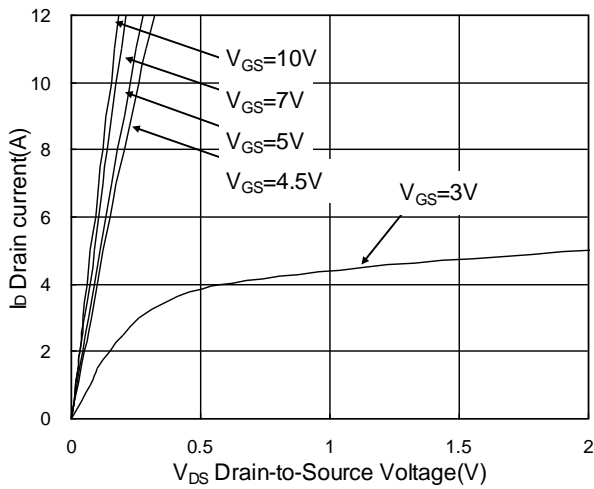

Fig.1 Typical Output Characteristics

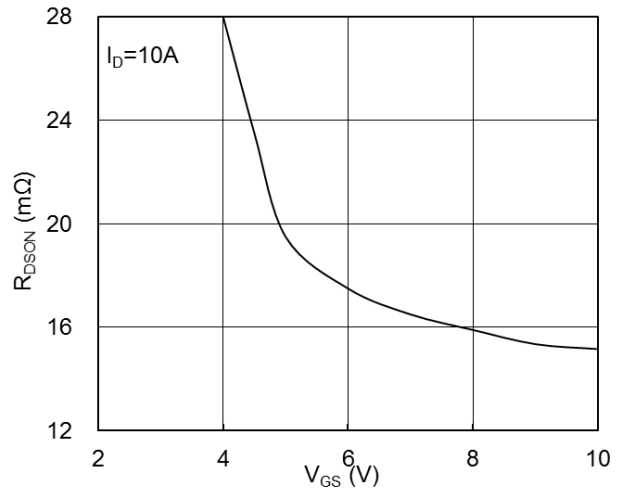

Fig.2 On-Resistance vs Gate-Source Voltage

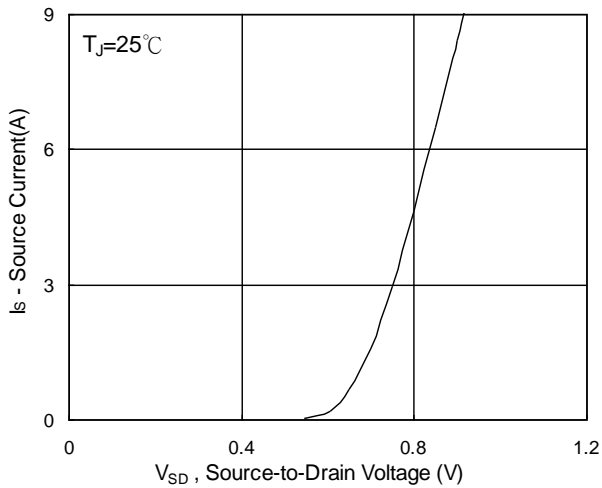

Fig.3 Forward Characteristics of Reverse

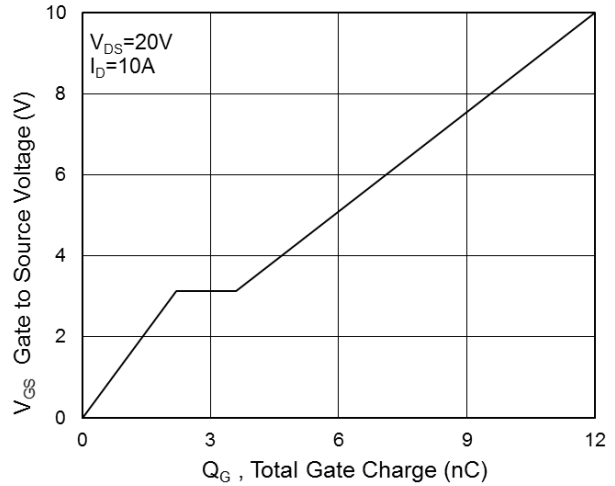

Fig.4 Gate-Charge characteristics

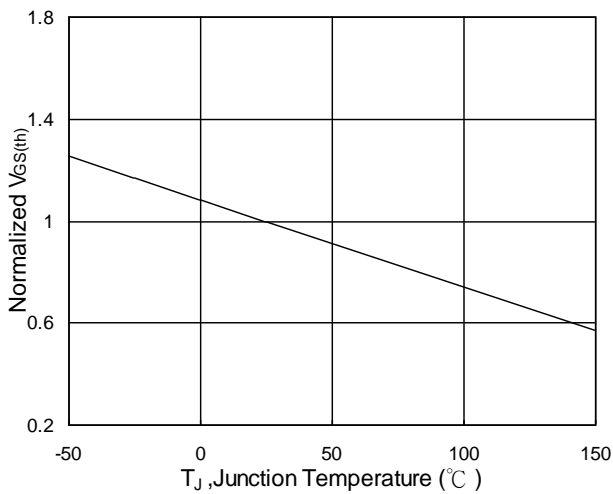

Fig.5 Normalized $V_{GS(th)}$ vs T_J

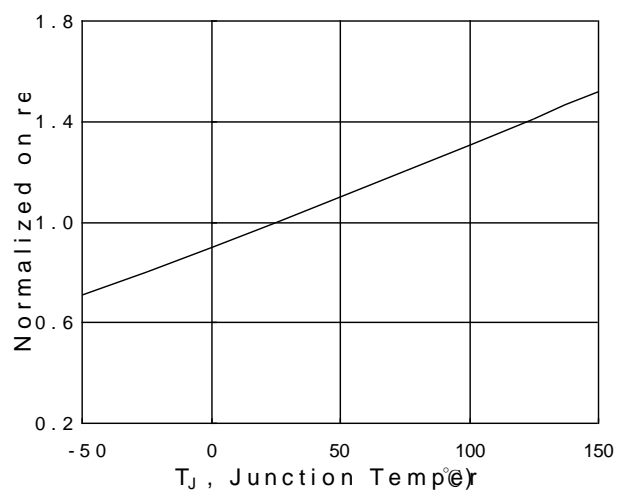

Fig.6 Normalized $R_{DS(on)}$ vs T_J

Ratings and Characteristic Curves

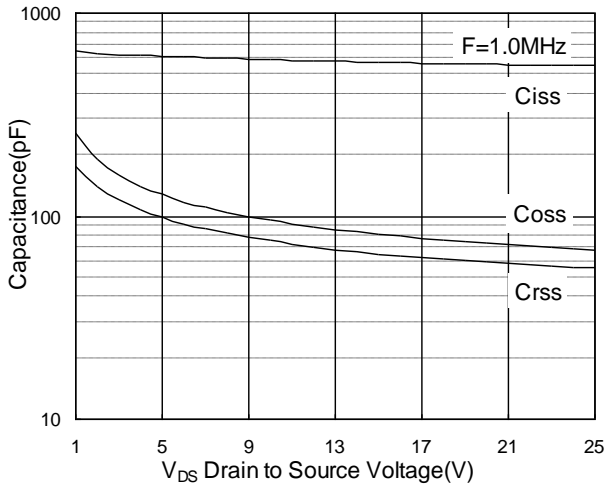

Fig.7 Capacitance

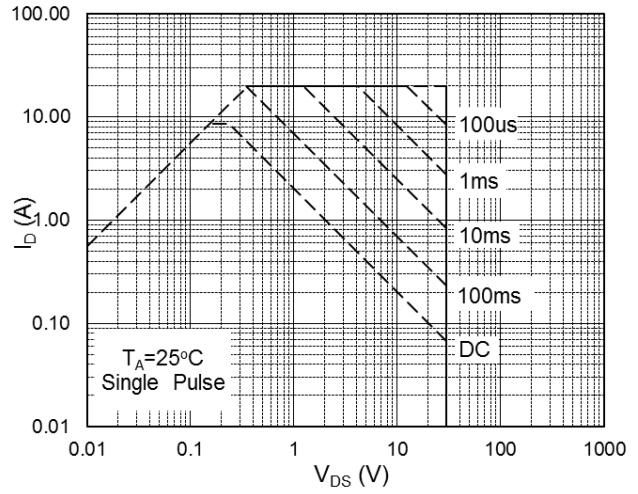

Fig.8 Safe Operating Area

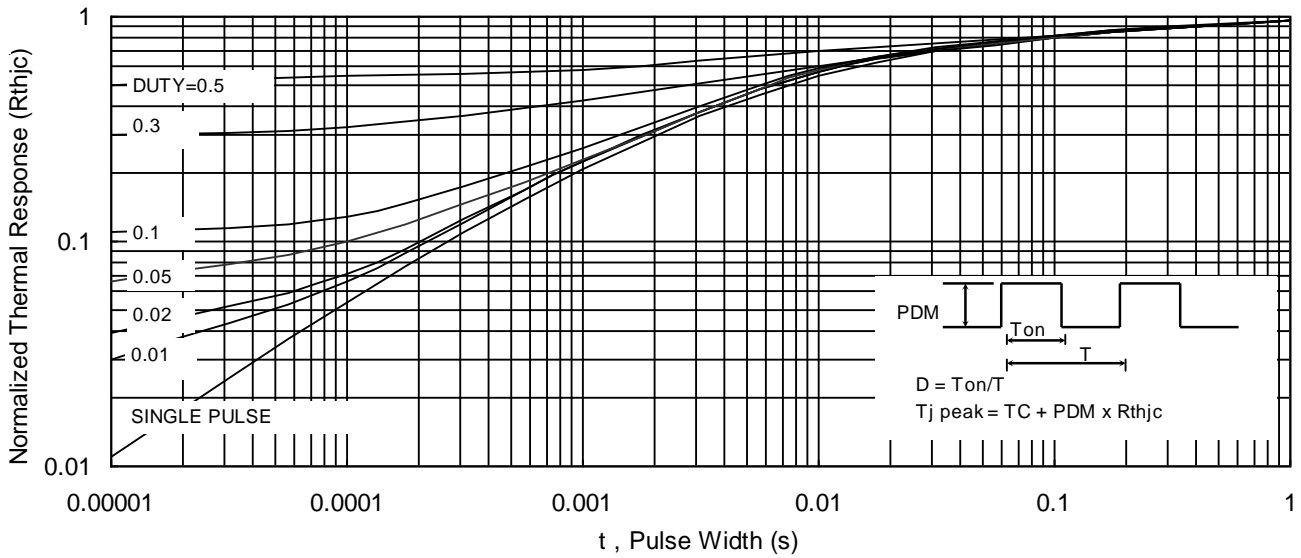

Fig.9 Normalized Maximum Transient Thermal Impedance

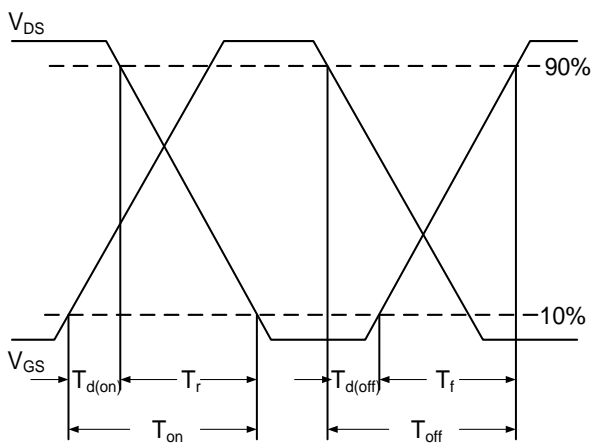

Fig.10 Switching Time Waveform

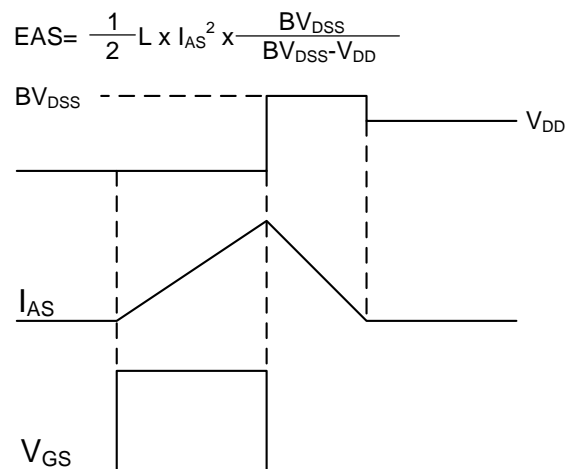

Fig.11 Unclamped Inductive Waveform

Ratings and Characteristic Curves

P-Channel Typical Characteristics

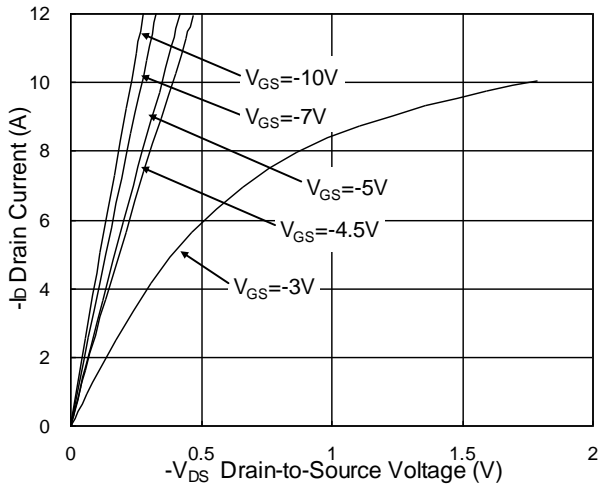

Fig.1 Typical Output Characteristics

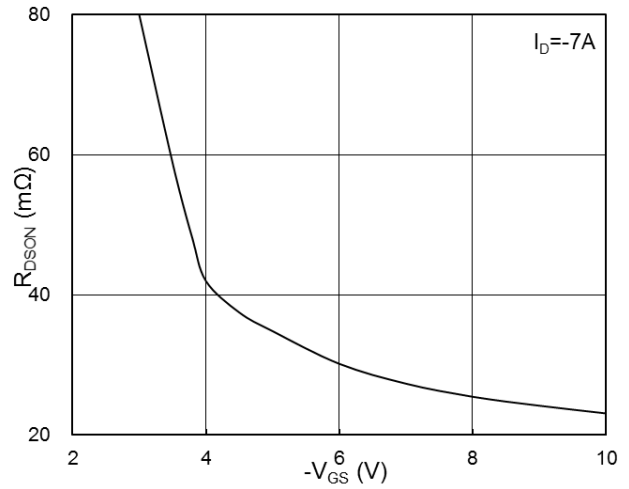

Fig.2 On-Resistance vs Gate-Source Voltage

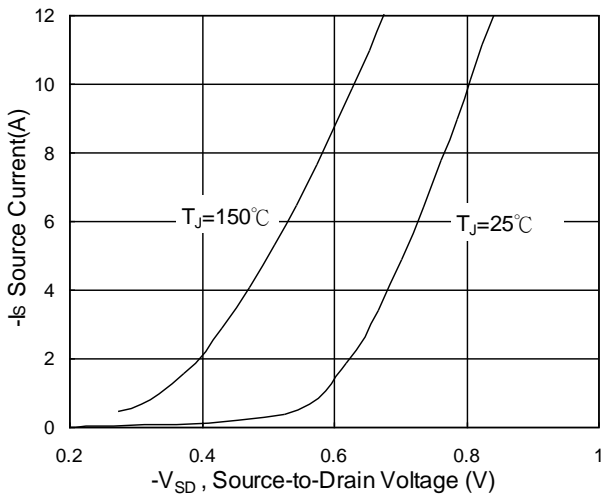

Fig.3 Forward Characteristics of Reverse

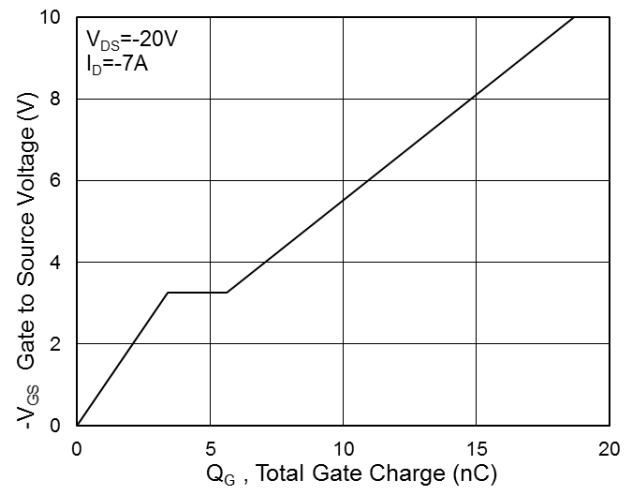

Fig.4 Gate-Charge Characteristics

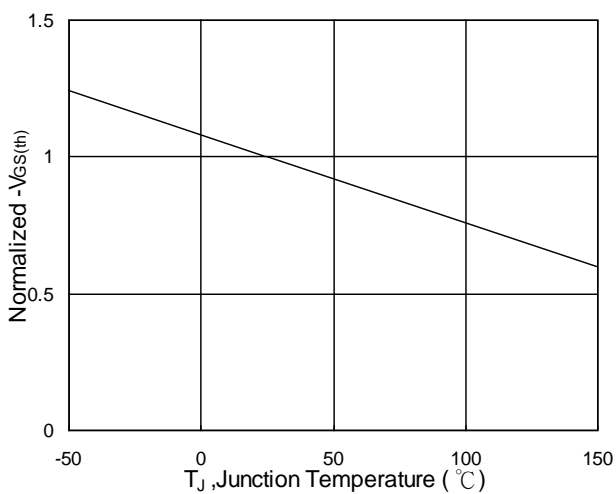

Fig.5 Normalized $V_{GS(th)}$ vs T_J

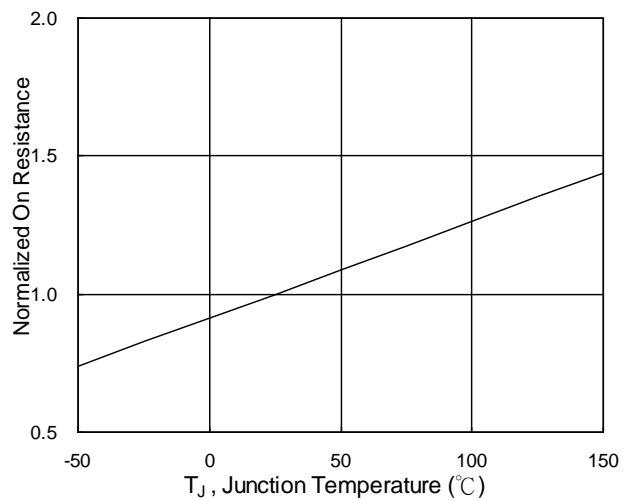

Fig.6 Normalized $R_{DS(on)}$ vs T_J

Ratings and Characteristic Curves

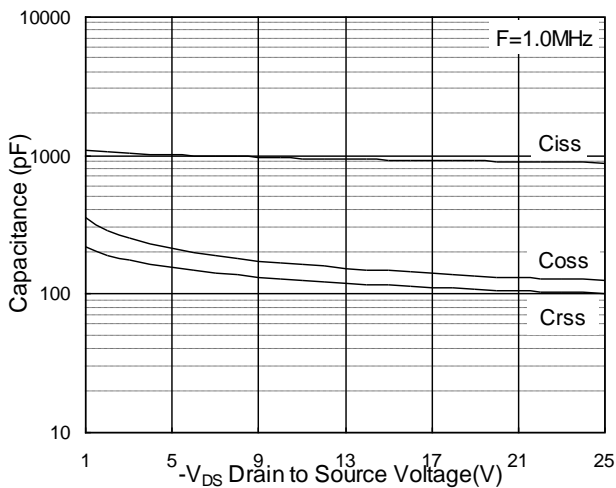

Fig.7 Capacitance

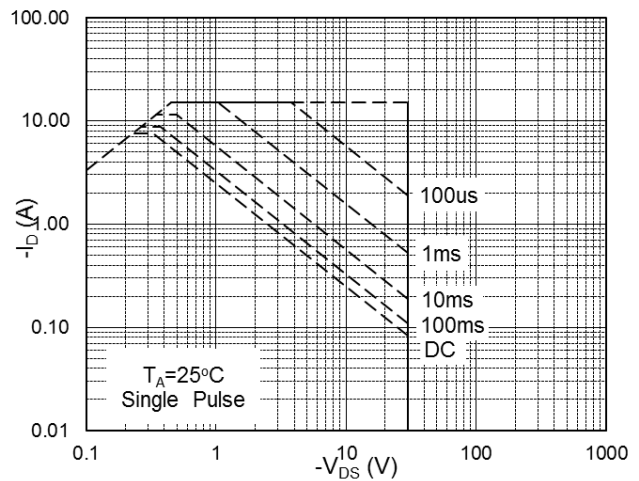

Fig.8 Safe Operating Area

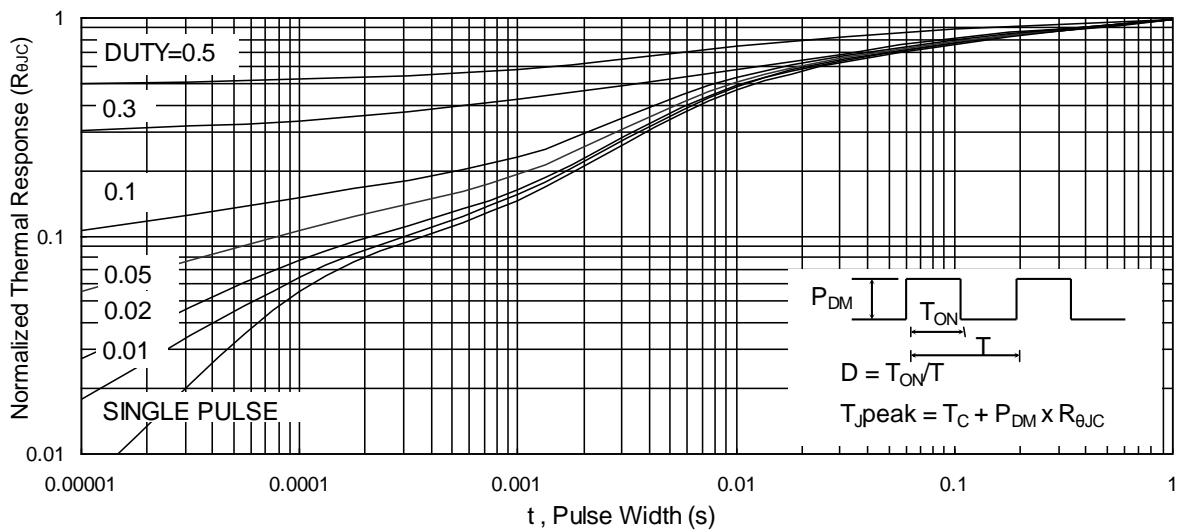

Fig.9 Normalized Maximum Transient Thermal Impedance

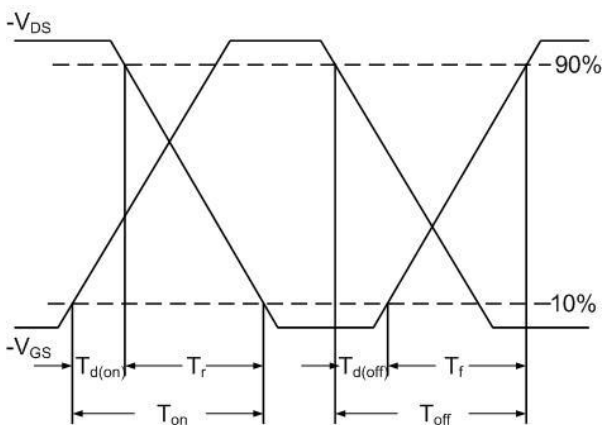

Fig.10 Switching Time Waveform

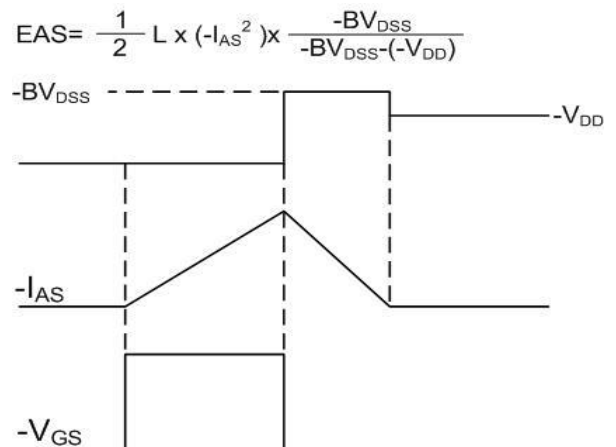
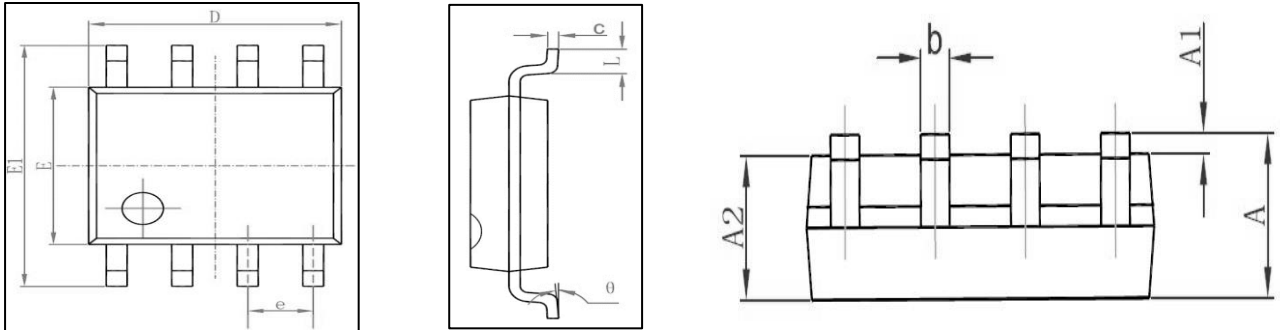
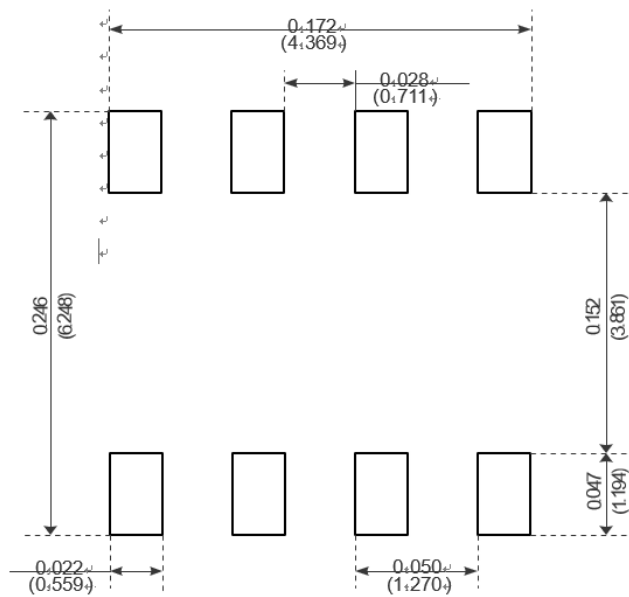

Fig.11 Unclamped Inductive Waveform

SOP-8



Symbol	Dimensions In Millimeters		Dimensions In Inches	
	Min	Max	Min	Max
A	1.350	1.750	0.053	0.069
A1	0.100	0.250	0.004	0.010
A2	1.350	1.550	0.053	0.061
b	0.330	0.510	0.013	0.020
c	0.170	0.250	0.006	0.010
D	4.700	5.100	0.185	0.200
E	3.800	4.000	0.150	0.157
E1	5.800	6.200	0.228	0.244
e	1.270 (BSC)		0.050 (BSC)	
L	0.400	1.270	0.016	0.050
θ	0°	8°	0°	8°



Recommended Minimum Pads

X-ON Electronics

Largest Supplier of Electrical and Electronic Components

Click to view similar products for [MOSFET](#) category:

Click to view products by [YFW Electronics](#) manufacturer:

Other Similar products are found below :

[IRFD120](#) [JANTX2N5237](#) [2SK2267\(Q\)](#) [BUK455-60A/B](#) [TK100A10N1,S4X\(S](#) [MIC4420CM-TR](#) [VN1206L](#) [NDP4060](#) [SI4482DY](#)
[IRS2092STRPBF-EL](#) [IPS70R2K0CEAKMA1](#) [TK31J60W5,S1VQ\(O](#) [TK31J60W,S1VQ\(O](#) [TK16J60W,S1VQ\(O](#) [2SK2614\(TE16L1,Q\)](#)
[DMN1017UCP3-7](#) [EFC2J004NUZTDG](#) [P85W28HP2F-7071](#) [DMN1053UCP4-7](#) [NTE2384](#) [DMC2700UDMQ-7](#) [DMN2080UCB4-7](#)
[DMN61D9UWQ-13](#) [US6M2GTR](#) [DMN31D5UDJ-7](#) [DMP22D4UFO-7B](#) [IPS60R3K4CEAKMA1](#) [DMN1006UCA6-7](#) [DMN16M9UCA6-7](#)
[STF5N65M6](#) [IRF40H233XTMA1](#) [STU5N65M6](#) [DMN6022SSD-13](#) [DMN13M9UCA6-7](#) [DMTH10H4M6SPS-13](#) [IPS60R360PFD7SAKMA1](#)
[DMN2990UFB-7B](#) [SSM3K35CT,L3F](#) [IPLK60R1K0PFD7ATMA1](#) [2N7002W-G](#) [MCAC30N06Y-TP](#) [IPWS65R035CFD7AXKSA1](#)
[MCQ7328-TP](#) [SSM3J143TU,LXHF](#) [PJMF280N65E1_T0_00201](#) [PJMF380N65E1_T0_00201](#) [PJMF280N60E1_T0_00201](#)
[PJMF600N65E1_T0_00201](#) [PJMF900N65E1_T0_00201](#) [PJMF900N60E1_T0_00201](#)