

P6SMB Transient Voltage Suppressor Diode Series

General Information

The P6SMB series is designed to protect voltage sensitive components from high voltage, high energy transients. They have excellent clamping capability, high surge capability, low zener impedance and fast response time. The P6SMB series is supplied in YINT Semiconductor's exclusive, cost-effective, highly reliable and is ideally suited for use in communication systems, automotive, numerical controls, process controls, medical equipment, business machines, power supplies and many other industrial/consumer Applications.



Molded plastic
glass passivated junction.

Features

- Case: DO-214AA/SMB
- For surface mounted applications in order to optimize board space.
- Polarity: Color band denoted positive end (cathode) except Bidirectional.
- Typical failure mode is short from over-specified voltage or current
- High Temperature soldering: 260°C/10 seconds at terminals.
- Terminal: Solder plated, solderable per MIL-STD-750, Method 2026.

Applications

TVS devices are ideal for the protection of I/O Interfaces, V_{CC} bus and other vulnerable circuits used in Telecom, Computer, Industrial and Consumer electronic applications.

Electrical Characteristics (@ $T_A = 25^\circ\text{C}$ Unless Otherwise Noted)

Parameter	Symbol	Value	Unit
Minimum Peak Pulse Power Dissipation ($T = 1 \text{ ms}$) (note1 note 2)	P_{PK}	600	Watts
Peak Forward Surge Current 8.3 ms Single Half Sine Wave Superimposed on Rated Load (JEDEC Method) (Note 3)	I_{FSM}	100	Amps
Steady State Power Dissipation @ $T_L = 75^\circ\text{C}$	$P_{M(AV)}$	5.0	Watts
Maximum Instantaneous Forward Voltage @ $I_{PP} = 50 \text{ A}$ (For Unidirectional Units Only)(note4 note 5)	V_F	3.5/5	Volts
Operating Temperature Range	T_J	-55 to +150	$^\circ\text{C}$
Storage Temperature Range	T_{STG}	-55 to +175	$^\circ\text{C}$

NOTES:

1. Non-repetitive current pulse, per Pulse Waveform graph and above $T_A = 25^\circ\text{C}$ per Pulse Derating Curve.
2. Thermal Resistance Junction to Lead.
3. 8.3 ms Single Half-Sine Wave duty cycle = 4 pulses maximum per minute (unidirectional units only).
4. Single Phase, Half Wave, 60 Hz, resistive or inductive load. For capacitive load, derate current by 20 %.
5. $V_F < 3.5\text{V}$ for $V_{BR} < 200\text{V}$ and $V_F < 5.0\text{V}$ for $V_{BR} > 201\text{V}$.

Electrical Characteristics ($T_A = 25\text{ }^\circ\text{C}$ unless otherwise noted)

Part Number (Bi)	Part Number (Uni)	MARKING		Reverse Stand off Voltage V_R (Volts)	Breakdown Voltage V_{BR} (Volts)@ I_T		Test Current I_T (mA)	Maximum Reverse Leakage I_R @ V_R (μ A)	Maximum Peak Pulse Current I_{pp} (A)	Maximum Clamping Voltage V_C @ I_{pp} (V)
		BI	UNI		Min .V	Max .V				
P6SMB6.8CA	P6SMB6.8A	6V8C	6V8A	5.8	6.45	7.14	10	800	58.1	10.5
P6SMB7.5CA	P6SMB7.5A	7V5C	7V5A	6.4	7.13	7.88	10	500	54.0	11.3
P6SMB 8.2CA	P6SMB8.2A	8V2C	8V2A	7.02	7.79	8.61	10	200	50.4	12.1
P6SMB 9.1CA	P6SMB9.1A	9V1C	9V1A	7.78	8.65	9.55	10	50	45.5	13.4
P6SMB10CA	P6SMB10A	10C	10A	8.55	9.50	10.50	10	10	42.1	14.5
P6SMB11CA	P6SMB11A	11C	11A	9.40	10.50	11.60	1	5	39.1	15.6
P6SMB12CA	P6SMB12A	12C	12A	10.20	11.40	12.60	1	5	36.5	16.7
P6SMB13CA	P6SMB13 A	13C	13A	11.10	12.40	13.70	1	1	33.5	18.2
P6SMB15CA	P6SMB15A	15C	15A	12.80	14.30	15.80	1	1	28.8	21.2
P6SMB16CA	P6SMB16A	16C	16A	13.60	15.20	16.80	1	1	27.1	22.5
P6SMB18CA	P6SMB18A	18C	18A	15.30	17.10	18.90	1	1	24.2	25.2
P6SMB20CA	P6SMB20A	20C	20A	17.10	19.00	21.00	1	1	22.0	27.7
P6SMB22CA	P6SMB22A	22C	22A	18.80	20.90	23.10	1	1	19.9	30.6
P6SMB24CA	P6SMB24A	24C	24A	20.50	22.80	25.20	1	1	18.4	33.2
P6SMB27CA	P6SMB27A	27C	27A	23.10	25.70	28.40	1	1	16.3	37.5
P6SMB30CA	P6SMB30A	30C	30A	25.60	28.50	31.50	1	1	14.7	41.4
P6SMB33CA	P6SMB33A	33C	33A	28.20	31.40	34.70	1	1	13.3	45.7
P6SMB36CA	P6SMB36A	36C	36A	30.80	34.20	37.80	1	1	12.2	49.9
P6SMB39CA	P6SMB39A	39C	39A	33.30	37.10	41.00	1	1	11.3	53.9
P6SMB43CA	P6SMB43A	43C	43A	36.80	40.90	45.20	1	1	10.3	59.3
P6SMB47CA	P6SMB47A	47C	47A	40.20	44.70	49.40	1	1	9.4	64.8
P6SMB51CA	P6SMB51A	51C	51A	43.60	48.50	53.60	1	1	8.7	70.1
P6SMB56CA	P6SMB56A	56C	56A	47.80	53.20	58.80	1	1	7.9	77.0
P6SMB62CA	P6SMB62A	62C	62A	53.00	58.90	65.10	1	1	7.2	85.0
P6SMB68CA	P6SMB68A	68C	68A	58.10	64.60	71.40	1	1	6.6	92.0
P6SMB75CA	P6SMB75A	75C	75A	64.10	71.30	78.00	1	1	5.9	103.0
P6SMB82CA	P6SMB82A	82C	82A	70.10	77.90	86.10	1	1	5.4	113.0
P6SMB91CA	P6SMB91A	91C	91A	77.80	86.50	95.50	1	1	4.9	125.0
P6SMB100CA	P6SMB100A	100C	100A	85.50	95.0	105.0	1	1	4.5	137.0
P6SMB110CA	P6SMB110A	110C	110A	94.00	105.0	116.0	1	1	4.0	152.0
P6SMB120CA	P6SMB120A	120C	120A	102.0	114.0	126.0	1	1	3.7	165.0
P6SMB130CA	P6SMB130A	130C	130A	111.0	124.0	137.0	1	1	3.4	179.0
P6SMB150CA	P6SMB150A	150C	150A	128.0	143.0	158.0	1	1	2.9	207.0

Part Number (Bi)	Part Number (Uni)	MARKING		Reverse Stand off Voltage V_R (Volts)	Breakdown Voltage V_{BR} (Volts)@ I_T		Test Current I_T (mA)	Maximum Reverse Leakage $I_R@V_R$ (μ A)	Maximum Peak Pulse Current I_{pp} (A)	Maximum Clamping Voltage $V_C@I_{pp}$ (V)
		BI	UNI		Min .V	Max .V				
P6SMB160CA	P6SMB160A	160C	160A	136.0	152.0	168.0	1	1	2.8	219.0
P6SMB170CA	P6SMB170A	170C	170A	145.0	162.0	179.0	1	1	2.6	234.0
P6SMB180CA	P6SMB180A	180C	180A	154.0	171.0	189.00	1	1	2.5	246.0
P6SMB200CA	P6SMB200A	200C	200A	171.0	190.0	210.0	1	1	2.2	274.0

I-V Curve Characteristics

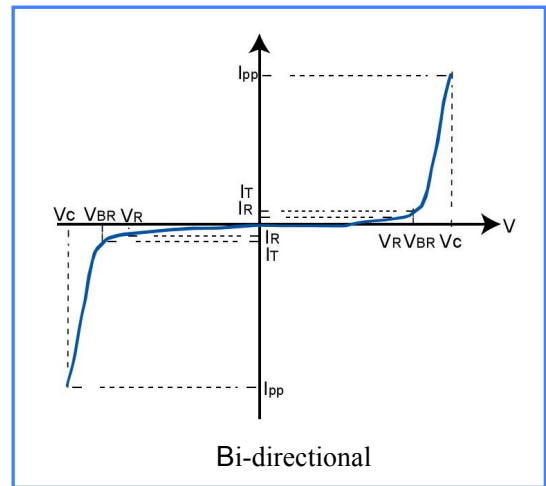
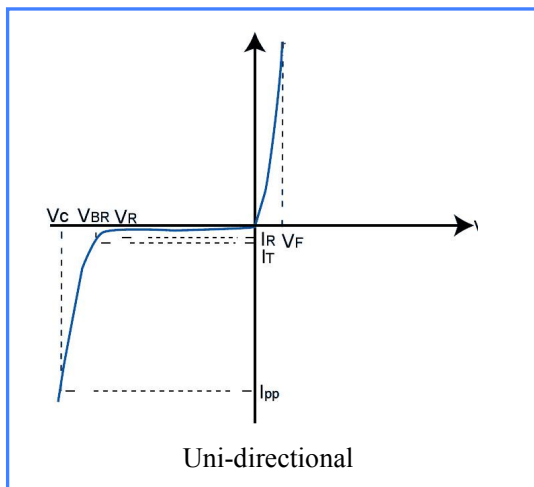

Symbol	Parameter
I_{PP}	Maximum Reverse Peak Pulse Current
V_C	Clamping Voltage @ I_{PP}
V_{RWM}	Working Peak Reverse Voltage
I_R	Maximum Reverse Leakage Current @ V_{RWM}
V_{BR}	Breakdown Voltage @ I_T
I_T	Test Current

Rating & Characteristic Curves

Figure 1- Pulse Derating Curve

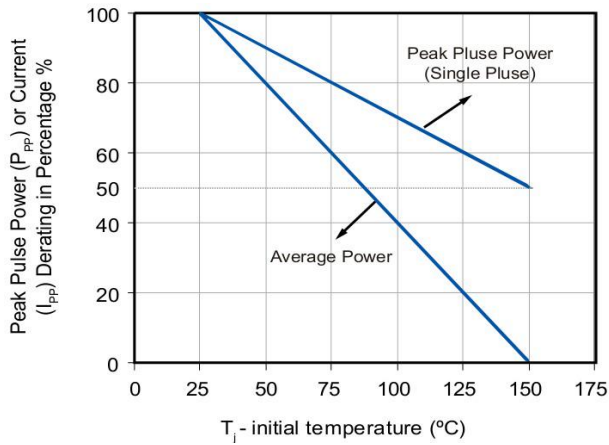

Figure 2- Maximum Non-Repetitive Surge Current

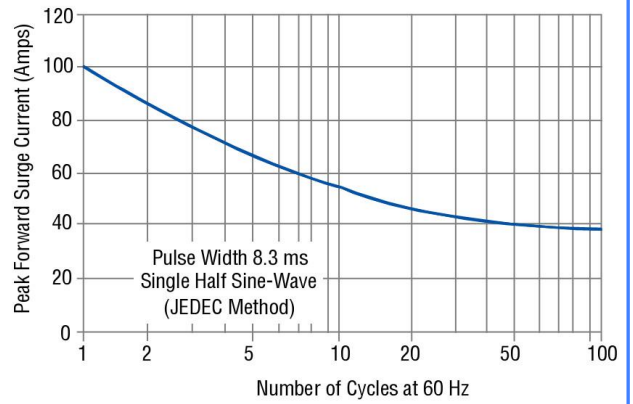

Figure 3- Typical Junction Capacitance

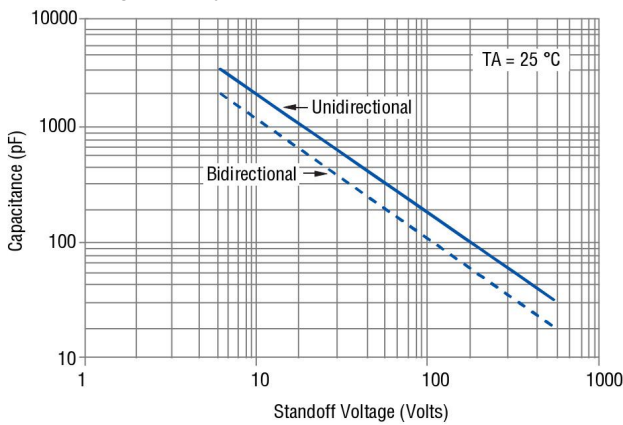

Figure 4- Pulse Waveform

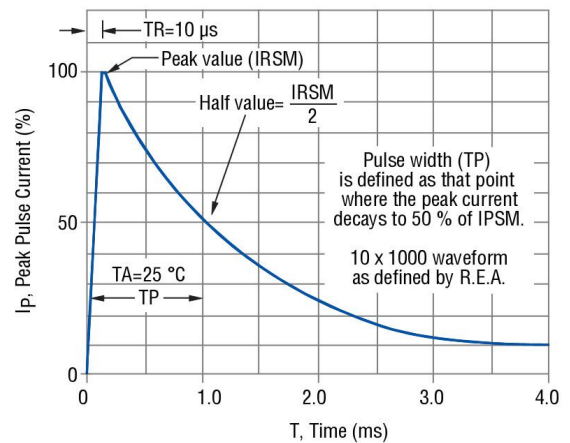

Figure 5- Steady State Power Derating Curve

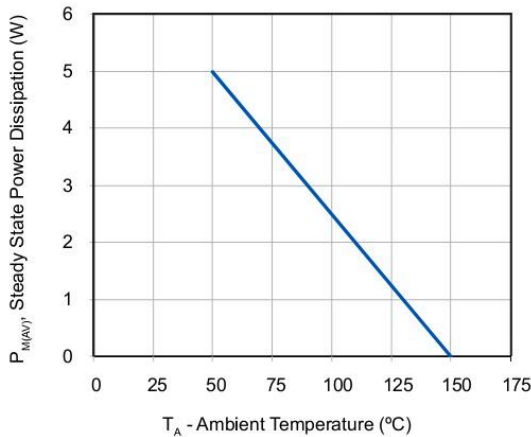
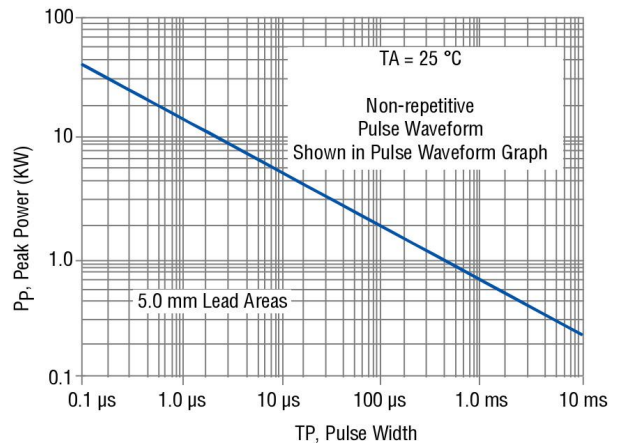
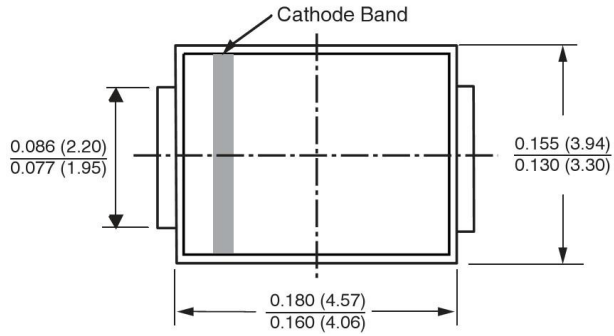

Figure 6- Pulse Rating Curve



PACKAGE OUTLINE DIMENSIONS in inches (millimeters)

DO-214AA (SMB)



Mounting Pad Layout

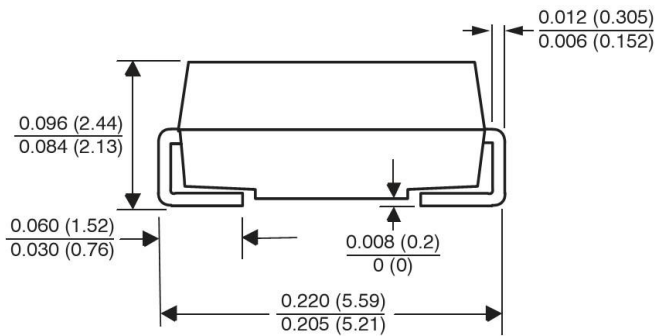
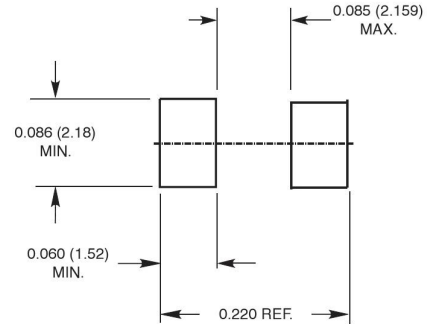

Disclaimer

Specifications are subject to change without notice.

The device characteristics and parameters in this data sheet can and do vary in different applications and actual device performance may vary over time.

Users should verify actual device performance in their specific applications.

X-ON Electronics

Largest Supplier of Electrical and Electronic Components

Click to view similar products for [ESD Suppressors / TVS Diodes](#) category:

Click to view products by [Yint](#) manufacturer:

Other Similar products are found below :

[NTE4902](#) [P4SMAJ15A](#) [P4SMAJ26A](#) [SMAJ400CA-TP](#) [TGL34-47CA](#) [ESDAULC45-1BF4](#) [SM1605E3/TR13](#) [SMF20A-TP](#) [P4SMAJ12A](#)
[CPDUR24V-HF](#) [CPDQC5V0USP-HF](#) [CPDQC5V0-HF](#) [MPLAD30KP45CAE3](#) [MMBZ27VCLQ-7-F](#) [MMAD1108/TR13](#) [MPLAD30KP24A](#)
[ACPDQC5V0R-HF](#) [DFLT170A-7](#) [NTE4900](#) [NTE4926](#) [NTE4938](#) [SMF22A-TP](#) [SMF12A-TP](#) [SLVU2.8-TP](#) [SMLJ6.5CA-TP](#) [SMAJ6.5CA-](#)
[TP](#) [MMAD1108E3/TR13](#) [D5V0M1U2LP3-7](#) [SMAJ400A-TP](#) [AOZ8811DT-03](#) [AOZ8831DI-05](#) [AOZ8831DT-03](#) [SMAJ188CA](#) [3SMC33CA](#)
[BK](#) [CPDQC3V3C-HF](#) [CPDQC12VE-HF](#) [MPLAD30KP170CA](#) [82357120100](#) [5.0SMLJ15CA-TP](#) [5KP18A-TP](#) [P6KE8.2A-TP](#)
[MPLAD30KP43CAE3](#) [SMAJ43A-TP](#) [D5V0F6U8LP33-7](#) [TVS5501V10MUT5G](#) [5.0SMLJ24CA-TP](#) [SMAJ110CA-TP](#) [MPLAD15KP75CAE3](#)
[MMAD1103e3/TR13](#) [DFLT40AQ-7](#)