

PRODUCTS CATALOG

电路保护元器件制造商
解决方案服务商

MANUFACTURER OF CIRCUIT PROTECTION COMPONENTS
PROVIDER OF SOLUTION

选音特就是选品质

CHOOSING YINT IS TO CHOOSE QUALITY

公司总部（华东地区）

中国上海市松江区广富林东路199号启迪漕河泾（中山）科技园水木园9幢4层
Floor 4, No.9 Building, Tus-Caohejing (Zhongshan) Science Park No.199, East Guangfulin Road,
Songjiang District, Shanghai, China
Tel: +86-21-22817629
Fax: +86-21-67689607
Email: sales@yint.com.cn

音特技术研究院

中国上海市松江工业区车墩镇泖亭路188弄财富兴园·国际企业园35号101栋
No.101 Building, No.35 Fortune Zone International Office Park, No.188 Lane, Maoting Road,
Chedun Town, Songjiang District, Shanghai, China

工厂地址

安徽省芜湖市湾沓区新芜经济技术开发区中兴五路领特工业园1栋
No.1 Building, Leader Industrial Park, Zhongxing No.5 Road, Xinwu Economic Development
Zone, Wanzhi District, Wuhu, Anhui Province, China
广东省汕头市龙湖区浦江路电子工业园6栋
No.6 Building, Electronic Industrial Park, Pujiang Road, Longhu District, Shantou, Guangdong
Province, China

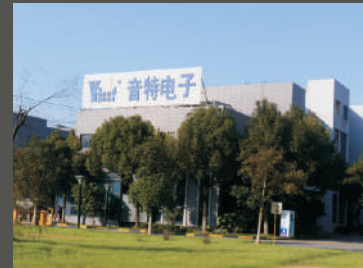

华南地区

深圳市宝安区28区大宝路金富来大厦B座3层
3/F, Building B, Jin Fulai Plaza, Dabao Road, No.28 Zone,
Baoan District, Shenzhen
Tel: +86-755-86655040
Fax: +86-755-86655115
Email: sales@yint.com.cn

西南地区

重庆市南岸区茶园新区同景路5号同景国际广场S1组团A2栋23-1
Room 23-1, Building A2, S1 Zone, Tongjing International Plaza,
No.5 Tongjing Road, Chayuan Area, Nanan District, Chongqing
Tel: +86-23-62948995
Fax: +86-23-62937530
Email: cq@yint.com.cn

印度地区

No.11-12 Aradhana, Classic Paradise Layout, Begur,
Bangalore 560068, Karnataka, India
Tel: +00919945512488 Email: india@yint.com.cn

华北地区

北京市昌平区黄平路19号龙旗广场D座10层1001
Room 101, 10/F, Building D, No.19 Longqqi Plaza, Huangping Road,
Changping District, Beijing
Tel: +86-10-82616984
Fax: +86-10-82616984-621
Email: bj@yint.com.cn

中部地区

河南省郑州市高新区科学大道盛龙友谊公园B座15楼
15F, Tower B, Shenglong Youyi Park, Science Avenue, High-Tech
Zone, Zhengzhou City, Henan
Tel: 0371-66855917-803
Fax: 0371-66859535
Email: saleshn@yint.com.cn

本手册最终解释权归音特电子。手册内容如有变更恕不另行通知。
The right of final interpretation of this catalog belongs to YINT ELECTRONICS.
Catalog is subject to change without notice.

YINT ELECTRONICS 音特电子



www.yint.com.cn
(中文网站)



www.yint-electronic.com
(English Website)



yint.en.alibaba.com

ABOUT US 关于我们



音特电子，行业领先的电路保护元件制造商和解决方案服务商，高新技术企业。公司位于上海长三角G60科创走廊。业务涵盖产品研发、生产制造、销售、服务。

公司主要产品和服务包括：TVS瞬态抑制二极管、ESD静电保护元件、PPTC自恢复保险丝、TSS半导体放电管、GDT气体放电管、SBR肖特基二极管、MOV压敏电阻、NTC热敏电阻、RD整流二极管、HALL霍尔传感器、MOSFET场效应管、个性化的电路保护设计、专业化的客户解决方案等。产品销往中国内地、台湾、香港以及东南亚、欧洲、北美数十个国家和地区。

公司于2007年以零缺陷通过了ISO9001质量管理体系认证。系列产品完成UL、VDE、CSA等国际标准论证。产品原材料均已通过RoHS检测。

音特电子立足上海，服务全国，放眼全球。公司以振兴民族工业为自己的使命，以“十年磨一剑”的专注和笃行，聚焦关键核心技术，长周期、高投入支持原创技术的研发，并与上海工程技术大学共同设立了产学研合作教育基地。

公司拥有数十项自主知识产权和专利技术，成立了音特技术研究院以推动新技术新产品的开发。公司凭借创新的技术和先进的项目管理经验，为客户提供一流的产品和服务。

公司以“一流的匠心，打造一流的产品和服务”为宗旨，以“改善、创新、节约、双赢”为经营理念，秉承“一丝不苟、精益求精”的企业精神，肩负强烈的责任和使命，奋发有为、努力进取为中国半导体产业在全球半导体领域中实现突破和崛起而不断前行。

Yint Electronics, Leading manufacturer of circuit protection components and solution provider, High-tech enterprises. Company is located in Shanghai Yangtze River Delta G60 Science & Technology Innovation Valley. Business covers R&D, manufacturing, sales and services.

Company's main products and services include: Transient Voltage Suppressor(TVS), Polymetric Positive Temperature Coefficient(PPTC), Electrostatic Discharge Device(ESD), Thyristor Surge Suppressor(TSS), Gas Discharge Tube(GDT), Metal Oxide Varistor(MOV), Schottky Barrier Rectifier(SBR), Negative Temperature Coefficient(NTC), Rectifier Diode(RD), Hall Sensor, MOSFET, professional circuit protection design and solution, etc. Products sold to the mainland of China, Taiwan, Hong Kong and Southeast Asia, Europe, North America dozens of countries and regions.

Company passed ISO9001 Quality Management System Certification with zero defect in 2007. Some products completed UL、VDE、CSA and other international standards. All raw materials have passed RoHS inspection.

Yint Electronics based in Shanghai, serving the whole country, looking around the world. Company takes the revitalization of national industry as its mission, with the focus and commitment of "ten years of grinding a sword", focusing on key core technologies, long period, high investment to support original technology development, and setting up a cooperative education base with Shanghai University of Engineering and Technology.

Company has dozens of independent intellectual property rights and patents, set up Yint Academy of Technology to promote the development of new technologies and new products. With innovative technology and advanced project management experience, Company provides customers with first-class products and services.

Company takes "the first-class craftsman heart, creates the first-class product and the service" as the aim, takes "improvement, innovation, saving, win-win" as the management idea, adheres to enterprise spirit of "meticulousness, strives for perfection", with the strong sense of responsibility and mission, diligently strives for the Chinese semiconductor industry to achieve breakthrough and rise in the global semiconductor field.

YINT ELECTRONICS 音特电子



www.yint.com.cn
(中文网站)



www.yint-electronic.com
(English Website)



yint.en.alibaba.com

ABOUT US 关于我们



音特电子，行业领先的电路保护元件制造商和解决方案服务商，高新技术企业。公司位于上海长三角G60科创走廊。业务涵盖产品研发、生产制造、销售、服务。

公司主要产品和服务包括：TVS瞬态抑制二极管、ESD静电保护元件、PPTC自恢复保险丝、TSS半导体放电管、GDT气体放电管、SBR肖特基二极管、MOV压敏电阻、NTC热敏电阻、RD整流二极管、HALL霍尔传感器、MOSFET场效应管、个性化的电路保护设计、专业化的客户解决方案等。产品销往中国内地、台湾、香港以及东南亚、欧洲、北美数十个国家和地区。

公司于2007年以零缺陷通过了ISO9001质量管理体系认证。系列产品完成UL、VDE、CSA等国际标准论证。产品原材料均已通过RoHS检测。

音特电子立足上海，服务全国，放眼全球。公司以振兴民族工业为自己的使命，以“十年磨一剑”的专注和笃行，聚焦关键核心技术，长周期、高投入支持原创技术的研发，并与上海工程技术大学共同设立了产学研合作教育基地。

公司拥有数十项自主知识产权和专利技术，成立了音特技术研究院以推动新技术新产品的开发。公司凭借创新的技术和先进的项目管理经验，为客户提供一流的产品和服务。

公司以“一流的匠心，打造一流的产品和服务”为宗旨，以“改善、创新、节约、双赢”为经营理念，秉承“一丝不苟、精益求精”的企业精神，肩负强烈的责任和使命，奋发有为、努力进取为中国半导体产业在全球半导体领域中实现突破和崛起而不断前行。

Yint Electronics, Leading manufacturer of circuit protection components and solution provider, High-tech enterprises. Company is located in Shanghai Yangtze River Delta G60 Science & Technology Innovation Valley. Business covers R&D, manufacturing, sales and services.

Company's main products and services include: Transient Voltage Suppressor(TVS), Polymetric Positive Temperature Coefficient(PPTC), Electrostatic Discharge Device(ESD), Thyristor Surge Suppressor(TSS), Gas Discharge Tube(GDT), Metal Oxide Varistor(MOV), Schottky Barrier Rectifier(SBR), Negative Temperature Coefficient(NTC), Rectifier Diode(RD), Hall Sensor, MOSFET, professional circuit protection design and solution, etc. Products sold to the mainland of China, Taiwan, Hong Kong and Southeast Asia, Europe, North America dozens of countries and regions.

Company passed ISO9001 Quality Management System Certification with zero defect in 2007. Some products completed UL、VDE、CSA and other international standards. All raw materials have passed RoHS inspection.

Yint Electronics based in Shanghai, serving the whole country, looking around the world. Company takes the revitalization of national industry as its mission, with the focus and commitment of "ten years of grinding a sword", focusing on key core technologies, long period, high investment to support original technology development, and setting up a cooperative education base with Shanghai University of Engineering and Technology.

Company has dozens of independent intellectual property rights and patents, set up Yint Academy of Technology to promote the development of new technologies and new products. With innovative technology and advanced project management experience, Company provides customers with first-class products and services.

Company takes "the first-class craftsman heart, creates the first-class product and the service" as the aim, takes "improvement, innovation, saving, win-win" as the management idea, adheres to enterprise spirit of "meticulousness, strives for perfection", with the strong sense of responsibility and mission, diligently strives for the Chinese semiconductor industry to achieve breakthrough and rise in the global semiconductor field.

OUR ADVANTAGES

我们的优势



质量稳定

测试手段完备，产品符合相关国际国内行业标准。

High Quality

Complete testing methods, products meet relevant international and domestic industry standards.



服务周到

可提供技术支持、方案设计、测试评估增值服务

Good Service

Professional technical support, project design, testing and evaluation services.



交货准时

配置先进PMC系统，强大的常规器件备库能力。

Fast Delivery

Advanced PMC system and effective warehouse management system.



性价比高

自动化流水线，规模化生产，优质的产品和服务。

Cost-Effective

Automated assembly line and large-scale production, quality products and services.

ENTERPRISE QUALIFICATION

企业资质



商标注册证



ISO 9001



麦克风的静音保护电路专利



电池组保护电路专利



插座保护模块专利



USB接口保护电路专利



CAN总线保护电路专利



RS 485防护电路专利



RS 232防护电路专利



MOSFET栅源保护电路专利



LED驱动电源雷击浪涌防护电路专利



LCD保护电路专利



IEEE1394接口保护电路专利



ESD选型软件



TVS选型软件

OUR ADVANTAGES

我们的优势



质量稳定

测试手段完备，产品符合相关国际国内行业标准。

High Quality

Complete testing methods, products meet relevant international and domestic industry standards.



服务周到

可提供技术支持、方案设计、测试评估增值服务

Good Service

Professional technical support, project design, testing and evaluation services.



交货准时

配置先进PMC系统，强大的常规器件备库能力。

Fast Delivery

Advanced PMC system and effective warehouse management system.



性价比高

自动化流水线，规模化生产，优质的产品和服务。

Cost-Effective

Automated assembly line and large-scale production, quality products and services.

ENTERPRISE QUALIFICATION

企业资质



商标注册证



ISO 9001



麦克风的静音保护电路专利



电池组保护电路专利



插座保护模块专利



USB接口保护电路专利



CAN总线保护电路专利



RS 485防护电路专利



RS 232防护电路专利



MOSFET栅源保护电路专利



LED驱动电源雷击浪涌防护电路专利



LCD保护电路专利



IEEE1394接口保护电路专利



ESD选型软件



TVS选型软件

中国电子元件行业协会成员

中国汽车工业协会理事单位

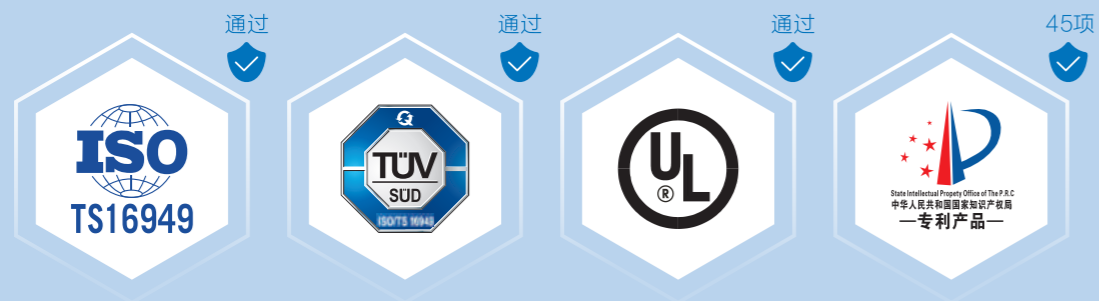

中国电子元件行业协会成员

中国汽车工业协会理事单位



01 瞬态抑制二极管 01

Transient Voltage Suppressors

SMF Series 200W	03
SMAJ Series 400W	05
SMBJ Series 600W	07
P6SMB Series 600W	09
P8SMB Series 800W	10
1.0SMB Series 1000W	12
SMCJ Series 1500W	13
SMDJ Series 3000W	15
5.0SMDJ Series 5000W	17
SM8 Series 6600W	19
SA Series 500W	20
P6KE Series 600W	22
1.5KE Series 1500W	24
3KP Series 3000W	26
5KP Series 5000W	28
15KP Series 15000W	31

02 静电保护器件 33

Electro Static Discharge Devices

SOD323	35
SOD523	37
SOD882	38
SOD923	39
SOT23	40
DFN	43
SOT-143	45
SOT23-6L	47
SOP-8	48
SOT-553	49
SOT-353	50
SOT-563	51
SOT-363	52
SMD	53

03 半导体放电管 54

Thyristor Surge Suppressors

SOD-123FL----DA Series	56
SMA/DO-214AC----TA Series	57
SMB/DO-214AA----S Series	58
DO-15/DO-27----L Series	59

04 气体放电管 61

Gas Discharge Tubes

SMD 1206 Series	62
SMD 1812 Series	63
2R***S-6 x 4.2 Series	64
2R***S-8 x 6 Series	65
2R***L-5.5 x 6 Series	66
2R***L-8 x 6 Series	67
3R***S-5 x 7.6 Series	68
3R***S-6 x 8 Series	69
3R***L-5 x 7.6 Series	70
3R***L-6 x 8 Series	71
3R***L-8 x 10 Series	72

05 压敏电阻 73

Metal Oxide Varistors

5D K系列	75
7D K系列	78
10D K系列	81
14D K系列	84
20D K系列	87
25D 系列	91
32D 系列	93
34S 系列	95

06 自恢复保险丝 97

Polymeric Positive Temperature Coefficient

0603 Series	100
0805 Series	101
1206 Series	102
1210 Series	104
1812 Series	105
2920 Series	107
16V Series	109
30V Series	112
60V Series	115
72V Series	118
130V Series	121
250V Series	124
600V Series	127

07 热敏电阻 129

Negative Temperature Coefficient

MF 72 Series	131
MF 52 Series	135
MF 58 Series	137

08 肖特基二极管 139

Schottky Barrier Rectifiers

SOD-123FL(1A/2A/3A) Series	140
SMA(1A/2A/3A) Series	142
SMB(2A/3A) Series	143
SMC(3A/5A) Series	144
SOT23 Series	146

09 整流二极管 148

Rectifier Diode

普通整流二极管	149
快速恢复二极管	150
高效整流二极管	151
超快恢复二极管	153

10 高压二极管 157

High Voltage Rectifier Diode

11 稳压二极管 159

Zener Diode

Y1ZD xxx Series	159
Y1ZP35D xxx Series	161
Y3ZP2D xxx Series	163
Y5ZP2D xxx Series	165
YA1ZD xxx Series	167
YAZ1P5D xxx Series	169
YAZ2D xxx Series	171

12 场效应管 175

Metal Oxide Semiconductor Field Effect Transistor

Trench MOSFET	178
SGT MOSFET	182
VDMOS	185
SJ MOSFET	188
Multi MOS	189

13 霍尔传感器 190

Hall Sensor

14 热保护器 191

Thermal Protector

15 共模滤波器 195

Common Mode Filter

YC2M 2012B Series	196
YC2H 2012G Series	197
YC2M 1012B Series	198
YC2H 1012G Series	199

16 低压差线性稳压器 200

Low Dropout Regulator

01 瞬态抑制二极管 01

Transient Voltage Suppressors

SMF Series 200W	03
SMAJ Series 400W	05
SMBJ Series 600W	07
P6SMB Series 600W	09
P8SMB Series 800W	10
1.0SMB Series 1000W	12
SMCJ Series 1500W	13
SMDJ Series 3000W	15
5.0SMDJ Series 5000W	17
SM8 Series 6600W	19
SA Series 500W	20
P6KE Series 600W	22
1.5KE Series 1500W	24
3KP Series 3000W	26
5KP Series 5000W	28
15KP Series 15000W	31

02 静电保护器件 33

Electro Static Discharge Devices

SOD323	35
SOD523	37
SOD882	38
SOD923	39
SOT23	40
DFN	43
SOT-143	45
SOT23-6L	47
SOP-8	48
SOT-553	49
SOT-353	50
SOT-563	51
SOT-363	52
SMD	53

03 半导体放电管 54

Thyristor Surge Suppressors

SOD-123FL----DA Series	56
SMA/DO-214AC----TA Series	57
SMB/DO-214AA----S Series	58
DO-15/DO-27----L Series	59

04 气体放电管 61

Gas Discharge Tubes

SMD 1206 Series	62
SMD 1812 Series	63
2R***S-6 x 4.2 Series	64
2R***S-8 x 6 Series	65
2R***L-5.5 x 6 Series	66
2R***L-8 x 6 Series	67
3R***S-5 x 7.6 Series	68
3R***S-6 x 8 Series	69
3R***L-5 x 7.6 Series	70
3R***L-6 x 8 Series	71
3R***L-8 x 10 Series	72

05 压敏电阻 73

Metal Oxide Varistors

5D K系列	75
7D K系列	78
10D K系列	81
14D K系列	84
20D K系列	87
25D 系列	91
32D 系列	93
34S 系列	95

06 自恢复保险丝 97

Polymeric Positive Temperature Coefficient

0603 Series	100
0805 Series	101
1206 Series	102
1210 Series	104
1812 Series	105
2920 Series	107
16V Series	109
30V Series	112
60V Series	115
72V Series	118
130V Series	121
250V Series	124
600V Series	127

07 热敏电阻 129

Negative Temperature Coefficient

MF 72 Series	131
MF 52 Series	135
MF 58 Series	137

08 肖特基二极管 139

Schottky Barrier Rectifiers

SOD-123FL(1A/2A/3A) Series	140
SMA(1A/2A/3A) Series	142
SMB(2A/3A) Series	143
SMC(3A/5A) Series	144
SOT23 Series	146

09 整流二极管 148

Rectifier Diode

普通整流二极管	149
快速恢复二极管	150
高效整流二极管	151
超快恢复二极管	153

10 高压二极管 157

High Voltage Rectifier Diode

11 稳压二极管 159

Zener Diode

Y1ZD xxx Series	159
Y1ZP35D xxx Series	161
Y3ZP2D xxx Series	163
Y5ZP2D xxx Series	165
YA1ZD xxx Series	167
YAZ1P5D xxx Series	169
YAZ2D xxx Series	171

12 场效应管 175

Metal Oxide Semiconductor Field Effect Transistor

Trench MOSFET	178
SGT MOSFET	182
VDMOS	185
SJ MOSFET	188
Multi MOS	189

13 霍尔传感器 190

Hall Sensor

14 热保护器 191

Thermal Protector

15 共模滤波器 195

Common Mode Filter

YC2M 2012B Series	196
YC2H 2012G Series	197
YC2M 1012B Series	198
YC2H 1012G Series	199

16 低压差线性稳压器 200

Low Dropout Regulator

瞬态抑制二极管 TVS (Transient Voltage Suppressors)

TVS是一种限压型的过压保护器，它将过高的电压钳制至一个安全范围，藉以保护后面的电路，有着比其它保护元件更快的反应时间，这使TVS可用在防护lighting、switching、ESD等快速破坏性瞬态电压。

TVS广泛应用在敏感电子零件过压保护，包括电脑、通讯、工业产品、消费性电子及汽车市场。

TVS Diode is a type of voltage suppressing device that limits over voltages to a safe range to prevent circuit from damaging and has a faster response time than other protection components. This allows TVS to be used in suppressing fast damaging transient voltage, such as lighting, switching, ESD, etc. TVS Diodes are widely used in over voltage protection of sensitive electronic components, including computer, telecommunication, industrial products, consumer electronic, automotive market, etc.



应用 Application

- ▲ 家用电器 Home appliances
- ▲ 家用娱乐系统 Family entertainment
- ▲ 移动设备 Mobile Devices
- ▲ 汽车 Auto
- ▲ 工业控制 Industrial Control
- ▲ 电脑 等 PC etc.
- ▲ 通信设备 Communication Equipment
- ▲ 照明 Lighting

I-V Curve Characteristics

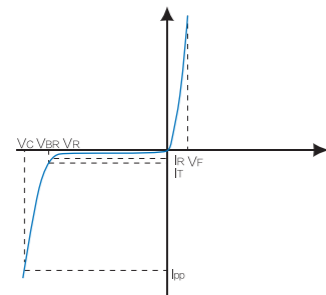

Uni-directional

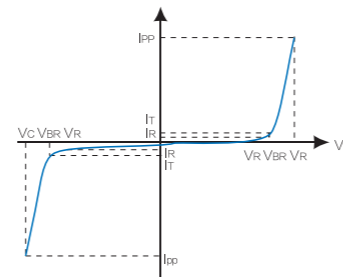

Bi-directional

V_R	Reverse Stand off Voltage	反向关断电压，当TVS两端电压小于等于此值时，TVS处于截止状态
V_{BR}	Breakdown Voltage	击穿电压，当TVS两端电压大于此值时，TVS开始导通
V_C	Maximum Clamping Voltage@ I_{PP}	钳位电压，正常情况下TVS两端电压不会大于此值
I_R	Maximum Reverse Leakage@ V_R	最大漏电流
I_T	Test current	测试电流
I_{PP}	Maximum Reverse Surge Current	最大反向浪涌电流，当通过TVS的电流超过此值时，TVS可能损坏。通常情况下TVS使用10/1000 μ s波形的电流源测试所得。

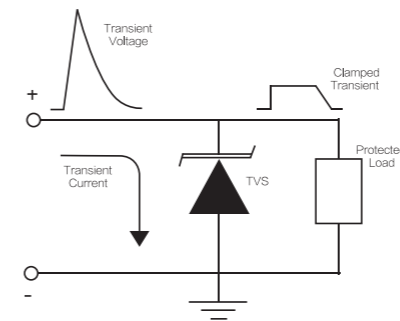

Figure 1. Transient Current is Diverted to Ground Through TVS

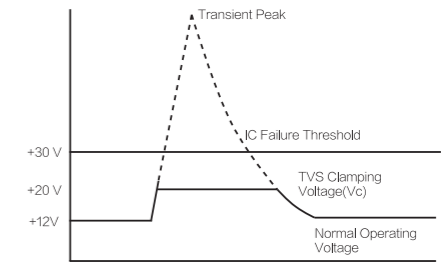

Figure 2. Transients of Several Thousand Volts can be "clamped" to a Safe Level by the TVS

在这个电路中，正常情况下TVS是不工作的，只有当电路中出现异常浪涌TVS才会起作用。TVS的参数如：击穿电压（VBR），漏电流（IR）和寄生电容C都不能影响电路的正常工作。TVS的击穿电压通常比反向关断电压高10%

In a circuit, TVS is often "hidden" until a transient event occurs, the electrical parameters such as: Breakdown Voltage (VBR), leakage current (IR) and capacitor C should not affect normal circuit operation.

TVS Breakdown Voltage (VBR) is often higher than the reverse voltage (VRWM) value of 10%.

Pppm(W)	Device	Package	
		Family	Type
200	SMF Series	Surface Mount	SOD-123FL
400	SMAJ Series	Surface Mount	DO-214AC (SMA)
500	SA Series	Plastic axial	DO-15
600	SMBJ Series	Surface Mount	DO-214AA (SMB)
	P6SMB Series	Surface Mount	DO-214AA (SMB)
800	P6KE Series	Plastic axial	DO-15
	P8SMB Series	Surface Mount	DO-214AA (SMB)
1000	1.0SMB Series	Surface Mount	DO-214AA (SMB)
1500	SMCJ Series	Surface Mount	DO-214AB (SMC)
	1.5KE Series	Plastic axial	DO-201
3000	SMDJ Series	Surface Mount	DO-214AB (SMC)
	3KP Series	Plastic axial	P600
5000	5.0SMDJ Series	Surface Mount	DO-214AB (SMC)
	5KP Series	Plastic axial	P600
6600	SM8 Series	Surface Mount	DO-218AB
8000	8KP Series	Plastic axial	P600
15000	15KP Series	Plastic axial	P600

瞬态抑制二极管 TVS (Transient Voltage Suppressors)

TVS是一种限压型的过压保护器，它将过高的电压钳制至一个安全范围，藉以保护后面的电路，有着比其它保护元件更快的反应时间，这使TVS可用在防护lighting、switching、ESD等快速破坏性瞬态电压。

TVS广泛应用在敏感电子零件过压保护，包括电脑、通讯、工业产品、消费性电子及汽车市场。

TVS Diode is a type of voltage suppressing device that limits over voltages to a safe range to prevent circuit from damaging and has a faster response time than other protection components. This allows TVS to be used in suppressing fast damaging transient voltage, such as lighting, switching, ESD, etc. TVS Diodes are widely used in over voltage protection of sensitive electronic components, including computer, telecommunication, industrial products, consumer electronic, automotive market, etc.



应用 Application

- ▲ 家用电器 Home appliances
- ▲ 家用娱乐系统 Family entertainment
- ▲ 移动设备 Mobile Devices
- ▲ 汽车 Auto
- ▲ 工业控制 Industrial Control
- ▲ 电脑 等 PC etc.
- ▲ 通信设备 Communication Equipment
- ▲ 照明 Lighting

I-V Curve Characteristics

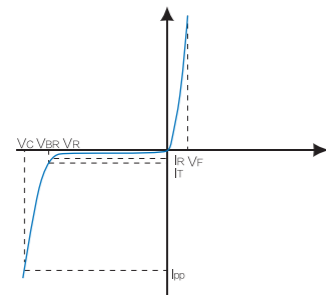

Uni-directional

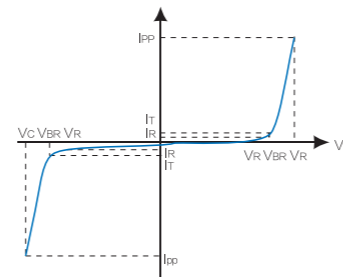

Bi-directional

V_R	Reverse Stand off Voltage	反向关断电压，当TVS两端电压小于等于此值时，TVS处于截止状态
V_{BR}	Breakdown Voltage	击穿电压，当TVS两端电压大于此值时，TVS开始导通
V_C	Maximum Clamping Voltage@ I_{PP}	钳位电压，正常情况下TVS两端电压不会大于此值
I_R	Maximum Reverse Leakage@ V_R	最大漏电流
I_T	Test current	测试电流
I_{PP}	Maximum Reverse Surge Current	最大反向浪涌电流，当通过TVS的电流超过此值时，TVS可能损坏。通常情况下TVS使用10/1000 μ s波形的电流源测试所得。

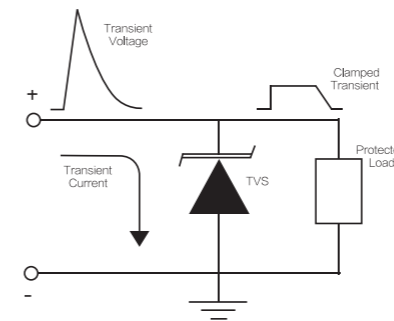

Figure 1. Transient Current is Diverted to Ground Through TVS

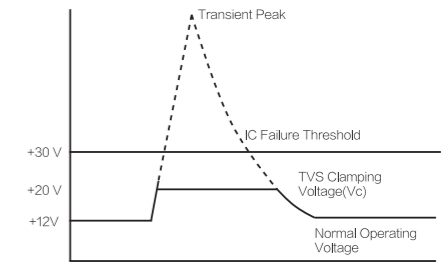

Figure 2. Transients of Several Thousand Volts can be "clamped" to a Safe Level by the TVS

在这个电路中，正常情况下TVS是不工作的，只有当电路中出现异常浪涌TVS才会起作用。TVS的参数如：击穿电压（VBR），漏电流（IR）和寄生电容C都不能影响电路的正常工作。TVS的击穿电压通常比反向关断电压高10%

In a circuit, TVS is often "hidden" until a transient event occurs, the electrical parameters such as: Breakdown Voltage (VBR), leakage current (IR) and capacitor C should not affect normal circuit operation.

TVS Breakdown Voltage (VBR) is often higher than the reverse voltage (VRWM) value of 10%.

Pppm(W)	Device	Package	
		Family	Type
200	SMF Series	Surface Mount	SOD-123FL
400	SMAJ Series	Surface Mount	DO-214AC (SMA)
500	SA Series	Plastic axial	DO-15
600	SMBJ Series	Surface Mount	DO-214AA (SMB)
	P6SMB Series	Surface Mount	DO-214AA (SMB)
800	P6KE Series	Plastic axial	DO-15
	P8SMB Series	Surface Mount	DO-214AA (SMB)
1000	1.0SMB Series	Surface Mount	DO-214AA (SMB)
	SMCJ Series	Surface Mount	DO-214AB (SMC)
1500	1.5KE Series	Plastic axial	DO-201
	SMDJ Series	Surface Mount	DO-214AB (SMC)
3000	3KP Series	Plastic axial	P600
	5.0SMDJ Series	Surface Mount	DO-214AB (SMC)
5000	5KP Series	Plastic axial	P600
	SM8 Series	Surface Mount	DO-218AB
6600	8KP Series	Plastic axial	P600
8000	15KP Series	Plastic axial	P600

SMF Series 200W (SOD-123FL)



Part Number (Bi)	Part Number (Uni)	Marking		Reverse Stand off Voltage V_R (Volts)	Breakdown Voltage V_{BR} (Volts)@ I_R		Test Current I_R (mA)	Maximum Reverse Leakage $I_{R@V_R}$ (μA)	Maximum Peak Pulse Current I_{pp} (A)	Maximum Clamping Voltage $V_C@I_{pp}$ (V)
		BI	UNI		Min .V	Max.V				
SMF5.0CA	SMF5.0A	5.0CA	5.0A	5.0	6.40	7.00	10	400	21.70	9.2
SMF6.0CA	SMF6.0A	6.0CA	6.0A	6.0	6.67	7.37	10	400	19.40	10.3
SMF6.5CA	SMF6.5A	6.5CA	6.5A	6.5	7.22	7.98	10	250	17.90	11.2
SMF7.0CA	SMF7.0A	7.0CA	7.0A	7.0	7.78	8.60	10	100	16.70	12.0
SMF7.5CA	SMF7.5A	7.5CA	7.5A	7.5	8.33	9.21	1.0	50	15.50	12.9
SMF8.0CA	SMF8.0A	8.0CA	8.0A	8.0	8.89	9.83	1.0	25	14.70	13.6
SMF8.5CA	SMF8.5A	8.5CA	8.5A	8.5	9.44	10.4	1.0	10	13.90	14.4
SMF9.0CA	SMF9.0A	9.0CA	9.0A	9	10.0	11.1	1.0	5.0	13.00	15.4
SMF10CA	SMF10A	10CA	10A	10	11.1	12.3	1.0	2.0	11.80	17.0
SMF11CA	SMF11A	11CA	11A	11	12.2	13.5	1.0	2.0	11.00	18.2
SMF12CA	SMF12A	12CA	12A	12	13.3	14.7	1.0	2.0	10.10	19.9
SMF13CA	SMF13A	13CA	13A	13	14.4	15.9	1.0	1.0	9.30	21.5
SMF14CA	SMF14A	14CA	14A	14	15.6	17.2	1.0	1.0	8.62	23.2
SMF15CA	SMF15A	15CA	15A	15	16.7	18.5	1.0	1.0	8.20	24.4
SMF16CA	SMF16A	16CA	16A	16	17.8	19.7	1.0	1.0	7.69	26.0
SMF17CA	SMF17A	17CA	17A	17	18.9	20.9	1.0	1.0	7.25	27.6
SMF18CA	SMF18A	18CA	18A	18	20.0	22.1	1.0	1.0	6.85	29.2
SMF19CA	SMF19A	19CA	19A	19	21.0	23.3	1.0	1.0	6.54	30.6
SMF20CA	SMF20A	20CA	20A	20	22.2	24.5	1.0	1.0	6.17	32.4
SMF22CA	SMF22A	22CA	22A	22	24.4	26.9	1.0	1.0	5.63	35.5
SMF24CA	SMF24A	24CA	24A	24	26.7	29.5	1.0	1.0	5.14	38.9
SMF26CA	SMF26A	26CA	26A	26	28.9	31.9	1.0	1.0	4.75	42.1
SMF28CA	SMF28A	28CA	28A	28	31.1	34.4	1.0	1.0	4.41	45.4
SMF30CA	SMF30A	30CA	30A	30	33.3	36.8	1.0	1.0	4.13	48.4
SMF33CA	SMF33A	33CA	33A	33	36.7	40.6	1.0	1.0	3.75	53.3
SMF36CA	SMF36A	36CA	36A	36	40.0	44.2	1.0	1.0	3.44	58.1
SMF40CA	SMF40A	40CA	40A	40	44.4	49.1	1.0	1.0	3.10	64.5
SMF43CA	SMF43A	43CA	43A	43	47.8	52.8	1.0	1.0	2.88	69.4
SMF45CA	SMF45A	45CA	45A	45	50.0	55.3	1.0	1.0	2.75	72.7
SMF48CA	SMF48A	48CA	48A	48	53.3	58.9	1.0	1.0	2.58	77.4
SMF51CA	SMF51A	51CA	51A	51	56.7	62.7	1.0	1.0	2.43	82.4
SMF54CA	SMF54A	54CA	54A	54	60.0	66.3	1.0	1.0	2.30	87.1
SMF58CA	SMF58A	58CA	58A	58	64.4	71.2	1.0	1.0	2.14	93.6
SMF60CA	SMF60A	60CA	60A	60	66.7	73.7	1.0	1.0	2.07	96.8
SMF64CA	SMF64A	64CA	64A	64	71.1	78.6	1.0	1.0	1.94	103
SMF70CA	SMF70A	70CA	70A	70	77.8	86.0	1.0	1.0	1.77	113
SMF75CA	SMF75A	75CA	75A	75	83.3	92.1	1.0	1.0	1.65	121

SMF Series 200W (SOD-123FL)

Part Number (Bi)	Part Number (Uni)	Marking		Reverse Stand off Voltage V_R (Volts)	Breakdown Voltage V_{BR} (Volts)@ I_R		Test Current I_R (mA)	Maximum Reverse Leakage $I_{R@V_R}$ (μA)	Maximum Peak Pulse Current I_{pp} (A)	Maximum Clamping Voltage $V_C@I_{pp}$ (V)
		BI	UNI		Min .V	Max.V				
SMF78CA	SMF78A	78CA	78A	78	86.7	95.8	1.0	1.0	1.59	126
SMF80CA	SMF80A	80CA	80A	80	88.8	97.6	1.0	1.0	1.55	129
SMF85CA	SMF85A	85CA	85A	85	94.4	104	1.0	1.0	1.46	137
SMF90CA	SMF90A	90CA	90A	90	100	111	1.0	1.0	1.37	146
SMF100CA	SMF100A	100CA	100A	100	111	123	1.0	1.0	1.23	162
SMF110CA	SMF110A	110CA	110A	110	122	135	1.0	1.0	1.13	177
SMF120CA	SMF120A	120CA	120A	120	133	147	1.0	1.0	1.04	193
SMF130CA	SMF130A	130CA	130A	130	144	159	1.0	1.0	0.96	209
SMF140CA	SMF140A	140CA	140A	140	155	171	1.0	1.0	0.89	224
SMF150CA	SMF150A	150CA	150A	150	167	185	1.0	1.0	0.82	243
SMF160CA	SMF160A	160CA	160A	160	178	197	1.0	1.0	0.77	259
SMF170CA	SMF170A	170CA	170A	170	189	209	1.0	1.0	0.73	275
SMF180CA	SMF180A	180CA	180A	180	200	220	1.0	1.0	0.69	290

PACKAGE OUTLINE DIMENSIONS in millimeters (inches) SOD123FL

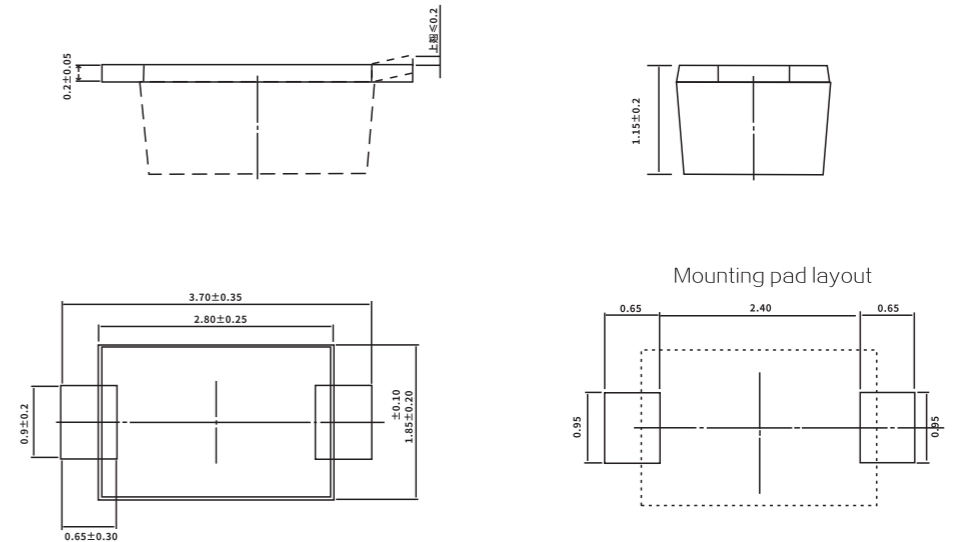

SMF Series 200W (SOD-123FL)



Part Number (Bi)	Part Number (Uni)	Marking		Reverse Stand off Voltage V_R (Volts)	Breakdown Voltage V_{BR} (Volts)@I _r		Test Current I _r (mA)	Maximum Reverse Leakage I_R @ V_R (μ A)	Maximum Peak Pulse Current I _{pp} (A)	Maximum Clamping Voltage V_C @I _{pp} (V)
		BI	UNI		Min .V	Max.V				
SMF5.0CA	SMF5.0A	5.0CA	5.0A	5.0	6.40	7.00	10	400	21.70	9.2
SMF6.0CA	SMF6.0A	6.0CA	6.0A	6.0	6.67	7.37	10	400	19.40	10.3
SMF6.5CA	SMF6.5A	6.5CA	6.5A	6.5	7.22	7.98	10	250	17.90	11.2
SMF7.0CA	SMF7.0A	7.0CA	7.0A	7.0	7.78	8.60	10	100	16.70	12.0
SMF7.5CA	SMF7.5A	7.5CA	7.5A	7.5	8.33	9.21	1.0	50	15.50	12.9
SMF8.0CA	SMF8.0A	8.0CA	8.0A	8.0	8.89	9.83	1.0	25	14.70	13.6
SMF8.5CA	SMF8.5A	8.5CA	8.5A	8.5	9.44	10.4	1.0	10	13.90	14.4
SMF9.0CA	SMF9.0A	9.0CA	9.0A	9	10.0	11.1	1.0	5.0	13.00	15.4
SMF10CA	SMF10A	10CA	10A	10	11.1	12.3	1.0	2.0	11.80	17.0
SMF11CA	SMF11A	11CA	11A	11	12.2	13.5	1.0	2.0	11.00	18.2
SMF12CA	SMF12A	12CA	12A	12	13.3	14.7	1.0	2.0	10.10	19.9
SMF13CA	SMF13A	13CA	13A	13	14.4	15.9	1.0	1.0	9.30	21.5
SMF14CA	SMF14A	14CA	14A	14	15.6	17.2	1.0	1.0	8.62	23.2
SMF15CA	SMF15A	15CA	15A	15	16.7	18.5	1.0	1.0	8.20	24.4
SMF16CA	SMF16A	16CA	16A	16	17.8	19.7	1.0	1.0	7.69	26.0
SMF17CA	SMF17A	17CA	17A	17	18.9	20.9	1.0	1.0	7.25	27.6
SMF18CA	SMF18A	18CA	18A	18	20.0	22.1	1.0	1.0	6.85	29.2
SMF19CA	SMF19A	19CA	19A	19	21.0	23.3	1.0	1.0	6.54	30.6
SMF20CA	SMF20A	20CA	20A	20	22.2	24.5	1.0	1.0	6.17	32.4
SMF22CA	SMF22A	22CA	22A	22	24.4	26.9	1.0	1.0	5.63	35.5
SMF24CA	SMF24A	24CA	24A	24	26.7	29.5	1.0	1.0	5.14	38.9
SMF26CA	SMF26A	26CA	26A	26	28.9	31.9	1.0	1.0	4.75	42.1
SMF28CA	SMF28A	28CA	28A	28	31.1	34.4	1.0	1.0	4.41	45.4
SMF30CA	SMF30A	30CA	30A	30	33.3	36.8	1.0	1.0	4.13	48.4
SMF33CA	SMF33A	33CA	33A	33	36.7	40.6	1.0	1.0	3.75	53.3
SMF36CA	SMF36A	36CA	36A	36	40.0	44.2	1.0	1.0	3.44	58.1
SMF40CA	SMF40A	40CA	40A	40	44.4	49.1	1.0	1.0	3.10	64.5
SMF43CA	SMF43A	43CA	43A	43	47.8	52.8	1.0	1.0	2.88	69.4
SMF45CA	SMF45A	45CA	45A	45	50.0	55.3	1.0	1.0	2.75	72.7
SMF48CA	SMF48A	48CA	48A	48	53.3	58.9	1.0	1.0	2.58	77.4
SMF51CA	SMF51A	51CA	51A	51	56.7	62.7	1.0	1.0	2.43	82.4
SMF54CA	SMF54A	54CA	54A	54	60.0	66.3	1.0	1.0	2.30	87.1
SMF58CA	SMF58A	58CA	58A	58	64.4	71.2	1.0	1.0	2.14	93.6
SMF60CA	SMF60A	60CA	60A	60	66.7	73.7	1.0	1.0	2.07	96.8
SMF64CA	SMF64A	64CA	64A	64	71.1	78.6	1.0	1.0	1.94	103
SMF70CA	SMF70A	70CA	70A	70	77.8	86.0	1.0	1.0	1.77	113
SMF75CA	SMF75A	75CA	75A	75	83.3	92.1	1.0	1.0	1.65	121

SMF Series 200W (SOD-123FL)

Part Number (Bi)	Part Number (Uni)	Marking		Reverse Stand off Voltage V_R (Volts)	Breakdown Voltage V_{BR} (Volts)@I _r		Test Current I _r (mA)	Maximum Reverse Leakage I_R @ V_R (μ A)	Maximum Peak Pulse Current I _{pp} (A)	Maximum Clamping Voltage V_C @I _{pp} (V)
		BI	UNI		Min .V	Max.V				
SMF78CA	SMF78A	78CA	78A	78	86.7	95.8	1.0	1.0	1.59	126
SMF80CA	SMF80A	80CA	80A	80	88.8	97.6	1.0	1.0	1.55	129
SMF85CA	SMF85A	85CA	85A	85	94.4	104	1.0	1.0	1.46	137
SMF90CA	SMF90A	90CA	90A	90	100	111	1.0	1.0	1.37	146
SMF100CA	SMF100A	100CA	100A	100	111	123	1.0	1.0	1.23	162
SMF110CA	SMF110A	110CA	110A	110	122	135	1.0	1.0	1.13	177
SMF120CA	SMF120A	120CA	120A	120	133	147	1.0	1.0	1.04	193
SMF130CA	SMF130A	130CA	130A	130	144	159	1.0	1.0	0.96	209
SMF140CA	SMF140A	140CA	140A	140	155	171	1.0	1.0	0.89	224
SMF150CA	SMF150A	150CA	150A	150	167	185	1.0	1.0	0.82	243
SMF160CA	SMF160A	160CA	160A	160	178	197	1.0	1.0	0.77	259
SMF170CA	SMF170A	170CA	170A	170	189	209	1.0	1.0	0.73	275
SMF180CA	SMF180A	180CA	180A	180	200	220	1.0	1.0	0.69	290

PACKAGE OUTLINE DIMENSIONS in millimeters (inches) SOD123FL

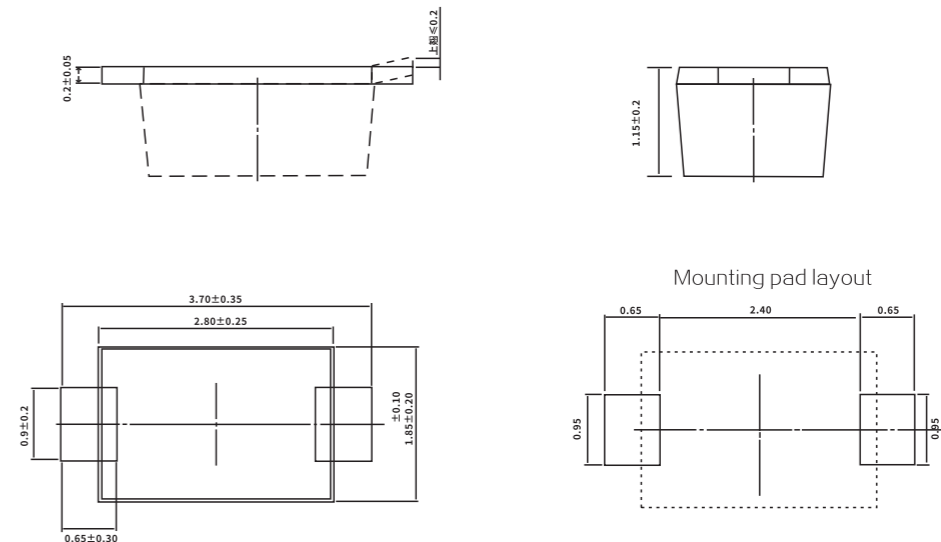

SMAJ Series 400W(DO-214AC)



Part Number (Bi)	Part Number (Uni)	Marking		Reverse Stand off Voltage V_R (Volts)	Breakdown Voltage V_{BR} (Volts)@I _r		Test Current I _r (mA)	Maximum Reverse Leakage I _R @ V_R (μ A)	Maximum Peak Pulse Current I _{pp} (A)	Maximum Clamping Voltage V_C @I _{pp} (V)
		BI	UNI		Min .V	Max.V				
SMAJ5.0CA	SMAJ5.0A	WE	AE	5.0	6.40	7.00	10	500	43.5	9.2
SMAJ6.0CA	SMAJ6.0A	WG	AG	6.0	6.67	7.37	10	500	38.8	10.3
SMAJ 6.5CA	SMAJ 6.5A	WK	AK	6.5	7.22	7.90	10	300	35.7	11.2
SMAJ7.0CA	SMAJ7.0A	WM	AM	7.0	7.78	8.60	10	200	33.3	12.0
SMAJ 7.5CA	SMAJ 7.5A	WP	AP	7.5	8.33	9.21	1	100	31.0	12.9
SMAJ 8.0CA	SMAJ 8.0A	WR	AR	8.0	8.89	9.83	1	50	29.4	13.6
SMAJ8.5CA	SMAJ8.5A	WT	AT	8.5	9.44	10.40	1	20	27.8	14.4
SMAJ9.0CA	SMAJ9.0A	WV	AV	9.0	10.00	11.10	1	10	26.0	15.4
SMAJ10CA	SMAJ10A	WX	AX	10.0	11.10	12.30	1	5	23.5	17.0
SMAJ11CA	SMAJ11A	WZ	AZ	11.0	12.20	13.50	1	1	22.0	18.2
SMAJ12CA	SMAJ12A	XE	BE	12.0	13.30	14.70	1	1	20.1	19.9
SMAJ13CA	SMAJ13A	XG	BG	13.0	14.40	15.90	1	1	18.6	21.5
SMAJ14CA	SMAJ14A	XK	BK	14.0	15.60	17.20	1	1	17.2	23.2
SMAJ15CA	SMAJ15A	XM	BM	15.0	16.70	18.50	1	1	16.4	24.4
SMAJ16CA	SMAJ16A	XP	BP	16.0	17.80	19.70	1	1	15.4	26.0
SMAJ17CA	SMAJ17A	XR	BR	17.0	18.90	20.90	1	1	14.5	27.6
SMAJ18CA	SMAJ18A	XT	BT	18.0	20.00	22.10	1	1	13.7	29.2
SMAJ20CA	SMAJ20A	XV	BV	20.0	22.20	24.50	1	1	12.3	32.4
SMAJ22CA	SMAJ22A	XX	BX	22.0	24.40	26.90	1	1	11.3	35.5
SMAJ24CA	SMAJ24A	XZ	BZ	24.0	26.70	29.50	1	1	10.3	38.9
SMAJ26CA	SMAJ26A	YE	CE	26.0	28.90	31.90	1	1	9.5	42.1
SMAJ28CA	SMAJ28A	YG	CG	28.0	31.10	34.40	1	1	8.8	45.4
SMAJ30CA	SMAJ30A	YK	CK	30.0	33.30	36.80	1	1	8.3	48.4
SMAJ33CA	SMAJ33A	YM	CM	33.0	36.70	40.60	1	1	7.5	53.3
SMAJ36CA	SMAJ36A	YP	CP	36.0	40.00	44.20	1	1	6.9	58.1
SMAJ40CA	SMAJ40A	YR	CR	40.0	44.40	49.10	1	1	6.2	64.5
SMAJ43CA	SMAJ43A	YT	CT	43.0	47.80	52.80	1	1	5.8	69.4
SMAJ45CA	SMAJ45A	YV	CV	45.0	50.00	55.30	1	1	5.5	72.7
SMAJ48CA	SMAJ48A	YX	CX	48.0	53.30	58.90	1	1	5.2	77.4
SMAJ51CA	SMAJ51A	YZ	CZ	51.0	56.70	62.70	1	1	4.9	82.4
SMAJ54CA	SMAJ54A	ZE	RE	54.0	60.00	66.30	1	1	4.6	87.1
SMAJ58CA	SMAJ58A	ZG	RG	58.0	64.40	71.20	1	1	4.3	93.6
SMAJ60CA	SMAJ60A	ZK	RK	60.0	66.70	73.70	1	1	4.1	96.8
SMAJ64CA	SMAJ64A	ZM	RM	64.0	71.10	78.60	1	1	3.9	103.0
SMAJ70CA	SMAJ70A	ZP	RP	70.0	77.80	86.00	1	1	3.5	113.0
SMAJ75CA	SMAJ75A	ZR	RR	75.0	83.30	92.10	1	1	3.3	121.0
SMAJ78CA	SMAJ78A	ZT	RT	78.0	86.70	95.80	1	1	3.2	126.0

SMAJ Series 400W(DO-214AC)

Part Number (Bi)	Part Number (Uni)	Marking		Reverse Stand off Voltage V_R (Volts)	Breakdown Voltage V_{BR} (Volts)@I _r		Test Current I _r (mA)	Maximum Reverse Leakage I _R @ V_R (μ A)	Maximum Peak Pulse Current I _{pp} (A)	Maximum Clamping Voltage V_C @I _{pp} (V)
		BI	UNI		Min .V	Max.V				
SMAJ85CA	SMAJ85A	ZV	RV	85.0	94.4	104.0	1	1	2.9	137.0
SMAJ90CA	SMAJ90A	ZX	RX	90.0	100.0	111.0	1	1	2.7	146.0
SMAJ100CA	SMAJ100A	ZZ	RZ	100.0	111.0	123.0	1	1	2.5	162.0
SMAJ110CA	SMAJ110A	VE	SE	110.0	122.0	135.0	1	1	2.3	177.0
SMAJ120CA	SMAJ120A	VG	SG	120.0	133.0	147.0	1	1	2.1	193.0
SMAJ130CA	SMAJ130A	VK	SK	130.0	144.0	159.0	1	1	1.9	209.0
SMAJ150CA	SMAJ150A	VM	SM	150.0	167.0	185.0	1	1	1.6	243.0
SMAJ160CA	SMAJ160A	VP	SP	160.0	178.0	197.0	1	1	1.5	259.0
SMAJ170CA	SMAJ170A	VR	SR	170.0	189.0	209.0	1	1	1.5	275.0
SMAJ180CA	SMAJ180A	VT	ST	180.0	201.0	222.0	1	1	1.4	292.0
SMAJ190CA	SMAJ190A	YU	SU	190.0	211.0	233.0	1	1	1.3	308.0
SMAJ200CA	SMAJ200A	VV	SV	200.0	224.0	247.0	1	1	1.2	324.0
SMAJ210CA	SMAJ210A	YW	SW	210.0	237.0	263.0	1	1	1.2	340.0
SMAJ220CA	SMAJ220A	VX	GE	220.0	246.0	272.0	1	1	1.1	356.0
SMAJ250CA	SMAJ250A	VZ	SZ	250.0	279.0	309.0	1	1	1.0	405.0
SMAJ300CA	SMAJ300A	UE	TE	300.0	335.0	371.0	1	1	0.8	486.0
SMAJ350CA	SMAJ350A	UG	TG	350.0	391.0	432.0	1	1	0.7	567.0
SMAJ400CA	SMAJ400A	UK	TK	400.0	447.0	494.0	1	1	0.6	648.0
SMAJ440CA	SMAJ440A	UM	TM	440.0	492.0	543.0	1	1	0.6	713.0

PACKAGE OUTLINE DIMENSIONS in inches (millimeters) DO-214AC

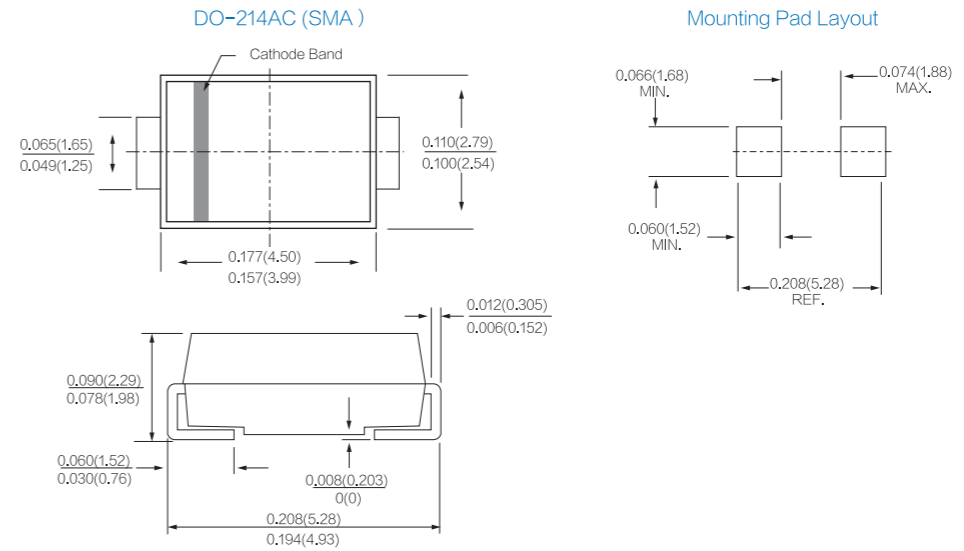

SMAJ Series 400W(DO-214AC)



Part Number (Bi)	Part Number (Uni)	Marking		Reverse Stand off Voltage V_R (Volts)	Breakdown Voltage V_{BR} (Volts)@ I_R		Test Current I_T (mA)	Maximum Reverse Leakage I_R @ V_R (μ A)	Maximum Peak Pulse Current I_{pp} (A)	Maximum Clamping Voltage V_C @ I_{pp} (V)
		BI	UNI		Min .V	Max.V				
SMAJ5.0CA	SMAJ5.0A	WE	AE	5.0	6.40	7.00	10	500	43.5	9.2
SMAJ6.0CA	SMAJ6.0A	WG	AG	6.0	6.67	7.37	10	500	38.8	10.3
SMAJ 6.5CA	SMAJ 6.5A	WK	AK	6.5	7.22	7.90	10	300	35.7	11.2
SMAJ7.0CA	SMAJ7.0A	WM	AM	7.0	7.78	8.60	10	200	33.3	12.0
SMAJ 7.5CA	SMAJ 7.5A	WP	AP	7.5	8.33	9.21	1	100	31.0	12.9
SMAJ 8.0CA	SMAJ 8.0A	WR	AR	8.0	8.89	9.83	1	50	29.4	13.6
SMAJ8.5CA	SMAJ8.5A	WT	AT	8.5	9.44	10.40	1	20	27.8	14.4
SMAJ9.0CA	SMAJ9.0A	WV	AV	9.0	10.00	11.10	1	10	26.0	15.4
SMAJ10CA	SMAJ10A	WX	AX	10.0	11.10	12.30	1	5	23.5	17.0
SMAJ11CA	SMAJ11A	WZ	AZ	11.0	12.20	13.50	1	1	22.0	18.2
SMAJ12CA	SMAJ12A	XE	BE	12.0	13.30	14.70	1	1	20.1	19.9
SMAJ13CA	SMAJ13A	XG	BG	13.0	14.40	15.90	1	1	18.6	21.5
SMAJ14CA	SMAJ14A	XK	BK	14.0	15.60	17.20	1	1	17.2	23.2
SMAJ15CA	SMAJ15A	XM	BM	15.0	16.70	18.50	1	1	16.4	24.4
SMAJ16CA	SMAJ16A	XP	BP	16.0	17.80	19.70	1	1	15.4	26.0
SMAJ17CA	SMAJ17A	XR	BR	17.0	18.90	20.90	1	1	14.5	27.6
SMAJ18CA	SMAJ18A	XT	BT	18.0	20.00	22.10	1	1	13.7	29.2
SMAJ20CA	SMAJ20A	XV	BV	20.0	22.20	24.50	1	1	12.3	32.4
SMAJ22CA	SMAJ22A	XX	BX	22.0	24.40	26.90	1	1	11.3	35.5
SMAJ24CA	SMAJ24A	XZ	BZ	24.0	26.70	29.50	1	1	10.3	38.9
SMAJ26CA	SMAJ26A	YE	CE	26.0	28.90	31.90	1	1	9.5	42.1
SMAJ28CA	SMAJ28A	YG	CG	28.0	31.10	34.40	1	1	8.8	45.4
SMAJ30CA	SMAJ30A	YK	CK	30.0	33.30	36.80	1	1	8.3	48.4
SMAJ33CA	SMAJ33A	YM	CM	33.0	36.70	40.60	1	1	7.5	53.3
SMAJ36CA	SMAJ36A	YP	CP	36.0	40.00	44.20	1	1	6.9	58.1
SMAJ40CA	SMAJ40A	YR	CR	40.0	44.40	49.10	1	1	6.2	64.5
SMAJ43CA	SMAJ43A	YT	CT	43.0	47.80	52.80	1	1	5.8	69.4
SMAJ45CA	SMAJ45A	YV	CV	45.0	50.00	55.30	1	1	5.5	72.7
SMAJ48CA	SMAJ48A	YX	CX	48.0	53.30	58.90	1	1	5.2	77.4
SMAJ51CA	SMAJ51A	YZ	CZ	51.0	56.70	62.70	1	1	4.9	82.4
SMAJ54CA	SMAJ54A	ZE	RE	54.0	60.00	66.30	1	1	4.6	87.1
SMAJ58CA	SMAJ58A	ZG	RG	58.0	64.40	71.20	1	1	4.3	93.6
SMAJ60CA	SMAJ60A	ZK	RK	60.0	66.70	73.70	1	1	4.1	96.8
SMAJ64CA	SMAJ64A	ZM	RM	64.0	71.10	78.60	1	1	3.9	103.0
SMAJ70CA	SMAJ70A	ZP	RP	70.0	77.80	86.00	1	1	3.5	113.0
SMAJ75CA	SMAJ75A	ZR	RR	75.0	83.30	92.10	1	1	3.3	121.0
SMAJ78CA	SMAJ78A	ZT	RT	78.0	86.70	95.80	1	1	3.2	126.0

SMAJ Series 400W(DO-214AC)

Part Number (Bi)	Part Number (Uni)	Marking		Reverse Stand off Voltage V_R (Volts)	Breakdown Voltage V_{BR} (Volts)@ I_R		Test Current I_T (mA)	Maximum Reverse Leakage I_R @ V_R (μ A)	Maximum Peak Pulse Current I_{pp} (A)	Maximum Clamping Voltage V_C @ I_{pp} (V)
		BI	UNI		Min .V	Max.V				
SMAJ85CA	SMAJ85A	ZV	RV	85.0	94.4	104.0	1	1	2.9	137.0
SMAJ90CA	SMAJ90A	ZX	RX	90.0	100.0	111.0	1	1	2.7	146.0
SMAJ100CA	SMAJ100A	ZZ	RZ	100.0	111.0	123.0	1	1	2.5	162.0
SMAJ110CA	SMAJ110A	VE	SE	110.0	122.0	135.0	1	1	2.3	177.0
SMAJ120CA	SMAJ120A	VG	SG	120.0	133.0	147.0	1	1	2.1	193.0
SMAJ130CA	SMAJ130A	VK	SK	130.0	144.0	159.0	1	1	1.9	209.0
SMAJ150CA	SMAJ150A	VM	SM	150.0	167.0	185.0	1	1	1.6	243.0
SMAJ160CA	SMAJ160A	VP	SP	160.0	178.0	197.0	1	1	1.5	259.0
SMAJ170CA	SMAJ170A	VR	SR	170.0	189.0	209.0	1	1	1.5	275.0
SMAJ180CA	SMAJ180A	VT	ST	180.0	201.0	222.0	1	1	1.4	292.0
SMAJ190CA	SMAJ190A	YU	SU	190.0	211.0	233.0	1	1	1.3	308.0
SMAJ200CA	SMAJ200A	VV	SV	200.0	224.0	247.0	1	1	1.2	324.0
SMAJ210CA	SMAJ210A	YW	SW	210.0	237.0	263.0	1	1	1.2	340.0
SMAJ220CA	SMAJ220A	VX	GE	220.0	246.0	272.0	1	1	1.1	356.0
SMAJ250CA	SMAJ250A	VZ	SZ	250.0	279.0	309.0	1	1	1.0	405.0
SMAJ300CA	SMAJ300A	UE	TE	300.0	335.0	371.0	1	1	0.8	486.0
SMAJ350CA	SMAJ350A	UG	TG	350.0	391.0	432.0	1	1	0.7	567.0
SMAJ400CA	SMAJ400A	UK	TK	400.0	447.0	494.0	1	1	0.6	648.0
SMAJ440CA	SMAJ440A	UM	TM	440.0	492.0	543.0	1	1	0.6	713.0

PACKAGE OUTLINE DIMENSIONS in inches (millimeters) DO-214AC

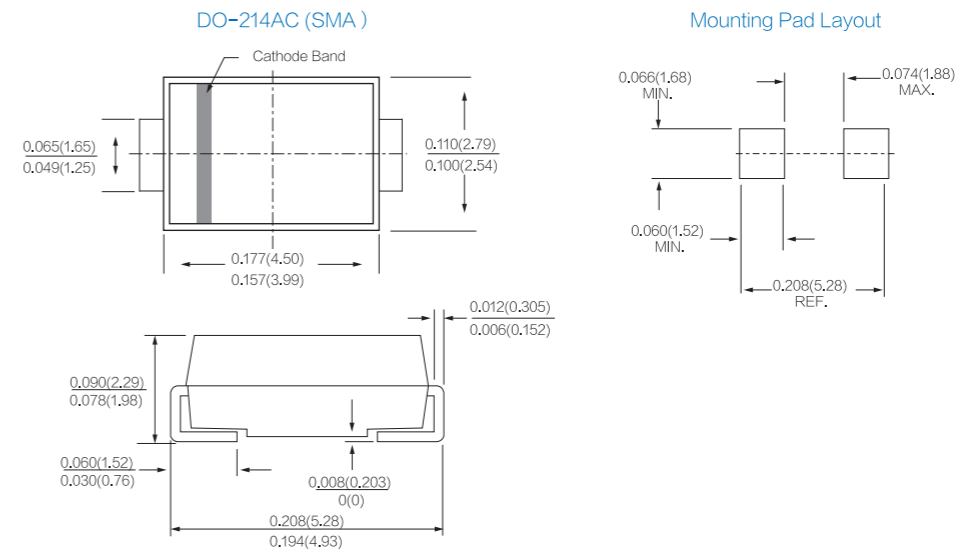

SMBJ Series 600W (DO-214AA)



Part Number (Bi)	Part Number (Uni)	Marking		Reverse Stand off Voltage V_R (Volts)	Breakdown Voltage V_{BR} (Volts)@ I_T		Test Current I_T (mA)	Maximum Reverse Leakage $I_{R@V_R}$ (μ A)	Maximum Peak Pulse Current I_{pp} (A)	Maximum Clamping Voltage $V_C@I_{pp}$ (V)
		BI	UNI		Min .V	Max.V				
SMBJ5.0CA	SMBJ5.0A	AE	KE	5.0	6.40	7.00	10	500	65.2	9.2
SMBJ6.0CA	SMBJ6.0A	AG	KG	6.0	6.67	7.37	10	500	58.3	10.3
SMBJ6.5CA	SMBJ6.5A	AK	KK	6.5	7.22	7.9	10	300	53.6	11.2
SMBJ7.0CA	SMBJ7.0A	AM	KM	7.0	7.78	8.60	10	200	50.0	12.0
SMBJ7.5CA	SMBJ7.5A	AP	KP	7.5	8.33	9.21	1	100	46.6	12.9
SMBJ8.0CA	SMBJ8.0A	AR	KR	8.0	8.89	9.83	1	50	44.2	13.6
SMBJ8.5CA	SMBJ8.5A	AT	KT	8.5	9.44	10.40	1	20	41.7	14.4
SMBJ9.0CA	SMBJ9.0A	AV	KV	9.0	10.00	11.10	1	10	39.0	15.4
SMBJ10CA	SMBJ10A	AX	KX	10.0	11.10	12.30	1	5	35.3	17.0
SMBJ11CA	SMBJ11A	AZ	KZ	11.0	12.20	13.50	1	1	33.0	18.2
SMBJ12CA	SMBJ12A	BE	LE	12.0	13.30	14.70	1	1	30.2	19.9
SMBJ13CA	SMBJ13A	BG	LG	13.0	14.40	15.90	1	1	28.0	21.5
SMBJ14CA	SMBJ14A	BK	LK	14.0	15.60	17.20	1	1	25.9	23.2
SMBJ15CA	SMBJ15A	BM	LM	15.0	16.70	18.50	1	1	24.6	24.4
SMBJ16CA	SMBJ16A	BP	LP	16.0	17.80	19.70	1	1	23.1	26.0
SMBJ17CA	SMBJ17A	BR	LR	17.0	18.90	20.90	1	1	21.8	27.6
SMBJ18CA	SMBJ18A	BT	LT	18.0	20.00	22.10	1	1	20.6	29.2
SMBJ20CA	SMBJ20A	BV	LV	20.0	22.20	24.50	1	1	18.6	32.4
SMBJ22CA	SMBJ22A	BX	LX	22.0	24.40	26.90	1	1	16.9	35.5
SMBJ24CA	SMBJ24A	BZ	LZ	24.0	26.70	29.50	1	1	15.5	38.9
SMBJ26CA	SMBJ26A	CE	ME	26.0	28.90	31.90	1	1	14.3	42.1
SMBJ28CA	SMBJ28A	CG	MG	28.0	31.10	34.40	1	1	13.3	45.4
SMBJ30CA	SMBJ30A	CK	MK	30.0	33.30	36.80	1	1	12.4	48.4
SMBJ33CA	SMBJ33A	CM	MM	33.0	36.70	40.60	1	1	11.3	53.3
SMBJ36CA	SMBJ36A	CP	MP	36.0	40.00	44.20	1	1	10.4	58.1
SMBJ40CA	SMBJ40A	CR	MR	40.0	44.40	49.10	1	1	9.3	64.5
SMBJ43CA	SMBJ43A	CT	MT	43.0	47.80	52.80	1	1	8.7	69.4
SMBJ45CA	SMBJ45A	CV	MV	45.0	50.00	55.30	1	1	8.3	72.7

SMBJ Series 600W (DO-214AA)

Part Number (Bi)	Part Number (Uni)	Marking		Reverse Stand off Voltage V_R (Volts)	Breakdown Voltage V_{BR} (Volts)@ I_T		Test Current I_T (mA)	Maximum Reverse Leakage $I_{R@V_R}$ (μ A)	Maximum Peak Pulse Current I_{pp} (A)	Maximum Clamping Voltage $V_C@I_{pp}$ (V)
		BI	UNI		Min .V	Max.V				
SMBJ48CA	SMBJ48A	CX	MX	48.0	53.30	58.90	1	1	7.8	77.4
SMBJ51CA	SMBJ51A	CZ	MZ	51.0	56.70	62.70	1	1	7.3	82.4
SMBJ54CA	SMBJ54A	DE	NE	54.0	60.00	66.30	1	1	6.9	87.1
SMBJ58CA	SMBJ58A	DG	NG	58.0	64.40	71.20	1	1	6.5	93.6
SMBJ60CA	SMBJ60A	DK	NK	60.0	66.70	73.70	1	1	6.2	96.8
SMBJ64CA	SMBJ64A	DM	NM	64.0	71.10	78.60	1	1	5.9	103.0
SMBJ70CA	SMBJ70A	DP	NP	70.0	77.80	86.00	1	1	5.3	113.0
SMBJ75CA	SMBJ75A	DR	NR	75.0	83.30	92.10	1	1	5.0	121.0
SMBJ78CA	SMBJ78A	DT	NT	78.0	86.70	95.80	1	1	4.8	126.0
SMBJ85CA	SMBJ85A	DV	NV	85.0	94.4	104.0	1	1	4.4	137.0
SMBJ90CA	SMBJ90A	DX	NX	90.0	100.0	111.0	1	1	4.1	146.0
SMBJ100CA	SMBJ100A	DZ	NZ	100.0	111.0	123.0	1	1	3.7	162.0
SMBJ110CA	SMBJ110A	EE	PE	110.0	122.0	135.0	1	1	3.4	177.0
SMBJ120CA	SMBJ120A	EG	PG	120.0	133.0	147.0	1	1	3.1	193.0
SMBJ130CA	SMBJ130A	EK	PK	130.0	144.0	159.0	1	1	2.9	209.0
SMBJ150CA	SMBJ150A	EM	PM	150.0	167.0	185.0	1	1	2.5	243.0
SMBJ160CA	SMBJ160A	EP	PP	160.0	178.0	197.0	1	1	2.3	259.0
SMBJ170CA	SMBJ170A	ER	PR	170.0	189.0	209.0	1	1	2.2	275.0
SMBJ180CA	SMBJ180A	ET	PT	180.0	201.0	222.0	1	1	2.1	292.0
SMBJ190CA	SMBJ190A	EC	PA	190.0	211.0	233.0	1	1	2.0	308.0
SMBJ200CA	SMBJ200A	EV	PV	200.0	224.0	247.0	1	1	1.9	324.0
SMBJ210CA	SMBJ210A	ED	PB	210.0	237.0	263.0	1	1	1.8	340.0
SMBJ220CA	SMBJ220A	EX	PX	220.0	246.0	272.0	1	1	1.7	356.0
SMBJ250CA	SMBJ250A	EZ	PZ	250.0	279.0	309.0	1	1	1.5	405.0
SMBJ300CA	SMBJ300A	FE	QE	300.0	335.0	371.0	1	1	1.3	486.0
SMBJ350CA	SMBJ350A	FG	QG	350.0	391.0	432.0	1	1	1.1	567.0
SMBJ400CA	SMBJ400A	FK	QK	400.0	447.0	494.0	1	1	0.9	648.0
SMBJ440CA	SMBJ440A	FM	QM	440.0	492.0	543.0	1	1	0.9	713.0

SMBJ Series 600W (DO-214AA)



Part Number (Bi)	Part Number (Uni)	Marking		Reverse Stand off Voltage V_R (Volts)	Breakdown Voltage V_{BR} (Volts)@ I_R		Test Current I_T (mA)	Maximum Reverse Leakage $I_{R@V_R}$ (μ A)	Maximum Peak Pulse Current I_{pp} (A)	Maximum Clamping Voltage $V_C@I_{pp}$ (V)
		BI	UNI		Min .V	Max.V				
SMBJ5.0CA	SMBJ5.0A	AE	KE	5.0	6.40	7.00	10	500	65.2	9.2
SMBJ6.0CA	SMBJ6.0A	AG	KG	6.0	6.67	7.37	10	500	58.3	10.3
SMBJ6.5CA	SMBJ6.5A	AK	KK	6.5	7.22	7.9	10	300	53.6	11.2
SMBJ7.0CA	SMBJ7.0A	AM	KM	7.0	7.78	8.60	10	200	50.0	12.0
SMBJ7.5CA	SMBJ7.5A	AP	KP	7.5	8.33	9.21	1	100	46.6	12.9
SMBJ8.0CA	SMBJ8.0A	AR	KR	8.0	8.89	9.83	1	50	44.2	13.6
SMBJ8.5CA	SMBJ8.5A	AT	KT	8.5	9.44	10.40	1	20	41.7	14.4
SMBJ9.0CA	SMBJ9.0A	AV	KV	9.0	10.00	11.10	1	10	39.0	15.4
SMBJ10CA	SMBJ10A	AX	KX	10.0	11.10	12.30	1	5	35.3	17.0
SMBJ11CA	SMBJ11A	AZ	KZ	11.0	12.20	13.50	1	1	33.0	18.2
SMBJ12CA	SMBJ12A	BE	LE	12.0	13.30	14.70	1	1	30.2	19.9
SMBJ13CA	SMBJ13A	BG	LG	13.0	14.40	15.90	1	1	28.0	21.5
SMBJ14CA	SMBJ14A	BK	LK	14.0	15.60	17.20	1	1	25.9	23.2
SMBJ15CA	SMBJ15A	BM	LM	15.0	16.70	18.50	1	1	24.6	24.4
SMBJ16CA	SMBJ16A	BP	LP	16.0	17.80	19.70	1	1	23.1	26.0
SMBJ17CA	SMBJ17A	BR	LR	17.0	18.90	20.90	1	1	21.8	27.6
SMBJ18CA	SMBJ18A	BT	LT	18.0	20.00	22.10	1	1	20.6	29.2
SMBJ20CA	SMBJ20A	BV	LV	20.0	22.20	24.50	1	1	18.6	32.4
SMBJ22CA	SMBJ22A	BX	LX	22.0	24.40	26.90	1	1	16.9	35.5
SMBJ24CA	SMBJ24A	BZ	LZ	24.0	26.70	29.50	1	1	15.5	38.9
SMBJ26CA	SMBJ26A	CE	ME	26.0	28.90	31.90	1	1	14.3	42.1
SMBJ28CA	SMBJ28A	CG	MG	28.0	31.10	34.40	1	1	13.3	45.4
SMBJ30CA	SMBJ30A	CK	MK	30.0	33.30	36.80	1	1	12.4	48.4
SMBJ33CA	SMBJ33A	CM	MM	33.0	36.70	40.60	1	1	11.3	53.3
SMBJ36CA	SMBJ36A	CP	MP	36.0	40.00	44.20	1	1	10.4	58.1
SMBJ40CA	SMBJ40A	CR	MR	40.0	44.40	49.10	1	1	9.3	64.5
SMBJ43CA	SMBJ43A	CT	MT	43.0	47.80	52.80	1	1	8.7	69.4
SMBJ45CA	SMBJ45A	CV	MV	45.0	50.00	55.30	1	1	8.3	72.7

SMBJ Series 600W (DO-214AA)

Part Number (Bi)	Part Number (Uni)	Marking		Reverse Stand off Voltage V_R (Volts)	Breakdown Voltage V_{BR} (Volts)@ I_R		Test Current I_T (mA)	Maximum Reverse Leakage $I_{R@V_R}$ (μ A)	Maximum Peak Pulse Current I_{pp} (A)	Maximum Clamping Voltage $V_C@I_{pp}$ (V)
		BI	UNI		Min .V	Max.V				
SMBJ48CA	SMBJ48A	CX	MX	48.0	53.30	58.90	1	1	7.8	77.4
SMBJ51CA	SMBJ51A	CZ	MZ	51.0	56.70	62.70	1	1	7.3	82.4
SMBJ54CA	SMBJ54A	DE	NE	54.0	60.00	66.30	1	1	6.9	87.1
SMBJ58CA	SMBJ58A	DG	NG	58.0	64.40	71.20	1	1	6.5	93.6
SMBJ60CA	SMBJ60A	DK	NK	60.0	66.70	73.70	1	1	6.2	96.8
SMBJ64CA	SMBJ64A	DM	NM	64.0	71.10	78.60	1	1	5.9	103.0
SMBJ70CA	SMBJ70A	DP	NP	70.0	77.80	86.00	1	1	5.3	113.0
SMBJ75CA	SMBJ75A	DR	NR	75.0	83.30	92.10	1	1	5.0	121.0
SMBJ78CA	SMBJ78A	DT	NT	78.0	86.70	95.80	1	1	4.8	126.0
SMBJ85CA	SMBJ85A	DV	NV	85.0	94.4	104.0	1	1	4.4	137.0
SMBJ90CA	SMBJ90A	DX	NX	90.0	100.0	111.0	1	1	4.1	146.0
SMBJ100CA	SMBJ100A	DZ	NZ	100.0	111.0	123.0	1	1	3.7	162.0
SMBJ110CA	SMBJ110A	EE	PE	110.0	122.0	135.0	1	1	3.4	177.0
SMBJ120CA	SMBJ120A	EG	PG	120.0	133.0	147.0	1	1	3.1	193.0
SMBJ130CA	SMBJ130A	EK	PK	130.0	144.0	159.0	1	1	2.9	209.0
SMBJ150CA	SMBJ150A	EM	PM	150.0	167.0	185.0	1	1	2.5	243.0
SMBJ160CA	SMBJ160A	EP	PP	160.0	178.0	197.0	1	1	2.3	259.0
SMBJ170CA	SMBJ170A	ER	PR	170.0	189.0	209.0	1	1	2.2	275.0
SMBJ180CA	SMBJ180A	ET	PT	180.0	201.0	222.0	1	1	2.1	292.0
SMBJ190CA	SMBJ190A	EC	PA	190.0	211.0	233.0	1	1	2.0	308.0
SMBJ200CA	SMBJ200A	EV	PV	200.0	224.0	247.0	1	1	1.9	324.0
SMBJ210CA	SMBJ210A	ED	PB	210.0	237.0	263.0	1	1	1.8	340.0
SMBJ220CA	SMBJ220A	EX	PX	220.0	246.0	272.0	1	1	1.7	356.0
SMBJ250CA	SMBJ250A	EZ	PZ	250.0	279.0	309.0	1	1	1.5	405.0
SMBJ300CA	SMBJ300A	FE	QE	300.0	335.0	371.0	1	1	1.3	486.0
SMBJ350CA	SMBJ350A	FG	QG	350.0	391.0	432.0	1	1	1.1	567.0
SMBJ400CA	SMBJ400A	FK	QK	400.0	447.0	494.0	1	1	0.9	648.0
SMBJ440CA	SMBJ440A	FM	QM	440.0	492.0	543.0	1	1	0.9	713.0

P6SMB Series 600W (DO-214AA)



Part Number (Bi)	Part Number (Uni)	Marking		Reverse Stand off Voltage V_R (Volts)	Breakdown Voltage V_{BR} (Volts)@I _r		Test Current I _r (mA)	Maximum Reverse Leakage I _R @ V_R (μ A)	Maximum Peak Pulse Current I _{pp} (A)	Maximum Clamping Voltage V_C @I _{pp} (V)
		BI	UNI		Min .V	Max.V				
P6SMB6.8CA	P6SMB6.8A	6V8C	6V8A	5.8	6.45	7.14	10	800	58.1	10.5
P6SMB7.5CA	P6SMB7.5A	7V5C	7V5A	6.4	7.13	7.88	10	500	54.0	11.3
P6SMB8.2CA	P6SMB8.2A	8V2C	8V2A	7.02	7.79	8.61	10	200	50.4	12.1
P6SMB9.1CA	P6SMB9.1A	9V1C	9V1A	7.78	8.65	9.55	10	50	45.5	13.4
P6SMB10CA	P6SMB10A	10C	10A	8.55	9.50	10.50	10	10	42.1	14.5
P6SMB11CA	P6SMB11A	11C	11A	9.40	10.50	11.60	1	5	39.1	15.6
P6SMB12CA	P6SMB12A	12C	12A	10.20	11.40	12.60	1	5	36.5	16.7
P6SMB13CA	P6SMB13A	13C	13A	11.10	12.40	13.70	1	1	33.5	18.2
P6SMB15CA	P6SMB15A	15C	15A	12.80	14.30	15.80	1	1	28.8	21.2
P6SMB16CA	P6SMB16A	16C	16A	13.60	15.20	16.80	1	1	27.1	22.5
P6SMB18CA	P6SMB18A	18C	18A	15.30	17.10	18.90	1	1	24.2	25.2
P6SMB20CA	P6SMB20A	20C	20A	17.10	19.00	21.00	1	1	22.0	27.7
P6SMB22CA	P6SMB22A	22C	22A	18.80	20.90	23.10	1	1	19.9	30.6
P6SMB24CA	P6SMB24A	24C	24A	20.50	22.80	25.20	1	1	18.4	33.2
P6SMB27CA	P6SMB27A	27C	27A	23.10	25.70	28.40	1	1	16.3	37.5
P6SMB30CA	P6SMB30A	30C	30A	25.60	28.50	31.50	1	1	14.7	41.4
P6SMB33CA	P6SMB33A	33C	33A	28.20	31.40	34.70	1	1	13.3	45.7
P6SMB36CA	P6SMB36A	36C	36A	30.80	34.20	37.80	1	1	12.2	49.9
P6SMB39CA	P6SMB39A	39C	39A	33.30	37.10	41.00	1	1	11.3	53.9
P6SMB43CA	P6SMB43A	43C	43A	36.80	40.90	45.20	1	1	10.3	59.3
P6SMB47CA	P6SMB47A	47C	47A	40.20	44.70	49.40	1	1	9.4	64.8
P6SMB51CA	P6SMB51A	51C	51A	43.60	48.50	53.60	1	1	8.7	70.1
P6SMB56CA	P6SMB56A	56C	56A	47.80	53.20	58.80	1	1	7.9	77.0
P6SMB62CA	P6SMB62A	62C	62A	53.00	58.90	65.10	1	1	7.2	85.0
P6SMB68CA	P6SMB68A	68C	68A	58.10	64.60	71.40	1	1	6.6	92.0
P6SMB75CA	P6SMB75A	75C	75A	64.10	71.30	78.00	1	1	5.9	103.0
P6SMB82CA	P6SMB82A	82C	82A	70.10	77.90	86.10	1	1	5.4	113.0
P6SMB91CA	P6SMB91A	91C	91A	77.80	86.50	95.50	1	1	4.9	125.0
P6SMB100CA	P6SMB100A	100C	100A	85.50	95.0	105.0	1	1	4.5	137.0
P6SMB110CA	P6SMB110A	110C	110A	94.00	105.0	116.0	1	1	4.0	152.0
P6SMB120CA	P6SMB120A	120C	120A	102.0	114.0	126.0	1	1	3.7	165.0
P6SMB130CA	P6SMB130A	130C	130A	111.0	124.0	137.0	1	1	3.4	179.0
P6SMB150CA	P6SMB150A	150C	150A	128.0	143.0	158.0	1	1	2.9	207.0
P6SMB160CA	P6SMB160A	160C	160A	136.0	152.0	168.0	1	1	2.8	219.0
P6SMB170CA	P6SMB170A	170C	170A	145.0	162.0	179.0	1	1	2.6	234.0
P6SMB180CA	P6SMB180A	180C	180A	154.0	171.0	189.00	1	1	2.5	246.0
P6SMB200CA	P6SMB200A	200C	200A	171.0	190.0	210.0	1	1	2.2	274.0

P8SMB Series 800W (DO-214AA)



Part Number (Bi)	Part Number (Uni)	Reverse Stand off Voltage V_R (Volts)	Breakdown Voltage V_{BR} (Volts)@I _r		Test Current I _r (mA)	Maximum Reverse Leakage I _R @ V_R (μ A)	Maximum Peak Pulse Current I _{pp} (A)	Maximum Clamping Voltage V_C @I _{pp} (V)
			Min .V	Max.V				
P8SMB5.0CA	P8SMB5.0A	5.0	6.4	7.25	10	800	86.96	9.2
P8SMB6.0CA	P8SMB6.0A	6.0	6.67	7.67	10	800	77.67	10.3
P8SMB6.5CA	P8SMB6.5A	6.5	7.22	8.30	10	500	71.43	11.2
P8SMB7.0CA	P8SMB7.0A	7.0	7.78	8.95	10	200	66.67	12.0
P8SMB7.5CA	P8SMB7.5A	7.5	8.33	9.58	1	100	62.02	12.9
P8SMB8.0CA	P8SMB8.0A	8.0	8.89	10.23	1	50	58.82	13.6
P8SMB8.5CA	P8SMB8.5A	8.5	9.44	10.82	1	20	55.56	14.4
P8SMB9.0CA	P8SMB9.0A	9.0	10.00	11.50	1	10	51.95	15.4
P8SMB10CA	P8SMB10A	10.0	11.1	12.3	1	10	47.06	17.0
P8SMB11CA	P8SMB11A	11.0	12.20	14.00	1	1	43.96	18.2
P8SMB12CA	P8SMB12A	12.0	13.3	14.7	1	1	40.20	19.9
P8SMB13CA	P8SMB13A	13.0	14.40	16.50	1	1	37.21	21.5
P8SMB14CA	P8SMB14A	14.0	15.60	17.2	1	1	34.48	23.2
P8SMB15CA	P8SMB15A	15.0	16.70	19.20	1	1	32.79	24.4
P8SMB16CA	P8SMB16A	16.0	17.8	19.7	1	1	30.77	26.0
P8SMB17CA	P8SMB17A	17.0	18.90	21.70	1	1	28.99	27.6
P8SMB18CA	P8SMB18A	18.0	20.00	23.30	1	1	27.40	29.2
P8SMB20CA	P8SMB20A	20.0	22.20	25.50	1	1	24.69	32.4
P8SMB22CA	P8SMB22A	22.0	24.40	28.00	1	1	22.54	35.5
P8SMB24CA	P8SMB24A	24.0	26.70	30.70	1	1	20.57	38.9
P8SMB26CA	P8SMB26A	26.0	28.90	33.20	1	1	19.00	42.1
P8SMB28CA	P8SMB28A	28.0	31.10	35.80	1	1	17.62	45.4
P8SMB30CA	P8SMB30A	30.0	33.30	38.30	1	1	16.53	48.4
P8SMB33CA	P8SMB33A	33.0	36.70	42.20	1	1	15.01	53.3
P8SMB36CA	P8SMB36A	36.0	40.00	46.00	1	1	13.77	58.1

P6SMB Series 600W (DO-214AA)



Part Number (Bi)	Part Number (Uni)	Marking		Reverse Stand off Voltage V_R (Volts)	Breakdown Voltage V_{BR} (Volts)@ I_R		Test Current I_T (mA)	Maximum Reverse Leakage I_R @ V_R (μ A)	Maximum Peak Pulse Current I_{pp} (A)	Maximum Clamping Voltage V_C @ I_{pp} (V)
		BI	UNI		Min .V	Max.V				
P6SMB6.8CA	P6SMB6.8A	6V8C	6V8A	5.8	6.45	7.14	10	800	58.1	10.5
P6SMB7.5CA	P6SMB7.5A	7V5C	7V5A	6.4	7.13	7.88	10	500	54.0	11.3
P6SMB8.2CA	P6SMB8.2A	8V2C	8V2A	7.02	7.79	8.61	10	200	50.4	12.1
P6SMB9.1CA	P6SMB9.1A	9V1C	9V1A	7.78	8.65	9.55	10	50	45.5	13.4
P6SMB10CA	P6SMB10A	10C	10A	8.55	9.50	10.50	10	10	42.1	14.5
P6SMB11CA	P6SMB11A	11C	11A	9.40	10.50	11.60	1	5	39.1	15.6
P6SMB12CA	P6SMB12A	12C	12A	10.20	11.40	12.60	1	5	36.5	16.7
P6SMB13CA	P6SMB13A	13C	13A	11.10	12.40	13.70	1	1	33.5	18.2
P6SMB15CA	P6SMB15A	15C	15A	12.80	14.30	15.80	1	1	28.8	21.2
P6SMB16CA	P6SMB16A	16C	16A	13.60	15.20	16.80	1	1	27.1	22.5
P6SMB18CA	P6SMB18A	18C	18A	15.30	17.10	18.90	1	1	24.2	25.2
P6SMB20CA	P6SMB20A	20C	20A	17.10	19.00	21.00	1	1	22.0	27.7
P6SMB22CA	P6SMB22A	22C	22A	18.80	20.90	23.10	1	1	19.9	30.6
P6SMB24CA	P6SMB24A	24C	24A	20.50	22.80	25.20	1	1	18.4	33.2
P6SMB27CA	P6SMB27A	27C	27A	23.10	25.70	28.40	1	1	16.3	37.5
P6SMB30CA	P6SMB30A	30C	30A	25.60	28.50	31.50	1	1	14.7	41.4
P6SMB33CA	P6SMB33A	33C	33A	28.20	31.40	34.70	1	1	13.3	45.7
P6SMB36CA	P6SMB36A	36C	36A	30.80	34.20	37.80	1	1	12.2	49.9
P6SMB39CA	P6SMB39A	39C	39A	33.30	37.10	41.00	1	1	11.3	53.9
P6SMB43CA	P6SMB43A	43C	43A	36.80	40.90	45.20	1	1	10.3	59.3
P6SMB47CA	P6SMB47A	47C	47A	40.20	44.70	49.40	1	1	9.4	64.8
P6SMB51CA	P6SMB51A	51C	51A	43.60	48.50	53.60	1	1	8.7	70.1
P6SMB56CA	P6SMB56A	56C	56A	47.80	53.20	58.80	1	1	7.9	77.0
P6SMB62CA	P6SMB62A	62C	62A	53.00	58.90	65.10	1	1	7.2	85.0
P6SMB68CA	P6SMB68A	68C	68A	58.10	64.60	71.40	1	1	6.6	92.0
P6SMB75CA	P6SMB75A	75C	75A	64.10	71.30	78.00	1	1	5.9	103.0
P6SMB82CA	P6SMB82A	82C	82A	70.10	77.90	86.10	1	1	5.4	113.0
P6SMB91CA	P6SMB91A	91C	91A	77.80	86.50	95.50	1	1	4.9	125.0
P6SMB100CA	P6SMB100A	100C	100A	85.50	95.0	105.0	1	1	4.5	137.0
P6SMB110CA	P6SMB110A	110C	110A	94.00	105.0	116.0	1	1	4.0	152.0
P6SMB120CA	P6SMB120A	120C	120A	102.0	114.0	126.0	1	1	3.7	165.0
P6SMB130CA	P6SMB130A	130C	130A	111.0	124.0	137.0	1	1	3.4	179.0
P6SMB150CA	P6SMB150A	150C	150A	128.0	143.0	158.0	1	1	2.9	207.0
P6SMB160CA	P6SMB160A	160C	160A	136.0	152.0	168.0	1	1	2.8	219.0
P6SMB170CA	P6SMB170A	170C	170A	145.0	162.0	179.0	1	1	2.6	234.0
P6SMB180CA	P6SMB180A	180C	180A	154.0	171.0	189.00	1	1	2.5	246.0
P6SMB200CA	P6SMB200A	200C	200A	171.0	190.0	210.0	1	1	2.2	274.0

P8SMB Series 800W (DO-214AA)



Part Number (Bi)	Part Number (Uni)	Reverse Stand off Voltage V_R (Volts)	Breakdown Voltage V_{BR} (Volts)@ I_R		Test Current I_T (mA)	Maximum Reverse Leakage I_R @ V_R (μ A)	Maximum Peak Pulse Current I_{pp} (A)	Maximum Clamping Voltage V_C @ I_{pp} (V)
			Min .V	Max.V				
P8SMB5.0CA	P8SMB5.0A	5.0	6.4	7.25	10	800	86.96	9.2
P8SMB6.0CA	P8SMB6.0A	6.0	6.67	7.67	10	800	77.67	10.3
P8SMB6.5CA	P8SMB6.5A	6.5	7.22	8.30	10	500	71.43	11.2
P8SMB7.0CA	P8SMB7.0A	7.0	7.78	8.95	10	200	66.67	12.0
P8SMB7.5CA	P8SMB7.5A	7.5	8.33	9.58	1	100	62.02	12.9
P8SMB8.0CA	P8SMB8.0A	8.0	8.89	10.23	1	50	58.82	13.6
P8SMB8.5CA	P8SMB8.5A	8.5	9.44	10.82	1	20	55.56	14.4
P8SMB9.0CA	P8SMB9.0A	9.0	10.00	11.50	1	10	51.95	15.4
P8SMB10CA	P8SMB10A	10.0	11.1	12.3	1	10	47.06	17.0
P8SMB11CA	P8SMB11A	11.0	12.20	14.00	1	1	43.96	18.2
P8SMB12CA	P8SMB12A	12.0	13.3	14.7	1	1	40.20	19.9
P8SMB13CA	P8SMB13A	13.0	14.40	16.50	1	1	37.21	21.5
P8SMB14CA	P8SMB14A	14.0	15.60	17.2	1	1	34.48	23.2
P8SMB15CA	P8SMB15A	15.0	16.70	19.20	1	1	32.79	24.4
P8SMB16CA	P8SMB16A	16.0	17.8	19.7	1	1	30.77	26.0
P8SMB17CA	P8SMB17A	17.0	18.90	21.70	1	1	28.99	27.6
P8SMB18CA	P8SMB18A	18.0	20.00	23.30	1	1	27.40	29.2
P8SMB20CA	P8SMB20A	20.0	22.20	25.50	1	1	24.69	32.4
P8SMB22CA	P8SMB22A	22.0	24.40	28.00	1	1	22.54	35.5
P8SMB24CA	P8SMB24A	24.0	26.70	30.70	1	1	20.57	38.9
P8SMB26CA	P8SMB26A	26.0	28.90	33.20	1	1	19.00	42.1
P8SMB28CA	P8SMB28A	28.0	31.10	35.80	1	1	17.62	45.4
P8SMB30CA	P8SMB30A	30.0	33.30	38.30	1	1	16.53	48.4
P8SMB33CA	P8SMB33A	33.0	36.70	42.20	1	1	15.01	53.3
P8SMB36CA	P8SMB36A	36.0	40.00	46.00	1	1	13.77	58.1

P8SMB Series 800W (DO-214AA)

Part Number (Bi)	Part Number (Uni)	Reverse Stand off Voltage V_R (Volts)	Breakdown Voltage V_{BR} (Volts)@ I_R		Test Current I_T (mA)	Maximum Reverse Leakage $I_{R@V_R}$ (μ A)	Maximum Peak Pulse Current I_{pp} (A)	Maximum Clamping Voltage $V_C@I_{pp}$ (V)
			Min .V	Max.V				
P8SMB40CA	P8SMB40A	40.0	44.40	51.10	1	1	12.40	64.5
P8SMB43CA	P8SMB43A	43.0	47.80	52.80	1	1	11.53	69.4
P8SMB45CA	P8SMB45A	45.0	50.00	57.50	1	1	11.00	72.7
P8SMB48CA	P8SMB48A	48.0	53.3	58.9	1	1	10.34	77.4
P8SMB51CA	P8SMB51A	51.0	56.70	65.20	1	1	9.71	82.4
P8SMB54CA	P8SMB54A	54.0	60.0	66.3	1	1	9.18	87.1
P8SMB58CA	P8SMB58A	58.0	64.40	74.10	1	1	8.55	93.6
P8SMB60CA	P8SMB60A	60.0	66.7	73.7	1	1	8.26	96.8
P8SMB64CA	P8SMB64A	64.0	71.10	81.80	1	1	7.77	103.0
P8SMB70CA	P8SMB70A	70.0	77.80	89.50	1	1	7.08	113.0
P8SMB75CA	P8SMB75A	75.0	83.3	92.1	1	1	6.61	121.0
P8SMB78CA	P8SMB78A	78.0	86.70	99.70	1	1	6.35	126.0
P8SMB85CA	P8SMB85A	85.0	94.40	108.20	1	1	5.84	137.0
P8SMB90CA	P8SMB90A	90.0	100.0	111.0	1	1	5.48	146.0
P8SMB100CA	P8SMB100A	100.0	110.00	128.00	1	1	4.94	162.0
P8SMB110CA	P8SMB110A	110.0	122.00	140.50	1	1	4.52	177.0
P8SMB120CA	P8SMB120A	120.0	133.00	147.00	1	1	4.15	193.0
P8SMB130CA	P8SMB130A	130.0	144.00	165.50	1	1	3.83	209.0
P8SMB150CA	P8SMB150A	150.0	167.00	192.50	1	1	3.29	243.0
P8SMB160CA	P8SMB160A	160.0	178.00	197.00	1	1	3.09	259.0
P8SMB170CA	P8SMB170A	170.0	189.00	217.50	1	1	2.91	275.0
P8SMB180CA	P8SMB180A	180.0	201.00	222.00	1	1	2.74	292.0
P8SMB200CA	P8SMB200A	200.0	224.00	247.00	1	1	2.47	324.0
P8SMB220CA	P8SMB220A	220.0	246.00	272.00	1	1	2.25	356.0
P8SMB350CA	P8SMB350A	350	391	432	1	1	1.41	567

1.0SMB Series 1000W (DO-214AA)

Part Number (Bi)	Part Number (Uni)	Marking		Reverse Stand off Voltage V_R (Volts)	Breakdown Voltage V_{BR} (Volts)@ I_R		Test Current I_T (mA)	Maximum Reverse Leakage $I_{R@V_R}$ (μ A)	Maximum Peak Pulse Current I_{pp} (A)	Maximum Clamping Voltage $V_C@I_{pp}$ (V)
		BI	UNI		Min .V	Max.V				
1.0SMB6.8CA	1.0SMB6.8A	N10A	A10A	5.8	6.46	7.14	10	900	95.2	10.5
1.0SMB7.5CA	1.0SMB7.5A	N10B	A10B	6.4	7.13	7.88	10	400	88.5	11.3
1.0SMB8.2CA	1.0SMB8.2A	N10C	A10C	7.0	7.79	8.61	10	180	82.6	12.1
1.0SMB9.1CA	1.0SMB9.1A	N10D	A10D	7.8	8.65	9.56	1	45	74.6	13.4
1.0SMB10CA	1.0SMB10A	N10E	A10E	8.6	9.50	10.50	1	8	69.0	14.5
1.0SMB11CA	1.0SMB11A	N10F	A10F	9.4	10.45	11.55	1	4	64.1	15.6
1.0SMB12CA	1.0SMB12A	N10G	A10G	10.2	11.40	12.60	1	1	59.9	16.7
1.0SMB13CA	1.0SMB13A	N10H	A10H	11.1	12.35	13.65	1	1	54.9	18.2
1.0SMB15CA	1.0SMB15A	N10I	A10I	12.8	14.25	15.75	1	1	47.2	21.2
1.0SMB16CA	1.0SMB16A	N10J	A10J	13.6	15.20	16.80	1	1	44.4	22.5
1.0SMB18CA	1.0SMB18A	N10K	A10K	15.3	17.10	18.90	1	1	39.7	25.2
1.0SMB20CA	1.0SMB20A	N10L	A10L	17.1	19.00	21.00	1	1	36.1	27.7
1.0SMB22CA	1.0SMB22A	N10M	A10M	18.8	20.90	23.10	1	1	32.7	30.6
1.0SMB24CA	1.0SMB24A	N10N	A10N	20.5	22.80	25.20	1	1	30.1	33.2
1.0SMB27CA	1.0SMB27A	N10O	A10O	23.1	25.65	28.35	1	1	26.7	37.5
1.0SMB30CA	1.0SMB30A	N10P	A10P	25.6	28.50	31.50	1	1	24.2	41.4
1.0SMB33CA	1.0SMB33A	N10Q	A10Q	28.2	31.35	34.65	1	1	21.9	45.7
1.0SMB36CA	1.0SMB36A	N10R	A10R	30.8	34.20	37.80	1	1	20.0	49.9
1.0SMB39CA	1.0SMB39A	N10S	A10S	33.3	37.05	40.95	1	1	18.6	53.9
1.0SMB43CA	1.0SMB43A	N10T	A10T	36.8	40.85	45.15	1	1	16.9	59.3
1.0SMB47CA	1.0SMB47A	N10U	A10U	40.2	44.65	49.35	1	1	15.4	64.8

PACKAGE OUTLINE DIMENSIONS in inches (millimeters) DO-214AA

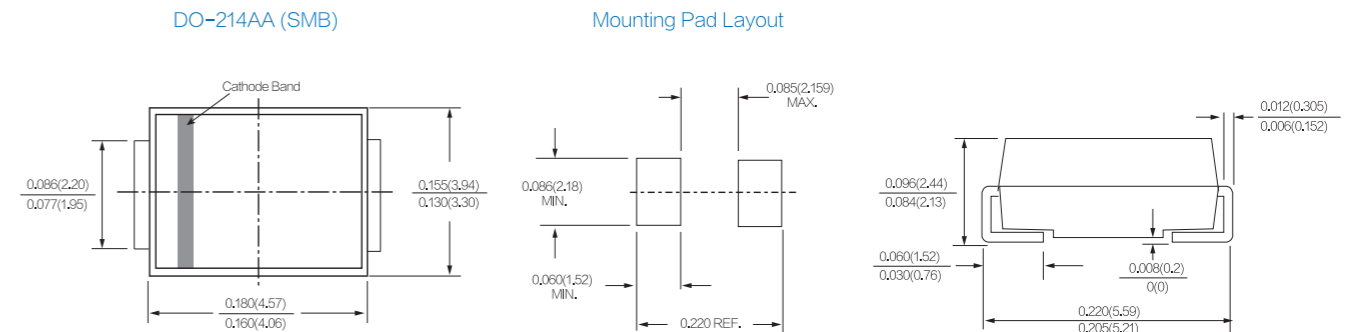

P8SMB Series 800W (DO-214AA)

Part Number (Bi)	Part Number (Uni)	Reverse Stand off Voltage V_R (Volts)	Breakdown Voltage V_{BR} (Volts)@ I_R		Test Current I_T (mA)	Maximum Reverse Leakage $I_{R@V_R}$ (μ A)	Maximum Peak Pulse Current I_{pp} (A)	Maximum Clamping Voltage $V_C@I_{pp}$ (V)
			Min .V	Max.V				
P8SMB40CA	P8SMB40A	40.0	44.40	51.10	1	1	12.40	64.5
P8SMB43CA	P8SMB43A	43.0	47.80	52.80	1	1	11.53	69.4
P8SMB45CA	P8SMB45A	45.0	50.00	57.50	1	1	11.00	72.7
P8SMB48CA	P8SMB48A	48.0	53.3	58.9	1	1	10.34	77.4
P8SMB51CA	P8SMB51A	51.0	56.70	65.20	1	1	9.71	82.4
P8SMB54CA	P8SMB54A	54.0	60.0	66.3	1	1	9.18	87.1
P8SMB58CA	P8SMB58A	58.0	64.40	74.10	1	1	8.55	93.6
P8SMB60CA	P8SMB60A	60.0	66.7	73.7	1	1	8.26	96.8
P8SMB64CA	P8SMB64A	64.0	71.10	81.80	1	1	7.77	103.0
P8SMB70CA	P8SMB70A	70.0	77.80	89.50	1	1	7.08	113.0
P8SMB75CA	P8SMB75A	75.0	83.3	92.1	1	1	6.61	121.0
P8SMB78CA	P8SMB78A	78.0	86.70	99.70	1	1	6.35	126.0
P8SMB85CA	P8SMB85A	85.0	94.40	108.20	1	1	5.84	137.0
P8SMB90CA	P8SMB90A	90.0	100.0	111.0	1	1	5.48	146.0
P8SMB100CA	P8SMB100A	100.0	110.00	128.00	1	1	4.94	162.0
P8SMB110CA	P8SMB110A	110.0	122.00	140.50	1	1	4.52	177.0
P8SMB120CA	P8SMB120A	120.0	133.00	147.00	1	1	4.15	193.0
P8SMB130CA	P8SMB130A	130.0	144.00	165.50	1	1	3.83	209.0
P8SMB150CA	P8SMB150A	150.0	167.00	192.50	1	1	3.29	243.0
P8SMB160CA	P8SMB160A	160.0	178.00	197.00	1	1	3.09	259.0
P8SMB170CA	P8SMB170A	170.0	189.00	217.50	1	1	2.91	275.0
P8SMB180CA	P8SMB180A	180.0	201.00	222.00	1	1	2.74	292.0
P8SMB200CA	P8SMB200A	200.0	224.00	247.00	1	1	2.47	324.0
P8SMB220CA	P8SMB220A	220.0	246.00	272.00	1	1	2.25	356.0
P8SMB350CA	P8SMB350A	350	391	432	1	1	1.41	567

1.0SMB Series 1000W (DO-214AA)

Part Number (Bi)	Part Number (Uni)	Marking		Reverse Stand off Voltage V_R (Volts)	Breakdown Voltage V_{BR} (Volts)@ I_R		Test Current I_T (mA)	Maximum Reverse Leakage $I_{R@V_R}$ (μ A)	Maximum Peak Pulse Current I_{pp} (A)	Maximum Clamping Voltage $V_C@I_{pp}$ (V)
		BI	UNI		Min .V	Max.V				
1.0SMB6.8CA	1.0SMB6.8A	N10A	A10A	5.8	6.46	7.14	10	900	95.2	10.5
1.0SMB7.5CA	1.0SMB7.5A	N10B	A10B	6.4	7.13	7.88	10	400	88.5	11.3
1.0SMB8.2CA	1.0SMB8.2A	N10C	A10C	7.0	7.79	8.61	10	180	82.6	12.1
1.0SMB9.1CA	1.0SMB9.1A	N10D	A10D	7.8	8.65	9.56	1	45	74.6	13.4
1.0SMB10CA	1.0SMB10A	N10E	A10E	8.6	9.50	10.50	1	8	69.0	14.5
1.0SMB11CA	1.0SMB11A	N10F	A10F	9.4	10.45	11.55	1	4	64.1	15.6
1.0SMB12CA	1.0SMB12A	N10G	A10G	10.2	11.40	12.60	1	1	59.9	16.7
1.0SMB13CA	1.0SMB13A	N10H	A10H	11.1	12.35	13.65	1	1	54.9	18.2
1.0SMB15CA	1.0SMB15A	N10I	A10I	12.8	14.25	15.75	1	1	47.2	21.2
1.0SMB16CA	1.0SMB16A	N10J	A10J	13.6	15.20	16.80	1	1	44.4	22.5
1.0SMB18CA	1.0SMB18A	N10K	A10K	15.3	17.10	18.90	1	1	39.7	25.2
1.0SMB20CA	1.0SMB20A	N10L	A10L	17.1	19.00	21.00	1	1	36.1	27.7
1.0SMB22CA	1.0SMB22A	N10M	A10M	18.8	20.90	23.10	1	1	32.7	30.6
1.0SMB24CA	1.0SMB24A	N10N	A10N	20.5	22.80	25.20	1	1	30.1	33.2
1.0SMB27CA	1.0SMB27A	N10O	A10O	23.1	25.65	28.35	1	1	26.7	37.5
1.0SMB30CA	1.0SMB30A	N10P	A10P	25.6	28.50	31.50	1	1	24.2	41.4
1.0SMB33CA	1.0SMB33A	N10Q	A10Q	28.2	31.35	34.65	1	1	21.9	45.7
1.0SMB36CA	1.0SMB36A	N10R	A10R	30.8	34.20	37.80	1	1	20.0	49.9
1.0SMB39CA	1.0SMB39A	N10S	A10S	33.3	37.05	40.95	1	1	18.6	53.9
1.0SMB43CA	1.0SMB43A	N10T	A10T	36.8	40.85	45.15	1	1	16.9	59.3
1.0SMB47CA	1.0SMB47A	N10U	A10U	40.2	44.65	49.35	1	1	15.4	64.8

PACKAGE OUTLINE DIMENSIONS in inches (millimeters) DO-214AA

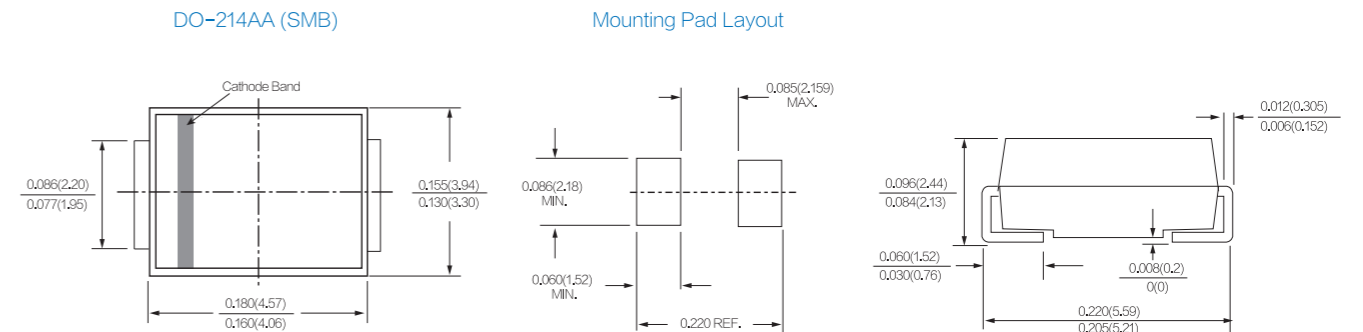

SMCJ Series 1500W(DO-214AB)



Part Number (Bi)	Part Number (Uni)	Marking		Reverse Stand off Voltage V_R (Volts)	Breakdown Voltage V_{BR} (Volts)@ I_R		Test Current I_R (mA)	Maximum Reverse Leakage $I_{R@V_R}$ (μ A)	Maximum Peak Pulse Current I_{pp} (A)	Maximum Clamping Voltage $V_C@I_{pp}$ (V)
		BI	UNI		Min .V	Max.V				
SMCJ5.0CA	SMCJ5.0A	BDE	GDE	5.0	6.40	7.00	10	500	163.0	9.2
SMCJ6.0CA	SMCJ6.0A	BDG	GDG	6.0	6.67	7.37	10	500	145.6	10.3
SMCJ6.5CA	SMCJ6.5A	BDK	GDK	6.5	7.22	7.90	10	300	134.0	11.2
SMCJ7.0CA	SMCJ7.0A	BDM	GDM	7.0	7.78	8.60	10	200	125.0	12.0
SMCJ7.5CA	SMCJ7.5A	BDP	GDP	7.5	8.33	9.21	1	100	116.3	12.9
SMCJ8.0CA	SMCJ8.0A	BDR	GDR	8.0	8.89	9.83	1	50	110.3	13.6
SMCJ8.5CA	SMCJ8.5A	BDT	GDT	8.5	9.44	10.40	1	20	104.2	14.4
SMCJ9.0CA	SMCJ9.0A	BDV	GDV	9.0	10.00	11.10	1	10	97.4	15.4
SMCJ10CA	SMCJ10A	BDX	GDX	10.0	11.10	12.30	1	1	88.3	17.0
SMCJ11CA	SMCJ11A	BDZ	GDZ	11.0	12.20	13.50	1	1	82.5	18.2
SMCJ12CA	SMCJ12A	BEE	GEE	12.0	13.30	14.70	1	1	75.4	19.9
SMCJ13CA	SMCJ13A	BEG	GEG	13.0	14.40	15.90	1	1	69.8	21.5
SMCJ14CA	SMCJ14A	BEK	GEK	14.0	15.60	17.20	1	1	64.7	23.2
SMCJ15CA	SMCJ15A	BEM	GEM	15.0	16.70	18.50	1	1	61.5	24.4
SMCJ16CA	SMCJ16A	BEP	GEP	16.0	17.80	19.70	1	1	57.7	26.0
SMCJ17CA	SMCJ17A	BER	GER	17.0	18.90	20.90	1	1	54.4	27.6
SMCJ18CA	SMCJ18A	BET	GET	18.0	20.00	22.10	1	1	51.4	29.2
SMCJ20CA	SMCJ20A	BEV	GEV	20.0	22.20	24.50	1	1	46.3	32.4
SMCJ22CA	SMCJ22A	BEX	GEX	22.0	24.40	26.90	1	1	42.3	35.5
SMCJ24CA	SMCJ24A	BEZ	GEZ	24.0	26.70	29.50	1	1	38.6	38.9
SMCJ26CA	SMCJ26A	BFE	GFE	26.0	28.90	31.90	1	1	35.7	42.1
SMCJ28CA	SMCJ28A	BFG	GFG	28.0	31.10	34.40	1	1	33.1	45.4
SMCJ30CA	SMCJ30A	BFK	GFK	30.0	33.30	36.80	1	1	31.0	48.4
SMCJ33CA	SMCJ33A	BFM	GFM	33.0	36.70	40.60	1	1	28.2	53.3
SMCJ36CA	SMCJ36A	BFP	GFP	36.0	40.00	44.20	1	1	25.9	58.1
SMCJ40CA	SMCJ40A	BFR	GFR	40.0	44.40	49.10	1	1	23.3	64.5
SMCJ43CA	SMCJ43A	BFT	GFT	43.0	47.80	52.80	1	1	21.7	69.4
SMCJ45CA	SMCJ45A	BFV	GFV	45.0	50.00	55.30	1	1	20.6	72.7

SMCJ Series 1500W(DO-214AB)

Part Number (Bi)	Part Number (Uni)	Marking		Reverse Stand off Voltage V_R (Volts)	Breakdown Voltage V_{BR} (Volts)@ I_R		Test Current I_R (mA)	Maximum Reverse Leakage $I_{R@V_R}$ (μ A)	Maximum Peak Pulse Current I_{pp} (A)	Maximum Clamping Voltage $V_C@I_{pp}$ (V)
		BI	UNI		Min .V	Max.V				
SMCJ48CA	SMCJ48A	BFX	GFX	48.0	53.30	58.90	1	1	19.4	77.4
SMCJ51CA	SMCJ51A	BFZ	GFZ	51.0	56.70	62.70	1	1	18.2	82.4
SMCJ54CA	SMCJ54A	BGE	GGE	54.0	60.00	66.30	1	1	17.3	87.1
SMCJ58CA	SMCJ58A	BGG	GGG	58.0	64.40	71.20	1	1	16.1	93.6
SMCJ60CA	SMCJ60A	BGK	GGK	60.0	66.70	73.70	1	1	15.5	96.8
SMCJ64CA	SMCJ64A	BGM	GGM	64.0	71.10	78.60	1	1	14.6	103.0
SMCJ70CA	SMCJ70A	BGP	GGP	70.0	77.80	86.00	1	1	13.3	113.0
SMCJ75CA	SMCJ75A	BGR	GGR	75.0	83.30	92.10	1	1	12.4	121.0
SMCJ78CA	SMCJ78A	BGT	GGT	78.0	86.70	95.80	1	1	11.9	126.0
SMCJ85CA	SMCJ85A	BGV	GGV	85.0	94.4	104.0	1	1	11.0	137.0
SMCJ90CA	SMCJ90A	BGX	GGX	90.0	100.0	111.0	1	1	10.3	146.0
SMCJ100CA	SMCJ100A	BGZ	GGZ	100.0	111.0	123.0	1	1	9.3	162.0
SMCJ110CA	SMCJ110A	BHE	GHE	110.0	122.0	135.0	1	1	8.5	177.0
SMCJ120CA	SMCJ120A	BHG	GHG	120.0	133.0	147.0	1	1	7.8	193.0
SMCJ130CA	SMCJ130A	BHK	GHK	130.0	144.0	159.0	1	1	7.2	209.0
SMCJ150CA	SMCJ150A	BHM	GHM	150.0	167.0	185.0	1	1	6.2	243.0
SMCJ160CA	SMCJ160A	BHP	GHP	160.0	178.0	197.0	1	1	5.8	259.0
SMCJ170CA	SMCJ170A	BHR	GHR	170.0	189.0	209.0	1	1	5.5	275.0
SMCJ180CA	SMCJ180A	BHT	GHT	180.0	201.0	222.0	1	1	5.1	292.0
SMCJ190CA	SMCJ190A	BHU	GHU	190.0	211.0	233.0	1	1	4.8	308.0
SMCJ200CA	SMCJ200A	BHV	GHV	200.0	224.0	247.0	1	1	4.6	324.0
SMCJ210CA	SMCJ210A	BHW	GHW	210.0	237.0	263.0	1	1	4.4	340.0
SMCJ220CA	SMCJ220A	BHX	GHX	220.0	246.0	272.0	1	1	4.2	356.0
SMCJ250CA	SMCJ250A	BHZ	GHZ	250.0	279.0	309.0	1	1	3.7	405.0
SMCJ300CA	SMCJ300A	BJE	GJE	300.0	335.0	371.0	1	1	3.1	486.0
SMCJ350CA	SMCJ350A	BJG	GJG	350.0	391.0	432.0	1	1	2.6	567.0
SMCJ400CA	SMCJ400A	BJK	GJK	400.0	447.0	494.0	1	1	2.3	648.0
SMCJ440CA	SMCJ440A	BJM	GJM	440.0	492.0	543.0	1	1	2.1	713.0

SMCJ Series 1500W(DO-214AB)



Part Number (Bi)	Part Number (Uni)	Marking		Reverse Stand off Voltage V_R (Volts)	Breakdown Voltage V_{BR} (Volts)@ I_T		Test Current I_T (mA)	Maximum Reverse Leakage $I_{R@V_R}$ (μ A)	Maximum Peak Pulse Current I_{pp} (A)	Maximum Clamping Voltage $V_C@I_{pp}$ (V)
		BI	UNI		Min .V	Max.V				
SMCJ5.0CA	SMCJ5.0A	BDE	GDE	5.0	6.40	7.00	10	500	163.0	9.2
SMCJ6.0CA	SMCJ6.0A	BDG	GDG	6.0	6.67	7.37	10	500	145.6	10.3
SMCJ6.5CA	SMCJ6.5A	BDK	GDK	6.5	7.22	7.90	10	300	134.0	11.2
SMCJ7.0CA	SMCJ7.0A	BDM	GDM	7.0	7.78	8.60	10	200	125.0	12.0
SMCJ7.5CA	SMCJ7.5A	BDP	GDP	7.5	8.33	9.21	1	100	116.3	12.9
SMCJ8.0CA	SMCJ8.0A	BDR	GDR	8.0	8.89	9.83	1	50	110.3	13.6
SMCJ8.5CA	SMCJ8.5A	BDT	GDT	8.5	9.44	10.40	1	20	104.2	14.4
SMCJ9.0CA	SMCJ9.0A	BDV	GDV	9.0	10.00	11.10	1	10	97.4	15.4
SMCJ10CA	SMCJ10A	BDX	GDX	10.0	11.10	12.30	1	1	88.3	17.0
SMCJ11CA	SMCJ11A	BDZ	GDZ	11.0	12.20	13.50	1	1	82.5	18.2
SMCJ12CA	SMCJ12A	BEE	GEE	12.0	13.30	14.70	1	1	75.4	19.9
SMCJ13CA	SMCJ13A	BEG	GEG	13.0	14.40	15.90	1	1	69.8	21.5
SMCJ14CA	SMCJ14A	BEK	GEK	14.0	15.60	17.20	1	1	64.7	23.2
SMCJ15CA	SMCJ15A	BEM	GEM	15.0	16.70	18.50	1	1	61.5	24.4
SMCJ16CA	SMCJ16A	BEP	GEP	16.0	17.80	19.70	1	1	57.7	26.0
SMCJ17CA	SMCJ17A	BER	GER	17.0	18.90	20.90	1	1	54.4	27.6
SMCJ18CA	SMCJ18A	BET	GET	18.0	20.00	22.10	1	1	51.4	29.2
SMCJ20CA	SMCJ20A	BEV	GEV	20.0	22.20	24.50	1	1	46.3	32.4
SMCJ22CA	SMCJ22A	BEX	GEX	22.0	24.40	26.90	1	1	42.3	35.5
SMCJ24CA	SMCJ24A	BEZ	GEZ	24.0	26.70	29.50	1	1	38.6	38.9
SMCJ26CA	SMCJ26A	BFE	GFE	26.0	28.90	31.90	1	1	35.7	42.1
SMCJ28CA	SMCJ28A	BFG	GFG	28.0	31.10	34.40	1	1	33.1	45.4
SMCJ30CA	SMCJ30A	BFK	GFK	30.0	33.30	36.80	1	1	31.0	48.4
SMCJ33CA	SMCJ33A	BFM	GFM	33.0	36.70	40.60	1	1	28.2	53.3
SMCJ36CA	SMCJ36A	BFP	GFP	36.0	40.00	44.20	1	1	25.9	58.1
SMCJ40CA	SMCJ40A	BFR	GFR	40.0	44.40	49.10	1	1	23.3	64.5
SMCJ43CA	SMCJ43A	BFT	GFT	43.0	47.80	52.80	1	1	21.7	69.4
SMCJ45CA	SMCJ45A	BFV	GFV	45.0	50.00	55.30	1	1	20.6	72.7

SMCJ Series 1500W(DO-214AB)

Part Number (Bi)	Part Number (Uni)	Marking		Reverse Stand off Voltage V_R (Volts)	Breakdown Voltage V_{BR} (Volts)@ I_T		Test Current I_T (mA)	Maximum Reverse Leakage $I_{R@V_R}$ (μ A)	Maximum Peak Pulse Current I_{pp} (A)	Maximum Clamping Voltage $V_C@I_{pp}$ (V)
		BI	UNI		Min .V	Max.V				
SMCJ48CA	SMCJ48A	BFX	GFX	48.0	53.30	58.90	1	1	19.4	77.4
SMCJ51CA	SMCJ51A	BFZ	GFZ	51.0	56.70	62.70	1	1	18.2	82.4
SMCJ54CA	SMCJ54A	BGE	GGE	54.0	60.00	66.30	1	1	17.3	87.1
SMCJ58CA	SMCJ58A	BGG	GGG	58.0	64.40	71.20	1	1	16.1	93.6
SMCJ60CA	SMCJ60A	BGK	GGK	60.0	66.70	73.70	1	1	15.5	96.8
SMCJ64CA	SMCJ64A	BGM	GGM	64.0	71.10	78.60	1	1	14.6	103.0
SMCJ70CA	SMCJ70A	BGP	GGP	70.0	77.80	86.00	1	1	13.3	113.0
SMCJ75CA	SMCJ75A	BGR	GGR	75.0	83.30	92.10	1	1	12.4	121.0
SMCJ78CA	SMCJ78A	BGT	GGT	78.0	86.70	95.80	1	1	11.9	126.0
SMCJ85CA	SMCJ85A	BGV	GGV	85.0	94.4	104.0	1	1	11.0	137.0
SMCJ90CA	SMCJ90A	BGX	GGX	90.0	100.0	111.0	1	1	10.3	146.0
SMCJ100CA	SMCJ100A	BGZ	GGZ	100.0	111.0	123.0	1	1	9.3	162.0
SMCJ110CA	SMCJ110A	BHE	GHE	110.0	122.0	135.0	1	1	8.5	177.0
SMCJ120CA	SMCJ120A	BHG	GHG	120.0	133.0	147.0	1	1	7.8	193.0
SMCJ130CA	SMCJ130A	BHK	GHK	130.0	144.0	159.0	1	1	7.2	209.0
SMCJ150CA	SMCJ150A	BHM	GHM	150.0	167.0	185.0	1	1	6.2	243.0
SMCJ160CA	SMCJ160A	BHP	GHP	160.0	178.0	197.0	1	1	5.8	259.0
SMCJ170CA	SMCJ170A	BHR	GHR	170.0	189.0	209.0	1	1	5.5	275.0
SMCJ180CA	SMCJ180A	BHT	GHT	180.0	201.0	222.0	1	1	5.1	292.0
SMCJ190CA	SMCJ190A	BHU	GHU	190.0	211.0	233.0	1	1	4.8	308.0
SMCJ200CA	SMCJ200A	BHV	GHV	200.0	224.0	247.0	1	1	4.6	324.0
SMCJ210CA	SMCJ210A	BHW	GHW	210.0	237.0	263.0	1	1	4.4	340.0
SMCJ220CA	SMCJ220A	BHX	GHX	220.0	246.0	272.0	1	1	4.2	356.0
SMCJ250CA	SMCJ250A	BHZ	GHZ	250.0	279.0	309.0	1	1	3.7	405.0
SMCJ300CA	SMCJ300A	BJE	GJE	300.0	335.0	371.0	1	1	3.1	486.0
SMCJ350CA	SMCJ350A	BJG	GJG	350.0	391.0	432.0	1	1	2.6	567.0
SMCJ400CA	SMCJ400A	BJK	GJK	400.0	447.0	494.0	1	1	2.3	648.0
SMCJ440CA	SMCJ440A	BJM	GJM	440.0	492.0	543.0	1	1	2.1	713.0

SMDJ Series 3000W(DO-214AB)



Part Number (Bi)	Part Number (Uni)	Marking		Reverse Stand off Voltage V_R (Volts)	Breakdown Voltage V_{BR} (Volts)@ I_T		Test Current I_T (mA)	Maximum Reverse Leakage $I_{R@V_R}$ (μ A)	Maximum Peak Pulse Current I_{pp} (A)	Maximum Clamping Voltage $V_C@I_{pp}$ (V)
		BI	UNI		Min .V	Max.V				
SMDJ5.0CA	SMDJ5.0A	DDE	RDE	5.0	6.40	7.00	10	800	326.1	9.2
SMDJ6.0CA	SMDJ6.0A	DDG	RDG	6.0	6.67	7.37	10	800	291.3	10.3
SMDJ6.5CA	SMDJ6.5A	DDK	RDK	6.5	7.22	7.98	10	500	267.9	11.2
SMDJ7.0CA	SMDJ7.0A	DDM	PDM	7.0	7.78	8.60	10	200	250.0	12.0
SMDJ7.5CA	SMDJ7.5A	DDP	PDP	7.5	8.33	9.21	1	100	232.6	12.9
SMDJ8.0CA	SMDJ8.0A	DDR	PDR	8.0	8.89	9.83	1	50	220.6	13.6
SMDJ8.5CA	SMDJ8.5A	DDT	PDT	8.5	9.44	10.40	1	20	208.3	14.4
SMDJ9.0CA	SMDJ9.0A	DDV	PDV	9.0	10.00	11.10	1	10	194.8	15.4
SMDJ10CA	SMDJ10A	DDX	PDX	10.0	11.10	12.30	1	5	176.5	17.0
SMDJ11CA	SMDJ11A	DDZ	PDZ	11.0	12.20	13.50	1	2	164.8	18.2
SMDJ12CA	SMDJ12A	DEE	PEE	12.0	13.30	14.70	1	2	150.8	19.9
SMDJ13CA	SMDJ13A	DEG	PEG	13.0	14.40	15.90	1	2	139.5	21.5
SMDJ14CA	SMDJ14A	DEK	PEK	14.0	15.60	17.20	1	2	129.3	23.2
SMDJ15CA	SMDJ15A	DEM	PEM	15.0	16.70	18.50	1	2	123.0	24.4
SMDJ16CA	SMDJ16A	DEP	PEP	16.0	17.80	19.70	1	2	115.4	26.0
SMDJ17CA	SMDJ17A	DER	PER	17.0	18.90	20.90	1	2	108.7	27.6
SMDJ18CA	SMDJ18A	DET	PET	18.0	20.00	22.10	1	2	102.7	29.2
SMDJ20CA	SMDJ20A	DEV	PEV	20.0	22.20	24.50	1	2	92.6	32.4
SMDJ22CA	SMDJ22A	DEX	PEX	22.0	24.40	26.90	1	2	84.5	35.5
SMDJ24CA	SMDJ24A	DEZ	PEZ	24.0	26.70	29.50	1	2	77.1	38.9
SMDJ26CA	SMDJ26A	DFE	PFE	26.0	28.90	31.90	1	2	71.3	42.1
SMDJ28CA	SMDJ28A	DFG	PFG	28.0	31.10	34.40	1	2	66.1	45.4
SMDJ30CA	SMDJ30A	DFK	PFK	30.0	33.30	36.80	1	2	62.0	48.4
SMDJ33CA	SMDJ33A	DFM	PFM	33.0	36.70	40.60	1	2	56.3	53.3
SMDJ36CA	SMDJ36A	DFP	PFM	36.0	40.00	44.20	1	2	51.6	58.1
SMDJ40CA	SMDJ40A	DFR	PFR	40.0	44.40	49.10	1	2	46.5	64.5

SMDJ Series 3000W(DO-214AB)

Part Number (Bi)	Part Number (Uni)	Marking		Reverse Stand off Voltage V_R (Volts)	Breakdown Voltage V_{BR} (Volts)@ I_T		Test Current I_T (mA)	Maximum Reverse Leakage $I_{R@V_R}$ (μ A)	Maximum Peak Pulse Current I_{pp} (A)	Maximum Clamping Voltage $V_C@I_{pp}$ (V)
		BI	UNI		Min .V	Max.V				
SMDJ43CA	SMDJ43A	DFT	PFT	43.0	47.80	52.80	1	2	43.2	69.4
SMDJ45CA	SMDJ45A	DFV	PFV	45.0	50.00	55.30	1	2	41.3	72.7
SMDJ48CA	SMDJ48A	DFX	PFX	48.0	53.30	58.90	1	2	38.8	77.4
SMDJ51CA	SMDJ51A	DFZ	PFZ	51.0	56.70	62.70	1	2	36.4	82.4
SMDJ54CA	SMDJ54A	DGE	RGE	54.0	60.00	66.30	1	2	34.4	87.1
SMDJ58CA	SMDJ58A	DGG	PGG	58.0	64.40	71.20	1	2	32.1	93.6
SMDJ60CA	SMDJ60A	DGK	PGK	60.0	66.70	73.70	1	2	31.0	96.8
SMDJ64CA	SMDJ64A	DGM	PGM	64.0	71.10	78.60	1	2	29.1	103.0
SMDJ70CA	SMDJ70A	DGP	PGP	70.0	77.80	86.00	1	2	26.5	113.0
SMDJ75CA	SMDJ75A	DGR	PGR	75.0	83.30	92.10	1	2	24.8	121.0
SMDJ78CA	SMDJ78A	DGT	PGT	78.0	86.70	95.80	1	2	23.8	126.0
SMDJ85CA	SMDJ85A	DGV	PGV	85.0	94.40	104.0	1	2	21.9	137.0
SMDJ90CA	SMDJ90A	DGX	PGX	90.0	100.0	111.0	1	2	20.5	146.0
SMDJ100CA	SMDJ100A	DGZ	PGZ	100.0	111.0	123.0	1	2	18.5	162.0
SMDJ110CA	SMDJ110A	DHE	PHE	110.0	122.0	135.0	1	2	16.9	177.0
SMDJ120CA	SMDJ120A	DHG	PHG	120.0	133.0	147.0	1	2	15.5	193.0
SMDJ130CA	SMDJ130A	DHK	PHK	130.0	144.0	159.0	1	2	14.4	209.0
SMDJ150CA	SMDJ150A	DHM	PHM	150.0	167.0	185.0	1	2	12.3	243.0
SMDJ160CA	SMDJ160A	DHP	PHP	160.0	178.0	197.0	1	2	11.6	259.0
SMDJ170CA	SMDJ170A	DHR	PHR	170.0	189.0	209.0	1	2	10.9	275.0
SMDJ180CA	SMDJ180A	IHT	HHT	180.0	201.0	222.0	1	2	10.3	292.0
SMDJ190CA	SMDJ190A	IHV	HHV	190.0	211.0	233.0	1	2	9.7	308.0
SMDJ200CA	SMDJ200A	IHX	HHX	200.0	224.0	247.0	1	2	9.3	324.0
SMDJ210CA	SMDJ210A	IHZ	HHZ	210.0	237.0	263.0	1	2	8.8	340.0
SMDJ220CA	SMDJ220A	III	HIE	220.0	246.0	272.0	1	2	8.4	356.0

SMDJ Series 3000W(DO-214AB)



Part Number (Bi)	Part Number (Uni)	Marking		Reverse Stand off Voltage V_R (Volts)	Breakdown Voltage V_{BR} (Volts)@ I_R		Test Current I_T (mA)	Maximum Reverse Leakage $I_R @ V_R$ (μA)	Maximum Peak Pulse Current I_{pp} (A)	Maximum Clamping Voltage $V_C @ I_{pp}$ (V)
		BI	UNI		Min .V	Max.V				
SMDJ5.0CA	SMDJ5.0A	DDE	RDE	5.0	6.40	7.00	10	800	326.1	9.2
SMDJ6.0CA	SMDJ6.0A	DDG	RDG	6.0	6.67	7.37	10	800	291.3	10.3
SMDJ6.5CA	SMDJ6.5A	DDK	RDK	6.5	7.22	7.98	10	500	267.9	11.2
SMDJ7.0CA	SMDJ7.0A	DDM	PDM	7.0	7.78	8.60	10	200	250.0	12.0
SMDJ7.5CA	SMDJ7.5A	DDP	PDP	7.5	8.33	9.21	1	100	232.6	12.9
SMDJ8.0CA	SMDJ8.0A	DDR	PDR	8.0	8.89	9.83	1	50	220.6	13.6
SMDJ8.5CA	SMDJ8.5A	DDT	PDT	8.5	9.44	10.40	1	20	208.3	14.4
SMDJ9.0CA	SMDJ9.0A	DDV	PDV	9.0	10.00	11.10	1	10	194.8	15.4
SMDJ10CA	SMDJ10A	DDX	PDX	10.0	11.10	12.30	1	5	176.5	17.0
SMDJ11CA	SMDJ11A	DDZ	PDZ	11.0	12.20	13.50	1	2	164.8	18.2
SMDJ12CA	SMDJ12A	DEE	PEE	12.0	13.30	14.70	1	2	150.8	19.9
SMDJ13CA	SMDJ13A	DEG	PEG	13.0	14.40	15.90	1	2	139.5	21.5
SMDJ14CA	SMDJ14A	DEK	PEK	14.0	15.60	17.20	1	2	129.3	23.2
SMDJ15CA	SMDJ15A	DEM	PEM	15.0	16.70	18.50	1	2	123.0	24.4
SMDJ16CA	SMDJ16A	DEP	PEP	16.0	17.80	19.70	1	2	115.4	26.0
SMDJ17CA	SMDJ17A	DER	PER	17.0	18.90	20.90	1	2	108.7	27.6
SMDJ18CA	SMDJ18A	DET	PET	18.0	20.00	22.10	1	2	102.7	29.2
SMDJ20CA	SMDJ20A	DEV	PEV	20.0	22.20	24.50	1	2	92.6	32.4
SMDJ22CA	SMDJ22A	DEX	PEX	22.0	24.40	26.90	1	2	84.5	35.5
SMDJ24CA	SMDJ24A	DEZ	PEZ	24.0	26.70	29.50	1	2	77.1	38.9
SMDJ26CA	SMDJ26A	DFE	PFE	26.0	28.90	31.90	1	2	71.3	42.1
SMDJ28CA	SMDJ28A	DFG	PFG	28.0	31.10	34.40	1	2	66.1	45.4
SMDJ30CA	SMDJ30A	DFK	PFK	30.0	33.30	36.80	1	2	62.0	48.4
SMDJ33CA	SMDJ33A	DFM	PFM	33.0	36.70	40.60	1	2	56.3	53.3
SMDJ36CA	SMDJ36A	DFP	PFM	36.0	40.00	44.20	1	2	51.6	58.1
SMDJ40CA	SMDJ40A	DFR	PFR	40.0	44.40	49.10	1	2	46.5	64.5

SMDJ Series 3000W(DO-214AB)

Part Number (Bi)	Part Number (Uni)	Marking		Reverse Stand off Voltage V_R (Volts)	Breakdown Voltage V_{BR} (Volts)@ I_R		Test Current I_T (mA)	Maximum Reverse Leakage $I_R @ V_R$ (μA)	Maximum Peak Pulse Current I_{pp} (A)	Maximum Clamping Voltage $V_C @ I_{pp}$ (V)
		BI	UNI		Min .V	Max.V				
SMDJ43CA	SMDJ43A	DFT	PFT	43.0	47.80	52.80	1	2	43.2	69.4
SMDJ45CA	SMDJ45A	DFV	PFV	45.0	50.00	55.30	1	2	41.3	72.7
SMDJ48CA	SMDJ48A	DFX	PFV	48.0	53.30	58.90	1	2	38.8	77.4
SMDJ51CA	SMDJ51A	DFZ	PFZ	51.0	56.70	62.70	1	2	36.4	82.4
SMDJ54CA	SMDJ54A	DGE	RGE	54.0	60.00	66.30	1	2	34.4	87.1
SMDJ58CA	SMDJ58A	DGG	PGG	58.0	64.40	71.20	1	2	32.1	93.6
SMDJ60CA	SMDJ60A	DGK	PGK	60.0	66.70	73.70	1	2	31.0	96.8
SMDJ64CA	SMDJ64A	DGM	PGM	64.0	71.10	78.60	1	2	29.1	103.0
SMDJ70CA	SMDJ70A	DGP	PGP	70.0	77.80	86.00	1	2	26.5	113.0
SMDJ75CA	SMDJ75A	DGR	PGR	75.0	83.30	92.10	1	2	24.8	121.0
SMDJ78CA	SMDJ78A	DGT	PGT	78.0	86.70	95.80	1	2	23.8	126.0
SMDJ85CA	SMDJ85A	DGV	PGV	85.0	94.40	104.0	1	2	21.9	137.0
SMDJ90CA	SMDJ90A	DGX	PGX	90.0	100.0	111.0	1	2	20.5	146.0
SMDJ100CA	SMDJ100A	DGZ	PGZ	100.0	111.0	123.0	1	2	18.5	162.0
SMDJ110CA	SMDJ110A	DHE	PHE	110.0	122.0	135.0	1	2	16.9	177.0
SMDJ120CA	SMDJ120A	DHG	PHG	120.0	133.0	147.0	1	2	15.5	193.0
SMDJ130CA	SMDJ130A	DHK	PHK	130.0	144.0	159.0	1	2	14.4	209.0
SMDJ150CA	SMDJ150A	DHM	PHM	150.0	167.0	185.0	1	2	12.3	243.0
SMDJ160CA	SMDJ160A	DHP	PHP	160.0	178.0	197.0	1	2	11.6	259.0
SMDJ170CA	SMDJ170A	DHR	PHR	170.0	189.0	209.0	1	2	10.9	275.0
SMDJ180CA	SMDJ180A	IHT	HHT	180.0	201.0	222.0	1	2	10.3	292.0
SMDJ190CA	SMDJ190A	IHV	HHV	190.0	211.0	233.0	1	2	9.7	308.0
SMDJ200CA	SMDJ200A	IHX	HHX	200.0	224.0	247.0	1	2	9.3	324.0
SMDJ210CA	SMDJ210A	IHZ	HHZ	210.0	237.0	263.0	1	2	8.8	340.0
SMDJ220CA	SMDJ220A	III	HIE	220.0	246.0	272.0	1	2	8.4	356.0

5.0SMDJ Series 5000W(DO-214AB)



Part Number (Bi)	Part Number (Uni)	Marking		Reverse Stand off Voltage V_R (Volts)	Breakdown Voltage V_{BR} (Volts)@I _r		Test Current I _r (mA)	Maximum Reverse Leakage I _R @ V_R (μ A)	Maximum Peak Pulse Current I _{pp} (A)	Maximum Clamping Voltage V_C @I _{pp} (V)
		BI	UNI		Min .V	Max.V				
5.0SMDJ11CA	5.0SMDJ11A	5BEN	5PEN	11.0	12.20	13.50	10	800	275.00	18.2
5.0SMDJ12CA	5.0SMDJ12A	5BEP	5PEP	12.0	13.30	14.70	10	800	252.00	19.9
5.0SMDJ13CA	5.0SMDJ13A	5BEQ	5PEQ	13.0	14.40	15.90	10	500	233.00	21.5
5.0SMDJ14CA	5.0SMDJ14A	5BER	5PER	14.0	15.60	17.20	10	200	216.00	23.2
5.0SMDJ15CA	5.0SMDJ15A	5BES	5PES	15.0	16.70	18.50	1	100	205.00	24.4
5.0SMDJ16CA	5.0SMDJ16A	5BET	5PET	16.0	17.80	19.70	1	50	193.00	26.0
5.0SMDJ17CA	5.0SMDJ17A	5BEU	5PEU	17.0	18.90	20.90	1	20	181.00	27.6
5.0SMDJ18CA	5.0SMDJ18A	5BEV	5PEV	18.0	20.00	22.10	1	10	172.00	29.2
5.0SMDJ20CA	5.0SMDJ20A	5BEW	5PEW	20.0	22.20	24.50	1	2	155.00	32.4
5.0SMDJ22CA	5.0SMDJ22A	5BEX	5PEX	22.0	24.40	26.90	1	2	141.00	35.5
5.0SMDJ24CA	5.0SMDJ24A	5BEZ	5PEZ	24.0	26.70	29.50	1	2	129.00	38.9
5.0SMDJ26CA	5.0SMDJ26A	5BFE	5PFE	26.0	28.90	31.90	1	2	119.00	42.1
5.0SMDJ28CA	5.0SMDJ28A	5BFG	5PFG	28.0	31.10	34.40	1	2	110.00	45.4
5.0SMDJ30CA	5.0SMDJ30A	5BFK	5PFK	30.0	33.30	36.80	1	2	103.00	48.4
5.0SMDJ33CA	5.0SMDJ33A	5BFM	5PFM	33.0	36.70	40.60	1	2	93.90	53.3
5.0SMDJ36CA	5.0SMDJ36A	5BFP	5PFP	36.0	40.00	44.20	1	2	86.10	58.1
5.0SMDJ40CA	5.0SMDJ40A	5BFR	5PFR	40.0	44.40	49.10	1	2	77.60	64.5
5.0SMDJ43CA	5.0SMDJ43A	5BFT	5PFT	43.0	47.80	52.80	1	2	72.10	69.4
5.0SMDJ45CA	5.0SMDJ45A	5BFV	5PFV	45.0	50.00	55.30	1	2	68.80	72.7
5.0SMDJ48CA	5.0SMDJ48A	5BFX	5PFX	48.0	53.30	58.90	1	2	64.70	77.4
5.0SMDJ51CA	5.0SMDJ51A	5BFZ	5PFZ	51.0	56.70	62.70	1	2	60.70	82.4
5.0SMDJ54CA	5.0SMDJ54A	5BGE	5PGE	54.0	60.00	66.30	1	2	57.50	87.1
5.0SMDJ58CA	5.0SMDJ58A	5BGG	5PGG	58.0	64.40	71.20	1	2	53.50	93.6
5.0SMDJ60CA	5.0SMDJ60A	5B GK	5PGK	60.0	66.70	73.70	1	2	51.70	96.8
5.0SMDJ64CA	5.0SMDJ64A	5BGM	5PGM	64.0	71.10	78.60	1	2	48.60	103.0

5.0SMDJ Series 5000W(DO-214AB)

Part Number (Bi)	Part Number (Uni)	Marking		Reverse Stand off Voltage V_R (Volts)	Breakdown Voltage V_{BR} (Volts)@I _r		Test Current I _r (mA)	Maximum Reverse Leakage I _R @ V_R (μ A)	Maximum Peak Pulse Current I _{pp} (A)	Maximum Clamping Voltage V_C @I _{pp} (V)
		BI	UNI		Min .V	Max.V				
5.0SMDJ70CA	5.0SMDJ70A	5BGP	5PGP	70.0	77.80	86.00	1	2	44.30	113.0
5.0SMDJ75CA	5.0SMDJ75A	5BGR	5PGR	75.0	83.30	92.10	1	2	41.40	121.0
5.0SMDJ78CA	5.0SMDJ78A	5BGT	5PGT	78.0	86.70	95.80	1	2	39.70	126.0
5.0SMDJ85CA	5.0SMDJ85A	5BGV	5PGV	85.0	94.40	104.00	1	2	36.50	137.0
5.0SMDJ90CA	5.0SMDJ90A	5BGX	5PGX	90.0	100.00	111.00	1	2	34.30	146.0
5.0SMDJ100CA	5.0SMDJ100A	5BGZ	5PGZ	100.0	111.00	123.00	1	2	30.90	162.0
5.0SMDJ110CA	5.0SMDJ110A	5BHE	5PHE	110.0	122.00	135.00	1	2	28.30	177.0
5.0SMDJ120CA	5.0SMDJ120A	5BHG	5PHG	120.0	133.00	147.00	1	2	26.00	193.0
5.0SMDJ130CA	5.0SMDJ130A	5BHK	5PHK	130.0	144.00	159.00	1	2	24.00	209.0
5.0SMDJ150CA	5.0SMDJ150A	5BHM	5PHM	150.0	167.00	185.00	1	2	20.60	243.0
5.0SMDJ160CA	5.0SMDJ160A	5BHB	5PHP	160.0	178.00	197.00	1	2	19.30	259.0
5.0SMDJ170CA	5.0SMDJ170A	5BHR	5PHR	170.0	189.00	209.00	1	2	18.20	275.0

PACKAGE OUTLINE DIMENSIONS in inches (millimeters) DO-214AB

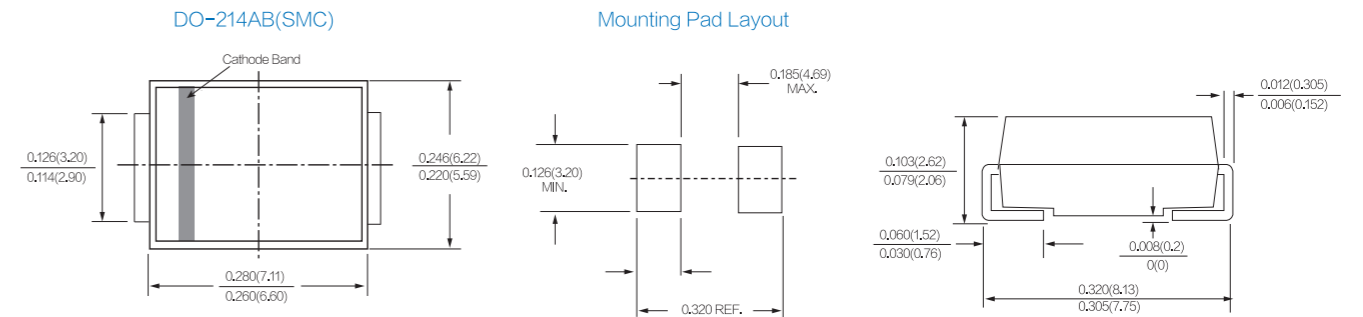

5.0SMDJ Series 5000W(DO-214AB)



Part Number (Bi)	Part Number (Uni)	Marking		Reverse Stand off Voltage V_R (Volts)	Breakdown Voltage V_{BR} (Volts)@ I_R		Test Current I_T (mA)	Maximum Reverse Leakage $I_{R@V_R}$ (μA)	Maximum Peak Pulse Current I_{pp} (A)	Maximum Clamping Voltage $V_C@I_{pp}$ (V)
		BI	UNI		Min .V	Max.V				
5.0SMDJ11CA	5.0SMDJ11A	5BEN	5PEN	11.0	12.20	13.50	10	800	275.00	18.2
5.0SMDJ12CA	5.0SMDJ12A	5BEP	5PEP	12.0	13.30	14.70	10	800	252.00	19.9
5.0SMDJ13CA	5.0SMDJ13A	5BEQ	5PEQ	13.0	14.40	15.90	10	500	233.00	21.5
5.0SMDJ14CA	5.0SMDJ14A	5BER	5PER	14.0	15.60	17.20	10	200	216.00	23.2
5.0SMDJ15CA	5.0SMDJ15A	5BES	5PES	15.0	16.70	18.50	1	100	205.00	24.4
5.0SMDJ16CA	5.0SMDJ16A	5BET	5PET	16.0	17.80	19.70	1	50	193.00	26.0
5.0SMDJ17CA	5.0SMDJ17A	5BEU	5PEU	17.0	18.90	20.90	1	20	181.00	27.6
5.0SMDJ18CA	5.0SMDJ18A	5BEV	5PEV	18.0	20.00	22.10	1	10	172.00	29.2
5.0SMDJ20CA	5.0SMDJ20A	5BEW	5PEW	20.0	22.20	24.50	1	2	155.00	32.4
5.0SMDJ22CA	5.0SMDJ22A	5BEX	5PEX	22.0	24.40	26.90	1	2	141.00	35.5
5.0SMDJ24CA	5.0SMDJ24A	5BEZ	5PEZ	24.0	26.70	29.50	1	2	129.00	38.9
5.0SMDJ26CA	5.0SMDJ26A	5BFE	5PFE	26.0	28.90	31.90	1	2	119.00	42.1
5.0SMDJ28CA	5.0SMDJ28A	5BFG	5PFG	28.0	31.10	34.40	1	2	110.00	45.4
5.0SMDJ30CA	5.0SMDJ30A	5BFK	5PFK	30.0	33.30	36.80	1	2	103.00	48.4
5.0SMDJ33CA	5.0SMDJ33A	5BFM	5PFM	33.0	36.70	40.60	1	2	93.90	53.3
5.0SMDJ36CA	5.0SMDJ36A	5BFP	5PFP	36.0	40.00	44.20	1	2	86.10	58.1
5.0SMDJ40CA	5.0SMDJ40A	5BFR	5PFR	40.0	44.40	49.10	1	2	77.60	64.5
5.0SMDJ43CA	5.0SMDJ43A	5BFT	5PFT	43.0	47.80	52.80	1	2	72.10	69.4
5.0SMDJ45CA	5.0SMDJ45A	5BFV	5PFV	45.0	50.00	55.30	1	2	68.80	72.7
5.0SMDJ48CA	5.0SMDJ48A	5BFX	5PFX	48.0	53.30	58.90	1	2	64.70	77.4
5.0SMDJ51CA	5.0SMDJ51A	5BFZ	5PFZ	51.0	56.70	62.70	1	2	60.70	82.4
5.0SMDJ54CA	5.0SMDJ54A	5BGE	5PGE	54.0	60.00	66.30	1	2	57.50	87.1
5.0SMDJ58CA	5.0SMDJ58A	5BGG	5PGG	58.0	64.40	71.20	1	2	53.50	93.6
5.0SMDJ60CA	5.0SMDJ60A	5B GK	5PGK	60.0	66.70	73.70	1	2	51.70	96.8
5.0SMDJ64CA	5.0SMDJ64A	5BGM	5PGM	64.0	71.10	78.60	1	2	48.60	103.0

5.0SMDJ Series 5000W(DO-214AB)

Part Number (Bi)	Part Number (Uni)	Marking		Reverse Stand off Voltage V_R (Volts)	Breakdown Voltage V_{BR} (Volts)@ I_R		Test Current I_T (mA)	Maximum Reverse Leakage $I_{R@V_R}$ (μA)	Maximum Peak Pulse Current I_{pp} (A)	Maximum Clamping Voltage $V_C@I_{pp}$ (V)
		BI	UNI		Min .V	Max.V				
5.0SMDJ70CA	5.0SMDJ70A	5BGP	5PGP	70.0	77.80	86.00	1	2	44.30	113.0
5.0SMDJ75CA	5.0SMDJ75A	5BGR	5PGR	75.0	83.30	92.10	1	2	41.40	121.0
5.0SMDJ78CA	5.0SMDJ78A	5BGT	5PGT	78.0	86.70	95.80	1	2	39.70	126.0
5.0SMDJ85CA	5.0SMDJ85A	5BGV	5PGV	85.0	94.40	104.00	1	2	36.50	137.0
5.0SMDJ90CA	5.0SMDJ90A	5BGX	5PGX	90.0	100.00	111.00	1	2	34.30	146.0
5.0SMDJ100CA	5.0SMDJ100A	5BGZ	5PGZ	100.0	111.00	123.00	1	2	30.90	162.0
5.0SMDJ110CA	5.0SMDJ110A	5BHE	5PHE	110.0	122.00	135.00	1	2	28.30	177.0
5.0SMDJ120CA	5.0SMDJ120A	5BHG	5PHG	120.0	133.00	147.00	1	2	26.00	193.0
5.0SMDJ130CA	5.0SMDJ130A	5BHK	5PHK	130.0	144.00	159.00	1	2	24.00	209.0
5.0SMDJ150CA	5.0SMDJ150A	5BHM	5PHM	150.0	167.00	185.00	1	2	20.60	243.0
5.0SMDJ160CA	5.0SMDJ160A	5BHB	5PHP	160.0	178.00	197.00	1	2	19.30	259.0
5.0SMDJ170CA	5.0SMDJ170A	5BHR	5PHR	170.0	189.00	209.00	1	2	18.20	275.0

PACKAGE OUTLINE DIMENSIONS in inches (millimeters) DO-214AB

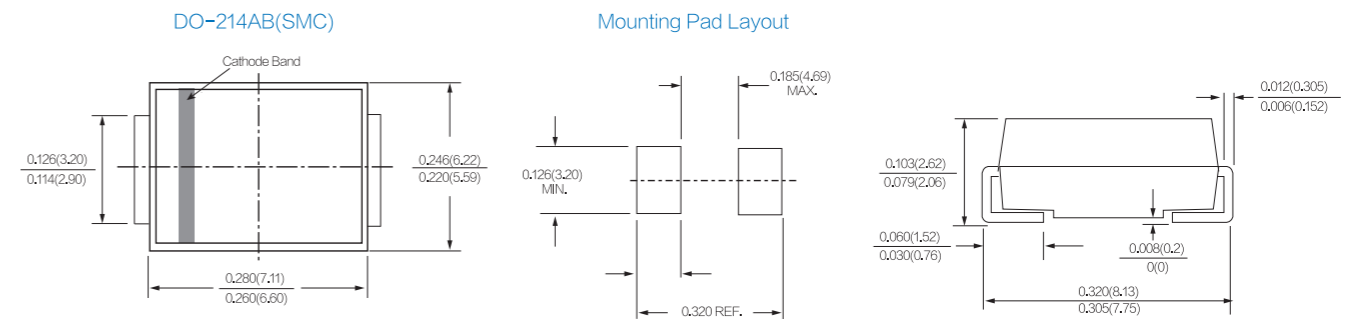

SM8 Series 6600W(DO-218AB)



Part Number (Bi)	Part Number (Uni)	Reverse Stand off Voltage V_R (Volts)	Breakdown Voltage V_{BR} (Volts)@ I_R		Test Current I_R (mA)	Maximum Reverse Leakage $I_{R@V_R}$ (μA)	Maximum I_R @ V_{RWM} $T_J=175$ (μA)	Maximum Peak Pulse Current I_{pp} (A)	Maximum Clamping Voltage V_C @ I_{pp} (V)
			Min .V	Max.V					
SM8S18CA	SM8S18A	18	20.00	22.10	5	10	150	226.0	29.2
SM8S22CA	SM8S22A	22	24.40	26.90	5	10	150	186.0	35.5
SM8S24CA	SM8S24A	24	26.70	29.50	5	10	150	170.0	38.9
SM8S26CA	SM8S26A	26	28.90	31.90	5	10	150	157.0	42.1
SM8S28CA	SM8S28A	28	31.10	34.40	5	10	150	145.0	45.4
SM8S30CA	SM8S30A	30	33.30	36.80	5	10	150	136.0	48.4
SM8S33CA	SM8S33A	33	36.70	40.60	5	10	150	124.0	53.3
SM8S36CA	SM8S36A	36	40.00	44.20	5	10	150	114.0	58.1
SM8S40CA	SM8S40A	40	44.40	49.10	5	10	150	102.0	64.5
SM8S43CA	SM8S43A	43	47.80	52.80	5	10	150	95.1	69.4

PACKAGE OUTLINE DIMENSIONS in millimeters DO-218AB

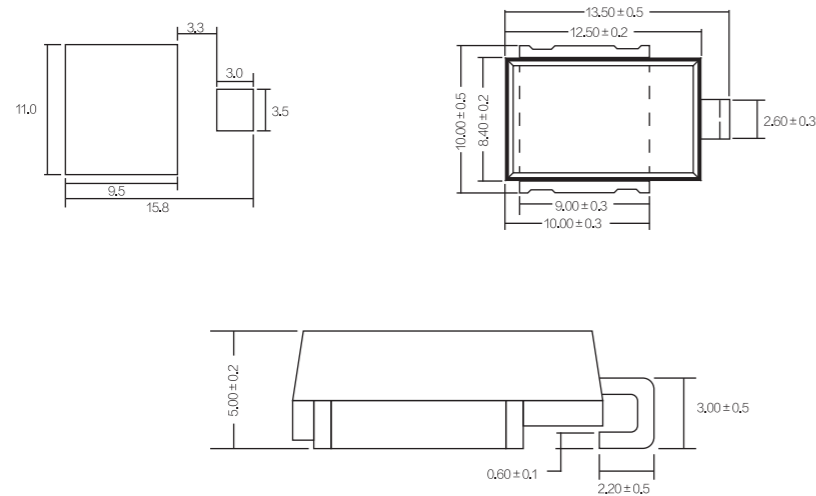

SA Series 500W (DO-15)



Part Number (Bi)	Part Number (Uni)	Reverse Stand off Voltage V_R (Volts)	Breakdown Voltage V_{BR} (Volts)@ I_R		Test Current I_R (mA)	Maximum Reverse Leakage $I_{R@V_R}$ (μA)	Maximum Peak Pulse Current I_{pp} (A)	Maximum Clamping Voltage V_C @ I_{pp} (V)
			Min .V	Max.V				
SA5.0CA	SA5.0A	5.0	6.40	7.00	10	120	55.4	9.2
SA6.0CA	SA6.0A	6.0	6.67	7.37	10	120	49.5	10.3
SA6.5CA	SA6.5A	6.5	7.22	7.90	10	100	45.5	11.2
SA7.0CA	SA7.0A	7.0	7.78	8.60	10	100	42.5	12.0
SA7.5CA	SA7.5A	7.5	8.33	9.21	1	20	39.5	12.9
SA8.0CA	SA8.0A	8.0	8.89	9.83	1	15	37.5	13.6
SA8.5CA	SA8.5A	8.5	9.44	10.40	1	10	35.4	14.4
SA9.0CA	SA9.0A	9.0	10.00	11.10	1	5	33.1	15.4
SA10CA	SA10A	10	11.10	12.30	1	1	30.0	17.0
SA11CA	SA11A	11	12.20	13.50	1	1	28.0	18.2
SA12CA	SA12A	12	13.30	14.70	1	1	25.6	19.9
SA13CA	SA13A	13	14.40	15.90	1	1	23.7	21.5
SA14CA	SA14A	14	15.60	17.20	1	1	22.0	23.2
SA15CA	SA15A	15	16.70	18.50	1	1	20.9	24.4
SA16CA	SA16A	16	17.80	19.70	1	1	19.6	26.0
SA17CA	SA17A	17	18.90	20.90	1	1	18.5	27.6
SA18CA	SA18A	18	20.00	22.10	1	1	17.5	29.2
SA20CA	SA20A	20	22.20	24.50	1	1	15.7	32.4
SA22CA	SA22A	22	24.40	26.90	1	1	14.4	35.5
SA24CA	SA24A	24	26.70	29.50	1	1	13.1	38.9
SA26CA	SA26A	26	28.90	31.90	1	1	12.1	42.1
SA28CA	SA28A	28	31.10	34.40	1	1	11.2	45.4
SA30CA	SA30A	30	33.30	36.80	1	1	10.5	48.4
SA33CA	SA33A	33	36.70	40.60	1	1	9.6	53.3

SM8 Series 6600W(DO-218AB)



Part Number (Bi)	Part Number (Uni)	Reverse Stand off Voltage V_R (Volts)	Breakdown Voltage V_{BR} (Volts)@ I_R		Test Current I_R (mA)	Maximum Reverse Leakage $I_{R@V_R}$ (μA)	Maximum I_R @ V_{RWM} $T_J=175$ (μA)	Maximum Peak Pulse Current I_{pp} (A)	Maximum Clamping Voltage V_C @ I_{pp} (V)
			Min .V	Max.V					
SM8S18CA	SM8S18A	18	20.00	22.10	5	10	150	226.0	29.2
SM8S22CA	SM8S22A	22	24.40	26.90	5	10	150	186.0	35.5
SM8S24CA	SM8S24A	24	26.70	29.50	5	10	150	170.0	38.9
SM8S26CA	SM8S26A	26	28.90	31.90	5	10	150	157.0	42.1
SM8S28CA	SM8S28A	28	31.10	34.40	5	10	150	145.0	45.4
SM8S30CA	SM8S30A	30	33.30	36.80	5	10	150	136.0	48.4
SM8S33CA	SM8S33A	33	36.70	40.60	5	10	150	124.0	53.3
SM8S36CA	SM8S36A	36	40.00	44.20	5	10	150	114.0	58.1
SM8S40CA	SM8S40A	40	44.40	49.10	5	10	150	102.0	64.5
SM8S43CA	SM8S43A	43	47.80	52.80	5	10	150	95.1	69.4

PACKAGE OUTLINE DIMENSIONS in millimeters DO-218AB

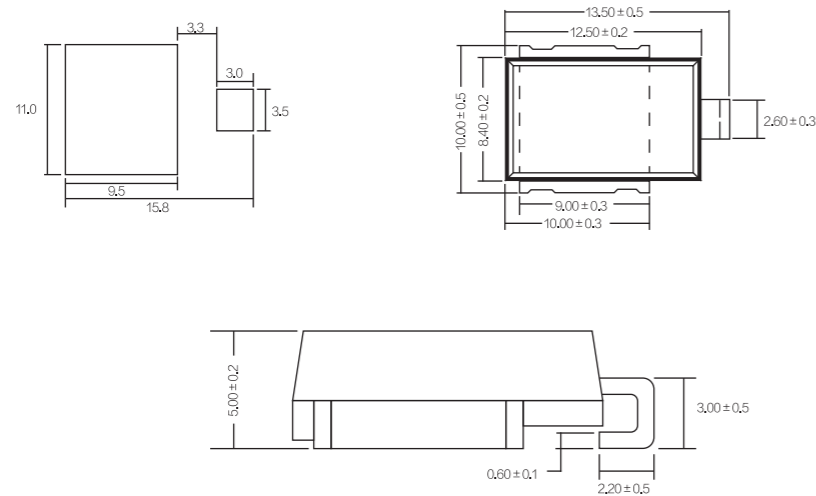

SA Series 500W (DO-15)



Part Number (Bi)	Part Number (Uni)	Reverse Stand off Voltage V_R (Volts)	Breakdown Voltage V_{BR} (Volts)@ I_R		Test Current I_R (mA)	Maximum Reverse Leakage $I_{R@V_R}$ (μA)	Maximum Peak Pulse Current I_{pp} (A)	Maximum Clamping Voltage V_C @ I_{pp} (V)
			Min .V	Max.V				
SA5.0CA	SA5.0A	5.0	6.40	7.00	10	120	55.4	9.2
SA6.0CA	SA6.0A	6.0	6.67	7.37	10	120	49.5	10.3
SA6.5CA	SA6.5A	6.5	7.22	7.90	10	100	45.5	11.2
SA7.0CA	SA7.0A	7.0	7.78	8.60	10	100	42.5	12.0
SA7.5CA	SA7.5A	7.5	8.33	9.21	1	20	39.5	12.9
SA8.0CA	SA8.0A	8.0	8.89	9.83	1	15	37.5	13.6
SA8.5CA	SA8.5A	8.5	9.44	10.40	1	10	35.4	14.4
SA9.0CA	SA9.0A	9.0	10.00	11.10	1	5	33.1	15.4
SA10CA	SA10A	10	11.10	12.30	1	1	30.0	17.0
SA11CA	SA11A	11	12.20	13.50	1	1	28.0	18.2
SA12CA	SA12A	12	13.30	14.70	1	1	25.6	19.9
SA13CA	SA13A	13	14.40	15.90	1	1	23.7	21.5
SA14CA	SA14A	14	15.60	17.20	1	1	22.0	23.2
SA15CA	SA15A	15	16.70	18.50	1	1	20.9	24.4
SA16CA	SA16A	16	17.80	19.70	1	1	19.6	26.0
SA17CA	SA17A	17	18.90	20.90	1	1	18.5	27.6
SA18CA	SA18A	18	20.00	22.10	1	1	17.5	29.2
SA20CA	SA20A	20	22.20	24.50	1	1	15.7	32.4
SA22CA	SA22A	22	24.40	26.90	1	1	14.4	35.5
SA24CA	SA24A	24	26.70	29.50	1	1	13.1	38.9
SA26CA	SA26A	26	28.90	31.90	1	1	12.1	42.1
SA28CA	SA28A	28	31.10	34.40	1	1	11.2	45.4
SA30CA	SA30A	30	33.30	36.80	1	1	10.5	48.4
SA33CA	SA33A	33	36.70	40.60	1	1	9.6	53.3

SA Series 500W (DO-15)

Part Number (Bi)	Part Number (Uni)	Reverse Stand off Voltage V_R (Volts)	Breakdown Voltage V_{BR} (Volts)@I _R		Test Current I _R (mA)	Maximum Reverse Leakage I _R @ V_R (μ A)	Maximum Peak Pulse Current I _{pp} (A)	Maximum Clamping Voltage V_C @I _{pp} (V)
			Min .V	Max.V				
SA36CA	SA36A	36	40.00	44.20	1	1	8.8	58.1
SA40CA	SA40A	40	44.40	49.10	1	1	7.9	64.5
SA43CA	SA43A	43	47.80	52.80	1	1	7.3	69.4
SA45CA	SA45A	45	50.00	55.30	1	1	7.0	72.7
SA48CA	SA48A	48	53.30	58.90	1	1	6.6	77.4
SA51CA	SA51A	51	56.70	62.70	1	1	6.2	82.4
SA54CA	SA54A	54	60.00	66.30	1	1	5.9	87.1
SA58CA	SA58A	58	64.40	71.20	1	1	5.4	93.6
SA60CA	SA60A	60	66.70	73.70	1	1	5.3	96.8
SA64CA	SA64A	64	71.10	78.60	1	1	5.0	103.0
SA70CA	SA70A	70	77.80	86.00	1	1	4.5	113.0
SA75CA	SA75A	75	83.30	92.10	1	1	4.2	121.0
SA78CA	SA78A	78	86.70	95.80	1	1	4.0	126.0
SA85CA	SA85A	85	94.4	104.0	1	1	3.7	137.0
SA90CA	SA90A	90	100.0	111.0	1	1	3.5	146.0
SA100CA	SA100A	100	111.0	123.0	1	1	3.1	162.0
SA110CA	SA110A	110	122.0	135.0	1	1	2.9	177.0
SA120CA	SA120A	120	133.0	147.0	1	1	2.6	193.0
SA130CA	SA130A	130	144.0	159.0	1	1	2.4	209.0
SA150CA	SA150A	150	167.0	185.0	1	1	2.1	243.0
SA160CA	SA160A	160	178.0	197.0	1	1	2.0	259.0
SA170CA	SA170A	170	189.0	209.0	1	1	1.9	275.0
SA180CA	SA180A	180	201.0	222.0	1	1	1.7	292.0
SA190CA	SA190A	190	211.0	233.0	1	1	1.6	308.0

P6KE Series 600W (DO-15)

Part Number (Bi)	Part Number (Uni)	Reverse Stand off Voltage V_R (Volts)	Breakdown Voltage V_{BR} (Volts)@I _R		Test Current I _R (mA)	Maximum Reverse Leakage I _R @ V_R (μ A)	Maximum Peak Pulse Current I _{pp} (A)	Maximum Clamping Voltage V_C @I _{pp} (V)
			Min .V	Max.V				
P6KE6.8CA	P6KE6.8A	5.80	6.45	7.14	10	600	58.1	10.5
P6KE7.5CA	P6KE7.5A	6.40	7.13	7.88	10	400	54.0	11.3
P6KE8.2CA	P6KE8.2A	7.02	7.79	8.61	10	200	50.4	12.1
P6KE9.1CA	P6KE9.1A	7.78	8.65	9.55	1	50	45.5	13.4
P6KE10CA	P6KE10A	8.55	9.50	10.50	1	10	42.1	14.5
P6KE11CA	P6KE11A	9.40	10.50	11.60	1	5	39.1	15.6
P6KE12CA	P6KE12A	10.20	11.40	12.60	1	5	36.5	16.7
P6KE13CA	P6KE13A	11.10	12.40	13.70	1	1	33.5	18.2
P6KE15CA	P6KE15A	12.80	14.30	15.80	1	1	28.8	21.2
P6KE16CA	P6KE16A	13.60	15.20	16.80	1	1	27.1	22.5
P6KE18CA	P6KE18A	15.30	17.10	18.90	1	1	24.2	25.2
P6KE20CA	P6KE20A	17.10	19.00	21.00	1	1	22.0	27.7
P6KE22CA	P6KE22A	18.80	20.90	23.10	1	1	19.9	30.6
P6KE24CA	P6KE24A	20.50	22.80	25.20	1	1	18.4	33.2
P6KE27CA	P6KE27A	23.10	25.70	28.40	1	1	16.3	37.5
P6KE30CA	P6KE30A	25.60	28.50	31.50	1	1	14.7	41.4
P6KE33CA	P6KE33A	28.20	31.40	34.70	1	1	13.3	45.7
P6KE36CA	P6KE36A	30.80	34.20	37.80	1	1	12.2	49.9
P6KE39CA	P6KE39A	33.30	37.10	41.00	1	1	11.3	53.9
P6KE43CA	P6KE43A	36.80	40.90	45.20	1	1	10.3	59.3
P6KE47CA	P6KE47A	40.20	44.70	49.40	1	1	9.4	64.8
P6KE51CA	P6KE51A	43.60	48.5	53.60	1	1	8.7	70.1
P6KE56CA	P6KE56A	47.80	53.20	58.80	1	1	7.9	77.0
P6KE62CA	P6KE62A	53.00	58.90	65.10	1	1	7.2	85.0
P6KE68CA	P6KE68A	58.10	64.60	71.40	1	1	6.6	92.0
P6KE75CA	P6KE75A	64.10	71.30	78.80	1	1	5.9	103.0
P6KE82CA	P6KE82A	70.10	77.90	86.10	1	1	5.4	113.0
P6KE91CA	P6KE91A	77.80	86.50	95.50	1	1	4.9	125.0
P6KE100CA	P6KE100A	85.50	95.00	105.00	1	1	4.5	137.0
P6KE110CA	P6KE110A	94.00	105.00	116.00	1	1	4.0	152.0
P6KE120CA	P6KE120A	102.00	114.00	126.00	1	1	3.7	165.0



TVS

SA Series 500W (DO-15)

Part Number (Bi)	Part Number (Uni)	Reverse Stand off Voltage V_R (Volts)	Breakdown Voltage V_{BR} (Volts)@I _R		Test Current I _R (mA)	Maximum Reverse Leakage I _R @ V_R (μ A)	Maximum Peak Pulse Current I _{pp} (A)	Maximum Clamping Voltage V_C @I _{pp} (V)
			Min .V	Max.V				
SA36CA	SA36A	36	40.00	44.20	1	1	8.8	58.1
SA40CA	SA40A	40	44.40	49.10	1	1	7.9	64.5
SA43CA	SA43A	43	47.80	52.80	1	1	7.3	69.4
SA45CA	SA45A	45	50.00	55.30	1	1	7.0	72.7
SA48CA	SA48A	48	53.30	58.90	1	1	6.6	77.4
SA51CA	SA51A	51	56.70	62.70	1	1	6.2	82.4
SA54CA	SA54A	54	60.00	66.30	1	1	5.9	87.1
SA58CA	SA58A	58	64.40	71.20	1	1	5.4	93.6
SA60CA	SA60A	60	66.70	73.70	1	1	5.3	96.8
SA64CA	SA64A	64	71.10	78.60	1	1	5.0	103.0
SA70CA	SA70A	70	77.80	86.00	1	1	4.5	113.0
SA75CA	SA75A	75	83.30	92.10	1	1	4.2	121.0
SA78CA	SA78A	78	86.70	95.80	1	1	4.0	126.0
SA85CA	SA85A	85	94.4	104.0	1	1	3.7	137.0
SA90CA	SA90A	90	100.0	111.0	1	1	3.5	146.0
SA100CA	SA100A	100	111.0	123.0	1	1	3.1	162.0
SA110CA	SA110A	110	122.0	135.0	1	1	2.9	177.0
SA120CA	SA120A	120	133.0	147.0	1	1	2.6	193.0
SA130CA	SA130A	130	144.0	159.0	1	1	2.4	209.0
SA150CA	SA150A	150	167.0	185.0	1	1	2.1	243.0
SA160CA	SA160A	160	178.0	197.0	1	1	2.0	259.0
SA170CA	SA170A	170	189.0	209.0	1	1	1.9	275.0
SA180CA	SA180A	180	201.0	222.0	1	1	1.7	292.0
SA190CA	SA190A	190	211.0	233.0	1	1	1.6	308.0

P6KE Series 600W (DO-15)

Part Number (Bi)	Part Number (Uni)	Reverse Stand off Voltage V_R (Volts)	Breakdown Voltage V_{BR} (Volts)@I _R		Test Current I _R (mA)	Maximum Reverse Leakage I _R @ V_R (μ A)	Maximum Peak Pulse Current I _{pp} (A)	Maximum Clamping Voltage V_C @I _{pp} (V)
			Min .V	Max.V				
P6KE6.8CA	P6KE6.8A	5.80	6.45	7.14	10	600	58.1	10.5
P6KE7.5CA	P6KE7.5A	6.40	7.13	7.88	10	400	54.0	11.3
P6KE8.2CA	P6KE8.2A	7.02	7.79	8.61	10	200	50.4	12.1
P6KE9.1CA	P6KE9.1A	7.78	8.65	9.55	1	50	45.5	13.4
P6KE10CA	P6KE10A	8.55	9.50	10.50	1	10	42.1	14.5
P6KE11CA	P6KE11A	9.40	10.50	11.60	1	5	39.1	15.6
P6KE12CA	P6KE12A	10.20	11.40	12.60	1	5	36.5	16.7
P6KE13CA	P6KE13A	11.10	12.40	13.70	1	1	33.5	18.2
P6KE15CA	P6KE15A	12.80	14.30	15.80	1	1	28.8	21.2
P6KE16CA	P6KE16A	13.60	15.20	16.80	1	1	27.1	22.5
P6KE18CA	P6KE18A	15.30	17.10	18.90	1	1	24.2	25.2
P6KE20CA	P6KE20A	17.10	19.00	21.00	1	1	22.0	27.7
P6KE22CA	P6KE22A	18.80	20.90	23.10	1	1	19.9	30.6
P6KE24CA	P6KE24A	20.50	22.80	25.20	1	1	18.4	33.2
P6KE27CA	P6KE27A	23.10	25.70	28.40	1	1	16.3	37.5
P6KE30CA	P6KE30A	25.60	28.50	31.50	1	1	14.7	41.4
P6KE33CA	P6KE33A	28.20	31.40	34.70	1	1	13.3	45.7
P6KE36CA	P6KE36A	30.80	34.20	37.80	1	1	12.2	49.9
P6KE39CA	P6KE39A	33.30	37.10	41.00	1	1	11.3	53.9
P6KE43CA	P6KE43A	36.80	40.90	45.20	1	1	10.3	59.3
P6KE47CA	P6KE47A	40.20	44.70	49.40	1	1	9.4	64.8
P6KE51CA	P6KE51A	43.60	48.5	53.60	1	1	8.7	70.1
P6KE56CA	P6KE56A	47.80	53.20	58.80	1	1	7.9	77.0
P6KE62CA	P6KE62A	53.00	58.90	65.10	1	1	7.2	85.0
P6KE68CA	P6KE68A	58.10	64.60	71.40	1	1	6.6	92.0
P6KE75CA	P6KE75A	64.10	71.30	78.80	1	1	5.9	103.0
P6KE82CA	P6KE82A	70.10	77.90	86.10	1	1	5.4	113.0
P6KE91CA	P6KE91A	77.80	86.50	95.50	1	1	4.9	125.0
P6KE100CA	P6KE100A	85.50	95.00	105.00	1	1	4.5	137.0
P6KE110CA	P6KE110A	94.00	105.00	116.00	1	1	4.0	152.0
P6KE120CA	P6KE120A	102.00	114.00	126.00	1	1	3.7	165.0



TVS

P6KE Series 600W (DO-15)

Part Number (Bi)	Part Number (Uni)	Reverse Stand off Voltage V_R (Volts)	Breakdown Voltage V_{BR} (Volts)@ I_R		Test Current I_R (mA)	Maximum Reverse Leakage $I_{R@V_R}$ (μA)	Maximum Peak Pulse Current I_{pp} (A)	Maximum Clamping Voltage $V_C@I_{pp}$ (V)
			Min .V	Max.V				
P6KE130CA	P6KE130A	111.00	124.00	137.00	1	1	3.4	179.0
P6KE150CA	P6KE150A	128.00	143.00	158.00	1	1	2.9	207.0
P6KE160CA	P6KE160A	136.00	152.00	168.00	1	1	2.8	219.0
P6KE170CA	P6KE170A	145.00	162.00	179.00	1	1	2.6	234.0
P6KE180CA	P6KE180A	154.00	171.00	189.00	1	1	2.5	246.0
P6KE200CA	P6KE200A	171.00	190.00	210.00	1	1	2.2	274.0
P6KE220CA	P6KE220A	185.00	209.00	231.00	1	1	1.9	328.0
P6KE250CA	P6KE250A	214.00	237.00	263.00	1	1	1.8	344.0
P6KE300CA	P6KE300A	256.00	285.00	315.00	1	1	1.5	414.0
P6KE350CA	P6KE350A	300.00	332.00	368.00	1	1	1.3	482.0
P6KE400CA	P6KE400A	342.00	380.00	420.00	1	1	1.1	548.0
P6KE440CA	P6KE440A	376.00	418.00	462.00	1	1	1.0	602.0
P6KE480CA	P6KE480A	408.00	456.00	504.00	1	1	0.9	658.0
P6KE510CA	P6KE510A	434.00	485.00	535.00	1	1	0.9	698.0
P6KE530CA	P6KE530A	450.00	503.00	556.00	1	1	0.8	725.0
P6KE540CA	P6KE540A	459.00	513.00	567.00	1	1	0.8	740.0
P6KE550CA	P6KE550A	467.00	522.50	577.50	1	1	0.8	760.0
P6KE600CA	P6KE600A	512.00	570.00	630.00	1	1	0.75	828.0

PACKAGE OUTLINE DIMENSIONS in inches (millimeters) DO-15

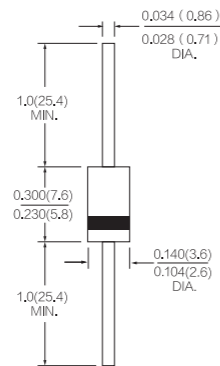

DO-204AC(DO-15)

1.5KE Series 1500W (DO-201)



Part Number (Bi)	Part Number (Uni)	Reverse Stand off Voltage V_R (Volts)	Breakdown Voltage V_{BR} (Volts)@ I_R		Test Current I_R (mA)	Maximum Reverse Leakage $I_{R@V_R}$ (μA)	Maximum Peak Pulse Current I_{pp} (A)	Maximum Clamping Voltage $V_C@I_{pp}$ (V)
			Min .V	Max.V				
1.5KE6.8CA	1.5KE6.8A	5.80	6.45	7.14	10	600	144.8	10.5
1.5KE7.5CA	1.5KE7.5A	6.40	7.13	7.88	10	400	134.5	11.3
1.5KE8.2CA	1.5KE8.2A	7.02	7.79	8.61	10	200	125.6	12.1
1.5KE9.1CA	1.5KE9.1A	7.78	8.65	9.50	1	50	113.4	13.4
1.5KE10CA	1.5KE10A	8.55	9.50	10.50	1	10	104.8	14.5
1.5KE11CA	1.5KE11A	9.40	10.50	11.60	1	5	97.4	15.6
1.5KE12CA	1.5KE12A	10.20	11.40	12.60	1	5	91.0	16.7
1.5KE13CA	1.5KE13A	11.10	12.40	13.70	1	1	83.5	18.2
1.5KE15CA	1.5KE15A	12.80	14.30	15.80	1	1	71.7	21.2
1.5KE16CA	1.5KE16A	13.60	15.20	16.80	1	1	67.6	22.5
1.5KE18CA	1.5KE18A	15.30	17.10	18.90	1	1	60.3	25.2
1.5KE20CA	1.5KE20A	17.10	19.00	21.00	1	1	54.9	27.7
1.5KE22CA	1.5KE22A	18.80	20.90	23.10	1	1	49.7	30.6
1.5KE24CA	1.5KE24A	20.50	22.80	25.20	1	1	45.8	33.2
1.5KE27CA	1.5KE27A	23.10	25.70	28.40	1	1	40.5	37.5
1.5KE30CA	1.5KE30A	25.60	28.50	31.50	1	1	36.7	41.4
1.5KE33CA	1.5KE33A	28.20	31.40	34.70	1	1	33.3	45.7
1.5KE36CA	1.5KE36A	30.80	34.20	37.80	1	1	30.5	49.9
1.5KE39CA	1.5KE39A	33.30	37.10	41.00	1	1	28.2	53.9
1.5KE43CA	1.5KE43A	36.80	40.90	45.20	1	1	25.6	59.3
1.5KE47CA	1.5KE47A	40.20	44.70	49.40	1	1	23.5	64.8
1.5KE51CA	1.5KE51A	43.60	48.50	53.60	1	1	21.7	70.1
1.5KE56CA	1.5KE56A	47.80	53.20	58.80	1	1	19.7	77.0
1.5KE62CA	1.5KE62A	53.00	58.90	65.10	1	1	17.9	85.0
1.5KE68CA	1.5KE68A	58.10	64.60	71.40	1	1	16.5	92.0
1.5KE75CA	1.5KE75A	64.10	71.30	78.80	1	1	14.8	103.0
1.5KE82CA	1.5KE82A	70.10	77.90	86.10	1	1	13.5	113.0
1.5KE91CA	1.5KE91A	77.80	86.50	95.50	1	1	12.2	125.0
1.5KE100CA	1.5KE100A	85.50	95.00	105.00	1	1	11.1	137.0
1.5KE110CA	1.5KE110A	94.00	105.00	116.00	1	1	10.0	152.0
1.5KE120CA	1.5KE120A	102.00	114.00	126.00	1	1	9.2	165.0

P6KE Series 600W (DO-15)

Part Number (Bi)	Part Number (Uni)	Reverse Stand off Voltage V_R (Volts)	Breakdown Voltage V_{BR} (Volts)@ I_R		Test Current I_R (mA)	Maximum Reverse Leakage $I_{R@V_R}$ (μA)	Maximum Peak Pulse Current I_{pp} (A)	Maximum Clamping Voltage $V_C@I_{pp}$ (V)
			Min .V	Max.V				
P6KE130CA	P6KE130A	111.00	124.00	137.00	1	1	3.4	179.0
P6KE150CA	P6KE150A	128.00	143.00	158.00	1	1	2.9	207.0
P6KE160CA	P6KE160A	136.00	152.00	168.00	1	1	2.8	219.0
P6KE170CA	P6KE170A	145.00	162.00	179.00	1	1	2.6	234.0
P6KE180CA	P6KE180A	154.00	171.00	189.00	1	1	2.5	246.0
P6KE200CA	P6KE200A	171.00	190.00	210.00	1	1	2.2	274.0
P6KE220CA	P6KE220A	185.00	209.00	231.00	1	1	1.9	328.0
P6KE250CA	P6KE250A	214.00	237.00	263.00	1	1	1.8	344.0
P6KE300CA	P6KE300A	256.00	285.00	315.00	1	1	1.5	414.0
P6KE350CA	P6KE350A	300.00	332.00	368.00	1	1	1.3	482.0
P6KE400CA	P6KE400A	342.00	380.00	420.00	1	1	1.1	548.0
P6KE440CA	P6KE440A	376.00	418.00	462.00	1	1	1.0	602.0
P6KE480CA	P6KE480A	408.00	456.00	504.00	1	1	0.9	658.0
P6KE510CA	P6KE510A	434.00	485.00	535.00	1	1	0.9	698.0
P6KE530CA	P6KE530A	450.00	503.00	556.00	1	1	0.8	725.0
P6KE540CA	P6KE540A	459.00	513.00	567.00	1	1	0.8	740.0
P6KE550CA	P6KE550A	467.00	522.50	577.50	1	1	0.8	760.0
P6KE600CA	P6KE600A	512.00	570.00	630.00	1	1	0.75	828.0

PACKAGE OUTLINE DIMENSIONS in inches (millimeters) DO-15

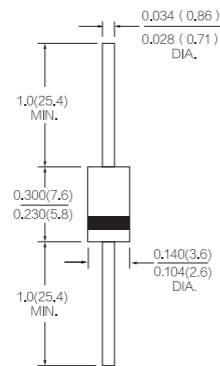

DO-204AC(DO-15)

1.5KE Series 1500W (DO-201)



Part Number (Bi)	Part Number (Uni)	Reverse Stand off Voltage V_R (Volts)	Breakdown Voltage V_{BR} (Volts)@ I_R		Test Current I_R (mA)	Maximum Reverse Leakage $I_{R@V_R}$ (μA)	Maximum Peak Pulse Current I_{pp} (A)	Maximum Clamping Voltage $V_C@I_{pp}$ (V)
			Min .V	Max.V				
1.5KE6.8CA	1.5KE6.8A	5.80	6.45	7.14	10	600	144.8	10.5
1.5KE7.5CA	1.5KE7.5A	6.40	7.13	7.88	10	400	134.5	11.3
1.5KE8.2CA	1.5KE8.2A	7.02	7.79	8.61	10	200	125.6	12.1
1.5KE9.1CA	1.5KE9.1A	7.78	8.65	9.50	1	50	113.4	13.4
1.5KE10CA	1.5KE10A	8.55	9.50	10.50	1	10	104.8	14.5
1.5KE11CA	1.5KE11A	9.40	10.50	11.60	1	5	97.4	15.6
1.5KE12CA	1.5KE12A	10.20	11.40	12.60	1	5	91.0	16.7
1.5KE13CA	1.5KE13A	11.10	12.40	13.70	1	1	83.5	18.2
1.5KE15CA	1.5KE15A	12.80	14.30	15.80	1	1	71.7	21.2
1.5KE16CA	1.5KE16A	13.60	15.20	16.80	1	1	67.6	22.5
1.5KE18CA	1.5KE18A	15.30	17.10	18.90	1	1	60.3	25.2
1.5KE20CA	1.5KE20A	17.10	19.00	21.00	1	1	54.9	27.7
1.5KE22CA	1.5KE22A	18.80	20.90	23.10	1	1	49.7	30.6
1.5KE24CA	1.5KE24A	20.50	22.80	25.20	1	1	45.8	33.2
1.5KE27CA	1.5KE27A	23.10	25.70	28.40	1	1	40.5	37.5
1.5KE30CA	1.5KE30A	25.60	28.50	31.50	1	1	36.7	41.4
1.5KE33CA	1.5KE33A	28.20	31.40	34.70	1	1	33.3	45.7
1.5KE36CA	1.5KE36A	30.80	34.20	37.80	1	1	30.5	49.9
1.5KE39CA	1.5KE39A	33.30	37.10	41.00	1	1	28.2	53.9
1.5KE43CA	1.5KE43A	36.80	40.90	45.20	1	1	25.6	59.3
1.5KE47CA	1.5KE47A	40.20	44.70	49.40	1	1	23.5	64.8
1.5KE51CA	1.5KE51A	43.60	48.50	53.60	1	1	21.7	70.1
1.5KE56CA	1.5KE56A	47.80	53.20	58.80	1	1	19.7	77.0
1.5KE62CA	1.5KE62A	53.00	58.90	65.10	1	1	17.9	85.0
1.5KE68CA	1.5KE68A	58.10	64.60	71.40	1	1	16.5	92.0
1.5KE75CA	1.5KE75A	64.10	71.30	78.80	1	1	14.8	103.0
1.5KE82CA	1.5KE82A	70.10	77.90	86.10	1	1	13.5	113.0
1.5KE91CA	1.5KE91A	77.80	86.50	95.50	1	1	12.2	125.0
1.5KE100CA	1.5KE100A	85.50	95.00	105.00	1	1	11.1	137.0
1.5KE110CA	1.5KE110A	94.00	105.00	116.00	1	1	10.0	152.0
1.5KE120CA	1.5KE120A	102.00	114.00	126.00	1	1	9.2	165.0

1.5KE Series 1500W (DO-201)

Part Number (Bi)	Part Number (Uni)	Reverse Stand off Voltage V_R (Volts)	Breakdown Voltage V_{BR} (Volts)@ I_R		Test Current I_R (mA)	Maximum Reverse Leakage $I_{R@V_R}$ (μA)	Maximum Peak Pulse Current I_{pp} (A)	Maximum Clamping Voltage $V_C@I_{pp}$ (V)
			Min .V	Max.V				
1.5KE130CA	1.5KE130A	111.00	124.00	137.00	1	1	8.5	179.0
1.5KE150CA	1.5KE150A	128.00	143.00	158.00	1	1	7.3	207.0
1.5KE160CA	1.5KE160A	136.00	152.00	168.00	1	1	6.9	219.0
1.5KE170CA	1.5KE170A	145.00	162.00	179.00	1	1	6.5	234.0
1.5KE180CA	1.5KE180A	154.00	171.00	189.00	1	1	6.2	246.0
1.5KE200CA	1.5KE200A	171.00	190.00	210.00	1	1	5.5	274.0
1.5KE220CA	1.5KE220A	185.00	209.00	231.00	1	1	4.6	328.0
1.5KE250CA	1.5KE250A	214.00	237.00	263.00	1	1	4.4	344.0
1.5KE300CA	1.5KE300A	256.00	285.00	315.00	1	1	3.7	414.0
1.5KE350CA	1.5KE350A	300.00	332.00	368.00	1	1	3.2	482.0
1.5KE400CA	1.5KE400A	342.00	380.00	420.00	1	1	2.8	548.0
1.5KE440CA	1.5KE440A	376.00	418.00	462.00	1	1	2.5	602.0
1.5KE480CA	1.5KE480A	408.00	456.00	504.00	1	1	2.3	658.0
1.5KE510CA	1.5KE510A	434.00	485.00	535.00	1	1	2.1	698.0
1.5KE530CA	1.5KE530A	450.00	503.00	556.00	1	1	2.1	725
1.5KE540CA	1.5KE540A	459.00	513.00	567.00	1	1	2.0	740.0
1.5KE550CA	1.5KE550A	467.00	522.50	577.50	1	1	2.0	760.0

PACKAGE OUTLINE DIMENSIONS in inches (millimeters) DO-201

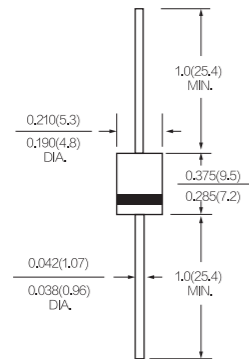

3KP Series 3000W (P-600)

Part Number (Bi)	Part Number (Uni)	Reverse Stand off Voltage V_R (Volts)	Breakdown Voltage V_{BR} (Volts)@ I_R		Test Current I_R (mA)	Maximum Reverse Leakage $I_{R@V_R}$ (μA)	Maximum Peak Pulse Current I_{pp} (A)	Maximum Clamping Voltage $V_C@I_{pp}$ (V)
			Min .V	Max.V				
3KP5.0CA	3KP5.0A	5.00	6.40	7.00	50	800	326.1	9.2
3KP6.0CA	3KP6.0A	6.00	6.67	7.37	50	800	291.3	10.3
3KP6.5CA	3KP6.5A	6.50	7.22	7.98	50	500	267.9	11.2
3KP7.0CA	3KP7.0A	7.00	7.78	8.60	50	200	250.0	12.0
3KP7.5CA	3KP7.5A	7.50	8.33	9.21	5	100	232.6	12.9
3KP8.0CA	3KP8.0A	8.00	8.99	10.23	5	50	220.6	13.6
3KP8.5CA	3KP8.5A	8.50	9.44	10.40	5	20	208.3	14.4
3KP9.0CA	3KP9.0A	9.00	10.00	11.10	5	10	194.8	15.4
3KP10CA	3KP10A	10.0	11.10	12.30	5	5	176.5	17.0
3KP11CA	3KP11A	11.0	12.20	13.50	5	2	164.8	18.2
3KP12CA	3KP12A	12.0	13.30	14.70	5	2	150.8	19.9
3KP13CA	3KP13A	13.0	14.40	15.90	5	2	139.5	21.5
3KP14CA	3KP14A	14.0	15.60	17.20	5	2	129.3	23.2
3KP15CA	3KP15A	15.0	16.70	18.50	5	2	123.0	24.4
3KP16CA	3KP16A	16.0	17.80	19.70	5	2	115.4	26.0
3KP17CA	3KP17A	17.0	18.90	20.90	5	2	108.7	27.6
3KP18CA	3KP18A	18.0	20.00	22.10	5	2	102.7	29.2
3KP20CA	3KP20A	20.0	22.20	24.50	5	2	92.6	32.4
3KP22CA	3KP22A	22.0	24.40	26.90	5	2	84.5	35.5
3KP24CA	3KP24A	24.0	26.70	29.50	5	2	77.1	38.9
3KP26CA	3KP26A	26.0	28.90	31.90	5	2	71.3	42.1
3KP28CA	3KP28A	28.0	31.10	34.40	5	2	66.1	45.4
3KP30CA	3KP30A	30.0	33.30	36.80	5	2	62.0	48.4
3KP33CA	3KP33A	33.0	36.70	40.60	5	2	53.3	56.3
3KP36CA	3KP36A	36.0	40.00	44.20	5	2	51.6	58.1



TVS

1.5KE Series 1500W (DO-201)

Part Number (Bi)	Part Number (Uni)	Reverse Stand off Voltage V_R (Volts)	Breakdown Voltage V_{BR} (Volts)@ I_R		Test Current I_R (mA)	Maximum Reverse Leakage $I_{R@V_R}$ (μA)	Maximum Peak Pulse Current I_{pp} (A)	Maximum Clamping Voltage $V_C@I_{pp}$ (V)
			Min .V	Max.V				
1.5KE130CA	1.5KE130A	111.00	124.00	137.00	1	1	8.5	179.0
1.5KE150CA	1.5KE150A	128.00	143.00	158.00	1	1	7.3	207.0
1.5KE160CA	1.5KE160A	136.00	152.00	168.00	1	1	6.9	219.0
1.5KE170CA	1.5KE170A	145.00	162.00	179.00	1	1	6.5	234.0
1.5KE180CA	1.5KE180A	154.00	171.00	189.00	1	1	6.2	246.0
1.5KE200CA	1.5KE200A	171.00	190.00	210.00	1	1	5.5	274.0
1.5KE220CA	1.5KE220A	185.00	209.00	231.00	1	1	4.6	328.0
1.5KE250CA	1.5KE250A	214.00	237.00	263.00	1	1	4.4	344.0
1.5KE300CA	1.5KE300A	256.00	285.00	315.00	1	1	3.7	414.0
1.5KE350CA	1.5KE350A	300.00	332.00	368.00	1	1	3.2	482.0
1.5KE400CA	1.5KE400A	342.00	380.00	420.00	1	1	2.8	548.0
1.5KE440CA	1.5KE440A	376.00	418.00	462.00	1	1	2.5	602.0
1.5KE480CA	1.5KE480A	408.00	456.00	504.00	1	1	2.3	658.0
1.5KE510CA	1.5KE510A	434.00	485.00	535.00	1	1	2.1	698.0
1.5KE530CA	1.5KE530A	450.00	503.00	556.00	1	1	2.1	725
1.5KE540CA	1.5KE540A	459.00	513.00	567.00	1	1	2.0	740.0
1.5KE550CA	1.5KE550A	467.00	522.50	577.50	1	1	2.0	760.0

PACKAGE OUTLINE DIMENSIONS in inches (millimeters) DO-201

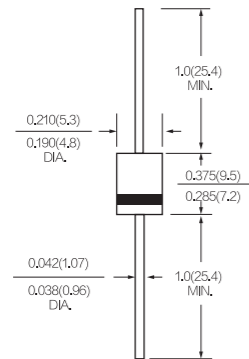

3KP Series 3000W (P-600)

Part Number (Bi)	Part Number (Uni)	Reverse Stand off Voltage V_R (Volts)	Breakdown Voltage V_{BR} (Volts)@ I_R		Test Current I_R (mA)	Maximum Reverse Leakage $I_{R@V_R}$ (μA)	Maximum Peak Pulse Current I_{pp} (A)	Maximum Clamping Voltage $V_C@I_{pp}$ (V)
			Min .V	Max.V				
3KP5.0CA	3KP5.0A	5.00	6.40	7.00	50	800	326.1	9.2
3KP6.0CA	3KP6.0A	6.00	6.67	7.37	50	800	291.3	10.3
3KP6.5CA	3KP6.5A	6.50	7.22	7.98	50	500	267.9	11.2
3KP7.0CA	3KP7.0A	7.00	7.78	8.60	50	200	250.0	12.0
3KP7.5CA	3KP7.5A	7.50	8.33	9.21	5	100	232.6	12.9
3KP8.0CA	3KP8.0A	8.00	8.99	10.23	5	50	220.6	13.6
3KP8.5CA	3KP8.5A	8.50	9.44	10.40	5	20	208.3	14.4
3KP9.0CA	3KP9.0A	9.00	10.00	11.10	5	10	194.8	15.4
3KP10CA	3KP10A	10.0	11.10	12.30	5	5	176.5	17.0
3KP11CA	3KP11A	11.0	12.20	13.50	5	2	164.8	18.2
3KP12CA	3KP12A	12.0	13.30	14.70	5	2	150.8	19.9
3KP13CA	3KP13A	13.0	14.40	15.90	5	2	139.5	21.5
3KP14CA	3KP14A	14.0	15.60	17.20	5	2	129.3	23.2
3KP15CA	3KP15A	15.0	16.70	18.50	5	2	123.0	24.4
3KP16CA	3KP16A	16.0	17.80	19.70	5	2	115.4	26.0
3KP17CA	3KP17A	17.0	18.90	20.90	5	2	108.7	27.6
3KP18CA	3KP18A	18.0	20.00	22.10	5	2	102.7	29.2
3KP20CA	3KP20A	20.0	22.20	24.50	5	2	92.6	32.4
3KP22CA	3KP22A	22.0	24.40	26.90	5	2	84.5	35.5
3KP24CA	3KP24A	24.0	26.70	29.50	5	2	77.1	38.9
3KP26CA	3KP26A	26.0	28.90	31.90	5	2	71.3	42.1
3KP28CA	3KP28A	28.0	31.10	34.40	5	2	66.1	45.4
3KP30CA	3KP30A	30.0	33.30	36.80	5	2	62.0	48.4
3KP33CA	3KP33A	33.0	36.70	40.60	5	2	53.3	56.3
3KP36CA	3KP36A	36.0	40.00	44.20	5	2	51.6	58.1



TVS

3KP Series 3000W (P-600)

Part Number (Bi)	Part Number (Uni)	Reverse Stand off Voltage V_R (Volts)	Breakdown Voltage V_{BR} (Volts)@ I_R		Test Current I_T (mA)	Maximum Reverse Leakage $I_R @ V_R$ (μA)	Maximum Peak Pulse Current I_{pp} (A)	Maximum Clamping Voltage $V_C @ I_{pp}$ (V)
			Min .V	Max.V				
3KP40CA	3KP40A	40.0	44.40	49.10	5	2	46.5	64.5
3KP43CA	3KP43A	43.0	47.80	52.80	5	2	43.2	69.4
3KP45CA	3KP45A	45.0	50.00	55.30	5	2	41.3	72.7
3KP48CA	3KP48A	48.0	53.30	58.90	5	2	38.8	77.4
3KP51CA	3KP51A	51.0	56.70	62.70	5	2	36.4	82.4
3KP54CA	3KP54A	54.0	60.00	66.30	5	2	34.4	87.1
3KP58CA	3KP58A	58.0	64.40	71.20	5	2	32.1	93.6
3KP60CA	3KP60A	60.0	66.70	73.70	5	2	31.0	96.8
3KP64CA	3KP64A	64.0	71.10	78.60	5	2	29.1	103.0
3KP70CA	3KP70A	70.0	77.80	86.00	5	2	26.5	113.0
3KP75CA	3KP75A	75.0	83.30	92.10	5	2	24.8	121.0
3KP78CA	3KP78A	78.0	86.70	95.80	5	2	23.8	126.0
3KP85CA	3KP85A	85.0	94.40	104.00	5	2	21.9	137.0
3KP90CA	3KP90A	90.0	100.00	111.00	5	2	20.5	146.0
3KP100CA	3KP100A	100.0	111.00	123.00	5	2	18.5	162.0
3KP110CA	3KP110A	110.0	122.00	135.00	5	2	16.9	177.0
3KP120CA	3KP120A	120.0	133.00	147.00	5	2	15.5	193.0
3KP130CA	3KP130A	130.0	144.00	159.00	5	2	14.4	209.0
3KP150CA	3KP150A	150.0	167.00	185.00	5	2	12.3	243.0
3KP160CA	3KP160A	160.0	178.00	197.00	5	2	11.6	259.0
3KP170CA	3KP170A	170.0	189.00	209.00	5	2	10.9	275.0
3KP180CA	3KP180A	180.0	200.00	221.00	5	2	10.4	289.0
3KP190CA	3KP190A	190.0	211.00	233.00	5	2	9.7	310.0
3KP200CA	3KP200A	200.0	222.00	246.00	5	2	9.1	329.2
3KP210CA	3KP210A	210.0	233.00	258.00	5	2	8.6	349.5
3KP220CA	3KP220A	220.0	244.00	270.00	5	2	8.1	371.1

5KP Series 5000W (P-600)

Part Number (Bi)	Part Number (Uni)	Reverse Stand off Voltage V_R (Volts)	Breakdown Voltage V_{BR} (Volts)@ I_R		Test Current I_T (mA)	Maximum Reverse Leakage $I_R @ V_R$ (μA)	Maximum Peak Pulse Current I_{pp} (A)	Maximum Clamping Voltage $V_C @ I_{pp}$ (V)
			Min .V	Max.V				
5KP5.0CA	5KP5.0A	5.00	6.40	7.00	50	5000	554.3	9.2
5KP6.0CA	5KP6.0A	6.00	6.67	7.37	50	5000	495.1	10.3
5KP6.5CA	5KP6.5A	6.50	7.22	7.98	50	2000	455.4	11.2
5KP7.0CA	5KP7.0A	7.00	7.78	8.60	50	1000	425.0	12.0
5KP7.5CA	5KP7.5A	7.50	8.33	9.21	5	250	395.3	12.9
5KP8.0CA	5KP8.0A	8.00	8.99	10.23	5	150	375.0	13.6
5KP8.5CA	5KP8.5A	8.50	9.44	10.40	5	500	354.2	14.4
5KP9.0CA	5KP9.0A	9.00	10.00	11.10	5	20	331.2	15.4
5KP10CA	5KP10A	10.0	11.10	12.30	5	15	300.0	17.0
5KP11CA	5KP11A	11.0	12.20	13.50	5	2	280.2	18.2
5KP12CA	5KP12A	12.0	13.30	14.70	5	2	256.3	19.9
5KP13CA	5KP13A	13.0	14.40	15.90	5	2	237.2	21.5
5KP14CA	5KP14A	14.0	15.60	17.20	5	2	219.8	23.2
5KP15CA	5KP15A	15.0	16.70	18.50	5	2	209.0	24.4
5KP16CA	5KP16A	16.0	17.80	19.70	5	2	196.2	26.0
5KP17CA	5KP17A	17.0	18.90	20.90	5	2	184.8	27.6
5KP18CA	5KP18A	18.0	20.00	22.10	5	2	174.7	29.2
5KP20CA	5KP20A	20.0	22.20	24.50	5	2	157.4	32.4
5KP22CA	5KP22A	22.0	24.40	26.90	5	2	143.7	35.5
5KP24CA	5KP24A	24.0	26.70	29.50	5	2	131.1	38.9
5KP26CA	5KP26A	26.0	28.90	31.90	5	2	121.1	42.1
5KP28CA	5KP28A	28.0	31.10	34.40	5	2	112.3	45.4
5KP30CA	5KP30A	30.0	33.30	36.80	5	2	105.4	48.4



3KP Series 3000W (P-600)

Part Number (Bi)	Part Number (Uni)	Reverse Stand off Voltage V_R (Volts)	Breakdown Voltage V_{BR} (Volts)@ I_R		Test Current I_T (mA)	Maximum Reverse Leakage $I @ V_R$ (μA)	Maximum Peak Pulse Current I_{pp} (A)	Maximum Clamping Voltage $V_C @ I_{pp}$ (V)
			Min .V	Max.V				
3KP40CA	3KP40A	40.0	44.40	49.10	5	2	46.5	64.5
3KP43CA	3KP43A	43.0	47.80	52.80	5	2	43.2	69.4
3KP45CA	3KP45A	45.0	50.00	55.30	5	2	41.3	72.7
3KP48CA	3KP48A	48.0	53.30	58.90	5	2	38.8	77.4
3KP51CA	3KP51A	51.0	56.70	62.70	5	2	36.4	82.4
3KP54CA	3KP54A	54.0	60.00	66.30	5	2	34.4	87.1
3KP58CA	3KP58A	58.0	64.40	71.20	5	2	32.1	93.6
3KP60CA	3KP60A	60.0	66.70	73.70	5	2	31.0	96.8
3KP64CA	3KP64A	64.0	71.10	78.60	5	2	29.1	103.0
3KP70CA	3KP70A	70.0	77.80	86.00	5	2	26.5	113.0
3KP75CA	3KP75A	75.0	83.30	92.10	5	2	24.8	121.0
3KP78CA	3KP78A	78.0	86.70	95.80	5	2	23.8	126.0
3KP85CA	3KP85A	85.0	94.40	104.00	5	2	21.9	137.0
3KP90CA	3KP90A	90.0	100.00	111.00	5	2	20.5	146.0
3KP100CA	3KP100A	100.0	111.00	123.00	5	2	18.5	162.0
3KP110CA	3KP110A	110.0	122.00	135.00	5	2	16.9	177.0
3KP120CA	3KP120A	120.0	133.00	147.00	5	2	15.5	193.0
3KP130CA	3KP130A	130.0	144.00	159.00	5	2	14.4	209.0
3KP150CA	3KP150A	150.0	167.00	185.00	5	2	12.3	243.0
3KP160CA	3KP160A	160.0	178.00	197.00	5	2	11.6	259.0
3KP170CA	3KP170A	170.0	189.00	209.00	5	2	10.9	275.0
3KP180CA	3KP180A	180.0	200.00	221.00	5	2	10.4	289.0
3KP190CA	3KP190A	190.0	211.00	233.00	5	2	9.7	310.0
3KP200CA	3KP200A	200.0	222.00	246.00	5	2	9.1	329.2
3KP210CA	3KP210A	210.0	233.00	258.00	5	2	8.6	349.5
3KP220CA	3KP220A	220.0	244.00	270.00	5	2	8.1	371.1

5KP Series 5000W (P-600)



Part Number (Bi)	Part Number (Uni)	Reverse Stand off Voltage V_R (Volts)	Breakdown Voltage V_{BR} (Volts)@ I_R		Test Current I_T (mA)	Maximum Reverse Leakage $I @ V_R$ (μA)	Maximum Peak Pulse Current I_{pp} (A)	Maximum Clamping Voltage $V_C @ I_{pp}$ (V)
			Min .V	Max.V				
5KP5.0CA	5KP5.0A	5.00	6.40	7.00	50	5000	554.3	9.2
5KP6.0CA	5KP6.0A	6.00	6.67	7.37	50	5000	495.1	10.3
5KP6.5CA	5KP6.5A	6.50	7.22	7.98	50	2000	455.4	11.2
5KP7.0CA	5KP7.0A	7.00	7.78	8.60	50	1000	425.0	12.0
5KP7.5CA	5KP7.5A	7.50	8.33	9.21	5	250	395.3	12.9
5KP8.0CA	5KP8.0A	8.00	8.99	10.23	5	150	375.0	13.6
5KP8.5CA	5KP8.5A	8.50	9.44	10.40	5	500	354.2	14.4
5KP9.0CA	5KP9.0A	9.00	10.00	11.10	5	20	331.2	15.4
5KP10CA	5KP10A	10.0	11.10	12.30	5	15	300.0	17.0
5KP11CA	5KP11A	11.0	12.20	13.50	5	2	280.2	18.2
5KP12CA	5KP12A	12.0	13.30	14.70	5	2	256.3	19.9
5KP13CA	5KP13A	13.0	14.40	15.90	5	2	237.2	21.5
5KP14CA	5KP14A	14.0	15.60	17.20	5	2	219.8	23.2
5KP15CA	5KP15A	15.0	16.70	18.50	5	2	209.0	24.4
5KP16CA	5KP16A	16.0	17.80	19.70	5	2	196.2	26.0
5KP17CA	5KP17A	17.0	18.90	20.90	5	2	184.8	27.6
5KP18CA	5KP18A	18.0	20.00	22.10	5	2	174.7	29.2
5KP20CA	5KP20A	20.0	22.20	24.50	5	2	157.4	32.4
5KP22CA	5KP22A	22.0	24.40	26.90	5	2	143.7	35.5
5KP24CA	5KP24A	24.0	26.70	29.50	5	2	131.1	38.9
5KP26CA	5KP26A	26.0	28.90	31.90	5	2	121.1	42.1
5KP28CA	5KP28A	28.0	31.10	34.40	5	2	112.3	45.4
5KP30CA	5KP30A	30.0	33.30	36.80	5	2	105.4	48.4

5KP Series 5000W (P-600)

Part Number (Bi)	Part Number (Uni)	Reverse Stand off Voltage V_R (Volts)	Breakdown Voltage V_{BR} (Volts)@ I_R		Test Current I_R (mA)	Maximum Reverse Leakage $I_{R@V_R}$ (μ A)	Maximum Peak Pulse Current I_{pp} (A)	Maximum Clamping Voltage $V_C@I_{pp}$ (V)
			Min .V	Max.V				
5KP33CA	5KP33A	33.0	36.70	40.60	5	2	95.7	56.3
5KP36CA	5KP36A	36.0	40.00	44.20	5	2	87.8	58.1
5KP40CA	5KP40A	40.0	44.40	49.10	5	2	79.1	64.5
5KP43CA	5KP43A	43.0	47.80	52.80	5	2	73.5	69.4
5KP45CA	5KP45A	45.0	50.00	55.30	5	2	70.2	72.7
5KP48CA	5KP48A	48.0	53.30	58.90	5	2	65.9	77.4
5KP51CA	5KP51A	51.0	56.70	62.70	5	2	61.9	82.4
5KP54CA	5KP54A	54.0	60.00	66.30	5	2	58.6	87.1
5KP58CA	5KP58A	58.0	64.40	71.20	5	2	54.5	93.6
5KP60CA	5KP60A	60.0	66.70	73.70	5	2	52.7	96.8
5KP64CA	5KP64A	64.0	71.10	78.60	5	2	49.5	103.0
5KP70CA	5KP70A	70.0	77.80	86.00	5	2	45.1	113.0
5KP75CA	5KP75A	75.0	83.30	92.10	5	2	42.1	121.0
5KP78CA	5KP78A	78.0	86.70	95.80	5	2	40.5	126.0
5KP85CA	5KP85A	85.0	94.40	104.00	5	2	37.2	137.0
5KP90CA	5KP90A	90.0	100.00	111.00	5	2	34.9	146.0
5KP100CA	5KP100A	100.0	111.00	123.00	5	2	31.5	162.0
5KP110CA	5KP110A	110.0	122.00	135.00	5	2	28.8	177.0
5KP120CA	5KP120A	120.0	133.00	147.00	5	2	26.4	193.0
5KP130CA	5KP130A	130.0	144.00	159.00	5	2	24.4	209.0
5KP150CA	5KP150A	150.0	167.00	185.00	5	2	21.0	243.0
5KP160CA	5KP160A	160.0	178.00	197.00	5	2	19.7	259.0
5KP170CA	5KP170A	170.0	189.00	209.00	5	2	18.5	275.0
5KP180CA	5KP180A	180.0	200.00	221.00	5	2	17.5	289.0

5KP Series 5000W (P-600)

Part Number (Bi)	Part Number (Uni)	Reverse Stand off Voltage V_R (Volts)	Breakdown Voltage V_{BR} (Volts)@ I_R		Test Current I_R (mA)	Maximum Reverse Leakage $I_{R@V_R}$ (μ A)	Maximum Peak Pulse Current I_{pp} (A)	Maximum Clamping Voltage $V_C@I_{pp}$ (V)
			Min .V	Max.V				
5KP190CA	5KP190A	190.0	211.00	233.00	5	2	16.5	310.0
5KP200CA	5KP200A	200.0	222.00	246.00	5	2	15.5	329.2
5KP210CA	5KP210A	210.0	233.00	258.00	5	2	14.6	349.5
5KP220CA	5KP220A	220.0	244.00	270.00	5	2	13.7	371.1
5KP250CA	5KP250A	250.0	277.00	306.00	5	2	12.0	425.0

PACKAGE OUTLINE DIMENSIONS in inches (millimeters) P600

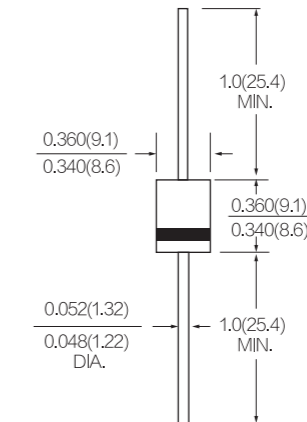

5KP Series 5000W (P-600)

Part Number (Bi)	Part Number (Uni)	Reverse Stand off Voltage V_R (Volts)	Breakdown Voltage V_{BR} (Volts)@ I_R		Test Current I_R (mA)	Maximum Reverse Leakage $I_{R@V_R}$ (μA)	Maximum Peak Pulse Current I_{pp} (A)	Maximum Clamping Voltage $V_C@I_{pp}$ (V)
			Min .V	Max.V				
5KP33CA	5KP33A	33.0	36.70	40.60	5	2	95.7	56.3
5KP36CA	5KP36A	36.0	40.00	44.20	5	2	87.8	58.1
5KP40CA	5KP40A	40.0	44.40	49.10	5	2	79.1	64.5
5KP43CA	5KP43A	43.0	47.80	52.80	5	2	73.5	69.4
5KP45CA	5KP45A	45.0	50.00	55.30	5	2	70.2	72.7
5KP48CA	5KP48A	48.0	53.30	58.90	5	2	65.9	77.4
5KP51CA	5KP51A	51.0	56.70	62.70	5	2	61.9	82.4
5KP54CA	5KP54A	54.0	60.00	66.30	5	2	58.6	87.1
5KP58CA	5KP58A	58.0	64.40	71.20	5	2	54.5	93.6
5KP60CA	5KP60A	60.0	66.70	73.70	5	2	52.7	96.8
5KP64CA	5KP64A	64.0	71.10	78.60	5	2	49.5	103.0
5KP70CA	5KP70A	70.0	77.80	86.00	5	2	45.1	113.0
5KP75CA	5KP75A	75.0	83.30	92.10	5	2	42.1	121.0
5KP78CA	5KP78A	78.0	86.70	95.80	5	2	40.5	126.0
5KP85CA	5KP85A	85.0	94.40	104.00	5	2	37.2	137.0
5KP90CA	5KP90A	90.0	100.00	111.00	5	2	34.9	146.0
5KP100CA	5KP100A	100.0	111.00	123.00	5	2	31.5	162.0
5KP110CA	5KP110A	110.0	122.00	135.00	5	2	28.8	177.0
5KP120CA	5KP120A	120.0	133.00	147.00	5	2	26.4	193.0
5KP130CA	5KP130A	130.0	144.00	159.00	5	2	24.4	209.0
5KP150CA	5KP150A	150.0	167.00	185.00	5	2	21.0	243.0
5KP160CA	5KP160A	160.0	178.00	197.00	5	2	19.7	259.0
5KP170CA	5KP170A	170.0	189.00	209.00	5	2	18.5	275.0
5KP180CA	5KP180A	180.0	200.00	221.00	5	2	17.5	289.0

5KP Series 5000W (P-600)

Part Number (Bi)	Part Number (Uni)	Reverse Stand off Voltage V_R (Volts)	Breakdown Voltage V_{BR} (Volts)@ I_R		Test Current I_R (mA)	Maximum Reverse Leakage $I_{R@V_R}$ (μA)	Maximum Peak Pulse Current I_{pp} (A)	Maximum Clamping Voltage $V_C@I_{pp}$ (V)
			Min .V	Max.V				
5KP190CA	5KP190A	190.0	211.00	233.00	5	2	16.5	310.0
5KP200CA	5KP200A	200.0	222.00	246.00	5	2	15.5	329.2
5KP210CA	5KP210A	210.0	233.00	258.00	5	2	14.6	349.5
5KP220CA	5KP220A	220.0	244.00	270.00	5	2	13.7	371.1
5KP250CA	5KP250A	250.0	277.00	306.00	5	2	12.0	425.0

PACKAGE OUTLINE DIMENSIONS in inches (millimeters) P600

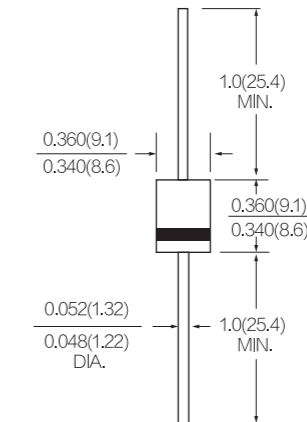

15KP Series 15000W (P-600)



Part Number (Bi)	Part Number (Uni)	Reverse Stand off Voltage V_R (Volts)	Breakdown Voltage V_{BR} (Volts)@ I_R		Test Current I_R (mA)	Maximum Reverse Leakage $I_R @ V_R$ (μA)	Maximum Peak Pulse Current I_{pp} (A)	Maximum Clamping Voltage $V_C @ I_{pp}$ (V)
			Min. V	Max. V				
15KP17CA	15KP17A	17.0	18.88	20.80	50	5000	515.4	29.3
15KP18CA	15KP18A	18.0	20.00	22.20	50	5000	488.7	30.9
15KP20CA	15KP20A	20.0	22.20	24.60	20	1500	440.2	34.3
15KP22CA	15KP22A	22.0	24.40	27.00	10	500	407.0	37.1
15KP24CA	15KP24A	24.0	26.60	29.40	5	150	371.0	40.7
15KP26CA	15KP26A	26.0	28.80	31.80	5	50	343.2	44.0
15KP28CA	15KP28A	28.0	31.10	34.40	5	25	317.9	47.5
15KP30CA	15KP30A	30.0	33.30	36.90	5	15	297.8	50.7
15KP33CA	15KP33A	33.0	36.60	40.50	5	2	276.1	54.7
15KP36CA	15KP36A	36.0	39.90	44.10	5	2	252.5	59.8
15KP40CA	15KP40A	40.0	44.40	49.10	5	2	229.5	65.8
15KP43CA	15KP43A	43.0	47.80	52.80	5	2	216.3	69.8
15KP45CA	15KP45A	45.0	50.10	55.50	5	2	207.4	72.8
15KP48CA	15KP48A	48.0	53.40	59.10	5	2	194.3	77.7
15KP51CA	15KP51A	51.0	56.70	62.70	5	2	182.1	82.9
15KP54CA	15KP54A	54.0	60.00	66.30	5	2	172.2	87.7
15KP58CA	15KP58A	58.0	64.40	71.20	5	2	161.0	93.8
15KP60CA	15KP60A	60.0	66.60	73.50	5	2	155.0	97.4
15KP64CA	15KP64A	64.0	71.10	78.60	5	2	144.9	104.2
15KP70CA	15KP70A	70.0	77.80	86.00	5	2	132.9	113.6
15KP75CA	15KP75A	75.0	83.30	92.10	5	2	123.8	122.0
15KP78CA	15KP78A	78.0	86.70	95.70	5	2	119.7	126.1
15KP85CA	15KP85A	85.0	94.40	104.0	5	2	109.7	137.6
15KP90CA	15KP90A	90.0	99.90	110.4	5	2	103.7	145.6
15KP100CA	15KP100A	100.0	111.0	123.0	5	2	93.6	161.3
15KP110CA	15KP110A	110.0	122.0	135.0	5	2	84.5	178.6
15KP120CA	15KP120A	120.0	133.2	147.3	5	2	78.5	192.3
15KP130CA	15KP130A	130.0	144.0	159.0	5	2	72.5	208.3

15KP Series 15000W (P-600)

Part Number (Bi)	Part Number (Uni)	Reverse Stand off Voltage V_R (Volts)	Breakdown Voltage V_{BR} (Volts)@ I_R		Test Current I_R (mA)	Maximum Reverse Leakage $I_R @ V_R$ (μA)	Maximum Peak Pulse Current I_{pp} (A)	Maximum Clamping Voltage $V_C @ I_{pp}$ (V)
			Min. V	Max. V				
15KP150CA	15KP150A	150.0	167.0	185.0	5	2	62.4	241.9
15KP160CA	15KP160A	160.0	178.0	197.0	5	2	58.4	258.6
15KP170CA	15KP170A	170.0	189.0	209.0	5	2	55.4	272.7
15KP180CA	15KP180A	180.0	200.1	221.0	5	2	52.3	288.5
15KP200CA	15KP200A	200.0	222.0	247.0	5	2	47.3	319.1
15KP220CA	15KP220A	220.0	244.0	272.0	5	2	35.2	352.5
15KP240CA	15KP240A	240.0	267.4	293.9	5	2	39.3	384.6
15KP260CA	15KP260A	260.0	289.6	318.2	5	2	36.2	416.7
15KP280CA	15KP280A	280.0	312.1	342.5	5	2	33.2	454.5

PACKAGE OUTLINE DIMENSIONS in inches (millimeters) P600

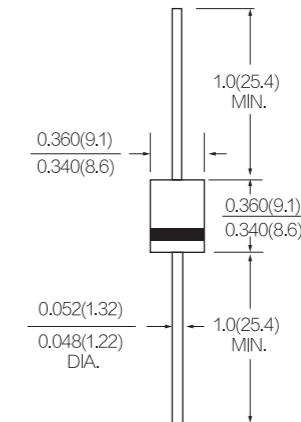

15KP Series 15000W (P-600)



Part Number (Bi)	Part Number (Uni)	Reverse Stand off Voltage V_R (Volts)	Breakdown Voltage V_{BR} (Volts)@ I_R		Test Current I_R (mA)	Maximum Reverse Leakage $I_R @ V_R$ (μA)	Maximum Peak Pulse Current I_{pp} (A)	Maximum Clamping Voltage $V_C @ I_{pp}$ (V)
			Min. V	Max. V				
15KP17CA	15KP17A	17.0	18.88	20.80	50	5000	515.4	29.3
15KP18CA	15KP18A	18.0	20.00	22.20	50	5000	488.7	30.9
15KP20CA	15KP20A	20.0	22.20	24.60	20	1500	440.2	34.3
15KP22CA	15KP22A	22.0	24.40	27.00	10	500	407.0	37.1
15KP24CA	15KP24A	24.0	26.60	29.40	5	150	371.0	40.7
15KP26CA	15KP26A	26.0	28.80	31.80	5	50	343.2	44.0
15KP28CA	15KP28A	28.0	31.10	34.40	5	25	317.9	47.5
15KP30CA	15KP30A	30.0	33.30	36.90	5	15	297.8	50.7
15KP33CA	15KP33A	33.0	36.60	40.50	5	2	276.1	54.7
15KP36CA	15KP36A	36.0	39.90	44.10	5	2	252.5	59.8
15KP40CA	15KP40A	40.0	44.40	49.10	5	2	229.5	65.8
15KP43CA	15KP43A	43.0	47.80	52.80	5	2	216.3	69.8
15KP45CA	15KP45A	45.0	50.10	55.50	5	2	207.4	72.8
15KP48CA	15KP48A	48.0	53.40	59.10	5	2	194.3	77.7
15KP51CA	15KP51A	51.0	56.70	62.70	5	2	182.1	82.9
15KP54CA	15KP54A	54.0	60.00	66.30	5	2	172.2	87.7
15KP58CA	15KP58A	58.0	64.40	71.20	5	2	161.0	93.8
15KP60CA	15KP60A	60.0	66.60	73.50	5	2	155.0	97.4
15KP64CA	15KP64A	64.0	71.10	78.60	5	2	144.9	104.2
15KP70CA	15KP70A	70.0	77.80	86.00	5	2	132.9	113.6
15KP75CA	15KP75A	75.0	83.30	92.10	5	2	123.8	122.0
15KP78CA	15KP78A	78.0	86.70	95.70	5	2	119.7	126.1
15KP85CA	15KP85A	85.0	94.40	104.0	5	2	109.7	137.6
15KP90CA	15KP90A	90.0	99.90	110.4	5	2	103.7	145.6
15KP100CA	15KP100A	100.0	111.0	123.0	5	2	93.6	161.3
15KP110CA	15KP110A	110.0	122.0	135.0	5	2	84.5	178.6
15KP120CA	15KP120A	120.0	133.2	147.3	5	2	78.5	192.3
15KP130CA	15KP130A	130.0	144.0	159.0	5	2	72.5	208.3

15KP Series 15000W (P-600)

Part Number (Bi)	Part Number (Uni)	Reverse Stand off Voltage V_R (Volts)	Breakdown Voltage V_{BR} (Volts)@ I_R		Test Current I_R (mA)	Maximum Reverse Leakage $I_R @ V_R$ (μA)	Maximum Peak Pulse Current I_{pp} (A)	Maximum Clamping Voltage $V_C @ I_{pp}$ (V)
			Min. V	Max. V				
15KP150CA	15KP150A	150.0	167.0	185.0	5	2	62.4	241.9
15KP160CA	15KP160A	160.0	178.0	197.0	5	2	58.4	258.6
15KP170CA	15KP170A	170.0	189.0	209.0	5	2	55.4	272.7
15KP180CA	15KP180A	180.0	200.1	221.0	5	2	52.3	288.5
15KP200CA	15KP200A	200.0	222.0	247.0	5	2	47.3	319.1
15KP220CA	15KP220A	220.0	244.0	272.0	5	2	35.2	352.5
15KP240CA	15KP240A	240.0	267.4	293.9	5	2	39.3	384.6
15KP260CA	15KP260A	260.0	289.6	318.2	5	2	36.2	416.7
15KP280CA	15KP280A	280.0	312.1	342.5	5	2	33.2	454.5

PACKAGE OUTLINE DIMENSIONS in inches (millimeters) P600

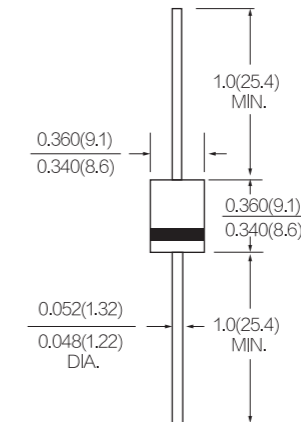

静电保护元件 ESD (Electrostatic Discharge Devices)

YINT静电保护元件阵列可保护电子设备免受雷击和静电放电 (ESD) 等快速瞬态电压的破坏, 为输入/输出接口和数字与模拟信号线提供了理想的保护方案。

YINT的ESD器件封装通常包括: SOD323, SOD523, SOD882, SOD923, SOT23, SOT553, SOT563, SOT353, SOT363, SOT143, SOT23-6L, SOP-8, DFN等。

The array of ESD could preventing electronic equipment from damaging by fast transient voltages such as lightning and electrostatic discharge (ESD), providing an effective protection solution for input/output interfaces and digital and analog signal lines.

The packaging of ESD including: SOD323, SOD523, SOD882, SOD923, SOT23, SOT553, SOT563, SOT353, SOT363, SOT143, SOT23-6L, SOP-8, DFN, etc.

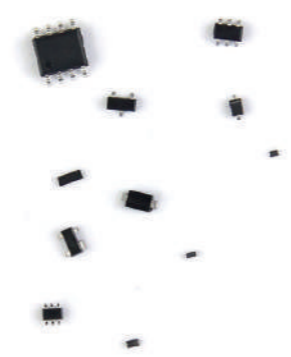

特点 Features

- ▲ 响应速度快 Fast response time
- ▲ 小尺寸封装 Small package size
- ▲ 低钳位电压 Low clamping voltage
- ▲ 低漏电流 Low leakage current
- ▲ YINT可提供三种类型的ESD器件: 标准电容 (大于100pf), 低电容 (5-100pF), 超低电容 (小于5pf)
YINT offers three types of TVS Diode Arrays: Standard Capacitance (more than 100pF), Low Capacitance (5-100pF), Ultra Low Capacitance (less than 5pF)
- ▲ 符合IEC 61000-4-2(ESD) : Air 15KV , Contact 8KV
Compatible with IEC 61000-4-2(ESD) : Air 15KV , Contact 8KV

Some of the applications discussed in this guide are:

- ▲ USB1,1/2,0/3,0
- ▲ HDMI
- ▲ DisplayPort
- ▲ DVI
- ▲ 10/100/1000 Ethernet
- ▲ eSATA
- ▲ 1394a/b
- ▲ LVDS
- ▲ Audio (Speaker/Microphone)
- ▲ Analog Video
- ▲ SIM Sockets
- ▲ RS-232
- ▲ RS-485
- ▲ CAN Bus
- ▲ Keypad/Push button
- ▲ LCD/Camera display interfaces

Many of these applications can be found in electronic devices such as:

- ▲ PC' s
- ▲ Portable Medical Devices
- ▲ Set Top Boxes
- ▲ LCD/PDP
- ▲ Portable Navigation Devices
- ▲ Keyboards/Mouse
- ▲ Mobile Handsets
- ▲ MP3/PMP' s
- ▲ PDA' s
- ▲ Digital Cameras
- ▲ SIM/SD Cards
- ▲ External Storage
- ▲ Switches/Routers
- ▲ Smart Phone



Definitions and Terms

Reverse Standoff Voltage(VRWM)

The VRWM of ESD should be equal to, or greater than the peak operating voltage of circuit(or part of the circuit)to be protected.This is to ensure the normal operation of circuit will not be affected.

Reverse breakdown Voltage(VBR)

Clamp Voltage(VC)

Maximum voltage which can be measured across the protector when subjected to the maximum peak pulse current

Reverse Leakage Current(IR)

Maximum of state current measured at specified voltage

Junction Capacitance (C)

VR=0V, f = 1MHz Between I/O pins or Any I/O pin to ground

术语定义

反向关断电压 (VRWM)

ESD的VRWM必须大于或者等于被保护电路 (或者被保护电路一部分) 的峰值操作电压, 这是为了确保ESD器件不影响电路的正常工作。

反向击穿电压(VBR)

钳位电压 (VC)

当受到最大的浪涌电流冲击时, 保护器件两端测量到的最大电压

反向漏电流 (IR)

在额定电压下最大的漏电流

结电容 (C)

I/O pin之间或I/O pin与地之间的寄生电容

静电保护元件 ESD (Electrostatic Discharge Devices)

YINT静电保护元件阵列可保护电子设备免受雷击和静电放电 (ESD) 等快速瞬态电压的破坏, 为输入/输出接口和数字与模拟信号线提供了理想的保护方案。

YINT的ESD器件封装通常包括: SOD323, SOD523, SOD882, SOD923, SOT23, SOT553, SOT563, SOT353, SOT363, SOT143, SOT23-6L, SOP-8, DFN等。

The array of ESD could preventing electronic equipment from damaging by fast transient voltages such as lightning and electrostatic discharge (ESD), providing an effective protection solution for input/output interfaces and digital and analog signal lines.

The packaging of ESD including: SOD323, SOD523, SOD882, SOD923, SOT23, SOT553, SOT563, SOT353, SOT363, SOT143, SOT23-6L, SOP-8, DFN, etc.

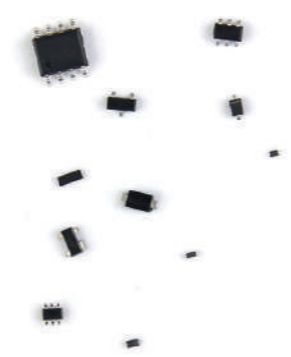

特点 Features

- ▲ 响应速度快 Fast response time
- ▲ 小尺寸封装 Small package size
- ▲ 低钳位电压 Low clamping voltage
- ▲ 低漏电流 Low leakage current
- ▲ YINT可提供三种类型的ESD器件: 标准电容 (大于100pf), 低电容 (5-100pF), 超低电容 (小于5pf)
YINT offers three types of TVS Diode Arrays: Standard Capacitance (more than 100pF), Low Capacitance (5-100pF), Ultra Low Capacitance (less than 5pF)
- ▲ 符合IEC 61000-4-2(ESD) : Air 15KV , Contact 8KV
Compatible with IEC 61000-4-2(ESD) : Air 15KV , Contact 8KV

Some of the applications discussed in this guide are:

- ▲ USB1,1/2,0/3,0
- ▲ HDMI
- ▲ DisplayPort
- ▲ DVI
- ▲ 10/100/1000 Ethernet
- ▲ eSATA
- ▲ 1394a/b
- ▲ LVDS
- ▲ Audio (Speaker/Microphone)
- ▲ Analog Video
- ▲ SIM Sockets
- ▲ RS-232
- ▲ RS-485
- ▲ CAN Bus
- ▲ Keypad/Push button
- ▲ LCD/Camera display interfaces

Many of these applications can be found in electronic devices such as:

- ▲ PC' s
- ▲ Portable Medical Devices
- ▲ Set Top Boxes
- ▲ LCD/PDP
- ▲ Portable Navigation Devices
- ▲ Keyboards/Mouse
- ▲ Mobile Handsets
- ▲ MP3/PMP' s
- ▲ PDA' s
- ▲ Digital Cameras
- ▲ SIM/SD Cards
- ▲ External Storage
- ▲ Switches/Routers
- ▲ Smart Phone



Definitions and Terms

Reverse Standoff Voltage(VRWM)

The VRWM of ESD should be equal to, or greater than the peak operating voltage of circuit(or part of the circuit)to be protected.This is to ensure the normal operation of circuit will not be affected.

Reverse breakdown Voltage(VBR)

Clamp Voltage(VC)

Maximum voltage which can be measured across the protector when subjected to the maximum peak pulse current

Reverse Leakage Current(IR)

Maximum of state current measured at specified voltage

Junction Capacitance (C)

VR=0V, f = 1MHz Between I/O pins or Any I/O pin to ground

术语定义

反向关断电压 (VRWM)

ESD的VRWM必须大于或者等于被保护电路 (或者被保护电路一部分) 的峰值操作电压, 这是为了确保ESD器件不影响电路的正常工作。

反向击穿电压(VBR)

钳位电压 (VC)

当受到最大的浪涌电流冲击时, 保护器件两端测量到的最大电压

反向漏电流 (IR)

在额定电压下最大的漏电流

结电容 (C)

I/O pin之间或I/O pin与地之间的寄生电容

SOD323

Part number	VRWM	IR (μA)	VBR (V)	IT(mA)	VC (V)	Ppk	C	PACKAGE
	(V)	@ VRWM	@ IT		@IPP=1A	(W)	(pF)	
ESD3V3D3	3.3	10	5	1	6.5	350	500	SOD-323
ESD5V0D3	5	10	6		9.8	350	350	
ESD8V0D3	8	10	8.5		13.4	350	150	
ESD12VD3	12	1	13.3		19	350	120	
ESD15VD3	15	1	16.7		24	350	100	
ESD24VD3	24	1	26.7		43	350	80	
ESD36VD3	36	1	40		60	350	30	

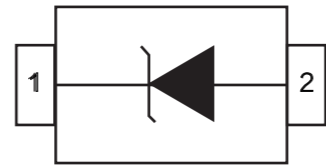

Part number	VRWM	IR (μA)	VBR (V)	IT(mA)	VC (V)	Ppk	C	PACKAGE
	(V)	@ VRWM	@ IT		@IPP=1A	(W)	(pF)	
ESD3V3D3B	3.3	200	4	1	7	320	350	SOD-323
ESD5V0D3B	5	10	6		9.8	320	260	
ESD8V0D3B	8	5	8.5		13.4	320	120	
ESD12VD3B	12	1	13.3		19	320	110	
ESD15VD3B	15	1	16.7		24	320	100	
ESD24VD3B	24	1	26.7		43	320	75	
ESD36VD3B	36	1	40		60	320	35	

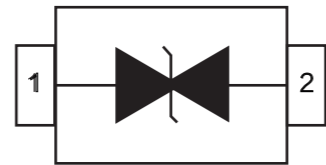

SOD323

Part number	VRWM	IR (μA)	VBR (V)	IT(mA)	VC (V)	Ppk	C	PACKAGE
	(V)	@ VRWM	@ IT		@IPP=1A	(W)	(pF)	
ESDLC3V3D3	3.3	40	4	1	5.15	350	1	SOD-323
ESDLC5V0D3	5	5	6		9.8	350	1	
ESDLC8V0D3	8	2	8.5		13.4	350	1	
ESDLC12VD3	12	1	13.3		19	350	1	
ESDLC15VD3	15	1	16.7		24	350	1	
ESDLC24VD3	24	1	26.7		43	350	1	

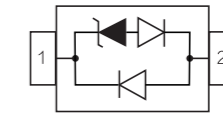

Part number	VRWM	IR (μA)	VBR (V)	IT(mA)	VC (V)	Ppk	C	PACKAGE
	(V)	@ VRWM	@ IT		@IPP=1A	(W)	(pF)	
ESDLC3V3D3B	3.3	40	4	1	7.5	350	1	SOD-323
ESDLC5V0D3B	5	5	6		9.8	350	1	
ESDLC8V0D3B	8	2	8.5		13.4	350	1	
ESDLC12VD3B	12	1	13.3		19	350	1	
ESDLC15VD3B	15	1	16.7		24	350	1	
ESDLC24VD3B	24	1	26.7		43	350	1	

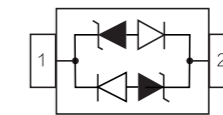

PACKAGE OUTLINE DIMENSIONS in millimeters (inches) :SOD323

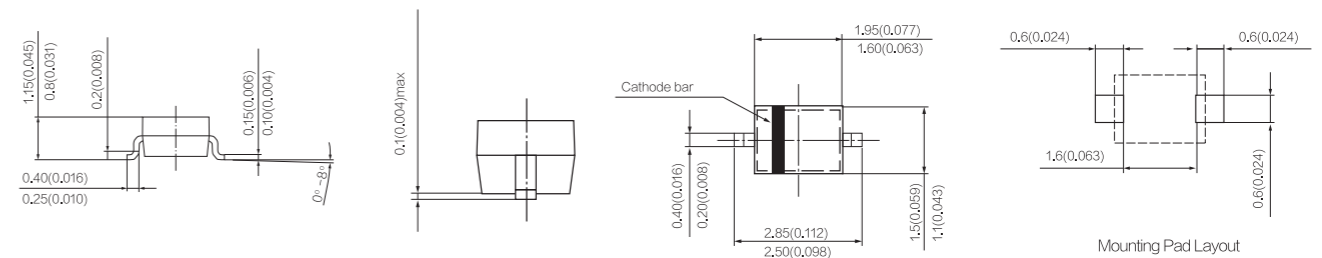

ESD

SOD323

Part number	VRWM	IR (μA)	VBR (V)	IT(mA)	VC (V)	Ppk	C	PACKAGE
	(V)	@ VRWM	@ IT		@ IPP=1A	(W)	(pF)	
ESD3V3D3	3.3	10	5	1	6.5	350	500	SOD-323
ESD5V0D3	5	10	6		9.8	350	350	
ESD8V0D3	8	10	8.5		13.4	350	150	
ESD12VD3	12	1	13.3		19	350	120	
ESD15VD3	15	1	16.7		24	350	100	
ESD24VD3	24	1	26.7		43	350	80	
ESD36VD3	36	1	40		60	350	30	

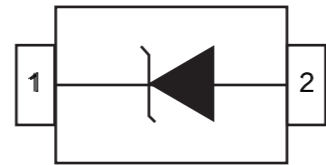

Part number	VRWM	IR (μA)	VBR (V)	IT(mA)	VC (V)	Ppk	C	PACKAGE
	(V)	@ VRWM	@ IT		@ IPP=1A	(W)	(pF)	
ESD3V3D3B	3.3	200	4	1	7	320	350	SOD-323
ESD5V0D3B	5	10	6		9.8	320	260	
ESD8V0D3B	8	5	8.5		13.4	320	120	
ESD12VD3B	12	1	13.3		19	320	110	
ESD15VD3B	15	1	16.7		24	320	100	
ESD24VD3B	24	1	26.7		43	320	75	
ESD36VD3B	36	1	40		60	320	35	

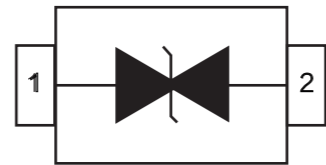

SOD323

Part number	VRWM	IR (μA)	VBR (V)	IT(mA)	VC (V)	Ppk	C	PACKAGE
	(V)	@ VRWM	@ IT		@ IPP=1A	(W)	(pF)	
ESDLC3V3D3	3.3	40	4	1	5.15	350	1	SOD-323
ESDLC5V0D3	5	5	6		9.8	350	1	
ESDLC8V0D3	8	2	8.5		13.4	350	1	
ESDLC12VD3	12	1	13.3		19	350	1	
ESDLC15VD3	15	1	16.7		24	350	1	
ESDLC24VD3	24	1	26.7		43	350	1	

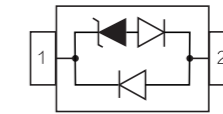

Part number	VRWM	IR (μA)	VBR (V)	IT(mA)	VC (V)	Ppk	C	PACKAGE
	(V)	@ VRWM	@ IT		@ IPP=1A	(W)	(pF)	
ESDLC3V3D3B	3.3	40	4	1	7.5	350	1	SOD-323
ESDLC5V0D3B	5	5	6		9.8	350	1	
ESDLC8V0D3B	8	2	8.5		13.4	350	1	
ESDLC12VD3B	12	1	13.3		19	350	1	
ESDLC15VD3B	15	1	16.7		24	350	1	
ESDLC24VD3B	24	1	26.7		43	350	1	

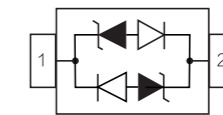

PACKAGE OUTLINE DIMENSIONS in millimeters (inches) :SOD323

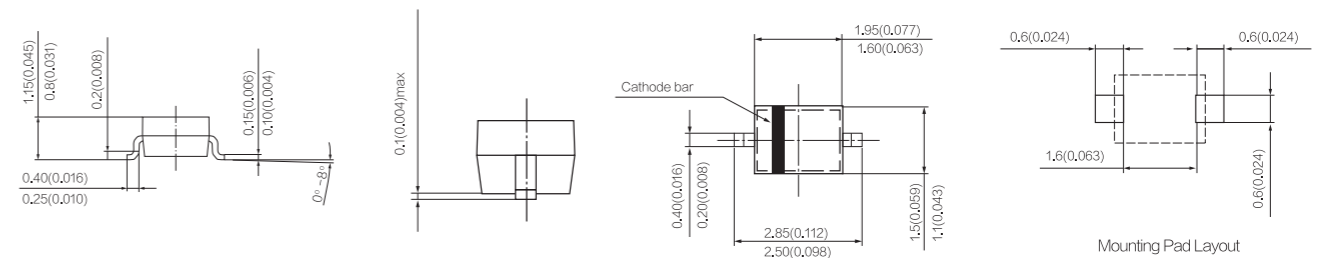

SOD523

Part number	VRWM	IR (μA)	VBR (V)	IT(mA)	VC (V)	Ppk	C	PACKAGE
	(V)	@ VRWM	@ IT		@IPP=1A	(W)	(pF)	
ESD3V3D5	3.3	1	4	1	7	200	105	SOD523
ESD5V0D5	5	1	6		9.8	200	100	
ESD8V0D5	8	5	8.5		13	200	70	
ESD12VD5	12	1	13.3		15	200	45	
ESD15VD5	15	1	16.6		21	200	50	
ESD24VD5	24	1	27		40	200	40	
ESDULC5V0D5	5	1	5.4		12.9	200	0.5	

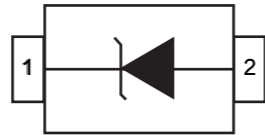

Part number	VRWM	IR (μA)	VBR (V)	IT(mA)	VC (V)	Ppk	C	PACKAGE
	(V)	@ VRWM	@ IT		@IPP=1A	(W)	(pF)	
ESD3V3D5B	3.3	2.5	4	1	7	100	18	SOD523
ESD5V0D5B	5	1	6.2		9.8	200	25	
ESD8V0D5B	8	1	8.5		17.5	100	10	
ESDULC5V0D5B	5	1	6		12.9	200	0.5	



PACKAGE OUTLINE DIMENSIONS in millimeters (inches) :SOD523

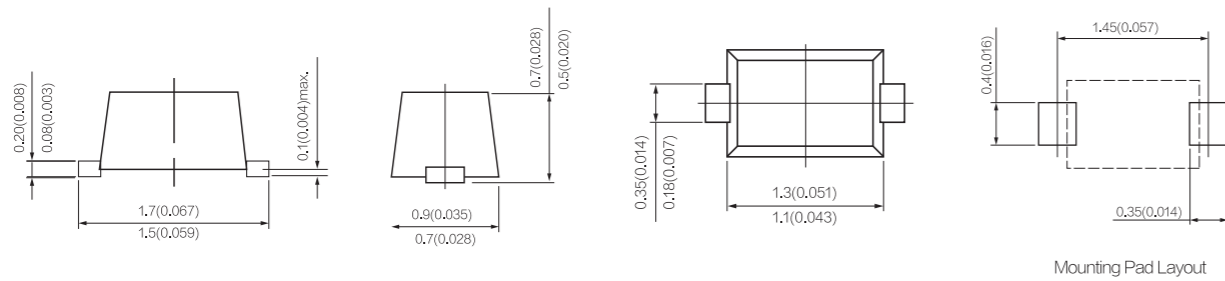

SOD882(DFN1006)

Part number	VRWM	IR (μA)	VBR (V)	IT(mA)	VC (V)	Ppk	C	PACKAGE
	(V)	@ VRWM	@ IT		@IPP=1A	(W)	(pF)	
ESD3V3D8	3.3	2.5	5	1	10.4	102	80	SOD882
ESD5V0D8	5	1	6.2		12.3	107	65	
ESD12VD8	12	1	13.3		23.7	140	30	
ESD24VD8	24	1	26.7		36	100	25	
ESDULC3V3D8	3.3	1	4.8		12	60	0.5	
ESDULC5V0D8	5	1	5.4		9.8	120	0.5	

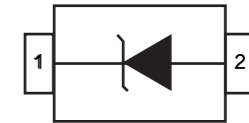
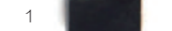

Part number	VRWM	IR (μA)	VBR (V)	IT(mA)	VC (V)	Ppk	C	PACKAGE
	(V)	@ VRWM	@ IT		@IPP=1A	(W)	(pF)	
ESD3V3D8B	3.3	1	5	1	8.4	150	25	SOD882
ESD5V0D8B	5	1	5.6		11.6	100	15	
ESD12VD8B	12	1	13.3		18	72	9.5	
ESDLC5V0D8B	5	1	5.5		11.5	100	3.5	
ESDLC24VD8B	24	1	27		35	180	10	
ESDULC3V3D8B	3.3	1	4.8		10	150	0.5	
ESDULC5V0D8B	5	1	6	11	100	0.5		

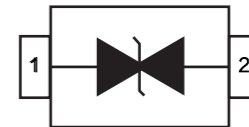
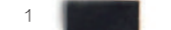

PACKAGE OUTLINE DIMENSIONS in millimeters :SOD882(DFN1006)

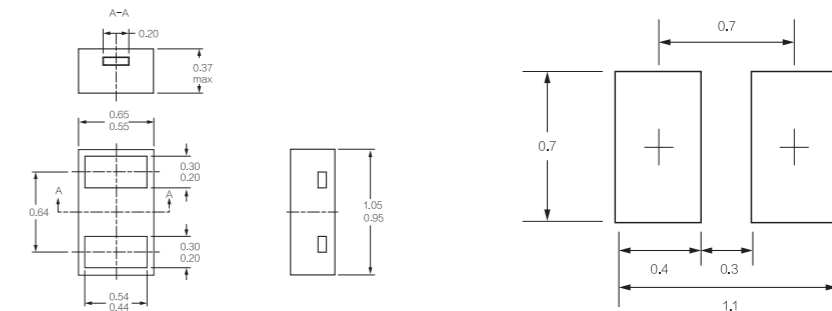

SOD523

Part number	VRWM	IR (μA)	VBR (V)	IT(mA)	VC (V)	Ppk	C	PACKAGE
	(V)	@ VRWM	@ IT		@IPP=1A	(W)	(pF)	
ESD3V3D5	3.3	1	4	1	7	200	105	SOD523
ESD5V0D5	5	1	6		9.8	200	100	
ESD8V0D5	8	5	8.5		13	200	70	
ESD12VD5	12	1	13.3		15	200	45	
ESD15VD5	15	1	16.6		21	200	50	
ESD24VD5	24	1	27		40	200	40	
ESDULC5V0D5	5	1	5.4		12.9	200	0.5	

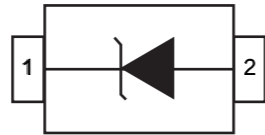

Part number	VRWM	IR (μA)	VBR (V)	IT(mA)	VC (V)	Ppk	C	PACKAGE
	(V)	@ VRWM	@ IT		@IPP=1A	(W)	(pF)	
ESD3V3D5B	3.3	2.5	4	1	7	100	18	SOD523
ESD5V0D5B	5	1	6.2		9.8	200	25	
ESD8V0D5B	8	1	8.5		17.5	100	10	
ESDULC5V0D5B	5	1	6		12.9	200	0.5	



PACKAGE OUTLINE DIMENSIONS in millimeters (inches) :SOD523

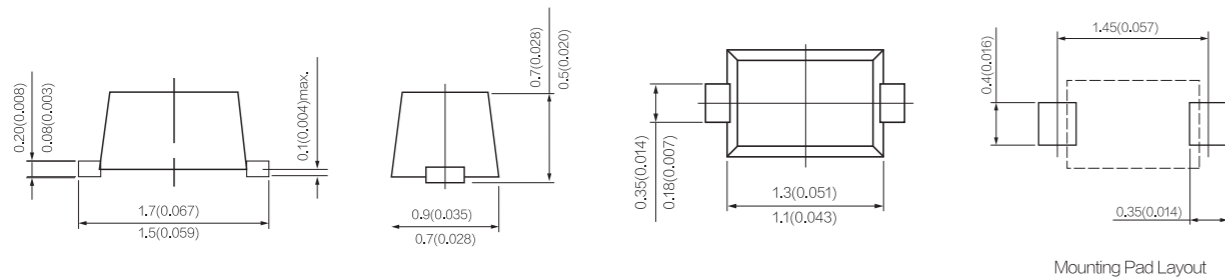

SOD882(DFN1006)

Part number	VRWM	IR (μA)	VBR (V)	IT(mA)	VC (V)	Ppk	C	PACKAGE
	(V)	@ VRWM	@ IT		@IPP=1A	(W)	(pF)	
ESD3V3D8	3.3	2.5	5	1	10.4	102	80	SOD882
ESD5V0D8	5	1	6.2		12.3	107	65	
ESD12VD8	12	1	13.3		23.7	140	30	
ESD24VD8	24	1	26.7		36	100	25	
ESDULC3V3D8	3.3	1	4.8		12	60	0.5	
ESDULC5V0D8	5	1	5.4		9.8	120	0.5	

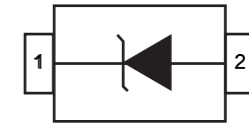

Part number	VRWM	IR (μA)	VBR (V)	IT(mA)	VC (V)	Ppk	C	PACKAGE
	(V)	@ VRWM	@ IT		@IPP=1A	(W)	(pF)	
ESD3V3D8B	3.3	1	5	1	8.4	150	25	SOD882
ESD5V0D8B	5	1	5.6		11.6	100	15	
ESD12VD8B	12	1	13.3		18	72	9.5	
ESDLC5V0D8B	5	1	5.5		11.5	100	3.5	
ESDLC24VD8B	24	1	27		35	180	10	
ESDULC3V3D8B	3.3	1	4.8		10	150	0.5	
ESDULC5V0D8B	5	1	6		11	100	0.5	



PACKAGE OUTLINE DIMENSIONS in millimeters :SOD882(DFN1006)

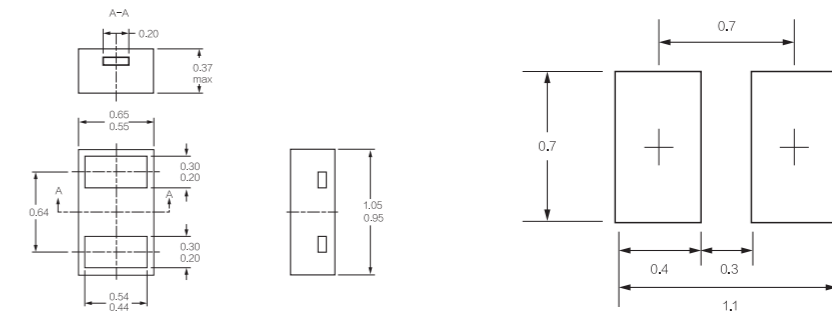

ESD

SOD923

Part number	VRWM	IR (μA)	VBR (V)	IT(mA)	VC (V) @IPP=1A	Ppk (W)	C (pF)	PACKAGE
	(V)	@ VRWM	@ IT					
ESD3V3D9	3.3	2.5	5	1	6.5	88	45	SOD-923
ESD5V0D9	5	1	6.2		9.8	107	65	
ESD12VD9	12	1	13.5		23.7	140	30	
ESDULC3V3D9	3.3	1	4.8		12	50	0.5	
ESDULC5V0D9	5	1	5.4		9.8	50	0.5	

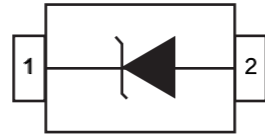

Part number	VRWM	IR (μA)	VBR (V)	IT(mA)	VC (V) @IPP=1A	Ppk (W)	C (pF)	PACKAGE
	(V)	@ VRWM	@ IT					
ESD3V3D9B	3.3	1	5.1	1	14.1	150	25	SOD-923
ESD5V0D9B	5	1	6		18.6	150	15	
ESD12V0D9B	12	1	13.8		30	150	14	
ESDULC3V3D9B	3.3	1	4.8		10	50	0.9	
ESDULC5V0D9B	5	1	5.4		12.9	50	0.9	

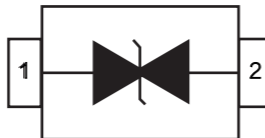

PACKAGE OUTLINE DIMENSIONS in millimeters (inches) :SOD923

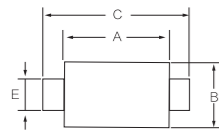

Mounting Pad Layout(mm)

Dim	Inches		Millimeters	
	MIN	MAX	MIN	MAX
A	0.030	0.033	0.75	0.85
B	0.022	0.026	0.55	0.65
C	0.037	0.041	0.95	1.05
D	0.014	0.017	0.36	0.43
E	0.006	0.010	0.15	0.25
F	0.002	0.006	0.05	0.15
H	0.003	0.007	0.07	0.17

SOT23

Part number	VRWM	IR (μA)	VBR (V)	IT(mA)	VC (V) @IPP=1A	Ppk (W)	C (pF)	PACKAGE
	(V)	@ VRWM	@ IT					
ESD3V3AP	3.3	10	5.9	1	9.3	300	120	SOT23
ESD5V0AP	5	10	6.2		9.8	300	110	
ESD8V0AP	8	5	8.5		16.9	300	250	
ESD12VAP	12	1	13.3		19	300	60	
ESD15VAP	15	1	16.7		30	300	100	
ESD24VAP	24	1	26.7		49	300	90	
ESD36VAP	36	1	40		76.8	300	75	

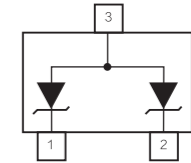

Part number	VRWM	IR (μA)	VBR (V)	IT(mA)	VC (V) @IPP=1A	Ppk (W)	C (pF)	PACKAGE
	(V)	@ VRWM	@ IT					
ESD3V3APB	3.3	40	4	1	10.5	350	220	SOT23
ESD5V0APB	5	1	6		12	300	80	
ESD8V0APB	8	1	8.5		24	350	75	
ESD12VAPB	12	1	13.3		30	300	35	
ESD15VAPB	15	1	16.7		38	350	60	
ESD24VAPB	24	1	27		45	300	25	
ESD36VAPB	36	1	38		60	300	20	
ESDLC5V0APB	5	1	5.8		10	50	15	

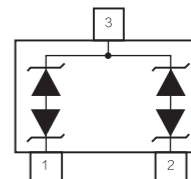

SOD923

Part number	VRWM	IR (μA)	VBR (V)	IT(mA)	VC (V) @IPP=1A	Ppk (W)	C (pF)	PACKAGE
	(V)	@ VRWM	@ IT					
ESD3V3D9	3.3	2.5	5	1	6.5	88	45	SOD-923
ESD5V0D9	5	1	6.2		9.8	107	65	
ESD12VD9	12	1	13.5		23.7	140	30	
ESDULC3V3D9	3.3	1	4.8		12	50	0.5	
ESDULC5V0D9	5	1	5.4		9.8	50	0.5	

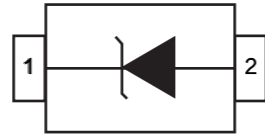

Part number	VRWM	IR (μA)	VBR (V)	IT(mA)	VC (V) @IPP=1A	Ppk (W)	C (pF)	PACKAGE
	(V)	@ VRWM	@ IT					
ESD3V3D9B	3.3	1	5.1	1	14.1	150	25	SOD-923
ESD5V0D9B	5	1	6		18.6	150	15	
ESD12V0D9B	12	1	13.8		30	150	14	
ESDULC3V3D9B	3.3	1	4.8		10	50	0.9	
ESDULC5V0D9B	5	1	5.4		12.9	50	0.9	



PACKAGE OUTLINE DIMENSIONS in millimeters (inches) :SOD923

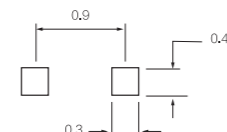
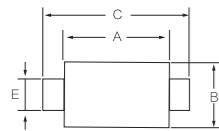

Mounting Pad Layout(mm)

Dim	Inches		Millimeters	
	MIN	MAX	MIN	MAX
A	0.030	0.033	0.75	0.85
B	0.022	0.026	0.55	0.65
C	0.037	0.041	0.95	1.05
D	0.014	0.017	0.36	0.43
E	0.006	0.010	0.15	0.25
F	0.002	0.006	0.05	0.15
H	0.003	0.007	0.07	0.17

SOT23

Part number	VRWM	IR (μA)	VBR (V)	IT(mA)	VC (V) @IPP=1A	Ppk (W)	C (pF)	PACKAGE
	(V)	@ VRWM	@ IT					
ESD3V3AP	3.3	10	5.9	1	9.3	300	120	SOT23
ESD5V0AP	5	10	6.2		9.8	300	110	
ESD8V0AP	8	5	8.5		16.9	300	250	
ESD12VAP	12	1	13.3		19	300	60	
ESD15VAP	15	1	16.7		30	300	100	
ESD24VAP	24	1	26.7		49	300	90	
ESD36VAP	36	1	40		76.8	300	75	

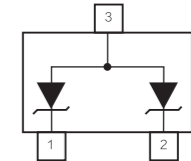

Part number	VRWM	IR (μA)	VBR (V)	IT(mA)	VC (V) @IPP=1A	Ppk (W)	C (pF)	PACKAGE
	(V)	@ VRWM	@ IT					
ESD3V3APB	3.3	40	4	1	10.5	350	220	SOT23
ESD5V0APB	5	1	6		12	300	80	
ESD8V0APB	8	1	8.5		24	350	75	
ESD12VAPB	12	1	13.3		30	300	35	
ESD15VAPB	15	1	16.7		38	350	60	
ESD24VAPB	24	1	27		45	300	25	
ESD36VAPB	36	1	38		60	300	20	
ESDLC5V0APB	5	1	5.8		10	50	15	

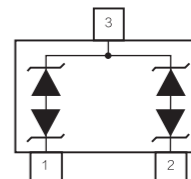

SOT23

Part number	VRWM	IR (μA)	VBR (V)	IT(mA)	VC (V) @IPP=1A	Ppk	C	PACKAGE
	(V)	@ VRWM	@ IT					
ESDSLUV2.8	2.8	1	3	1	15	400	2	SOT23

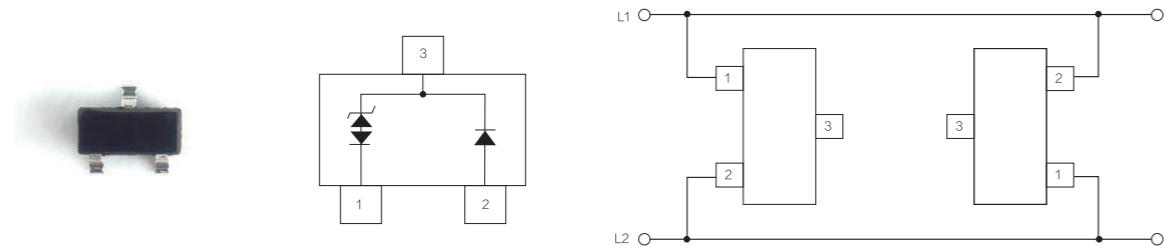

Part number		VRWM	IR (μA)	VBR (V)	IT(mA)	VC (V) @IPP=1A	Ppk	C	PACKAGE
		(V)	@ VRWM	@ IT					
ESDSM712	Pin 1 or 2 to 3	12	1	13.3	1	26	400	45	SOT23
	Pin 3 to 1 or 2	7	20	7.5					

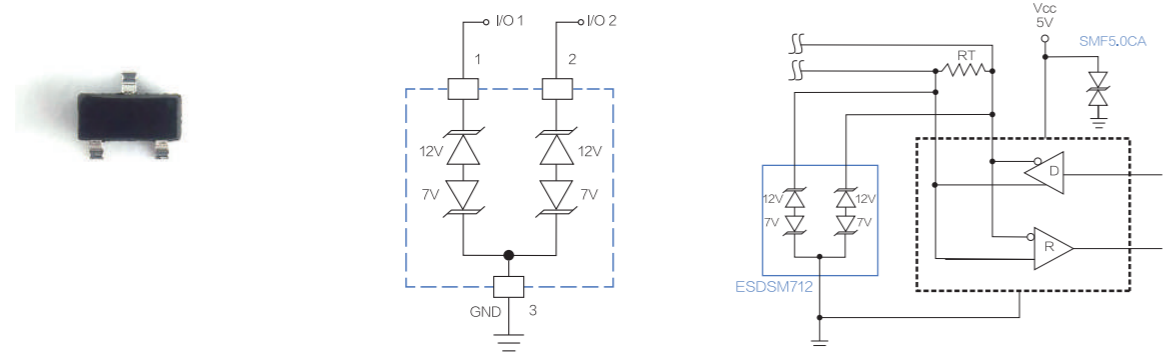

SOT23

Part number	VRWM	IR (μA)	VBR (V)	IT(mA)	VC (V) @IPP=1A	Ppk	C	PACKAGE
	(V)	@ VRWM	@ IT					
ESDSR05AP	5	1	6	1	8.5	150	1.2	SOT-23



PACKAGE OUTLINE DIMENSIONS in millimeters (inches) :SOT- 23

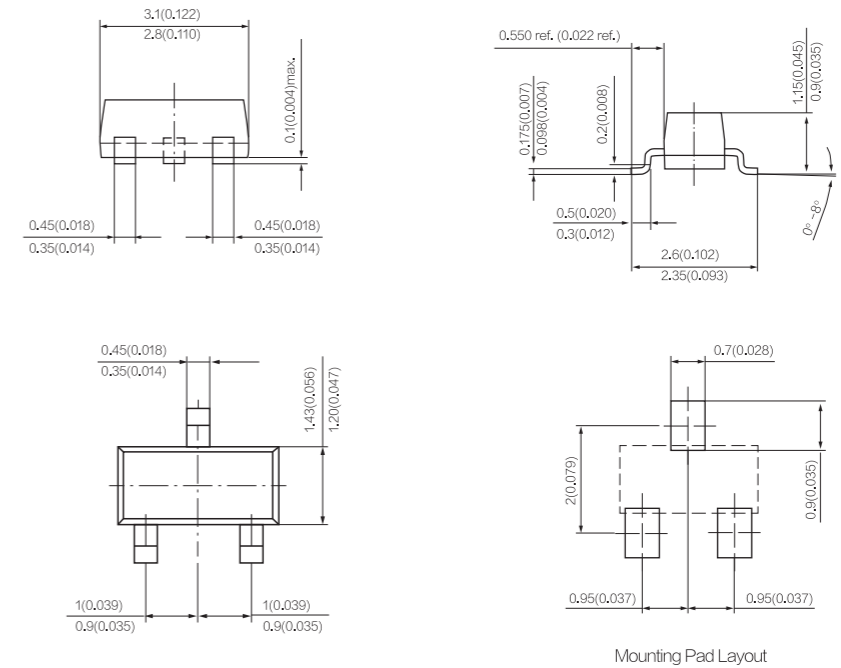

Mounting Pad Layout

SOT23

Part number	VRWM	IR (μA)	VBR (V)	IT(mA)	VC (V) @IPP=1A	Ppk	C	PACKAGE
	(V)	@ VRWM	@ IT					
ESDSLUV2.8	2.8	1	3	1	15	400	2	SOT23

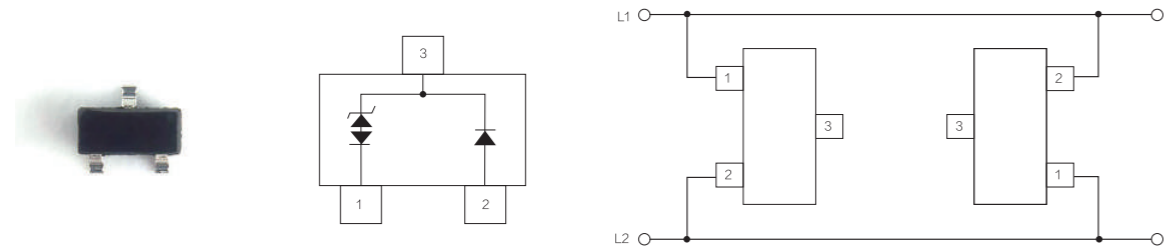

Part number		VRWM	IR (μA)	VBR (V)	IT(mA)	VC (V) @IPP=1A	Ppk	C	PACKAGE
		(V)	@ VRWM	@ IT					
ESDSM712	Pin 1 or 2 to 3	12	1	13.3	1	26	400	45	SOT23
	Pin 3 to 1 or 2	7	20	7.5					

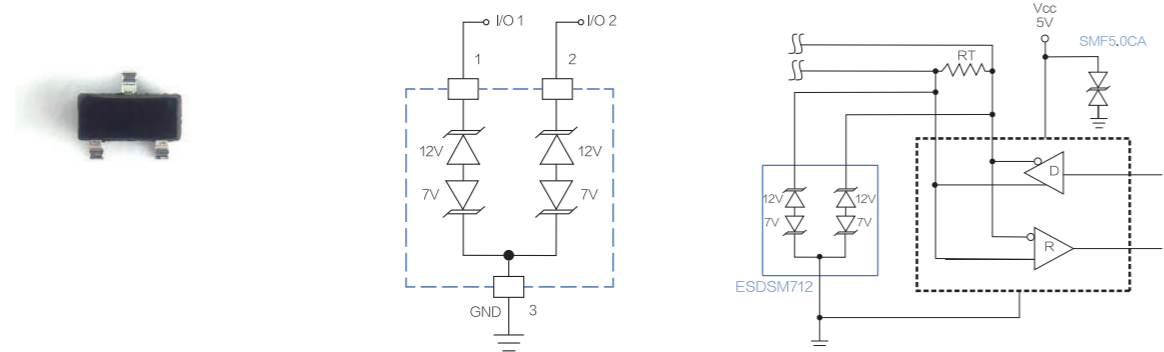

SOT23

Part number	VRWM	IR (μA)	VBR (V)	IT(mA)	VC (V) @IPP=1A	Ppk	C	PACKAGE
	(V)	@ VRWM	@ IT					
ESDSR05AP	5	1	6	1	8.5	150	1.2	SOT-23



PACKAGE OUTLINE DIMENSIONS in millimeters (inches) :SOT- 23

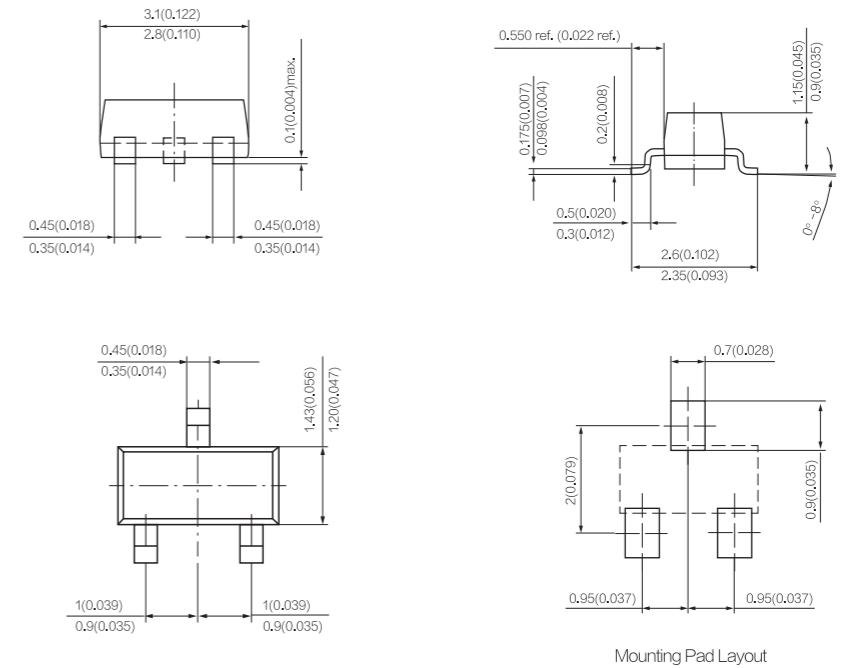

Mounting Pad Layout

DFN

Part number	VRWM	IR (μA)	VBR (V)	IT(mA)	VC (V) @IPP=1A	Ppk	C	PACKAGE
	(V)	@ VRWM	@ IT			(W)	(pF)	
ESD0524P	5	1	6	1	8.5	150	0.35	DFN-10-2.5×1.0×0.6-0.5

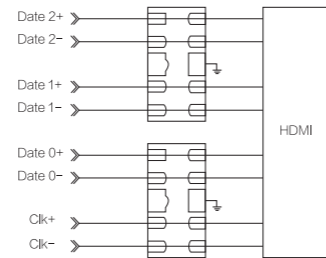
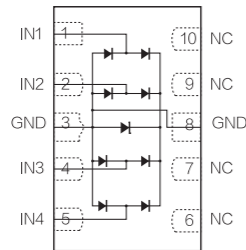

DFN-10-2.5×1.0×0.6-0.5

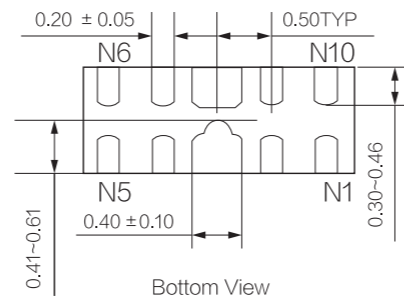
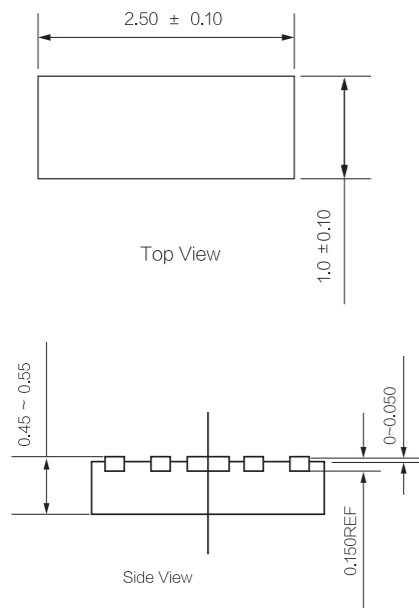

DFN

Part number	VRWM	IR (μA)	VBR (V)	IT(mA)	VC (V) @IPP=1A	Ppk	C	PACKAGE
	(V)	@ VRWM	@ IT			(W)	(pF)	
ESD3304P	3.3	1	3.8	1	12	450	3.5	DFN-10-2.5×2.5×0.6-0.5



DFN-10-2.5×2.5×0.6-0.5

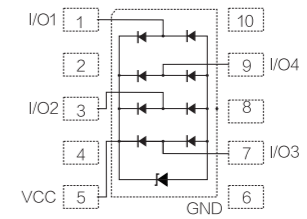

DFN-10-2.5×2.5×0.6-0.5(Top view)

DFN-10-2.5×2.5×0.6-0.5

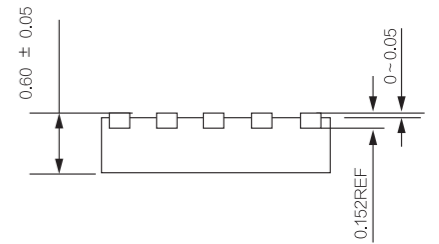
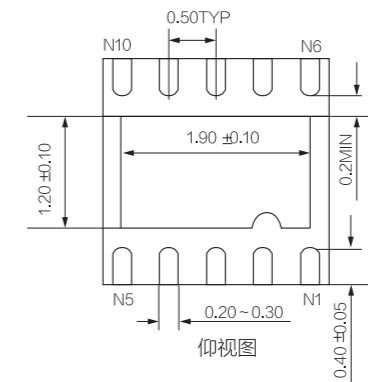
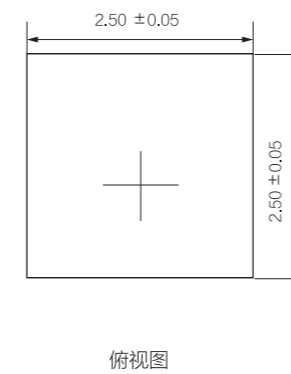

DFN

Part number	VRWM	IR (μA)	VBR (V)	IT(mA)	VC (V) @IPP=1A	Ppk	C	PACKAGE
	(V)	@ VRWM	@ IT			(W)	(pF)	
ESD0524P	5	1	6	1	8.5	150	0.35	DFN-10-2.5×1.0×0.6-0.5

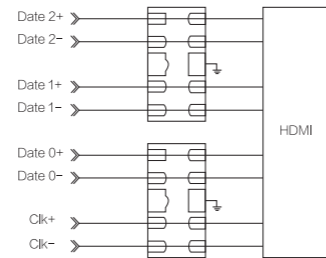
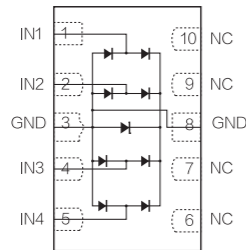

DFN-10-2.5×1.0×0.6-0.5

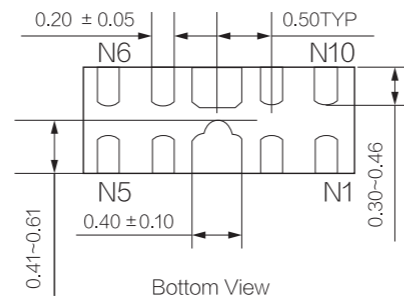
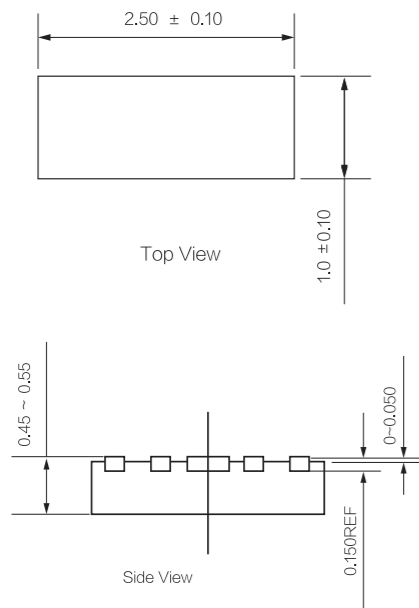

DFN

Part number	VRWM	IR (μA)	VBR (V)	IT(mA)	VC (V) @IPP=1A	Ppk	C	PACKAGE
	(V)	@ VRWM	@ IT			(W)	(pF)	
ESD3304P	3.3	1	3.8	1	12	450	3.5	DFN-10-2.5×2.5×0.6-0.5



DFN-10-2.5×2.5×0.6-0.5

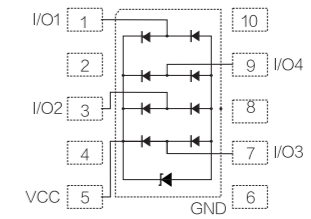

DFN-10-2.5×2.5×0.6-0.5(Top view)

DFN-10-2.5×2.5×0.6-0.5

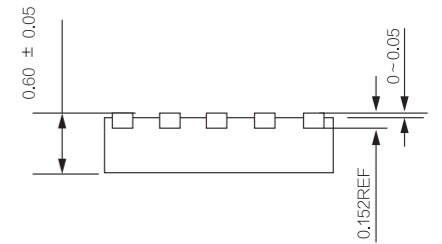
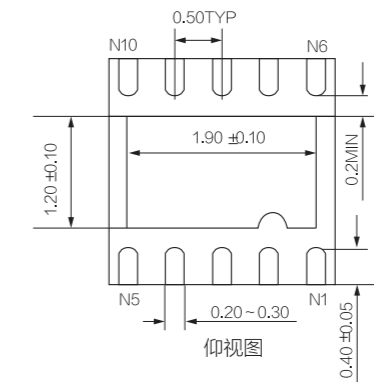
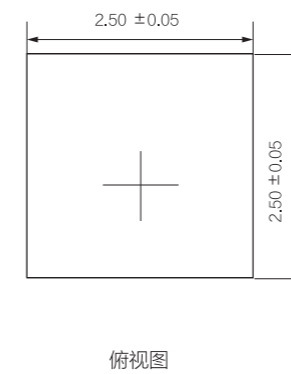

SOT-143

Part number	VRWM	IR (μA)	VBR (V)	IT(mA)	VC (V) @IPP=1A	IPP	Ppk	C	PACKAGE
	(V)	@ VRWM	@ IT			(A)	(W)	(pF)	
ESDSR05	5	5	6	1	9.8	12	500	2.5	SOT-143

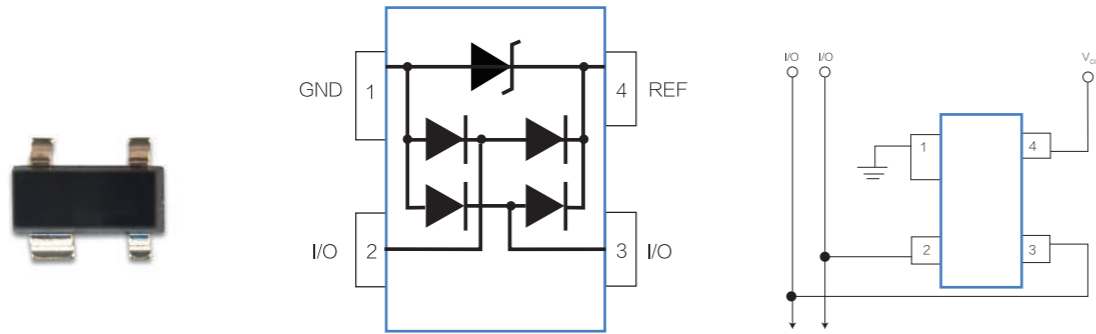

Part number	VRWM	IR (μA)	VBR (V)	IT(mA)	VC (V) @IPP=1A	IPP	Ppk	C	PACKAGE
	(V)	@ VRWM	@ IT			(A)	(W)	(pF)	
ESD5V0L3	5	5	6	1	9.8	12	100	30	SOT-143



SOT-143

Part number	VRWM	IR (μA)	VBR (V)	IT(mA)	VC (V) @IPP=1A	IPP	Ppk	C	PACKAGE
	(V)	@ VRWM	@ IT			(A)	(W)	(pF)	
ESDSR70	70	5	85	50	1.5	24	/	3	SOT-143



PACKAGE OUTLINE DIMENSIONS in inches (millimeters) SOT-143

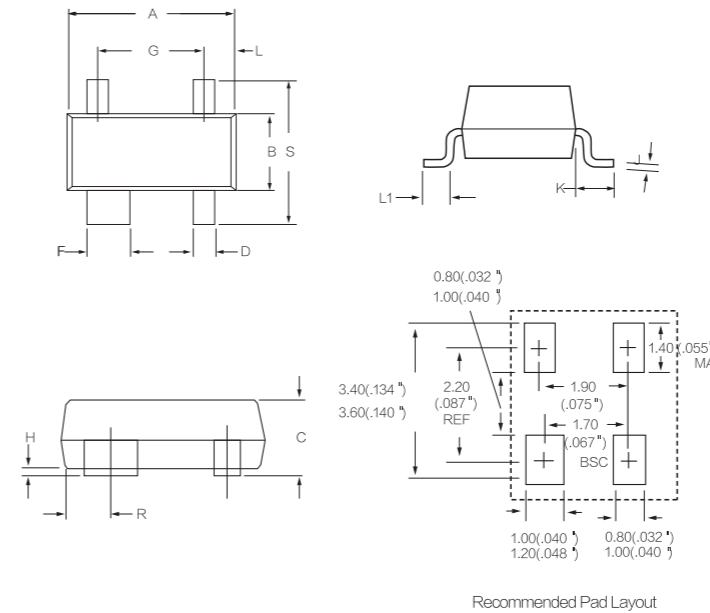

Dim	Millimeters		Inches	
	MIN	MAX	MIN	MAX
A	2.80	3.04	0.110	0.120
B	1.20	1.39	0.047	0.055
C	0.84	1.14	0.033	0.045
D	0.39	0.50	0.015	0.020
F	0.79	0.93	0.031	0.037
G	1.78	2.03	0.070	0.080
J	0.08	0.15	0.003	0.006
K	0.46	0.60	0.018	0.024
L	0.045	0.60	0.0175	0.024
L1	0.4	0.60	0.016	0.024
R	0.72	0.83	0.028	0.033
S	2.11	2.48	0.083	0.098

SOT-143

Part number	VRWM	IR (μA)	VBR (V)	IT(mA)	VC (V) @IPP=1A	IPP	Ppk	C	PACKAGE
	(V)	@ VRWM	@ IT						
ESDSR05	5	5	6	1	9.8	12	500	2.5	SOT-143

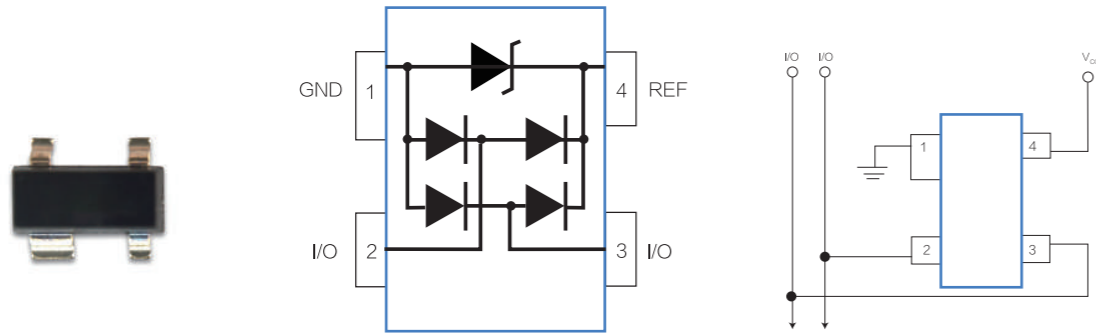

Part number	VRWM	IR (μA)	VBR (V)	IT(mA)	VC (V) @IPP=1A	IPP	Ppk	C	PACKAGE
	(V)	@ VRWM	@ IT						
ESD5V0L3	5	5	6	1	9.8	12	100	30	SOT-143



SOT-143

Part number	VRWM	IR (μA)	VBR (V)	IT(mA)	VC (V) @IPP=1A	IPP	Ppk	C	PACKAGE
	(V)	@ VRWM	@ IT						
ESDSR70	70	5	85	50	1.5	24	/	3	SOT-143

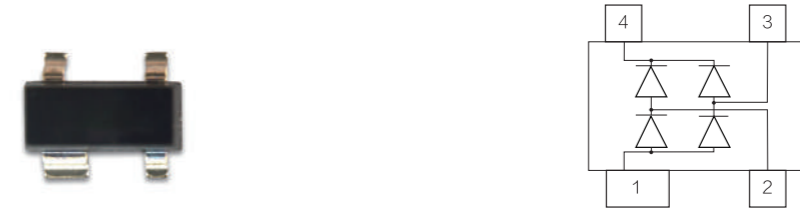

PACKAGE OUTLINE DIMENSIONS in inches (millimeters) SOT-143

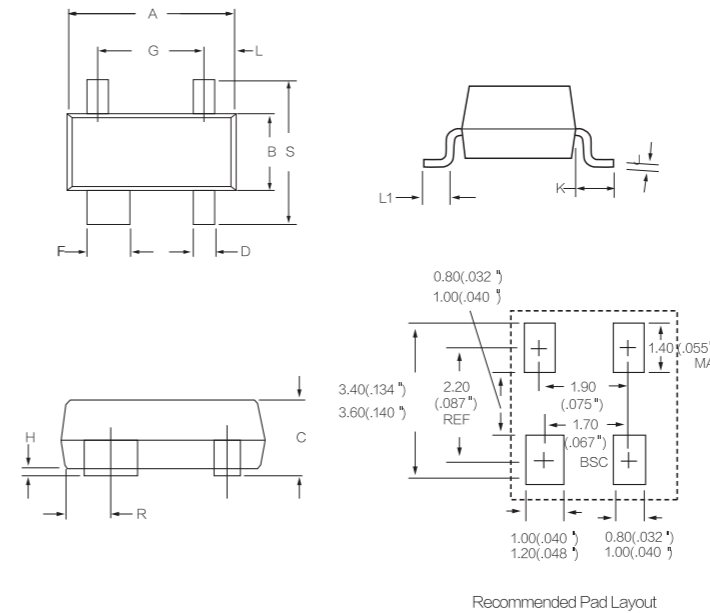

Dim	Millimeters		Inches	
	MIN	MAX	MIN	MAX
A	2.80	3.04	0.110	0.120
B	1.20	1.39	0.047	0.055
C	0.84	1.14	0.033	0.045
D	0.39	0.50	0.015	0.020
F	0.79	0.93	0.031	0.037
G	1.78	2.03	0.070	0.080
J	0.08	0.15	0.003	0.006
K	0.46	0.60	0.018	0.024
L	0.045	0.60	0.0175	0.024
L1	0.4	0.60	0.016	0.024
R	0.72	0.83	0.028	0.033
S	2.11	2.48	0.083	0.098

SOT23-6L

Part number	VRWM	IR (μA)	VBR (V)	IT(mA)	VC (V) @IPP=1A	Ppk (W)	C (pF)	PACKAGE
	(V)	@ VRWM	@ IT					
ESDSRV05-4H	5	1	6	1	12.5	350	2.5	SOT23-6L
ESDSRVLC05-4	5	1	6	1	12.5	350	0.8	

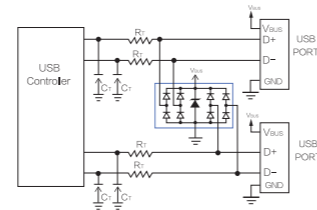
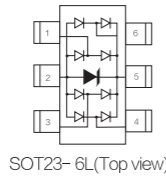

PACKAGE OUTLINE DIMENSIONS in inches (millimeters) SOT23- 6L

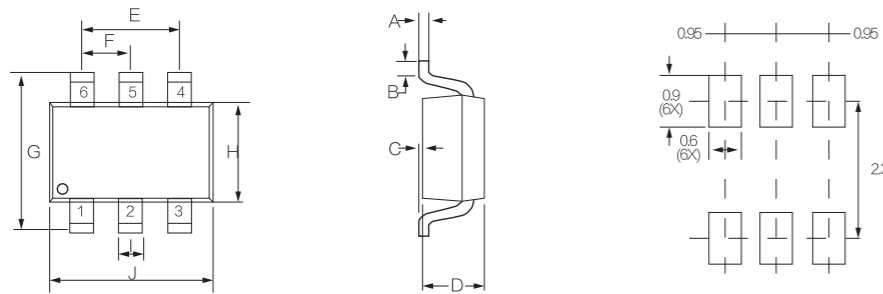

SYMBOL	DIMENSIONS			
	INCHES		MILLIMETERS	
	MIN	MAX	MIN	MAX
A	0.004	0.007	0.11	0.19
B	0.016	-	0.40	-
C	-	0.004	-	0.10
D	0.039	0.047	1.00	1.20
E	0.074	0.075	1.88	1.92
F	0.037	0.038	0.93	0.97
G	0.102	0.118	2.60	3.00
H	0.059	0.067	1.50	1.70
I	0.016	0.016	41	41
J	0.110	0.118	2.80	3.00

SOP- 8

Part number	VRWM	IR (μA)	VBR (V)	IT(mA)	VC (V) @IPP=1A	IPP (A)	Ppk (W)	C (pF)	PACKAGE
	(V)	@ VRWM	@ IT						
ESDSLUVU2.8-4	2.8	1	3	1	5.5	24	400	3	SOP- 8
ESDSMDA15C	15	1	16.7	1	30	5	500	80	
ESD3304S	3.3	1	3.8	1	12	-	450	3.5	

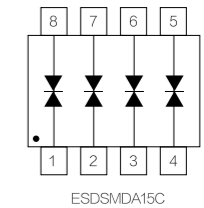
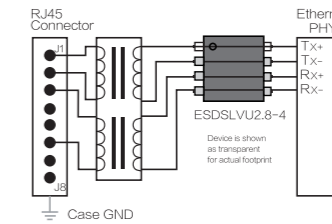
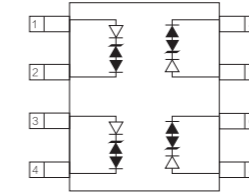

PACKAGE OUTLINE DIMENSIONS SOP-8

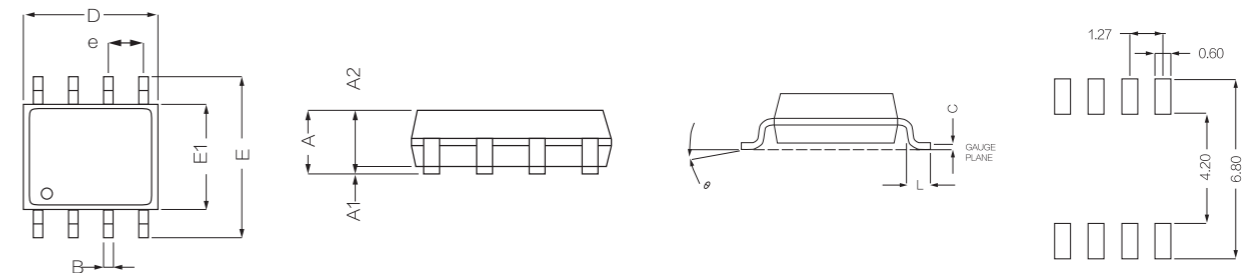

SYMBOL	DIMENSIONS			
	INCHES		MILLIMETERS	
	MIN	MAX	MIN	MAX
A	0.053	0.069	1.35	1.75
A1	0.004	0.010	0.10	0.25
A2	0.050	0.065	1.25	1.65
B	0.012	0.020	0.31	0.51
c	0.007	0.010	0.17	0.25
D	0.189	0.197	4.80	5.00
E	0.228	0.244	5.80	6.20
E1	0.150	0.157	3.80	4.00
e	0.050BSC		1.27BSC	
L	0.016	0.050	0.40	1.27

SOT23-6L

Part number	VRWM	IR (μA)	VBR (V)	IT(mA)	VC (V) @IPP=1A	Ppk (W)	C (pF)	PACKAGE
	(V)	@ VRWM	@ IT					
ESDSRV05-4H	5	1	6	1	12.5	350	2.5	SOT23-6L
ESDSRVLC05-4	5	1	6	1	12.5	350	0.8	

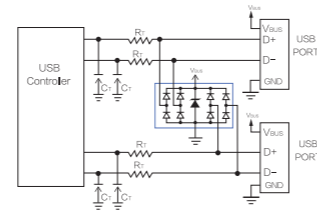
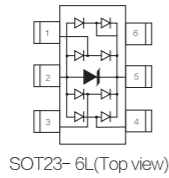

PACKAGE OUTLINE DIMENSIONS in inches (millimeters) SOT23- 6L

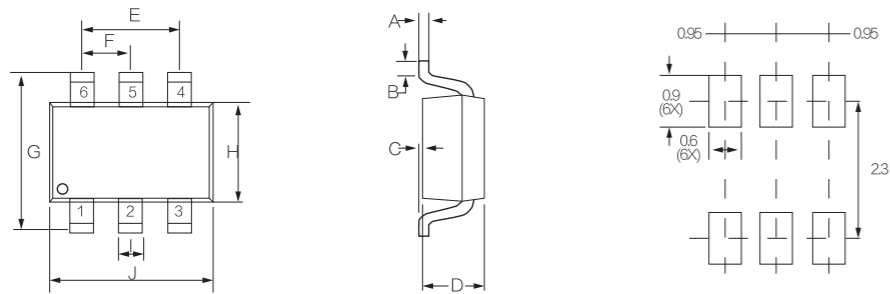

SYMBOL	DIMENSIONS			
	INCHES		MILLIMETERS	
	MIN	MAX	MIN	MAX
A	0.004	0.007	0.11	0.19
B	0.016	-	0.40	-
C	-	0.004	-	0.10
D	0.039	0.047	1.00	1.20
E	0.074	0.075	1.88	1.92
F	0.037	0.038	0.93	0.97
G	0.102	0.118	2.60	3.00
H	0.059	0.067	1.50	1.70
I	0.016	0.016	41	41
J	0.110	0.118	2.80	3.00

SOP- 8

Part number	VRWM	IR (μA)	VBR (V)	IT(mA)	VC (V) @IPP=1A	IPP (A)	Ppk (W)	C (pF)	PACKAGE
	(V)	@ VRWM	@ IT						
ESDSLUVU2.8-4	2.8	1	3	1	5.5	24	400	3	SOP- 8
ESDSMDA15C	15	1	16.7	1	30	5	500	80	
ESD3304S	3.3	1	3.8	1	12	-	450	3.5	

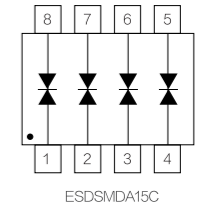
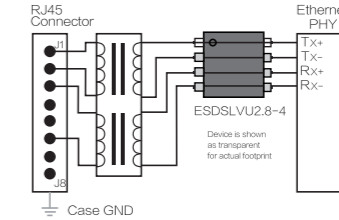
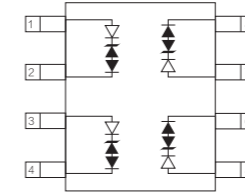

PACKAGE OUTLINE DIMENSIONS SOP-8

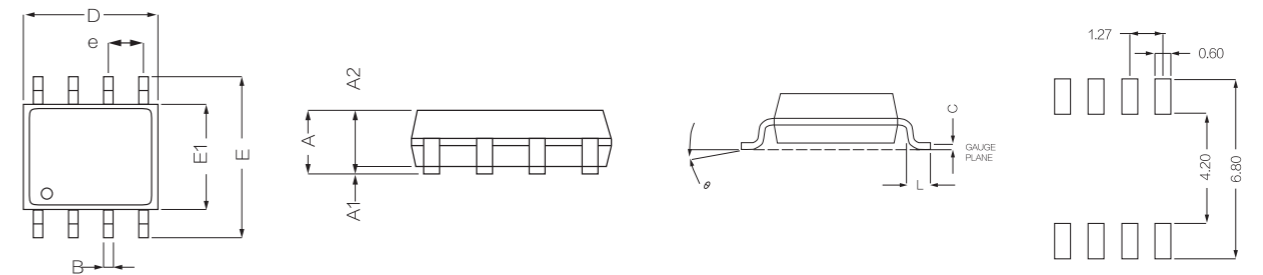

SYMBOL	DIMENSIONS			
	INCHES		MILLIMETERS	
	MIN	MAX	MIN	MAX
A	0.053	0.069	1.35	1.75
A1	0.004	0.010	0.10	0.25
A2	0.050	0.065	1.25	1.65
B	0.012	0.020	0.31	0.51
c	0.007	0.010	0.17	0.25
D	0.189	0.197	4.80	5.00
E	0.228	0.244	5.80	6.20
E1	0.150	0.157	3.80	4.00
e	0.050BSC		1.27BSC	
L	0.016	0.050	0.40	1.27

SOT-553

Part number	VRWM	IR (μA)	VBR (V)	IT(mA)	VC (V) @IPP=1A	Ppk	C	PACKAGE
	(V)	@ VRWM	@ IT			(W)	(pF)	
ESD5V0L4	5	1	6	1	9.8	20	8	SOT-553

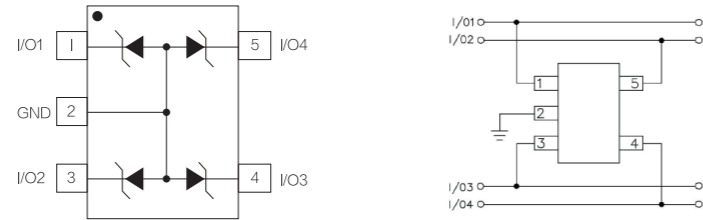

PACKAGE OUTLINE DIMENSIONS : SOT - 553

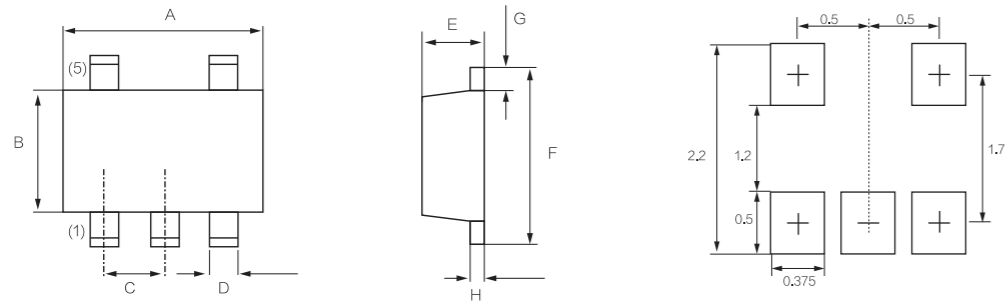

SYMBOL	DIMENSIONS			
	MILLIMETERS		INCHES	
	MIN	MAX	MIN	MAX
A	1.50	1.70	0.059	0.067
B	1.10	1.30	0.043	0.051
C	0.50BSC		0.020BSC	
D	0.17	0.27	0.007	0.011
E	0.50	0.60	0.020	0.024
F	1.50	1.70	0.059	0.067
G	0.10	0.30	0.004	0.012
H	0.08	0.16	0.003	0.006

SOT-353

Part number	VRWM	IR (μA)	VBR (V)	IT(mA)	VC (V) @IPP=1A	Ppk	C	PACKAGE
	(V)	@ VRWM	@ IT			(W)	(pF)	
ESD3V0J4	3	1	5.3	1	8	20	9	SOT-353
ESD5V0J4	5	5	6	1	12	60	30	SOT-353

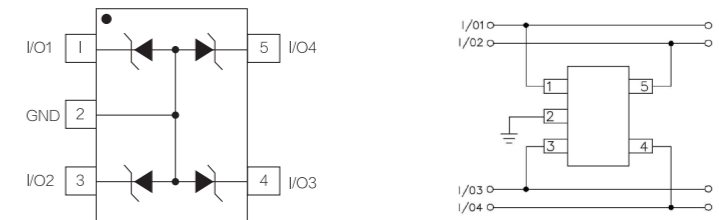

PACKAGE OUTLINE DIMENSIONS : SOT— 353

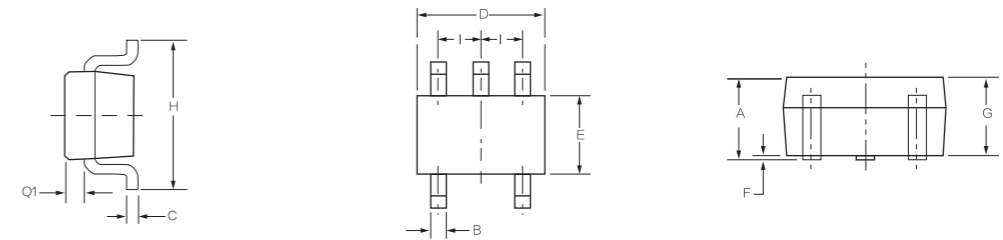

SYMBOL	DIMENSIONS			
	INCHES		MILLIMETERS	
	MIN	MAX	MIN	MAX
A	0.80	1.10	0.031	0.043
B	0.15	0.30	0.006	0.012
C	0.10	0.18	0.004	0.007
D	1.80	2.20	0.071	0.087
E	1.15	1.35	0.045	0.053
F	0.10		0.004	
G	0.80	1.00	0.031	0.039
H	1.80	2.40	0.071	0.094
I	0.65		0.026	
Q1	0.10	0.40	0.004	0.016

SOT-553

Part number	VRWM	IR (μA)	VBR (V)	IT(mA)	VC (V)	Ppk	C	PACKAGE
	(V)	@ VRWM	@ IT		@IPP=1A			
ESD5V0L4	5	1	6	1	9.8	20	8	SOT-553

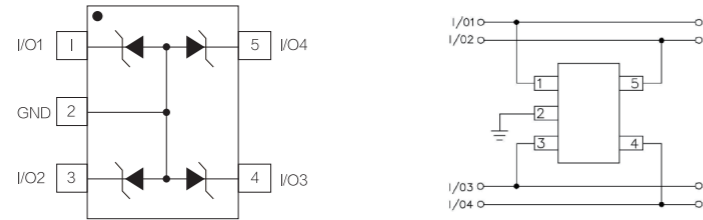

PACKAGE OUTLINE DIMENSIONS : SOT - 553

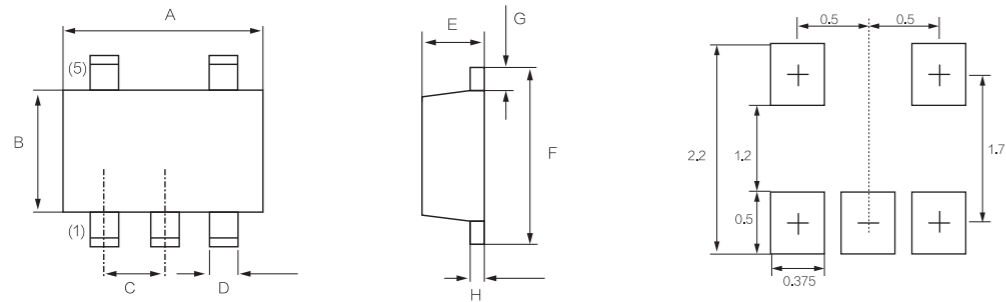

SYMBOL	DIMENSIONS			
	MILLIMETERS		INCHES	
	MIN	MAX	MIN	MAX
A	1.50	1.70	0.059	0.067
B	1.10	1.30	0.043	0.051
C	0.50BSC		0.020BSC	
D	0.17	0.27	0.007	0.011
E	0.50	0.60	0.020	0.024
F	1.50	1.70	0.059	0.067
G	0.10	0.30	0.004	0.012
H	0.08	0.16	0.003	0.006

SOT-353

Part number	VRWM	IR (μA)	VBR (V)	IT(mA)	VC (V)	Ppk	C	PACKAGE
	(V)	@ VRWM	@ IT		@IPP=1A			
ESD3V0J4	3	1	5.3	1	8	20	9	SOT-353
ESD5V0J4	5	5	6	1	12	60	30	SOT-353

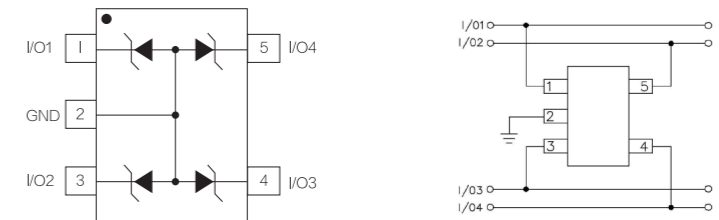

PACKAGE OUTLINE DIMENSIONS : SOT— 353

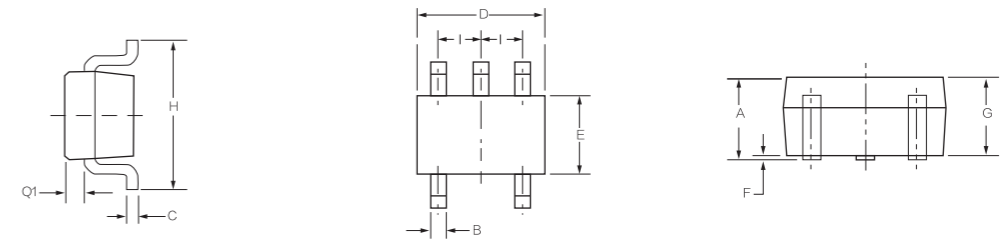

SYMBOL	DIMENSIONS			
	INCHES		MILLIMETERS	
	MIN	MAX	MIN	MAX
A	0.80	1.10	0.031	0.043
B	0.15	0.30	0.006	0.012
C	0.10	0.18	0.004	0.007
D	1.80	2.20	0.071	0.087
E	1.15	1.35	0.045	0.053
F	0.10		0.004	
G	0.80	1.00	0.031	0.039
H	1.80	2.40	0.071	0.094
I	0.65		0.026	
Q1	0.10	0.40	0.004	0.016

SOT-563

Part number	VRWM	IR (μA)	VBR (V)	IT(mA)	VC (V) @IPP=1A	Ppk	C	PACKAGE
	(V)	@ VRWM	@ IT			(W)	(pF)	
ESD5V0M5	5	5	6	1	12	60	30	SOT-563

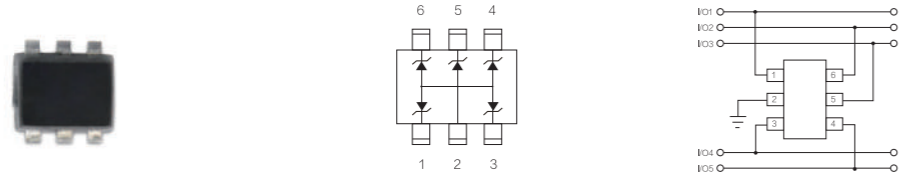

PACKAGE OUTLINE DIMENSIONS in millimeters (inches) :SOT-563

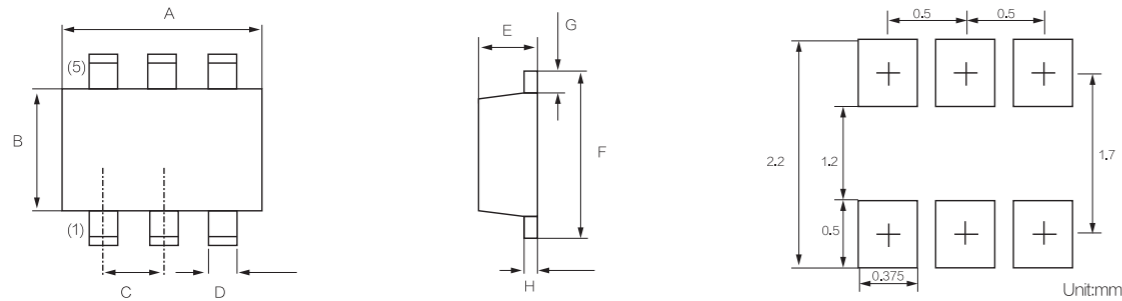

SYMBOL	DIMENSIONS			
	MILLIMETERS		INCHES	
	MIN	MAX	MIN	MAX
A	1.50	1.70	0.059	0.067
B	1.10	1.30	0.043	0.051
C	0.50BSC		0.020BSC	
D	0.17	0.27	0.007	0.011
E	0.50	0.60	0.020	0.024
F	1.50	1.70	0.059	0.067
G	0.10	0.30	0.004	0.012
H	0.08	0.16	0.003	0.006

SOT-363

Part number	VRWM	IR (μA)	VBR (V)	IT(mA)	VC (V) @IPP=1A	Ppk	C	PACKAGE
	(V)	@ VRWM	@ IT			(W)	(pF)	
ESD5V0K5	5	5	6	1	12	60	30	SOT-363
ESDULC5V-4K5	5	1	6	1	20	100	0.8	SOT-363

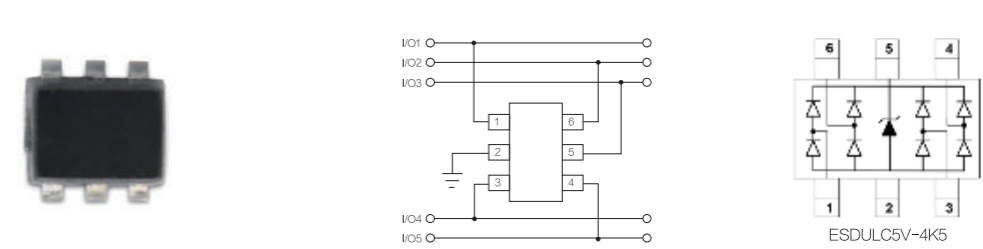

PACKAGE OUTLINE DIMENSIONS : SOT-363

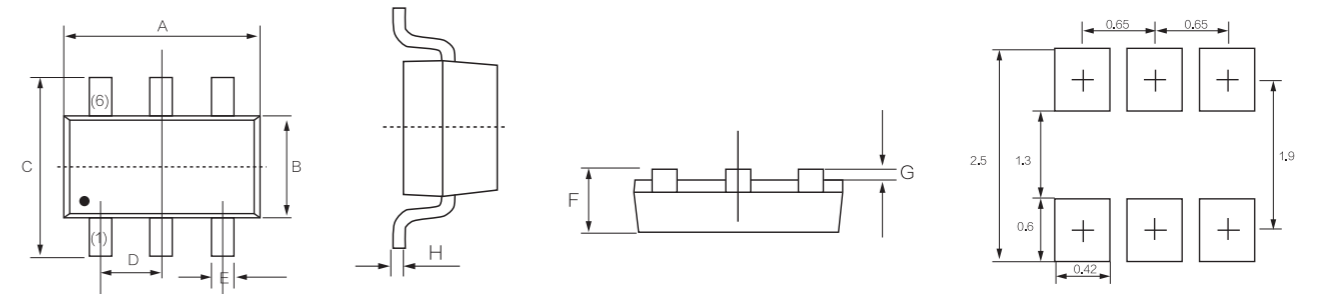

SYMBOL	DIMENSIONS			
	MILLIMETERS		INCHES	
	MIN	MAX	MIN	MAX
A	2.0	2.2	0.079	0.087
B	1.15	1.35	0.045	0.053
C	2.15	2.45	0.085	0.096
D	0.65BSC		0.026BSC	
E	0.15	0.35	0.006	0.014
F	0.90	1.10	0.035	0.043
G	0.00	0.10	0.000	0.004
H	0.08	0.15	0.003	0.006

SOT-563

Part number	VRWM	IR (μA)	VBR (V)	IT(mA)	VC (V) @IPP=1A	Ppk	C	PACKAGE
	(V)	@ VRWM	@ IT			(W)	(pF)	
ESD5V0M5	5	5	6	1	12	60	30	SOT-563

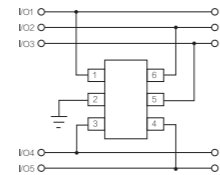
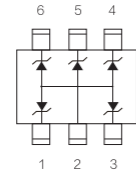

PACKAGE OUTLINE DIMENSIONS in millimeters (inches) :SOT-563

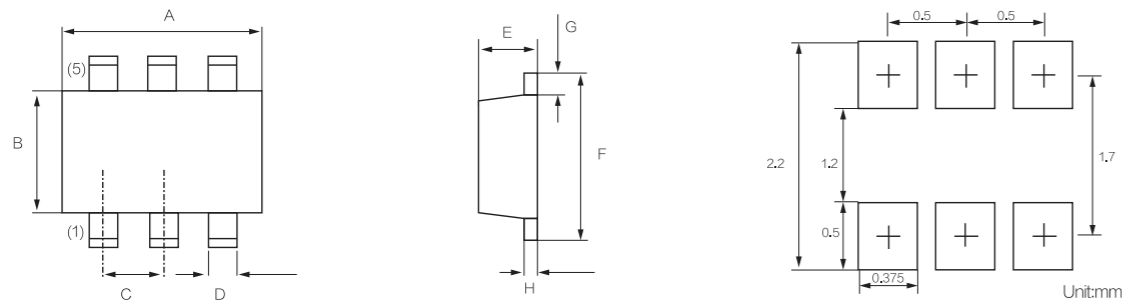

SYMBOL	DIMENSIONS			
	MILLIMETERS		INCHES	
	MIN	MAX	MIN	MAX
A	1.50	1.70	0.059	0.067
B	1.10	1.30	0.043	0.051
C	0.50BSC		0.020BSC	
D	0.17	0.27	0.007	0.011
E	0.50	0.60	0.020	0.024
F	1.50	1.70	0.059	0.067
G	0.10	0.30	0.004	0.012
H	0.08	0.16	0.003	0.006

SOT-363

Part number	VRWM	IR (μA)	VBR (V)	IT(mA)	VC (V) @IPP=1A	Ppk	C	PACKAGE
	(V)	@ VRWM	@ IT			(W)	(pF)	
ESD5V0K5	5	5	6	1	12	60	30	SOT-363
ESDULC5V-4K5	5	1	6	1	20	100	0.8	SOT-363

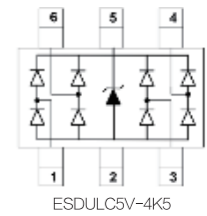
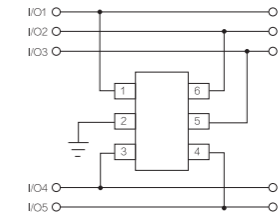

PACKAGE OUTLINE DIMENSIONS : SOT-363

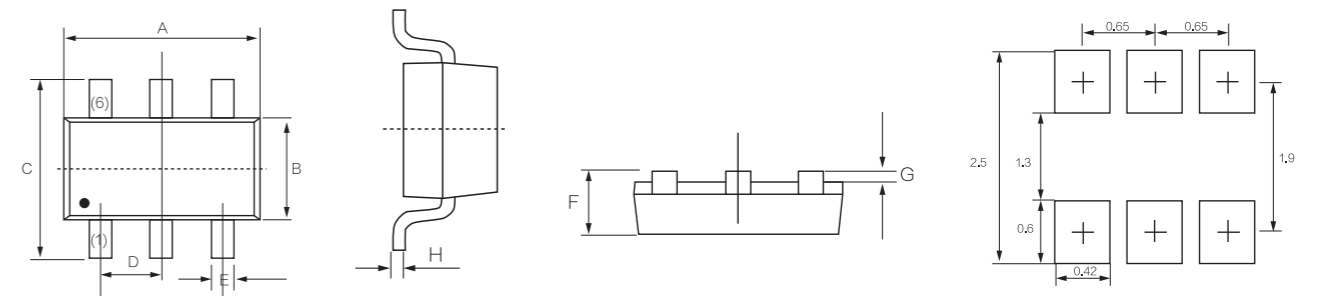

SYMBOL	DIMENSIONS			
	MILLIMETERS		INCHES	
	MIN	MAX	MIN	MAX
A	2.0	2.2	0.079	0.087
B	1.15	1.35	0.045	0.053
C	2.15	2.45	0.085	0.096
D	0.65BSC		0.026BSC	
E	0.15	0.35	0.006	0.014
F	0.90	1.10	0.035	0.043
G	0.00	0.10	0.000	0.004
H	0.08	0.15	0.003	0.006

SMD

Scope

This specification is applied to electrostatic discharge (ESD) protection. It is designed to protect the high-speed data lines against ESD transients. It has very low capacitance and fast turn on times makes it ideal for data and transmission lines with high data rates. According to the special property of device, we recommend not to use on such application as: DC/AC power line. For RoHS Compliance.

Features

- ▲ Protection against ESD voltages and currents (IEC61000- 4- 2 Level 4)
- ▲ Extremely quick response time (<1ns) present ideal ESD protection
- ▲ Extremely low capacitance (0.2pF typical)
- ▲ Extremely low leakage current
- ▲ Bi-directional device
- ▲ SMD (Surface Mount Device)
- ▲ Zero signal distortion
- ▲ For RoHS Compliance

Product Model

- ▲ Digital Video Equipment
- ▲ Mobile Phone
- ▲ GPS Antenna
- ▲ Bluetooth Communication Equipment

Applications

- ▲ Antenna circuit
- ▲ USB2.0/3.0
- ▲ IEEE-1394
- ▲ DVI
- ▲ HDMI

Circuit symbol



Part number	PACKAGE	Rated voltage(V)	Leakage current(μA)	Trigger voltage(V)	Clamping voltage(V)	C @1MHz
PGB0201-05	0201	5	0.01	250	30	0.2
PGB0402-05	0402	5	0.01	300	30	0.2
PGB0402-12	0402	12	0.01	300	30	0.2
PGB0402-24	0402	24	0.01	300	30	0.2
PGB0603-05	0603	5	0.01	300	30	0.2
PGB0603-12	0603	12	0.01	300	30	0.2
PGB0603-24	0603	24	0.01	300	30	0.2

半导体放电管 TSS (Thyristor Surge Suppressors)

TSS是一种PNPN型的器件，可以看作一个没有门极的晶闸管。当一个浪涌电压超过TSS的关断电压时（VDRM），TSS将电压限制在转折电压以下，这时，当通过TSS的电流超过开关电流，TSS将处于短路的状态。当通过TSS的电流低于去维持电流IH，TSS将重置恢复到高阻抗状态。

TSS is a PNP type device that can be regarded as a thyristor without a gate. When a surge voltage exceeds the peak off-state voltage of TSS (VDRM), TSS limits the voltage below the break-over voltage. At this time, When the current flowing through TSS exceeds the switching current, the TSS will be in a short-circuit condition. When the current flowing through TSS lower than the holding current (IH), the TSS will reset to a high-impedance state.

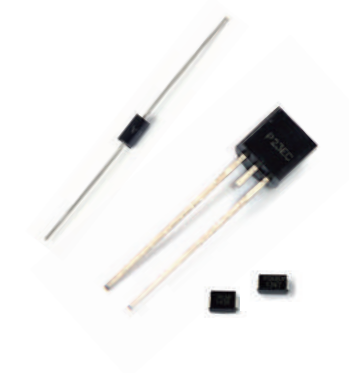

TSS

应用注意 Restrictions

因为TSS是一个开关型的器件，故不能直接在AC线上使用，他必须放在负载后面，如果不这样做，将会导致TSS击穿损坏。

Because the TSS device is a crowbar device, it cannot be used directly across the AC line; it must be placed behind a load. Failing to do so will result in exceeding the TSS device's maximum on-state current rating, which may cause the device to enter a permanent short-circuit condition.

特点 Advantages

响应速度快，电气特性稳定，高可靠性，低电容，并且因为TSS是一个开关型器件，他不会被过电压损坏。

Advantages of the TSS device include its fast response time, stable electrical characteristics, long term reliability, and low capacitance. Also, because the TSS device is a crowbar device, it cannot be damaged by voltage.

应用 Applications

TSS主要应用于电信行业和数据通信的过压保护，其他领域的应用，应该参考TSS选型指南。

TSS devices are primarily used as the principle overvoltage protector in telecommunications and data communications circuits. For applications outside this realm, follow the design criteria in "TSS Device Selection Criteria".

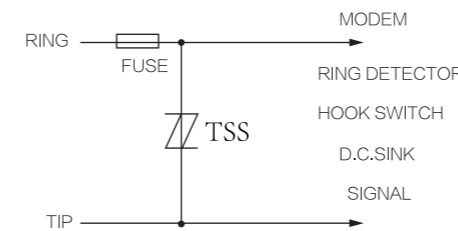

Modem Inter-wire Protection

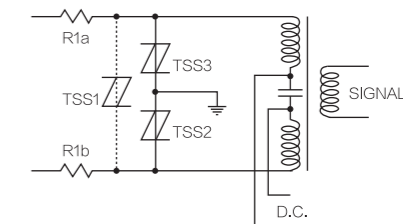

ISDN Protection

SMD

Scope

This specification is applied to electrostatic discharge (ESD) protection. It is designed to protect the high-speed data lines against ESD transients. It has very low capacitance and fast turn on times makes it ideal for data and transmission lines with high data rates. According to the special property of device, we recommend not to use on such application as: DC/AC power line. For RoHS Compliance.

Features

- ▲ Protection against ESD voltages and currents (IEC61000- 4- 2 Level 4)
- ▲ Extremely quick response time (<1ns) present ideal ESD protection
- ▲ Extremely low capacitance (0.2pF typical)
- ▲ Extremely low leakage current
- ▲ Bi-directional device
- ▲ SMD (Surface Mount Device)
- ▲ Zero signal distortion
- ▲ For RoHS Compliance

Product Model

- ▲ Digital Video Equipment
- ▲ Mobile Phone
- ▲ GPS Antenna
- ▲ Bluetooth Communication Equipment

Applications

- ▲ Antenna circuit
- ▲ USB2.0/3.0
- ▲ IEEE-1394
- ▲ DVI
- ▲ HDMI

Circuit symbol



Part number	PACKAGE	Rated voltage(V)	Leakage current(μA)	Trigger voltage(V)	Clamping voltage(V)	C @1MHz
PGB0201-05	0201	5	0.01	250	30	0.2
PGB0402-05	0402	5	0.01	300	30	0.2
PGB0402-12	0402	12	0.01	300	30	0.2
PGB0402-24	0402	24	0.01	300	30	0.2
PGB0603-05	0603	5	0.01	300	30	0.2
PGB0603-12	0603	12	0.01	300	30	0.2
PGB0603-24	0603	24	0.01	300	30	0.2

半导体放电管 TSS (Thyristor Surge Suppressors)

TSS是一种PNPN型的器件，可以看作一个没有门极的晶闸管。当一个浪涌电压超过TSS的关断电压时（VDRM），TSS将电压限制在转折电压以下，这时，当通过TSS的电流超过开关电流，TSS将处于短路的状态。当通过TSS的电流低于去维持电流IH，TSS将重置恢复到高阻抗状态。

TSS is a PNP type device that can be regarded as a thyristor without a gate. When a surge voltage exceeds the peak off-state voltage of TSS (VDRM), TSS limits the voltage below the break-over voltage. At this time, When the current flowing through TSS exceeds the switching current, the TSS will be in a short-circuit condition. When the current flowing through TSS lower than the holding current (IH), the TSS will reset to a high-impedance state.

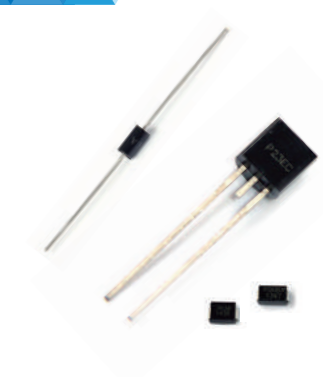

TSS

应用注意 Restrictions

因为TSS是一个开关型的器件，故不能直接在AC线上使用，他必须放在负载后面，如果不这样做，将会导致TSS击穿损坏。

Because the TSS device is a crowbar device, it cannot be used directly across the AC line; it must be placed behind a load. Failing to do so will result in exceeding the TSS device's maximum on-state current rating, which may cause the device to enter a permanent short-circuit condition.

特点 Advantages

响应速度快，电气特性稳定，高可靠性，低电容，并且因为TSS是一个开关型器件，他不会被过电压损坏。

Advantages of the TSS device include its fast response time, stable electrical characteristics, long term reliability, and low capacitance. Also, because the TSS device is a crowbar device, it cannot be damaged by voltage.

应用 Applications

TSS主要应用于电信行业和数据通信的过压保护，其他领域的应用，应该参考TSS选型指南。

TSS devices are primarily used as the principle overvoltage protector in telecommunications and data communications circuits. For applications outside this realm, follow the design criteria in "TSS Device Selection Criteria".

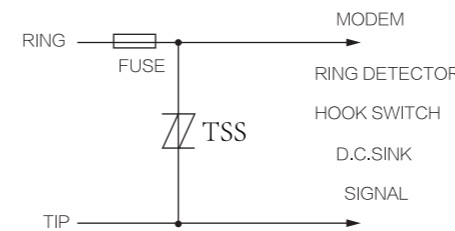

Modem Inter-wire Protection

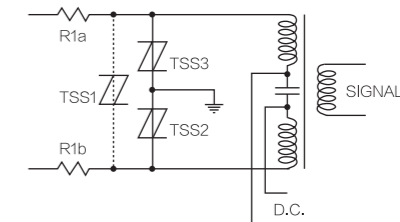

ISDN Protection

V-I Characteristics

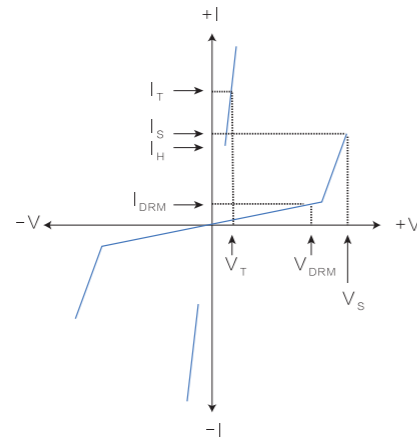

V_{DRM}	Peak Off-state Voltage: maximum voltage that can be applied while maintaining off state. The V _{DRM} of the TSS device must be greater than the maximum operating voltage of the circuit that the TSS device is protecting.	最大关断电压	使TSS保持关断状态的最大电压。V _{DRM} 必须大于被保护电路的最大操作电压。
V_S	Switching Voltage: maximum voltage prior to switching to on state. The V _S of the TSS device should be equal to or less than the instantaneous peak voltage rating of the component it is protecting.	转折电压	使TSS切换到导通状态的最大电压。TSS的V _S 必须大于被保护设备能够耐受的瞬时峰值电压。
V_T	On-state Voltage: maximum voltage measured at rated on-state current.	通态电压	TSS处于导通状态是两端的最大电压
I_{DRM}	Leakage Current: maximum peak off-state current measured at V _{DRM}	漏电流	TSS处于关断状态时的最大漏电流
I_S	Switching Current: maximum current required to switch to on state	转折电流	TSS切换到导通状态所需的最大电流。
I_T	On-state Current: maximum rated continuous on-state current	通态电流	最大连续通态电流
I_H	Holding Current: minimum current required to maintain on state. Because TIA-968-A 4.4.1.7.3 specifies that registered terminal equipment not exceed 140 mA dc per conductor under short-circuit conditions, the holding current of the TSS device is set at 150 mA. For specific design criteria, the holding current (I _H) of the TSS device must be greater than the DC current that can be supplied during an operational and short circuit condition.	保持电流	使TSS维持在导通状态的最小电流。因为TIA-968-A 4.4.1.7.3指定终端设备的半导体短路状态下电流不能超过140mA, 故TSS的保持电流设置在150mA。特定的设计标准TSS的I _H 必须大于DC供电端操作和短路, 特定的设计标准TSS的I _H 必须大于DC供电端操作和短路电流。
C_o	Off-state Capacitance: typical capacitance measured in off state. Assuming that the critical point of insertion loss is 70 percent of the original signal value, the TSS device can be used in most applications with transmission speeds up to 30 MHz.	关断状态下电容	关断状态下测量的典型电容。假定插入损耗关断状态下测量的典型电容。假定插入损耗的临界点是70%原始信号值, TSS最多可以应用于30MHz的信号线上
I_{PP}	Peak Pulse Current: maximum rated peak impulse current. For circuits that do not require additional series resistance, the surge current rating (I _{PP}) of the TSS device should be greater than or equal to the surge currents associated with the lightning immunity tests of the applicable regulatory requirement (IPK). For circuits that use additional series resistance, the surge current rating (I _{PP}) of the TSS device should be greater than or equal to the available surge currents associated with the lightning immunity tests of the applicable regulatory requirement (IPK(available))	脉冲峰值电流	TSS能承受的最大脉冲峰值电流对于不需要额外串连电阻的电路, TSS的I _{PP} 必须大于等于相关标准要求大于等于放浪涌测试时实际的电流。

SOD-123FL----DA Series

Surge Ratings

Series	I _{pp} 2/10μS Amps	I _{pp} 8/20μS Amps	I _{pp} 10/160μS Amps	I _{pp} 10/560μS Amps	I _{pp} 10/1000μS Amps	I _{TSM} 60HZ Amps	Di/Dt Amps /μS
SOD-123 /DA	150	150	90	50	45	20	500

Parameter Description		I _{DRM} @V _{DRM}		V _S ^① @I _S		V _T @I _T		I _H	C _O ^②
Unit		μA	V	V	mA	V	A	mA	pF
Type	ENV	max	min	max	max	max	max	min	max
P0080DA	L	5	6	25	800	4	2.2	50	80
P0220DA	L	5	15	32	800	4	2.2	50	60
P0300DA	L	5	25	40	800	4	2.2	50	60
P0640DA	L	5	58	77	800	4	2.2	150	50
P0720DA	L	5	65	87	800	4	2.2	150	50
P0900DA	L	5	75	98	800	4	2.2	150	50
P1100DA	L	5	90	130	800	4	2.2	150	45
P1300DA	L	5	120	160	800	4	2.2	150	45
P1500DA	L	5	140	180	800	4	2.2	150	45
P1800DA	L	5	170	220	800	4	2.2	150	35
P2300DA	L	5	190	260	800	4	2.2	150	35
P2600DA	L	5	220	300	800	4	2.2	150	35
P3100DA	L	5	275	350	800	4	2.2	150	35
P3500DA	L	5	320	400	800	4	2.2	150	35

L : Lead-free
 ①V_S is measured at 100KV/s
 ②Off-state capacitance is measured in V_{DC}=2V, V_{RMS}=1V, f=1MHz

PACKAGE OUTLINE DIMENSIONS in inches (millimeters)

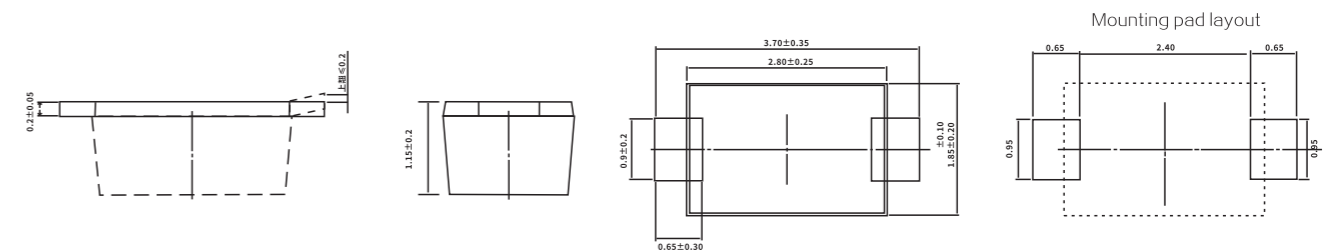

TSS

V-I Characteristics

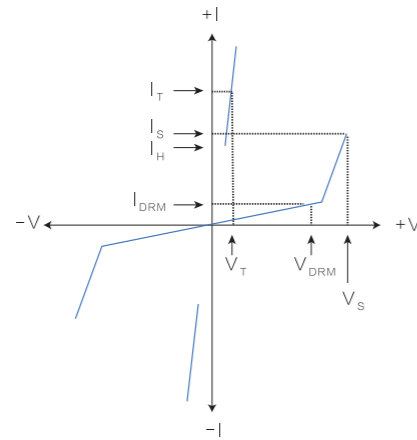

V_{DRM}	Peak Off-state Voltage: maximum voltage that can be applied while maintaining off state. The V_{DRM} of the TSS device must be greater than the maximum operating voltage of the circuit that the TSS device is protecting.	最大关断电压	使TSS保持关断状态的最大电压。VDRM必须大于被保护电路的最大操作电压。
V_S	Switching Voltage: maximum voltage prior to switching to on state. The V_S of the TSS device should be equal to or less than the instantaneous peak voltage rating of the component it is protecting.	转折电压	使TSS切换到导通状态的最大电压。TSS的 V_S 必须大于被保护设备能够耐受的瞬时峰值电压。
V_T	On-state Voltage: maximum voltage measured at rated on-state current.	通态电压	TSS处于导通状态是两端的最大电压
I_{DRM}	Leakage Current: maximum peak off-state current measured at V_{DRM}	漏电流	TSS处于关断状态时的最大漏电流
I_S	Switching Current: maximum current required to switch to on state	转折电流	TSS切换到导通状态所需的最大电流。
I_T	On-state Current: maximum rated continuous on-state current	通态电流	最大连续通态电流
I_H	Holding Current: minimum current required to maintain on state. Because TIA-968-A 4.4.1.7.3 specifies that registered terminal equipment not exceed 140 mA dc per conductor under short-circuit conditions, the holding current of the TSS device is set at 150 mA. For specific design criteria, the holding current (I_H) of the TSS device must be greater than the DC current that can be supplied during an operational and short circuit condition.	保持电流	使TSS维持在导通状态的最小电流。因为TIA-968-A 4.4.1.7.3指定终端设备的半导体短路状态下电流不能超过140mA, 故TSS的保持电流设置在150mA。特定的设计标准TSS的 I_H 必须大于DC供电端操作和短路, 特定的设计标准TSS的 I_H 必须大于DC供电端操作和短路电流。
C_o	Off-state Capacitance: typical capacitance measured in off state. Assuming that the critical point of insertion loss is 70 percent of the original signal value, the TSS device can be used in most applications with transmission speeds up to 30 MHz.	关断状态下电容	关断状态下测量的典型电容。假定插入损耗关断状态下测量的临界点是70%原始信号值, TSS最多可以应用于30MHz的信号线上
I_{PP}	Peak Pulse Current: maximum rated peak impulse current. For circuits that do not require additional series resistance, the surge current rating (I_{PP}) of the TSS device should be greater than or equal to the surge currents associated with the lightning immunity tests of the applicable regulatory requirement (I_{PK}). For circuits that use additional series resistance, the surge current rating (I_{PP}) of the TSS device should be greater than or equal to the available surge currents associated with the lightning immunity tests of the applicable regulatory requirement (I_{PK} (available))	脉冲峰值电流	TSS能承受的最大脉冲峰值电流对于不需要额外串连电阻的电路, TSS的 I_{PP} 必须大于等于相关标准要求大于等于放浪涌测试时实际的电流。

SOD-123FL----DA Series

Surge Ratings

Series	I_{pp} 2/10 μ S Amps	I_{pp} 8/20 μ S Amps	I_{pp} 10/160 μ S Amps	I_{pp} 10/560 μ S Amps	I_{pp} 10/1000 μ S Amps	I_{TSM} 60HZ Amps	Dt/Dt Amps / μ S
SOD-123 /DA	150	150	90	50	45	20	500

Parameter Description		$I_{DRM}@V_{DRM}$		$V_S^1 @I_S$		$V_T @ I_T$		I_H	C_O^2
Unit		μ A	V	V	mA	V	A	mA	pF
Type	ENV	max	min	max	max	max	max	min	max
P0080DA	L	5	6	25	800	4	2.2	50	80
P0220DA	L	5	15	32	800	4	2.2	50	60
P0300DA	L	5	25	40	800	4	2.2	50	60
P0640DA	L	5	58	77	800	4	2.2	150	50
P0720DA	L	5	65	87	800	4	2.2	150	50
P0900DA	L	5	75	98	800	4	2.2	150	50
P1100DA	L	5	90	130	800	4	2.2	150	45
P1300DA	L	5	120	160	800	4	2.2	150	45
P1500DA	L	5	140	180	800	4	2.2	150	45
P1800DA	L	5	170	220	800	4	2.2	150	35
P2300DA	L	5	190	260	800	4	2.2	150	35
P2600DA	L	5	220	300	800	4	2.2	150	35
P3100DA	L	5	275	350	800	4	2.2	150	35
P3500DA	L	5	320	400	800	4	2.2	150	35

L : Lead-free
 ① V_S is measured at 100KV/s
 ②Off-state capacitance is measured in $V_{DC}=2V, V_{RMS}=1V, f=1MHz$

PACKAGE OUTLINE DIMENSIONS in inches (millimeters)

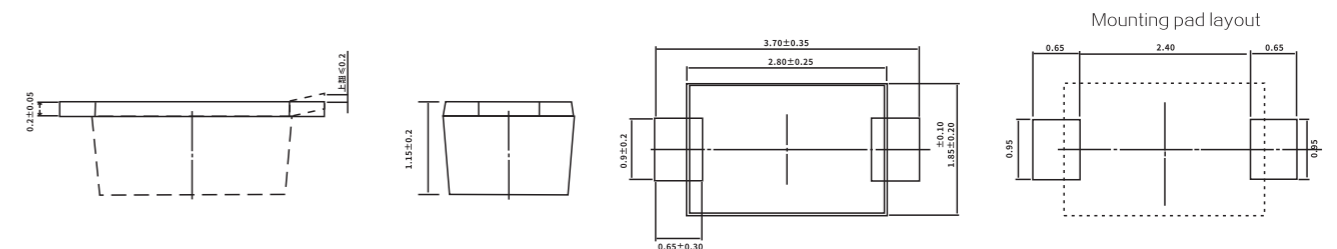

SM/DO-214AC -----TA Series



Surge Ratings

Series	Ipp 2/10µS Amps	Ipp 8/20µS Amps	Ipp 10/160µS Amps	Ipp 10/560µS Amps	Ipp 10/1000µS Amps	ITSM 60HZ Amps	Di/Dt Amps /µS
TA	150	150	90	50	45	20	500

Summary Electrical Characteristics, T a = 25 °C (Unless Otherwise Noted)

Parameter Description		IDRM@VDRM		VS ¹ @IS		Vr@Ir		IH	CO ²
Unit		µA	V	V	mA	V	A	mA	pF
Type	ENV	max	min	max	max	max	max	min	max
P0080TA	L	5	6	25	800	4	2.2	50	80
P0220TA	L	5	15	32	800	4	2.2	50	60
P0300TA	L	5	25	40	800	4	2.2	50	60
P0640TA	L	5	58	77	800	4	2.2	150	50
P0720TA	L	5	65	87	800	4	2.2	150	50
P0900TA	L	5	75	98	800	4	2.2	150	50
P1100TA	L	5	90	130	800	4	2.2	150	45
P1300TA	L	5	120	160	800	4	2.2	150	45
P1500TA	L	5	140	180	800	4	2.2	150	45
P1800TA	L	5	170	220	800	4	2.2	150	35
P2300TA	L	5	190	260	800	4	2.2	150	35
P2600TA	L	5	220	300	800	4	2.2	150	35
P3100TA	L	5	275	350	800	4	2.2	150	35
P3500TA	L	5	320	400	800	4	2.2	150	35

L : Lead-free
 ①Vs is measured at 100KV/s
 ②Off-state capacitance is measured in VDC=2V, VRMS=1V, f=1MHz

PACKAGE OUTLINE DIMENSIONS in inches (millimeters)

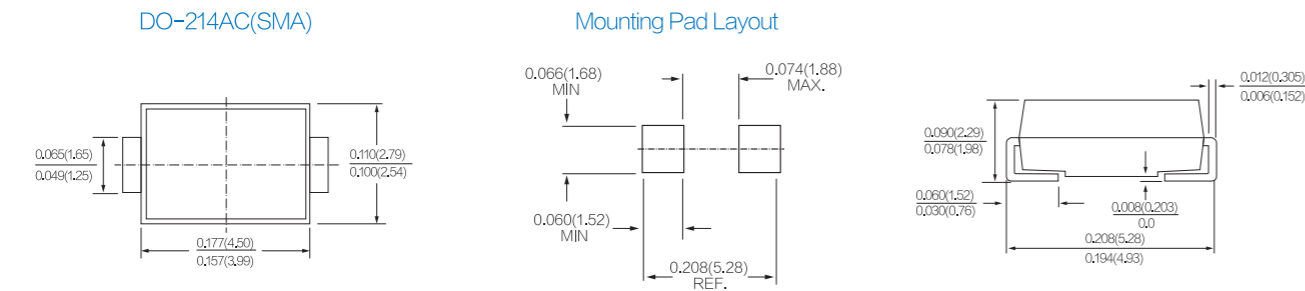

SMB/DO-214AA -----S Series



Surge Ratings

Series	Ipp 2/10µS Amps	Ipp 8/20µS Amps	Ipp 10/160µS Amps	Ipp 10/560µS Amps	Ipp 10/1000µS Amps	ITSM 60HZ Amps	Di/Dt Amps /µS
SA	150	150	90	50	45	20	500
SB	250	250	150	100	80	30	500
SC	500	400	200	150	100	50	500

Summary Electrical Characteristics, T a = 25 °C (Unless Otherwise Noted)

Parameter Description		IDRM@VDRM		VS ¹ @IS		Vr@Ir		IH	CO ²		
Unit		µA	V	V	mA	V	A	mA	A	B	C
Type	ENV	max	min	max	max	max	max	min	max		
P0080S	L	5	6	25	800	4	2.2	50	80	130	130
P0220S	L	5	18	30	800	4	2.2	50	60	120	120
P0300S	L	5	25	40	800	4	2.2	50	60	120	100
P0640S	L	5	58	77	800	4	2.2	150	50	80	200
P0720S	L	5	66	87	800	4	2.2	150	50	75	150
P0900S	L	5	75	98	800	4	2.2	150	50	70	140
P1100S	L	5	90	130	800	4	2.2	150	45	70	110
P1300S	L	5	120	160	800	4	2.2	150	45	60	100
P1500S	L	5	140	180	800	4	2.2	150	45	55	90
P1800S	L	5	170	220	800	4	2.2	150	35	50	90
P2300S	L	5	190	260	800	4	2.2	150	35	50	80
P2600S	L	5	220	300	800	4	2.2	150	35	45	80
P3100S	L	5	275	350	800	4	2.2	150	35	45	75
P3500S	L	5	320	400	800	4	2.2	150	35	40	60

For individual "SA" "SB" "SC" Surge ratings, see table above
 L : Lead-free
 ①Vs is measured at 100KV/s
 ②Off-state capacitance is measured in VDC=2V, VRMS=1V, f=1MHz

PACKAGE OUTLINE DIMENSIONS in inches (millimeters)

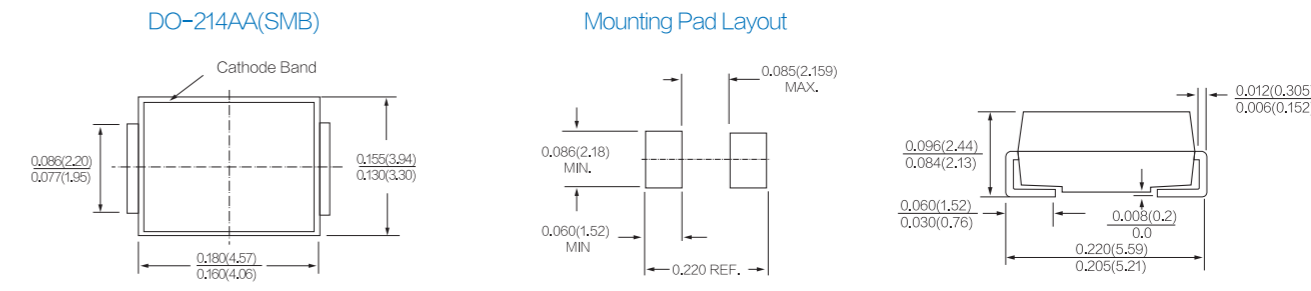

SM/DO-214AC -----TA Series



Surge Ratings

Series	Ipp 2/10µS Amps	Ipp 8/20µS Amps	Ipp 10/160µS Amps	Ipp 10/560µS Amps	Ipp 10/1000µS Amps	ITSM 60HZ Amps	Di/Dt Amps /µS
TA	150	150	90	50	45	20	500

Summary Electrical Characteristics, T a = 25 °C (Unless Otherwise Noted)

Parameter Description		IDRM@VDRM		VS ¹ @IS		Vr@Ir		IH	CO ²
Unit		µA	V	V	mA	V	A	mA	pF
Type	ENV	max	min	max	max	max	max	min	max
P0080TA	L	5	6	25	800	4	2.2	50	80
P0220TA	L	5	15	32	800	4	2.2	50	60
P0300TA	L	5	25	40	800	4	2.2	50	60
P0640TA	L	5	58	77	800	4	2.2	150	50
P0720TA	L	5	65	87	800	4	2.2	150	50
P0900TA	L	5	75	98	800	4	2.2	150	50
P1100TA	L	5	90	130	800	4	2.2	150	45
P1300TA	L	5	120	160	800	4	2.2	150	45
P1500TA	L	5	140	180	800	4	2.2	150	45
P1800TA	L	5	170	220	800	4	2.2	150	35
P2300TA	L	5	190	260	800	4	2.2	150	35
P2600TA	L	5	220	300	800	4	2.2	150	35
P3100TA	L	5	275	350	800	4	2.2	150	35
P3500TA	L	5	320	400	800	4	2.2	150	35

L : Lead-free
 ①Vs is measured at 100KV/s
 ②Off-state capacitance is measured in VDC=2V, VRMS=1V, f=1MHz

PACKAGE OUTLINE DIMENSIONS in inches (millimeters)

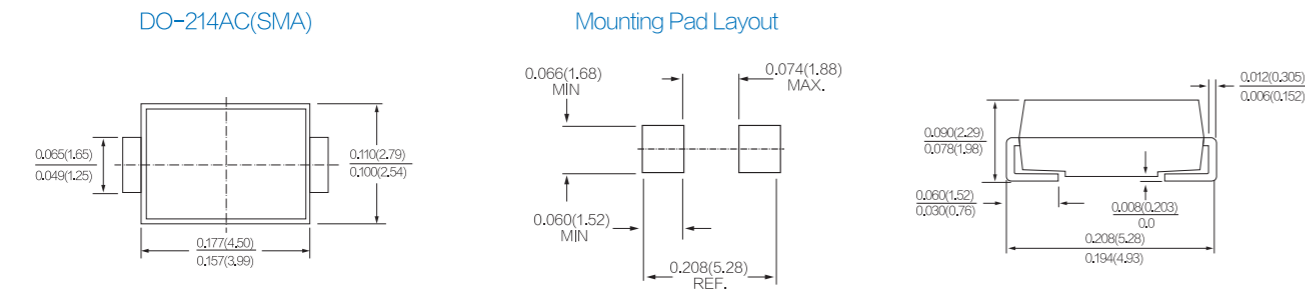

SMB/DO-214AA -----S Series



Surge Ratings

Series	Ipp 2/10µS Amps	Ipp 8/20µS Amps	Ipp 10/160µS Amps	Ipp 10/560µS Amps	Ipp 10/1000µS Amps	ITSM 60HZ Amps	Di/Dt Amps /µS
SA	150	150	90	50	45	20	500
SB	250	250	150	100	80	30	500
SC	500	400	200	150	100	50	500

Summary Electrical Characteristics, T a = 25 °C (Unless Otherwise Noted)

Parameter Description		IDRM@VDRM		VS ¹ @IS		Vr@Ir		IH	CO ²		
Unit		µA	V	V	mA	V	A	mA	A	B	C
Type	ENV	max	min	max	max	max	max	min	max		
P0080S	L	5	6	25	800	4	2.2	50	80	130	130
P0220S	L	5	18	30	800	4	2.2	50	60	120	120
P0300S	L	5	25	40	800	4	2.2	50	60	120	100
P0640S	L	5	58	77	800	4	2.2	150	50	80	200
P0720S	L	5	66	87	800	4	2.2	150	50	75	150
P0900S	L	5	75	98	800	4	2.2	150	50	70	140
P1100S	L	5	90	130	800	4	2.2	150	45	70	110
P1300S	L	5	120	160	800	4	2.2	150	45	60	100
P1500S	L	5	140	180	800	4	2.2	150	45	55	90
P1800S	L	5	170	220	800	4	2.2	150	35	50	90
P2300S	L	5	190	260	800	4	2.2	150	35	50	80
P2600S	L	5	220	300	800	4	2.2	150	35	45	80
P3100S	L	5	275	350	800	4	2.2	150	35	45	75
P3500S	L	5	320	400	800	4	2.2	150	35	40	60

For individual "SA" "SB" "SC" Surge ratings, see table above
 L : Lead-free
 ①Vs is measured at 100KV/s
 ②Off-state capacitance is measured in VDC=2V, VRMS=1V, f=1MHz

PACKAGE OUTLINE DIMENSIONS in inches (millimeters)

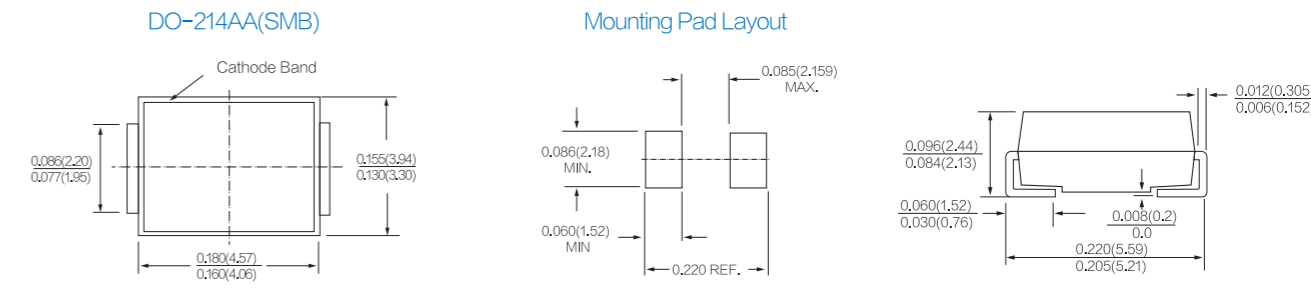

TSS

DO-15/DO-27 -----L Series



Surge Ratings

Series	Ipp 2/10μS Amps	Ipp 8/20μS Amps	Ipp 10/160μS Amps	Ipp 10/560μS Amps	Ipp 10/1000μS Amps	ITSM 60HZ Amps	Di/Dt Amps /μS
LA	150	150	90	50	45	20	500
LB	250	250	150	100	80	30	500
LC	500	400	200	150	100	50	500

Summary Electrical Characteristics, T a = 25 °C (Unless Otherwise Noted)

Parameter Description		IDRM@VDRM		VS ¹ @IS		VT@IT		IH	CO ²		
Unit		μA	V	V	mA	V	A	mA	A	B	C
Type	ENV	max	min	max	max	max	max	min	max		
P0080L	L	5	6	25	800	4	2.2	50	80	130	130
P0220L	L	5	18	30	800	4	2.2	50	60	120	120
P0300L	L	5	25	40	800	4	2.2	50	60	120	100
P0640L	L	5	58	77	800	4	2.2	150	50	80	200
P0720L	L	5	66	87	800	4	2.2	150	50	75	150
P0900L	L	5	75	98	800	4	2.2	150	50	70	140
P1100L	L	5	90	130	800	4	2.2	150	45	70	110
P1300L	L	5	120	160	800	4	2.2	150	45	60	100
P1500L	L	5	140	180	800	4	2.2	150	45	55	90
P1800L	L	5	170	220	800	4	2.2	150	35	50	90
P2300L	L	5	190	260	800	4	2.2	150	35	50	80
P2600L	L	5	220	300	800	4	2.2	150	35	45	80
P3100L	L	5	275	350	800	4	2.2	150	35	45	75
P3500L	L	5	320	400	800	4	2.2	150	35	40	60

For individual "LA" "LB" "LC" Surge ratings, see table above
 L : Lead-free
 ①Vs is measured at 100KV/s
 ②Off-state capacitance is measured in VDC=2V, VRMS=1V, f=1MHz

PACKAGE OUTLINE DIMENSIONS in inches (millimeters)

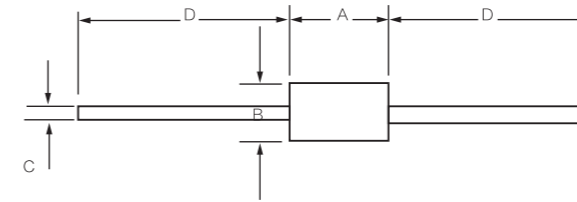

DO-15

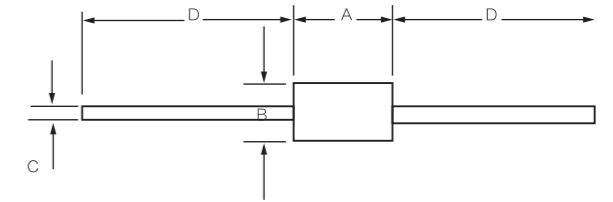

DO-27

DO-15 LA&LB Series

DIM	Inches		Millimeters	
	Min	Max	Min	Max
A	0.230	0.300	5.80	7.60
B	0.104	0.140	2.60	3.60
C	0.026	0.034	0.70	0.90
D	1.000	-	25.40	-

DO-27 LC Series

DIM	Inches		Millimeters	
	Min	Max	Min	Max
A	-	0.370	-	9.50
B	-	0.250	-	6.40
C	0.048	0.052	1.20	1.30
D	1.000	-	25.40	-

DO-15/DO-27 -----L Series



Surge Ratings

Series	Ipp 2/10µS Amps	Ipp 8/20µS Amps	Ipp 10/160µS Amps	Ipp 10/560µS Amps	Ipp 10/1000µS Amps	ITSM 60HZ Amps	Di/Dt Amps /µS
LA	150	150	90	50	45	20	500
LB	250	250	150	100	80	30	500
LC	500	400	200	150	100	50	500

Summary Electrical Characteristics, T a = 25 °C (Unless Otherwise Noted)

Parameter Description		IDRM@VDRM		VS ¹ @IS		VT@IT		IH	CO ²		
Unit		µA	V	V	mA	V	A	mA	A	B	C
Type	ENV	max	min	max	max	max	max	min	max		
P0080L	L	5	6	25	800	4	2.2	50	80	130	130
P0220L	L	5	18	30	800	4	2.2	50	60	120	120
P0300L	L	5	25	40	800	4	2.2	50	60	120	100
P0640L	L	5	58	77	800	4	2.2	150	50	80	200
P0720L	L	5	66	87	800	4	2.2	150	50	75	150
P0900L	L	5	75	98	800	4	2.2	150	50	70	140
P1100L	L	5	90	130	800	4	2.2	150	45	70	110
P1300L	L	5	120	160	800	4	2.2	150	45	60	100
P1500L	L	5	140	180	800	4	2.2	150	45	55	90
P1800L	L	5	170	220	800	4	2.2	150	35	50	90
P2300L	L	5	190	260	800	4	2.2	150	35	50	80
P2600L	L	5	220	300	800	4	2.2	150	35	45	80
P3100L	L	5	275	350	800	4	2.2	150	35	45	75
P3500L	L	5	320	400	800	4	2.2	150	35	40	60

For individual "LA" "LB" "LC" Surge ratings, see table above
 L : Lead-free
 ①Vs is measured at 100KV/s
 ②Off-state capacitance is measured in VDC=2V, VRMS=1V, f=1MHz

PACKAGE OUTLINE DIMENSIONS in inches (millimeters)

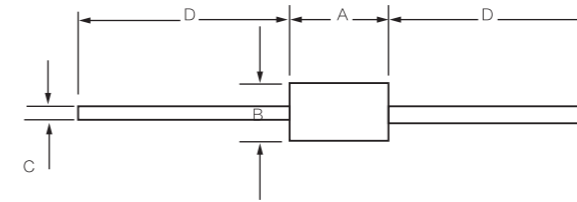

DO-15

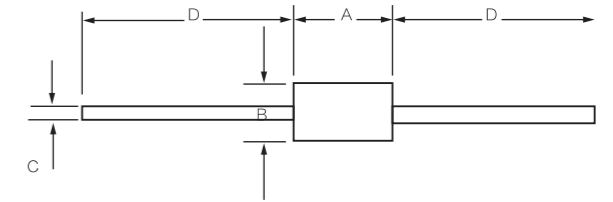

DO-27

DO-15 LA&LB Series

DIM	Inches		Millimeters	
	Min	Max	Min	Max
A	0.230	0.300	5.80	7.60
B	0.104	0.140	2.60	3.60
C	0.026	0.034	0.70	0.90
D	1.000	-	25.40	-

DO-27 LC Series

DIM	Inches		Millimeters	
	Min	Max	Min	Max
A	-	0.370	-	9.50
B	-	0.250	-	6.40
C	0.048	0.052	1.20	1.30
D	1.000	-	25.40	-

气体放电管 GDT (Gas Discharge Tubes)

气体放电管通过气体电离放电的原理来消除浪涌电压，他们具有高绝缘阻抗，低电容，和低漏电流的特点，因此对设备的正常运行影响很小。

YINT可提供高性能的小封装的插件/贴片的气体放电管，具有很快的响应速度，大浪涌抑制能力，从而降低设备损坏的风险。因为GDT的浪涌吸收能力，是雷击浪涌防护的一个很好的选择，特别适用于室外的电信设备。

Gas discharge tubes eliminate the surge voltage by the principle of gas ionization discharge. They have high insulation resistance, low capacitance and low leakage current to ensure minimal effect on normal operation of equipment.

YINT provides high-performance and small size packaging (DIP/SMD) gas discharge tubes with fast response speed and surge suppression capability, which reduces the risk of equipment damage, this is also a good choice for protecting devices from damaging by surge current caused by lightning, especially suitable for outdoor telecommunications equipment.



特点 Feature

- ▲ 高绝缘电阻 High insulation resistance
- ▲ 开关型过压保护器件 Crowbar overvoltage protection
- ▲ 低电容和插入损耗 Low capacitance and insertion loss
- ▲ 电压从70V到3000V Voltage from 70V to 3000V
- ▲ 冲击电流可以高达数百千安 Surge current up to several hundred thousand Amps

Application

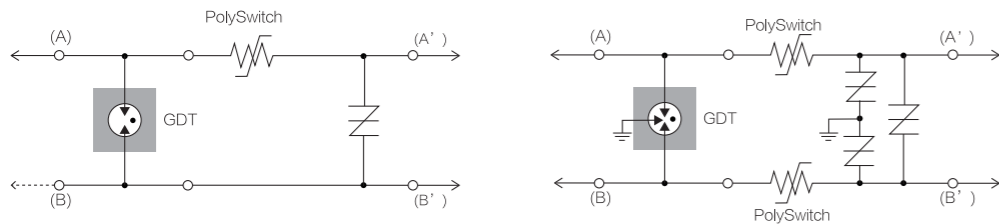

Limitation of a sinusoidal overvoltage by a surge arrester

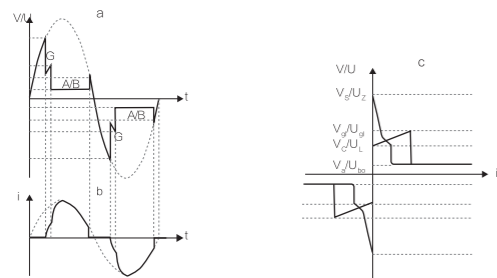

- a: shows the voltage curve at the arrester
- b: the current as a function of time when limiting a sinusoidal voltage surge.
- c: The V/I characteristic of the surge arrester was obtained by combining the graphs of voltage and current as a function of time.

SMD1206 Series Electrical Characteristics

Part Number	DC Spark-over Voltage	Impulse Spark-over Voltage	Minimum Insulation Resistance		Maximum Capacitance	Nominal Impulse Discharge Current	Impulse Discharge Voltage
	100V/s (V)		1KV/ μ s (V)	Test Voltage(V)			
SMD1206-091	90 \pm 30%	<750	50	1000	0.3	0.5KA	4KV
SMD1206-151	150 \pm 30%	<750	50	1000	0.3	0.5KA	4KV
SMD1206-201	200 \pm 30%	<950	100	1000	0.3	0.5KA	4KV
SMD1206-231	230 \pm 30%	<950	100	1000	0.3	0.5KA	4KV
SMD1206-301	300 \pm 30%	<950	100	1000	0.3	0.5KA	4KV
SMD1206-351	350 \pm 30%	<950	100	1000	0.3	0.5KA	4KV
SMD1206-401	400 \pm 30%	<1050	100	1000	0.3	0.5KA	4KV
SMD1206-421	420 \pm 30%	<1050	100	1000	0.3	0.5KA	4KV
SMD1206-471	470 \pm 30%	<1050	100	1000	0.3	0.5KA	4KV

PACKAGE OUTLINE DIMENSIONS in millimeters :SMD1206

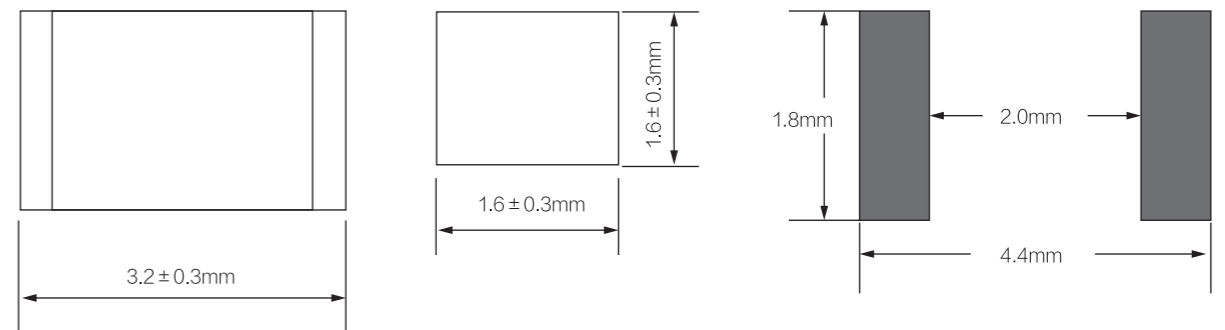

Mounting Pad Layout

气体放电管 GDT (Gas Discharge Tubes)

气体放电管通过气体电离放电的原理来消除浪涌电压，他们具有高绝缘阻抗，低电容，和低漏电流的特点，因此对设备的正常运行影响很小。

YINT可提供高性能的小封装的插件/贴片的气体放电管，具有很快的响应速度，大浪涌抑制能力，从而降低设备损坏的风险。因为GDT的浪涌吸收能力，是雷击浪涌防护的一个很好的选择，特别适用于室外的电信设备。

Gas discharge tubes eliminate the surge voltage by the principle of gas ionization discharge. They have high insulation resistance, low capacitance and low leakage current to ensure minimal effect on normal operation of equipment.

YINT provides high-performance and small size packaging (DIP/SMD) gas discharge tubes with fast response speed and surge suppression capability, which reduces the risk of equipment damage, this is also a good choice for protecting devices from damaging by surge current caused by lightning, especially suitable for outdoor telecommunications equipment.



特点 Feature

- ▲ 高绝缘电阻 High insulation resistance
- ▲ 开关型过压保护器件 Crowbar overvoltage protection
- ▲ 低电容和插入损耗 Low capacitance and insertion loss
- ▲ 电压从70V到3000V Voltage from 70V to 3000V
- ▲ 冲击电流可以高达数百千安 Surge current up to several hundred thousand Amps

Application

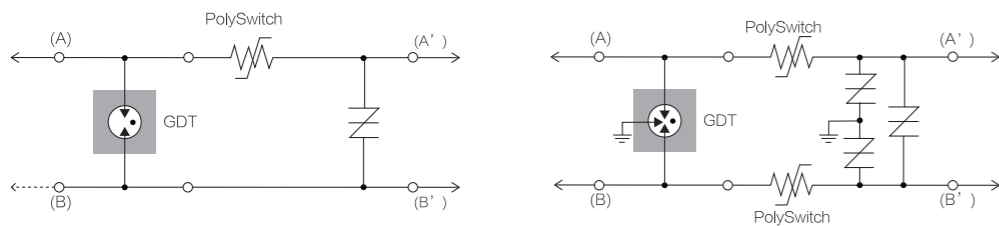

Limitation of a sinusoidal overvoltage by a surge arrester

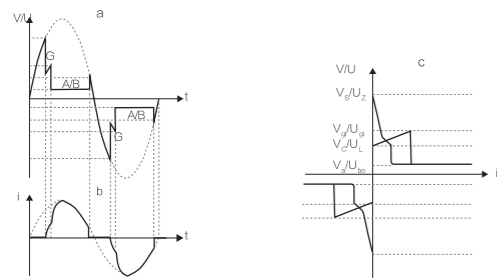

- a: shows the voltage curve at the arrester
- b: the current as a function of time when limiting a sinusoidal voltage surge.
- c: The V/I characteristic of the surge arrester was obtained by combining the graphs of voltage and current as a function of time.

SMD1206 Series Electrical Characteristics

Part Number	DC Spark-over Voltage	Impulse Spark-over Voltage	Minimum Insulation Resistance		Maximum Capacitance	Nominal Impulse Discharge Current	Impulse Discharge Voltage
	100V/s (V)	1KV/ μ s (V)	Test Voltage(V)	(M Ω)	1MHz (pF)	8/20 μ s	10/700 μ S
SMD1206-091	90 \pm 30%	<750	50	1000	0.3	0.5KA	4KV
SMD1206-151	150 \pm 30%	<750	50	1000	0.3	0.5KA	4KV
SMD1206-201	200 \pm 30%	<950	100	1000	0.3	0.5KA	4KV
SMD1206-231	230 \pm 30%	<950	100	1000	0.3	0.5KA	4KV
SMD1206-301	300 \pm 30%	<950	100	1000	0.3	0.5KA	4KV
SMD1206-351	350 \pm 30%	<950	100	1000	0.3	0.5KA	4KV
SMD1206-401	400 \pm 30%	<1050	100	1000	0.3	0.5KA	4KV
SMD1206-421	420 \pm 30%	<1050	100	1000	0.3	0.5KA	4KV
SMD1206-471	470 \pm 30%	<1050	100	1000	0.3	0.5KA	4KV

PACKAGE OUTLINE DIMENSIONS in millimeters :SMD1206

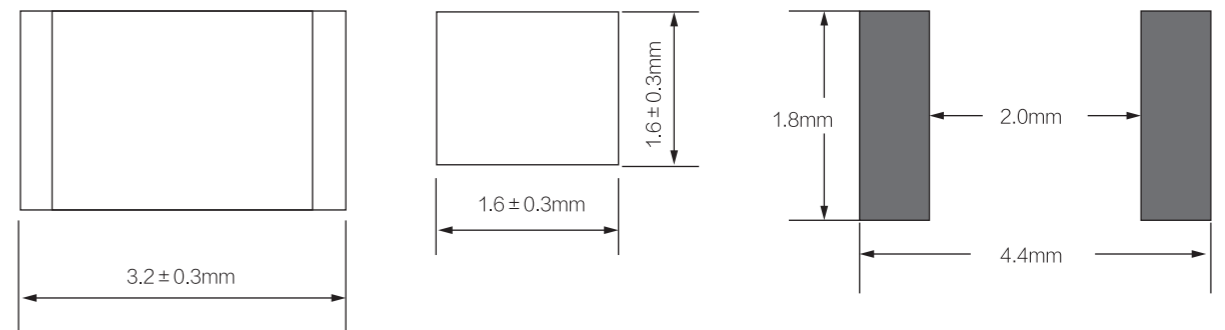

Mounting Pad Layout

SMD1812 Series Electrical Characteristics



Part Number	DC Spark-over Voltage	Impulse Spark-over Voltage	Minimum Insulation Resistance		Maximum Capacitance	Nominal Impulse Discharge Current	Impulse Discharge Voltage
	100V/s (V)		Test Voltage(V)	(MΩ)			
SMD1812-071	75±30%	300	50	1	0.5	2KA	4KV
SMD1812-091	90±30%	300	50	1	0.5	2KA	4KV
SMD1812-121	120±30%	300	50	1	0.5	2KA	4KV
SMD1812-151	150±30%	300	50	1	0.5	2KA	4KV
SMD1812-201	200±30%	300	100	1	0.5	2KA	4KV
SMD1812-231	230±30%	300	100	1	0.5	2KA	4KV
SMD1812-301	300±30%	300	100	1	0.5	2KA	4KV
SMD1812-351	350±30%	300	100	1	0.5	2KA	4KV
SMD1812-401	400±30%	300	100	1	0.5	2KA	4KV
SMD1812-421	420±30%	300	100	1	0.5	2KA	4KV
SMD1812-471	470±30%	300	100	1	0.5	2KA	4KV
SMD1812-501	500±30%	300	100	1	0.5	2KA	4KV
SMD1812-601	600±30%	300	100	1	0.5	2KA	4KV

PACKAGE OUTLINE DIMENSIONS in millimeters :SMD1812

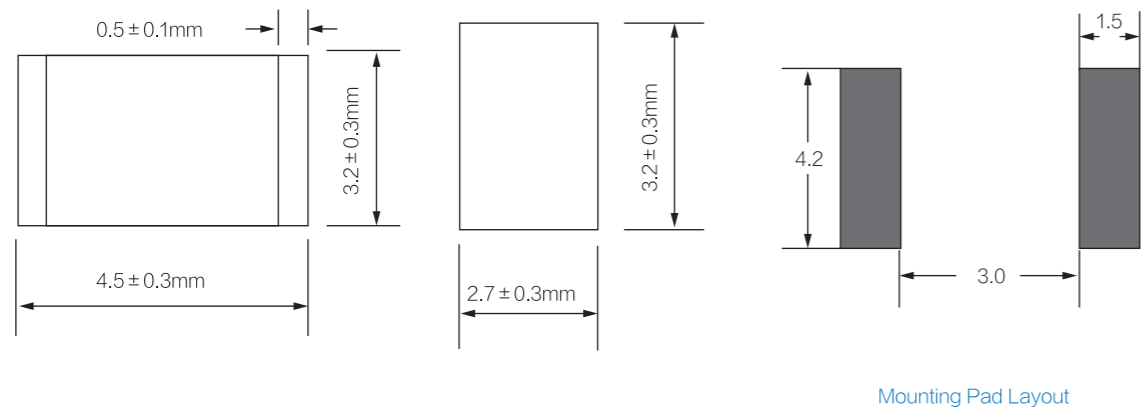

2R***S- 6×4.2 Series Electrical Characteristics (TA = 25 ° C unless otherwise noted)



Part Number	DC Breakdown Voltage	Tolerance	Impulse Spark-over Voltage	Impulse Discharge Current 10hits (5hits each polarity)	AC Discharge Current 5 hits	Insulation Resistance*	Capacitance
	100V/s (V)						
2R075S- 6×4.2	75V	±20%	≤600V	5KA	5A	≥10	≤1pF
2R090S- 6×4.2	90V	±20%	≤600V	5KA	5A	≥10	≤1pF
2R150S- 6×4.2	150V	±20%	≤600V	5KA	5A	≥10	≤1pF
2R200S- 6×4.2	200V	±20%	≤700V	5KA	5A	≥10	≤1pF
2R230S- 6×4.2	230V	±20%	≤700V	5KA	5A	≥10	≤1pF
2R300S- 6×4.2	300V	±20%	≤900V	5KA	5A	≥10	≤1pF
2R350S- 6×4.2	350V	±20%	≤1000V	5KA	5A	≥10	≤1pF
2R400S- 6×4.2	400V	±20%	≤1000V	5KA	5A	≥10	≤1pF
2R470S- 6×4.2	470V	±20%	≤1200V	5KA	5A	≥10	≤1pF
2R600S- 6×4.2	600V	±20%	≤1400V	5KA	5A	≥10	≤1pF
2R1000S- 6×4.2	1000V	±20%	≤1800V	3KA	5A	≥1	≤1pF

1) At delivery AQL 0.65 leave II Military Standard 105 E.
2) In ionized mode
3) Test according to ITU-T Rec.k.12

Specification Status: Draft (mm)

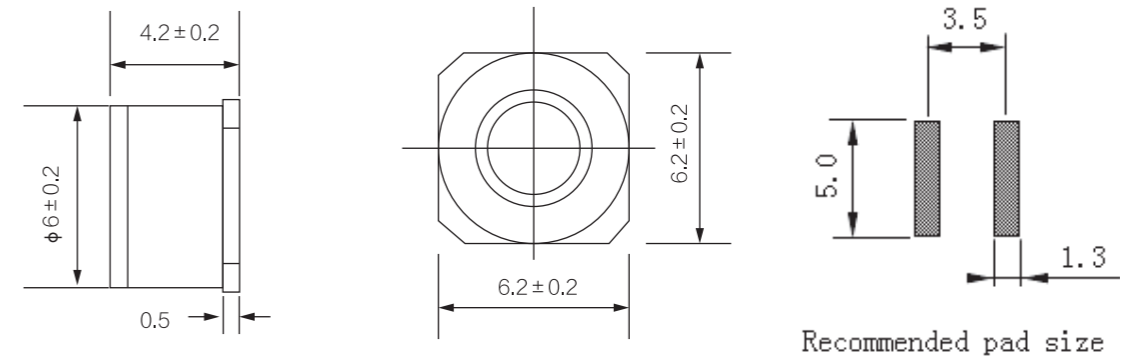

SMD1812 Series Electrical Characteristics



Part Number	DC Spark-over Voltage	Impulse Spark-over Voltage	Minimum Insulation Resistance		Maximum Capacitance	Nominal Impulse Discharge Current	Impulse Discharge Voltage
	100V/s (V)		Test Voltage(V)	(MΩ)			
SMD1812-071	75±30%	300	50	1	0.5	2KA	4KV
SMD1812-091	90±30%	300	50	1	0.5	2KA	4KV
SMD1812-121	120±30%	300	50	1	0.5	2KA	4KV
SMD1812-151	150±30%	300	50	1	0.5	2KA	4KV
SMD1812-201	200±30%	300	100	1	0.5	2KA	4KV
SMD1812-231	230±30%	300	100	1	0.5	2KA	4KV
SMD1812-301	300±30%	300	100	1	0.5	2KA	4KV
SMD1812-351	350±30%	300	100	1	0.5	2KA	4KV
SMD1812-401	400±30%	300	100	1	0.5	2KA	4KV
SMD1812-421	420±30%	300	100	1	0.5	2KA	4KV
SMD1812-471	470±30%	300	100	1	0.5	2KA	4KV
SMD1812-501	500±30%	300	100	1	0.5	2KA	4KV
SMD1812-601	600±30%	300	100	1	0.5	2KA	4KV

PACKAGE OUTLINE DIMENSIONS in millimeters :SMD1812

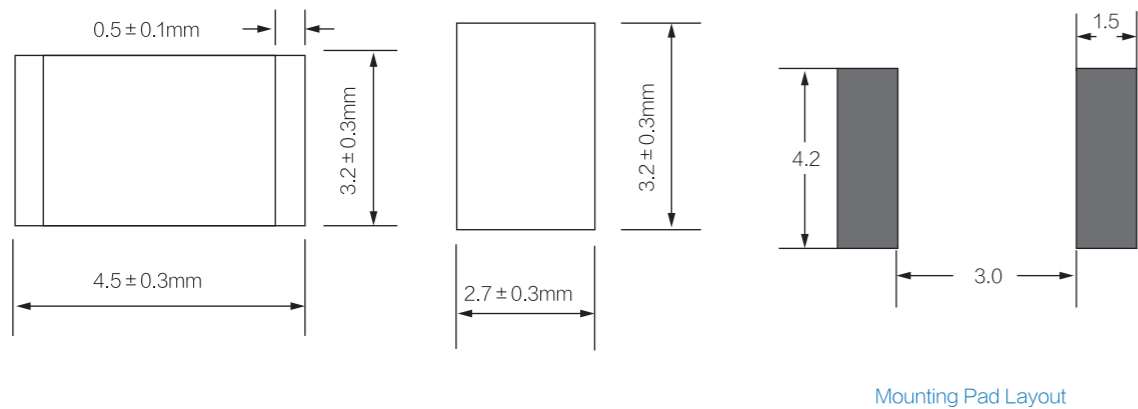

2R***S- 6×4.2 Series Electrical Characteristics (TA = 25 ° C unless otherwise noted)



Part Number	DC Breakdown Voltage	Tolerance	Impulse Spark-over Voltage	Impulse Discharge Current 10hits (5hits each polarity)	AC Discharge Current 5 hits	Insulation Resistance*	Capacitance
	100V/s (V)						
2R075S- 6×4.2	75V	±20%	≤600V	5KA	5A	≥10	≤1pF
2R090S- 6×4.2	90V	±20%	≤600V	5KA	5A	≥10	≤1pF
2R150S- 6×4.2	150V	±20%	≤600V	5KA	5A	≥10	≤1pF
2R200S- 6×4.2	200V	±20%	≤700V	5KA	5A	≥10	≤1pF
2R230S- 6×4.2	230V	±20%	≤700V	5KA	5A	≥10	≤1pF
2R300S- 6×4.2	300V	±20%	≤900V	5KA	5A	≥10	≤1pF
2R350S- 6×4.2	350V	±20%	≤1000V	5KA	5A	≥10	≤1pF
2R400S- 6×4.2	400V	±20%	≤1000V	5KA	5A	≥10	≤1pF
2R470S- 6×4.2	470V	±20%	≤1200V	5KA	5A	≥10	≤1pF
2R600S- 6×4.2	600V	±20%	≤1400V	5KA	5A	≥10	≤1pF
2R1000S- 6×4.2	1000V	±20%	≤1800V	3KA	5A	≥1	≤1pF

1) At delivery AQL 0.65 leave II Military Standard 105 E.
 2) In ionized mode
 3) Test according to ITU-T Rec.k.12

Specification Status: Draft (mm)

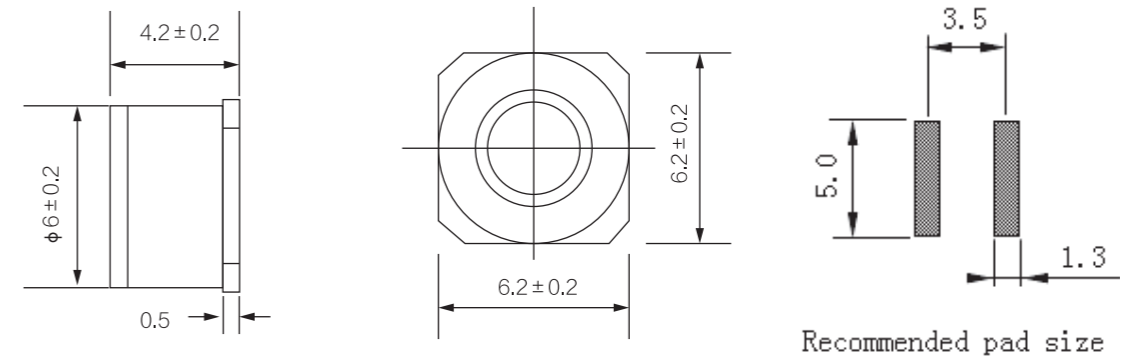

2R***S- 8×6 Series Electrical Characteristics (TA = 25 ° C unless otherwise noted)



Part Number	DC Breakdown Voltage	Tolerance	Impulse Spark-over Voltage	Impulse Discharge Current 10hits (5hits each polarity)	AC Discharge Current 5 hits	Insulation Resistance*	Capacitance
	100V/s (V)	of Vs	1KV/μs (V)	8/20μs	50Hz	GΩ	1MHz
2R075S- 8×6	75V	±20%	≤600V	10KA	10A	≥10	≤1pF
2R090S- 8×6	90V	±20%	≤600V	10KA	10A	≥10	≤1pF
2R150S- 8×6	150V	±20%	≤700V	10KA	10A	≥10	≤1pF
2R200S- 8×6	200V	±20%	≤700V	10KA	10A	≥10	≤1pF
2R230S- 8×6	230V	±20%	≤700V	10KA	10A	≥10	≤1pF
2R300S- 8×6	300V	±20%	≤900V	10KA	10A	≥10	≤1pF
2R350S- 8×6	350V	±20%	≤1000V	10KA	10A	≥10	≤1pF
2R400S- 8×6	400V	±20%	≤1000V	10KA	10A	≥10	≤1pF
2R470S- 8×6	470V	±20%	≤1200V	10KA	10A	≥10	≤1pF
2R600S- 8×6	600V	±20%	≤1400V	10KA	10A	≥10	≤1pF

1) At delivery AQL 0.65 leave II Military Standard 105 E.
 2) In ionized mode
 3) Test according to ITU-T Rec.k.12

Specification Status: Draft (mm)

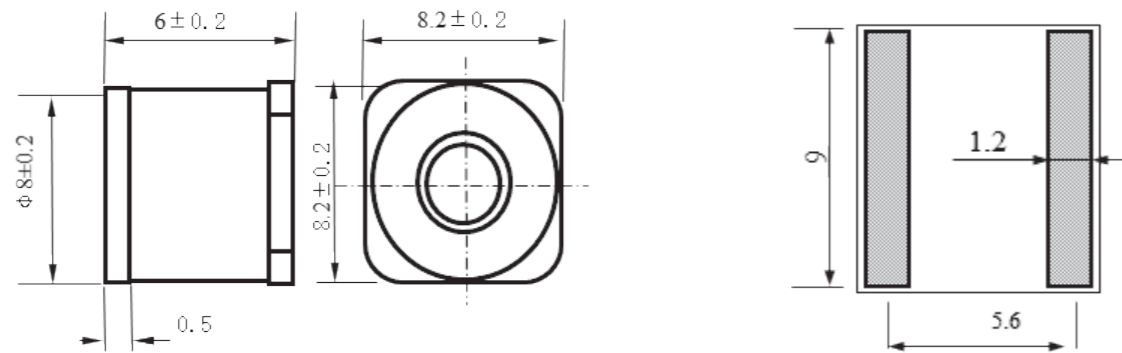

2R***L- 5.5×6 Series Electrical Characteristics (TA = 25 ° C unless otherwise noted)



Part Number	DC Breakdown Voltage	Tolerance	Impulse Spark-over Voltage	Impulse Discharge Current 10hits (5hits each polarity)	AC Discharge Current 5 hits	Insulation Resistance*	Capacitance
	100V/s (V)	of Vs	1KV/μs (V)	8/20μs	50Hz	GΩ	1MHz
2R075L- 5.5×6	75V	±20%	≤600V	5KA	5A	≥10	≤1pF
2R090L- 5.5×6	90V	±20%	≤600V	5KA	5A	≥10	≤1pF
2R150L- 5.5×6	150V	±20%	≤600V	5KA	5A	≥10	≤1pF
2R200L- 5.5×6	200V	±20%	≤700V	5KA	5A	≥10	≤1pF
2R230L- 5.5×6	230V	±20%	≤700V	5KA	5A	≥10	≤1pF
2R300L- 5.5×6	300V	±20%	≤900V	5KA	5A	≥10	≤1pF
2R350L- 5.5×6	350V	±20%	≤1000V	5KA	5A	≥10	≤1pF
2R400L- 5.5×6	400V	±20%	≤1000V	5KA	5A	≥10	≤1pF
2R470L- 5.5×6	470V	±20%	≤1200V	5KA	5A	≥10	≤1pF
2R600L- 5.5×6	600V	±20%	≤1400V	5KA	5A	≥10	≤1pF
2R1000L- 5.5×6	1000V	±20%	≤2000V	3KA	3A	≥1	≤1pF

1) At delivery AQL 0.65 leave II Military Standard 105 E.
 2) In ionized mode
 3) Test according to ITU-T Rec.k.12

Specification Status: Draft (mm)

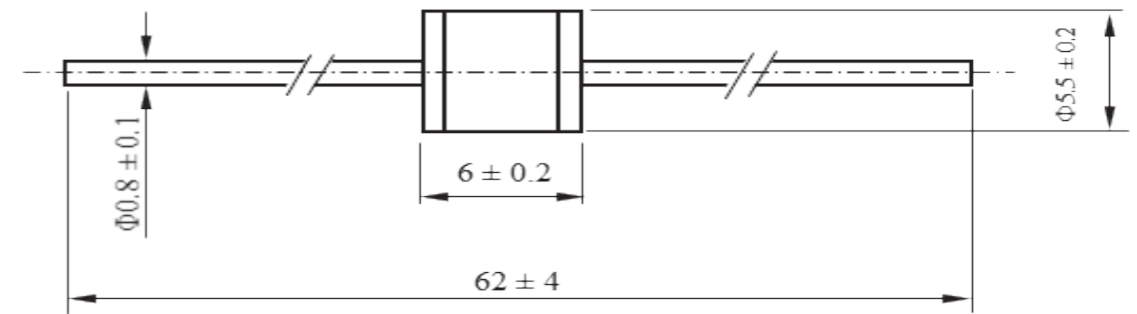

2R***S- 8×6 Series Electrical Characteristics (TA = 25 ° C unless otherwise noted)



Part Number	DC Breakdown Voltage	Tolerance	Impulse Spark-over Voltage	Impulse Discharge Current 10hits (5hits each polarity)	AC Discharge Current 5 hits	Insulation Resistance*	Capacitance
	100V/s (V)	of Vs	1KV/μs (V)	8/20μs	50Hz	GΩ	1MHz
2R075S- 8×6	75V	±20%	≤600V	10KA	10A	≥10	≤1pF
2R090S- 8×6	90V	±20%	≤600V	10KA	10A	≥10	≤1pF
2R150S- 8×6	150V	±20%	≤700V	10KA	10A	≥10	≤1pF
2R200S- 8×6	200V	±20%	≤700V	10KA	10A	≥10	≤1pF
2R230S- 8×6	230V	±20%	≤700V	10KA	10A	≥10	≤1pF
2R300S- 8×6	300V	±20%	≤900V	10KA	10A	≥10	≤1pF
2R350S- 8×6	350V	±20%	≤1000V	10KA	10A	≥10	≤1pF
2R400S- 8×6	400V	±20%	≤1000V	10KA	10A	≥10	≤1pF
2R470S- 8×6	470V	±20%	≤1200V	10KA	10A	≥10	≤1pF
2R600S- 8×6	600V	±20%	≤1400V	10KA	10A	≥10	≤1pF

1) At delivery AQL 0.65 leave II Military Standard 105 E.
 2) In ionized mode
 3) Test according to ITU-T Rec.k.12

Specification Status: Draft (mm)

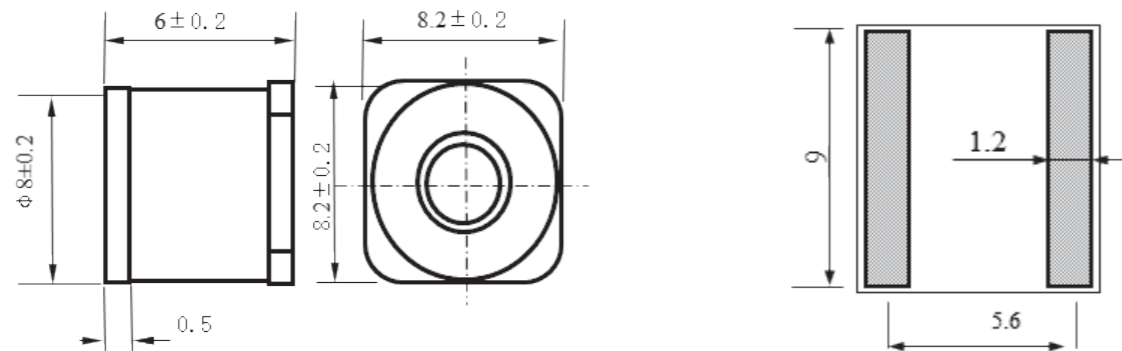

2R***L- 5.5×6 Series Electrical Characteristics (TA = 25 ° C unless otherwise noted)



Part Number	DC Breakdown Voltage	Tolerance	Impulse Spark-over Voltage	Impulse Discharge Current 10hits (5hits each polarity)	AC Discharge Current 5 hits	Insulation Resistance*	Capacitance
	100V/s (V)	of Vs	1KV/μs (V)	8/20μs	50Hz	GΩ	1MHz
2R075L- 5.5×6	75V	±20%	≤600V	5KA	5A	≥10	≤1pF
2R090L- 5.5×6	90V	±20%	≤600V	5KA	5A	≥10	≤1pF
2R150L- 5.5×6	150V	±20%	≤600V	5KA	5A	≥10	≤1pF
2R200L- 5.5×6	200V	±20%	≤700V	5KA	5A	≥10	≤1pF
2R230L- 5.5×6	230V	±20%	≤700V	5KA	5A	≥10	≤1pF
2R300L- 5.5×6	300V	±20%	≤900V	5KA	5A	≥10	≤1pF
2R350L- 5.5×6	350V	±20%	≤1000V	5KA	5A	≥10	≤1pF
2R400L- 5.5×6	400V	±20%	≤1000V	5KA	5A	≥10	≤1pF
2R470L- 5.5×6	470V	±20%	≤1200V	5KA	5A	≥10	≤1pF
2R600L- 5.5×6	600V	±20%	≤1400V	5KA	5A	≥10	≤1pF
2R1000L- 5.5×6	1000V	±20%	≤2000V	3KA	3A	≥1	≤1pF

1) At delivery AQL 0.65 leave II Military Standard 105 E.
 2) In ionized mode
 3) Test according to ITU-T Rec.k.12

Specification Status: Draft (mm)

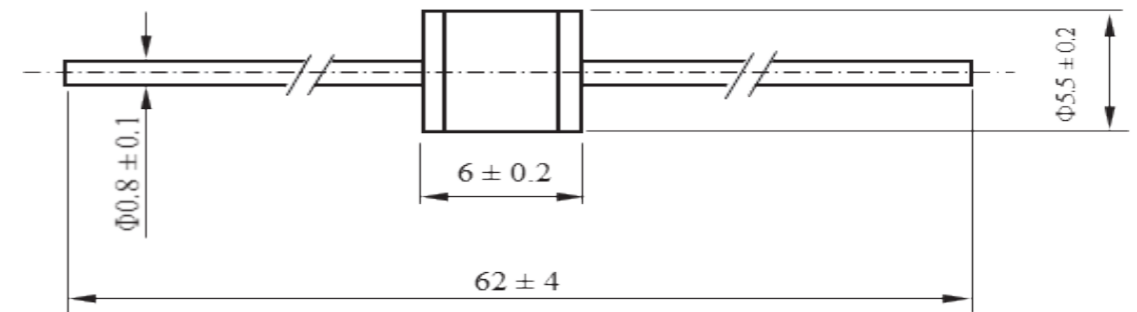

2R***L- 8 × 6 Series Electrical Characteristics (TA = 25 ° C unless otherwise noted)



Part Number	DC Breakdown Voltage	Tolerance	Impulse Spark-over Voltage	Impulse Discharge Current 10hits (5hits each polarity)	AC Discharge Current 5 hits	Insulation Resistance*	Capacitance
	100V/s (V)	of Vs	1KV/μs (V)	8/20μs	50Hz	GΩ	1MHz
2R075L- 8 × 6	75V	±20%	≤600V	10KA	10A	≥10	≤1pF
2R090L- 8 × 6	90V	±20%	≤600V	10KA	10A	≥10	≤1pF
2R150L- 8 × 6	150V	±20%	≤600V	10KA	10A	≥10	≤1pF
2R200L- 8 × 6	200V	±20%	≤700V	10KA	10A	≥10	≤1pF
2R230L- 8 × 6	230V	±20%	≤700V	10KA	10A	≥10	≤1pF
2R300L- 8 × 6	300V	±20%	≤900V	10KA	10A	≥10	≤1pF
2R350L- 8 × 6	350V	±20%	≤1000V	10KA	10A	≥10	≤1pF
2R400L- 8 × 6	400V	±20%	≤1000V	10KA	10A	≥10	≤1pF
2R470L- 8 × 6	470V	±20%	≤1200V	10KA	10A	≥10	≤1pF
2R600L- 8 × 6	600V	±20%	≤1400V	10KA	10A	≥10	≤1pF

1) At delivery AQL 0.65 leave II Military Standard 105 E.
 2) In ionized mode
 3) Test according to ITU-T Rec.k.12

Specification Status: Draft (mm)

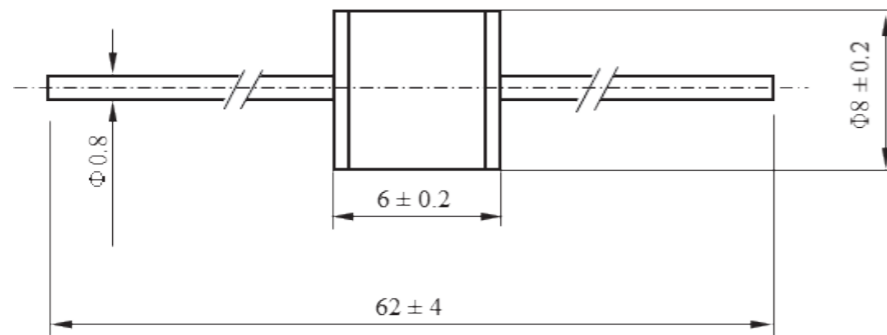

3R***S- 5 × 7.6 Series Electrical Characteristics (TA = 25 ° C unless otherwise noted)



Part Number	DC Breakdown Voltage	Tolerance	Impulse Spark-over Voltage	Impulse Discharge Current 10hits (5hits each polarity)	AC Discharge Current 5 hits	Insulation Resistance*	Capacitance
	100V/s (V)	of Vs	1KV/μs (V)	8/20μs	50Hz	GΩ	1MHz
3R075S- 5 × 7.6	75V	±20%	≤600V	5KA	5A	≥10	≤1pF
3R090S- 5 × 7.6	90V	±20%	≤600V	5KA	5A	≥10	≤1pF
3R150S- 5 × 7.6	150V	±20%	≤600V	5KA	5A	≥10	≤1pF
3R200S- 5 × 7.6	200V	±20%	≤700V	5KA	5A	≥10	≤1pF
3R230S- 5 × 7.6	230V	±20%	≤700V	5KA	5A	≥10	≤1pF
3R300S- 5 × 7.6	300V	±20%	≤900V	5KA	5A	≥10	≤1pF
3R350S- 5 × 7.6	350V	±20%	≤1000V	5KA	5A	≥10	≤1pF
3R400S- 5 × 7.6	400V	±20%	≤1000V	5KA	5A	≥10	≤1pF
3R470S- 5 × 7.6	470V	±20%	≤1200V	5KA	5A	≥10	≤1pF
3R600S- 5 × 7.6	600V	±20%	≤1400V	5KA	5A	≥10	≤1pF

1) At delivery AQL 0.65 leave II Military Standard 105 E.
 2) In ionized mode
 3) Test according to ITU-T Rec.k.12

Specification Status: Draft (mm)

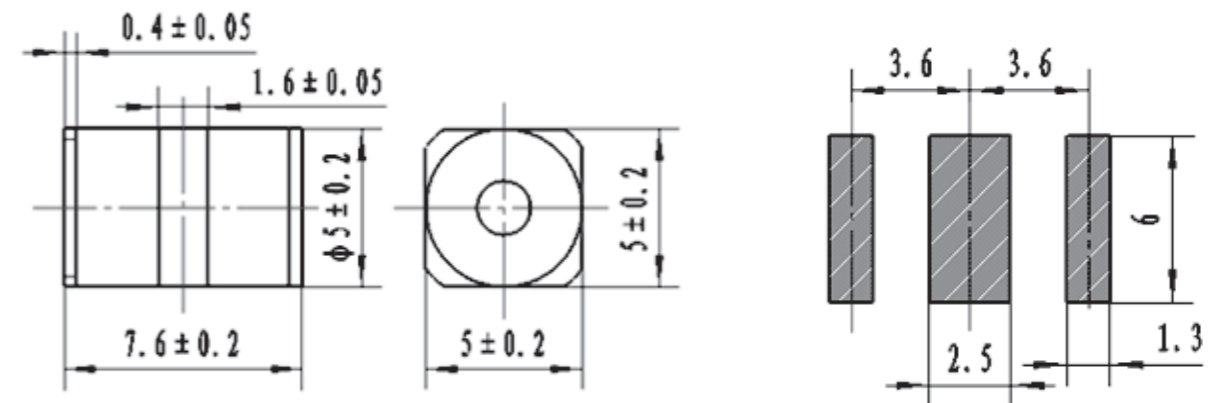

2R***L- 8 × 6 Series Electrical Characteristics (TA = 25 ° C unless otherwise noted)



Part Number	DC Breakdown Voltage	Tolerance	Impulse Spark-over Voltage	Impulse Discharge Current 10hits (5hits each polarity)	AC Discharge Current 5 hits	Insulation Resistance*	Capacitance
	100V/s (V)	of Vs	1KV/μs (V)	8/20μs	50Hz	GΩ	1MHz
2R075L- 8 × 6	75V	±20%	≤600V	10KA	10A	≥10	≤1pF
2R090L- 8 × 6	90V	±20%	≤600V	10KA	10A	≥10	≤1pF
2R150L- 8 × 6	150V	±20%	≤600V	10KA	10A	≥10	≤1pF
2R200L- 8 × 6	200V	±20%	≤700V	10KA	10A	≥10	≤1pF
2R230L- 8 × 6	230V	±20%	≤700V	10KA	10A	≥10	≤1pF
2R300L- 8 × 6	300V	±20%	≤900V	10KA	10A	≥10	≤1pF
2R350L- 8 × 6	350V	±20%	≤1000V	10KA	10A	≥10	≤1pF
2R400L- 8 × 6	400V	±20%	≤1000V	10KA	10A	≥10	≤1pF
2R470L- 8 × 6	470V	±20%	≤1200V	10KA	10A	≥10	≤1pF
2R600L- 8 × 6	600V	±20%	≤1400V	10KA	10A	≥10	≤1pF

- 1) At delivery AQL 0.65 leave II Military Standard 105 E.
- 2) In ionized mode
- 3) Test according to ITU-T Rec.k.12

Specification Status: Draft (mm)

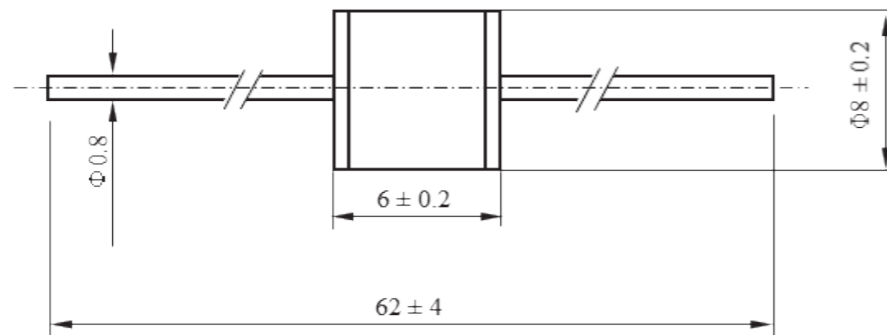

3R***S- 5 × 7.6 Series Electrical Characteristics (TA = 25 ° C unless otherwise noted)



Part Number	DC Breakdown Voltage	Tolerance	Impulse Spark-over Voltage	Impulse Discharge Current 10hits (5hits each polarity)	AC Discharge Current 5 hits	Insulation Resistance*	Capacitance
	100V/s (V)	of Vs	1KV/μs (V)	8/20μs	50Hz	GΩ	1MHz
3R075S- 5 × 7.6	75V	±20%	≤600V	5KA	5A	≥10	≤1pF
3R090S- 5 × 7.6	90V	±20%	≤600V	5KA	5A	≥10	≤1pF
3R150S- 5 × 7.6	150V	±20%	≤600V	5KA	5A	≥10	≤1pF
3R200S- 5 × 7.6	200V	±20%	≤700V	5KA	5A	≥10	≤1pF
3R230S- 5 × 7.6	230V	±20%	≤700V	5KA	5A	≥10	≤1pF
3R300S- 5 × 7.6	300V	±20%	≤900V	5KA	5A	≥10	≤1pF
3R350S- 5 × 7.6	350V	±20%	≤1000V	5KA	5A	≥10	≤1pF
3R400S- 5 × 7.6	400V	±20%	≤1000V	5KA	5A	≥10	≤1pF
3R470S- 5 × 7.6	470V	±20%	≤1200V	5KA	5A	≥10	≤1pF
3R600S- 5 × 7.6	600V	±20%	≤1400V	5KA	5A	≥10	≤1pF

- 1) At delivery AQL 0.65 leave II Military Standard 105 E.
- 2) In ionized mode
- 3) Test according to ITU-T Rec.k.12

Specification Status: Draft (mm)

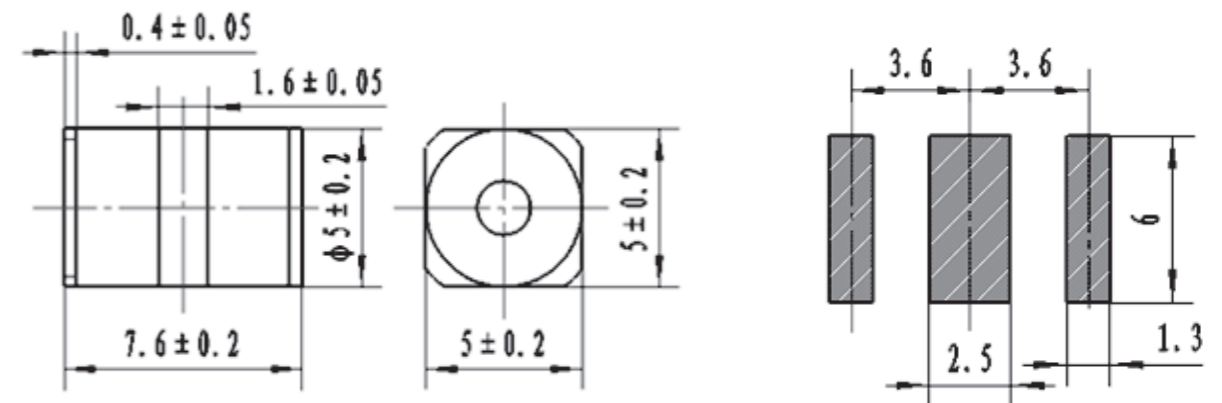

3R***S-6×8 Series Electrical Characteristics (TA = 25 ° C unless otherwise noted)



Part Number	DC Breakdown Voltage	Tolerance	Impulse Spark-over Voltage	Impulse Discharge Current 10hits (5hits each polarity)	AC Discharge Current 5 hits	Insulation Resistance*	Capacitance
	100V/s (V)	of Vs	1KV/μs (V)	8/20μs	50Hz	GΩ	1MHz
3R075S-6×8	75V	±20%	≤600V	10KA	10A	≥10	≤1pF
3R090S-6×8	90V	±20%	≤600V	10KA	10A	≥10	≤1pF
3R150S-6×8	150V	±20%	≤600V	10KA	10A	≥10	≤1pF
3R200S-6×8	200V	±20%	≤700V	10KA	10A	≥10	≤1pF
3R230S-6×8	230V	±20%	≤700V	10KA	10A	≥10	≤1pF
3R300S-6×8	300V	±20%	≤900V	10KA	10A	≥10	≤1pF
3R350S-6×8	350V	±20%	≤1000V	10KA	10A	≥10	≤1pF
3R400S-6×8	400V	±20%	≤1000V	10KA	10A	≥10	≤1pF
3R470S-6×8	470V	±20%	≤1200V	10KA	10A	≥10	≤1pF
3R600S-6×8	600V	±20%	≤1400V	10KA	10A	≥10	≤1pF

1) At delivery AQL 0.65 leave II Military Standard 105 E.
 2) In ionized mode
 3) Test according to ITU-T Rec.k.12

Specification Status: Draft (mm)

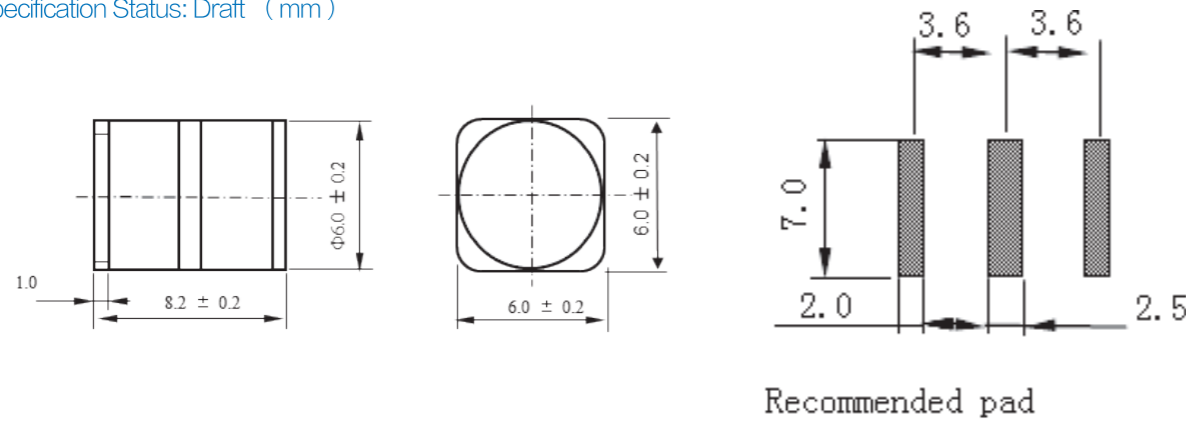

3R***L-5×7.6 Series Electrical Characteristics (TA = 25 ° C unless otherwise noted)



Part Number	DC Breakdown Voltage	Tolerance	Impulse Spark-over Voltage	Impulse Discharge Current 10hits (5hits each polarity)	AC Discharge Current 5 hits	Insulation Resistance*	Capacitance
	100V/s (V)	of Vs	1KV/μs (V)	8/20μs	50Hz	GΩ	1MHz
3R075L-5×7.6	75V	±20%	≤600V	5KA	5A	≥10	≤1pF
3R090L-5×7.6	90V	±20%	≤600V	5KA	5A	≥10	≤1pF
3R150L-5×7.6	150V	±20%	≤600V	5KA	5A	≥10	≤1pF
3R200L-5×7.6	200V	±20%	≤700V	5KA	5A	≥10	≤1pF
3R230L-5×7.6	230V	±20%	≤700V	5KA	5A	≥10	≤1pF
3R300L-5×7.6	300V	±20%	≤900V	5KA	5A	≥10	≤1pF
3R350L-5×7.6	350V	±20%	≤1000V	5KA	5A	≥10	≤1pF
3R400L-5×7.6	400V	±20%	≤1000V	5KA	5A	≥10	≤1pF
3R470L-5×7.6	470V	±20%	≤1200V	5KA	5A	≥10	≤1pF
3R600L-5×7.6	600V	±20%	≤1400V	5KA	5A	≥10	≤1pF

1) At delivery AQL 0.65 leave II Military Standard 105 E.
 2) In ionized mode
 3) Test according to ITU-T Rec.k.12

Specification Status: Draft (mm)

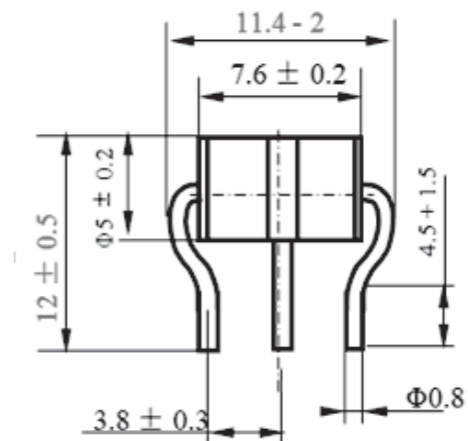

GDT

3R***S-6×8 Series Electrical Characteristics (TA = 25 ° C unless otherwise noted)



Part Number	DC Breakdown Voltage	Tolerance	Impulse Spark-over Voltage	Impulse Discharge Current 10hits (5hits each polarity)	AC Discharge Current 5 hits	Insulation Resistance*	Capacitance
	100V/s (V)	of Vs	1KV/μs (V)	8/20μs	50Hz	GΩ	1MHz
3R075S-6×8	75V	±20%	≤600V	10KA	10A	≥10	≤1pF
3R090S-6×8	90V	±20%	≤600V	10KA	10A	≥10	≤1pF
3R150S-6×8	150V	±20%	≤600V	10KA	10A	≥10	≤1pF
3R200S-6×8	200V	±20%	≤700V	10KA	10A	≥10	≤1pF
3R230S-6×8	230V	±20%	≤700V	10KA	10A	≥10	≤1pF
3R300S-6×8	300V	±20%	≤900V	10KA	10A	≥10	≤1pF
3R350S-6×8	350V	±20%	≤1000V	10KA	10A	≥10	≤1pF
3R400S-6×8	400V	±20%	≤1000V	10KA	10A	≥10	≤1pF
3R470S-6×8	470V	±20%	≤1200V	10KA	10A	≥10	≤1pF
3R600S-6×8	600V	±20%	≤1400V	10KA	10A	≥10	≤1pF

1) At delivery AQL 0.65 leave II Military Standard 105 E.
 2) In ionized mode
 3) Test according to ITU-T Rec.k.12

Specification Status: Draft (mm)

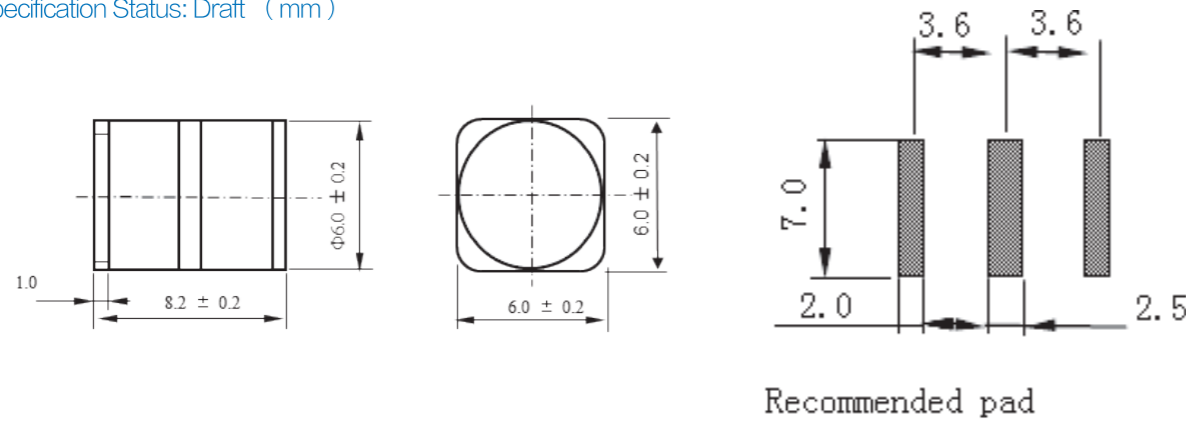

3R***L-5×7.6 Series Electrical Characteristics (TA = 25 ° C unless otherwise noted)



Part Number	DC Breakdown Voltage	Tolerance	Impulse Spark-over Voltage	Impulse Discharge Current 10hits (5hits each polarity)	AC Discharge Current 5 hits	Insulation Resistance*	Capacitance
	100V/s (V)	of Vs	1KV/μs (V)	8/20μs	50Hz	GΩ	1MHz
3R075L-5×7.6	75V	±20%	≤600V	5KA	5A	≥10	≤1pF
3R090L-5×7.6	90V	±20%	≤600V	5KA	5A	≥10	≤1pF
3R150L-5×7.6	150V	±20%	≤600V	5KA	5A	≥10	≤1pF
3R200L-5×7.6	200V	±20%	≤700V	5KA	5A	≥10	≤1pF
3R230L-5×7.6	230V	±20%	≤700V	5KA	5A	≥10	≤1pF
3R300L-5×7.6	300V	±20%	≤900V	5KA	5A	≥10	≤1pF
3R350L-5×7.6	350V	±20%	≤1000V	5KA	5A	≥10	≤1pF
3R400L-5×7.6	400V	±20%	≤1000V	5KA	5A	≥10	≤1pF
3R470L-5×7.6	470V	±20%	≤1200V	5KA	5A	≥10	≤1pF
3R600L-5×7.6	600V	±20%	≤1400V	5KA	5A	≥10	≤1pF

1) At delivery AQL 0.65 leave II Military Standard 105 E.
 2) In ionized mode
 3) Test according to ITU-T Rec.k.12

Specification Status: Draft (mm)

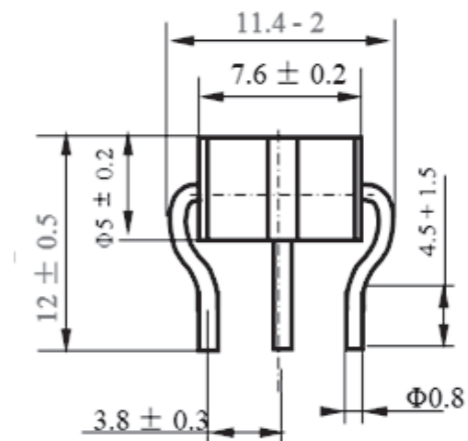

GDT

3R***L- 6 × 8 Series Electrical Characteristics (TA = 25 ° C unless otherwise noted)



Part Number	DC Breakdown Voltage	Tolerance	Impulse Spark-over Voltage	Impulse Discharge Current 10hits (5hits each polarity)	AC Discharge Current 5 hits	Insulation Resistance*	Capacitance
	100V/s (V)	of Vs	1KV/μs (V)	8/20μs	50Hz	GΩ	1MHz
3R075L- 6 × 8	75V	±20%	≤600V	10KA	10A	≥10	≤1pF
3R090L- 6 × 8	90V	±20%	≤600V	10KA	10A	≥10	≤1pF
3R150L- 6 × 8	150V	±20%	≤600V	10KA	10A	≥10	≤1pF
3R200L- 6 × 8	200V	±20%	≤700V	10KA	10A	≥10	≤1pF
3R230L- 6 × 8	230V	±20%	≤700V	10KA	10A	≥10	≤1pF
3R300L- 6 × 8	300V	±20%	≤900V	10KA	10A	≥10	≤1pF
3R350L- 6 × 8	350V	±20%	≤1000V	10KA	10A	≥10	≤1pF
3R400L- 6 × 8	400V	±20%	≤1000V	10KA	10A	≥10	≤1pF
3R470L- 6 × 8	470V	±20%	≤1200V	10KA	10A	≥10	≤1pF
3R600L- 6 × 8	600V	±20%	≤1400V	10KA	10A	≥10	≤1pF

- 1) At delivery AQL 0.65 leave II Military Standard 105 E.
- 2) In ionized mode
- 3) Test according to ITU-T Rec.k.12

Specification Status: Draft (mm)

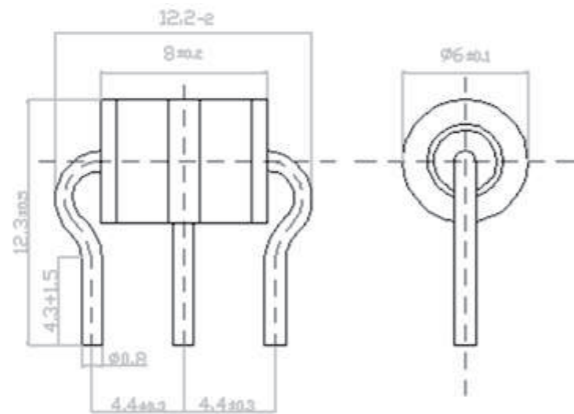

3R***L- 8 × 10 Series Electrical Characteristics (TA = 25 ° C unless otherwise noted)



Part Number	DC Breakdown Voltage	Tolerance	Impulse Spark-over Voltage	Impulse Discharge Current 10hits (5hits each polarity)	AC Discharge Current 5 hits	Insulation Resistance*	Capacitance
	100V/s (V)	of Vs	1KV/μs (V)	8/20μs	50Hz	GΩ	1MHz
3R075L- 8 × 10	75V	±20%	≤600V	10KA	10A	≥10	≤1pF
3R090L- 8 × 10	90V	±20%	≤600V	10KA	10A	≥10	≤1pF
3R150L- 8 × 10	150V	±20%	≤600V	10KA	10A	≥10	≤1pF
3R200L- 8 × 10	200V	±20%	≤700V	10KA	10A	≥10	≤1pF
3R230L- 8 × 10	230V	±20%	≤700V	10KA	10A	≥10	≤1pF
3R300L- 8 × 10	300V	±20%	≤900V	10KA	10A	≥10	≤1pF
3R350L- 8 × 10	350V	±20%	≤1000V	10KA	10A	≥10	≤1pF
3R400L- 8 × 10	400V	±20%	≤1000V	10KA	10A	≥10	≤1pF
3R470L- 8 × 10	470V	±20%	≤1200V	10KA	10A	≥10	≤1pF
3R600L- 8 × 10	600V	±20%	≤1400V	10KA	10A	≥10	≤1pF

- 1) At delivery AQL 0.65 leave II Military Standard 105 E.
- 2) In ionized mode
- 3) Test according to ITU-T Rec.k.12

Specification Status: Draft (mm)

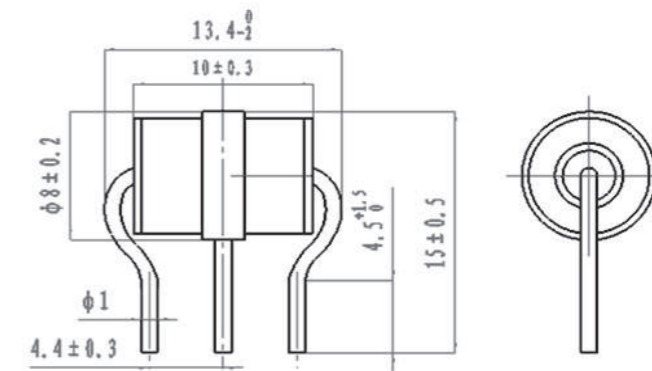

3R***L- 6 × 8 Series Electrical Characteristics (TA = 25 ° C unless otherwise noted)



Part Number	DC Breakdown Voltage	Tolerance	Impulse Spark-over Voltage	Impulse Discharge Current 10hits (5hits each polarity)	AC Discharge Current 5 hits	Insulation Resistance*	Capacitance
	100V/s (V)	of Vs	1KV/μs (V)	8/20μs	50Hz	GΩ	1MHz
3R075L- 6 × 8	75V	±20%	≤600V	10KA	10A	≥10	≤1pF
3R090L- 6 × 8	90V	±20%	≤600V	10KA	10A	≥10	≤1pF
3R150L- 6 × 8	150V	±20%	≤600V	10KA	10A	≥10	≤1pF
3R200L- 6 × 8	200V	±20%	≤700V	10KA	10A	≥10	≤1pF
3R230L- 6 × 8	230V	±20%	≤700V	10KA	10A	≥10	≤1pF
3R300L- 6 × 8	300V	±20%	≤900V	10KA	10A	≥10	≤1pF
3R350L- 6 × 8	350V	±20%	≤1000V	10KA	10A	≥10	≤1pF
3R400L- 6 × 8	400V	±20%	≤1000V	10KA	10A	≥10	≤1pF
3R470L- 6 × 8	470V	±20%	≤1200V	10KA	10A	≥10	≤1pF
3R600L- 6 × 8	600V	±20%	≤1400V	10KA	10A	≥10	≤1pF

- 1) At delivery AQL 0.65 leave II Military Standard 105 E.
- 2) In ionized mode
- 3) Test according to ITU-T Rec.k.12

Specification Status: Draft (mm)

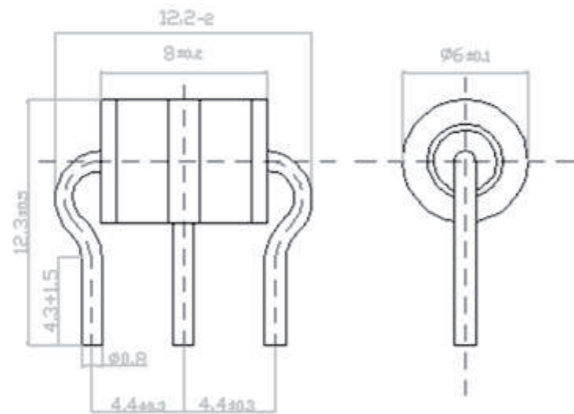

3R***L- 8 × 10 Series Electrical Characteristics (TA = 25 ° C unless otherwise noted)



Part Number	DC Breakdown Voltage	Tolerance	Impulse Spark-over Voltage	Impulse Discharge Current 10hits (5hits each polarity)	AC Discharge Current 5 hits	Insulation Resistance*	Capacitance
	100V/s (V)	of Vs	1KV/μs (V)	8/20μs	50Hz	GΩ	1MHz
3R075L- 8 × 10	75V	±20%	≤600V	10KA	10A	≥10	≤1pF
3R090L- 8 × 10	90V	±20%	≤600V	10KA	10A	≥10	≤1pF
3R150L- 8 × 10	150V	±20%	≤600V	10KA	10A	≥10	≤1pF
3R200L- 8 × 10	200V	±20%	≤700V	10KA	10A	≥10	≤1pF
3R230L- 8 × 10	230V	±20%	≤700V	10KA	10A	≥10	≤1pF
3R300L- 8 × 10	300V	±20%	≤900V	10KA	10A	≥10	≤1pF
3R350L- 8 × 10	350V	±20%	≤1000V	10KA	10A	≥10	≤1pF
3R400L- 8 × 10	400V	±20%	≤1000V	10KA	10A	≥10	≤1pF
3R470L- 8 × 10	470V	±20%	≤1200V	10KA	10A	≥10	≤1pF
3R600L- 8 × 10	600V	±20%	≤1400V	10KA	10A	≥10	≤1pF

- 1) At delivery AQL 0.65 leave II Military Standard 105 E.
- 2) In ionized mode
- 3) Test according to ITU-T Rec.k.12

Specification Status: Draft (mm)

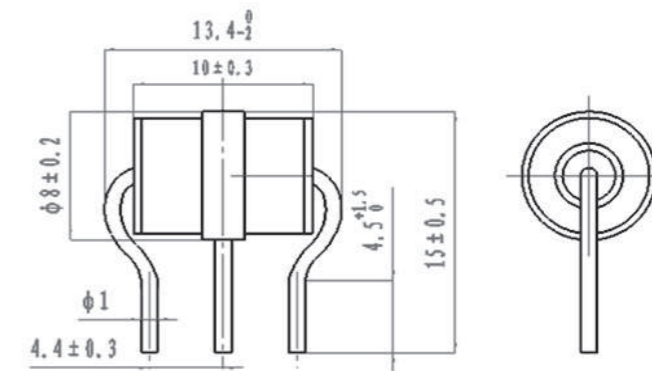

压敏电阻 MOV (Metal Oxide Varistors)

压敏电阻的本身是由氧化锌颗粒组成的矩阵结构。颗粒之间的晶界类似双向 PN 结的电气特性，当低电压时，这些晶界处于高阻抗状态，当电压高时，又会处于击穿状态，是一种非线性器件。

The body of varistor is a matrix structure composed of zinc oxide particles. The grain boundaries between particles are similar to the electrical characteristics of bidirectional PN junctions. When the voltage is low, these grain boundaries are in the high impedance state, and when the voltage is high, they will be in the break-down state, which is a kind of non-linear device.



应用 Application

- ▲ 抑制消费类电子产品及工业用电子设备主电源所窜入的浪涌电流。如 LED 照明、电度表、开关电源、排插等。
Suppresses surge current from the main power supply of consumer electronics and industrial electronic equipment. Such as LED lighting, watt-hour meter, switching power supply, layout and so on.
- ▲ 通讯等有线网络设备窜入的浪涌电流。
The surge current of communication and other wired network equipment.
- ▲ 房舍装置以及瓦斯和油类设施上所装置的电子器材的浪涌保护
Surge protection of electronic equipment installed on buildings and gas and oil facilities
- ▲ 抑制电子线路内发生的浪涌
Restrain surge in electronic circuit
- ▲ 照相器材用于限压开关
Photographic equipment used for voltage limiting switch

产品料号代码 HOW TO ORDER

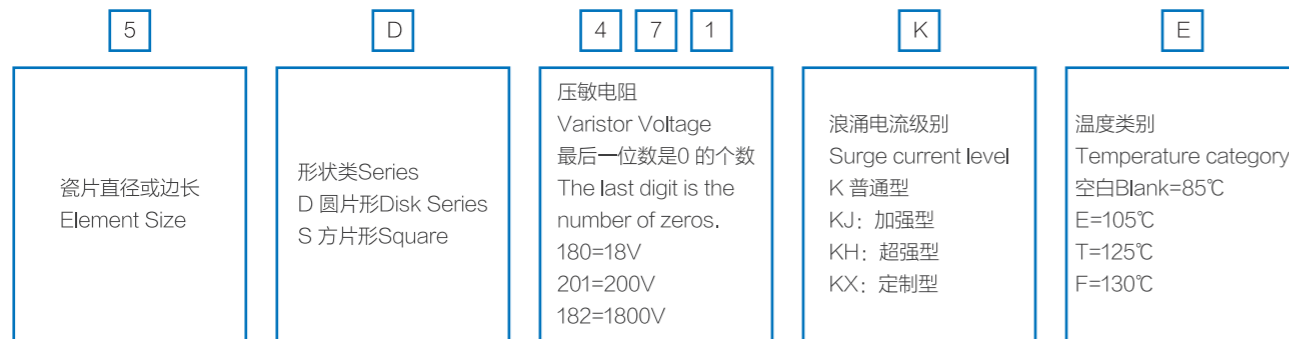

按冲击 8/20 μs 浪涌电流分类 Classification According to 8/20 μs Surge Current

▲ 普通型、KJ 加强型

型号 Part NO.	压敏电压	最大允许使用电压	K 普通型			KJ 加强型		
	V1mA (V)	AC (V)	I _{max} (8/20 μs) (A)	I _n (15 次) (8/20 μs) (A)	能量 (10/1000 μs) (J)	I _{max} (8/20 μs) (A)	I _n (15 次) (8/20 μs) (A)	能量 (10/1000 μs) (J)
5D	82-750	50-400	400	150	2.5-18	800	250	3.5-33
7D	82-820	50-400	1200	500	6.0-43	1750	1000	8.4-7.1
10D	82-1800	50-1000	2500	1500	13-185	3500	1500	18-259
14D	82-1800	50-1000	4500	3000	26-378	6000	13000	31-450
20D	82-1800	50-1000	6500	3000	48-632	10000	5000	67-850
5D	18-68	11-40	100		0.5-2.1	250	150	0.7-2.9
7D	18-68	11-40	250		1.3-5.0	500	250	1.8-7.0
10D	18-68	11-40	500		2.8-11	1000	500	3.9-15
14D	18-68	11-40	1000		5.7-21	2000	1000	6.8-25
20D	18-68	11-40	2000		11-46	3000	1000	13-55

符合国际及国家标准	IEC61051-1 IEC61051-2 IEC61051-2-2 CSA-C22.2 UL1449	GB/T10193 GB/T10194 GB/T10195 No.269.5-17	包含左栏，并增加以下标准： IEC60950-1: 2013/Annex Q GB/4943.1-2011 GB8898-2011 UL1449
-----------	---	--	--

▲ KH 加强型(整机标准)

- 符合整机标准: IEC61000-4-5, GB/T17626.5 《电磁兼容试验和测量技术浪涌(冲击)抗扰度试验》，在使用AC 电压的4 个相位角，每个相位角正负个冲击5 次，总计40 次冲击;
- 冲击峰值
5D:1KV/0.5KA 7D:2KV/1KA
10D:4KV/2KA 14D:6KV/3KA
20D:10KV/5KA
- 电压规格: V1mA≥430V, 也即431 及以上规格;
- 组合波: 开路为电压波1.2/50 μs, 短路为电流波8/20 μs, 叠加AC 电压

▲ KX 定制型

- 雷击要求高于KH 级，比如
A.一次冲击的峰值 (I_{max}) 要求高于KH, 举例: 14D 产品, 要求I_{max}≥10KA
B.浪涌冲击次数 (I_n) 要求冲击次数多, 举例: 14D 产品, 要求6KV/3KA 组合波冲击100 次、500 次……
- 小型化要求: 10D 替代14D, 14D 替代20D, 20D 替代32D……适合SPD 产品应用

压敏电阻 MOV (Metal Oxide Varistors)

压敏电阻的本身是由氧化锌颗粒组成的矩阵结构。颗粒之间的晶界类似双向 PN 结的电气特性，当低电压时，这些晶界处于高阻抗状态，当电压高时，又会处于击穿状态，是一种非线性器件。

The body of varistor is a matrix structure composed of zinc oxide particles. The grain boundaries between particles are similar to the electrical characteristics of bidirectional PN junctions. When the voltage is low, these grain boundaries are in the high impedance state, and when the voltage is high, they will be in the break-down state, which is a kind of non-linear device.



应用 Application

- ▲ 抑制消费类电子产品及工业用电子设备主电源所窜入的浪涌电流。如 LED 照明、电度表、开关电源、排插等。
Suppresses surge current from the main power supply of consumer electronics and industrial electronic equipment. Such as LED lighting, watt-hour meter, switching power supply, layout and so on.
- ▲ 通讯等有线网络设备窜入的浪涌电流。
The surge current of communication and other wired network equipment.
- ▲ 房舍装置以及瓦斯和油类设施上所装置的电子器材的浪涌保护
Surge protection of electronic equipment installed on buildings and gas and oil facilities
- ▲ 抑制电子线路内发生的浪涌
Restrain surge in electronic circuit
- ▲ 照相器材用于限压开关
Photographic equipment used for voltage limiting switch

产品料号代码 HOW TO ORDER

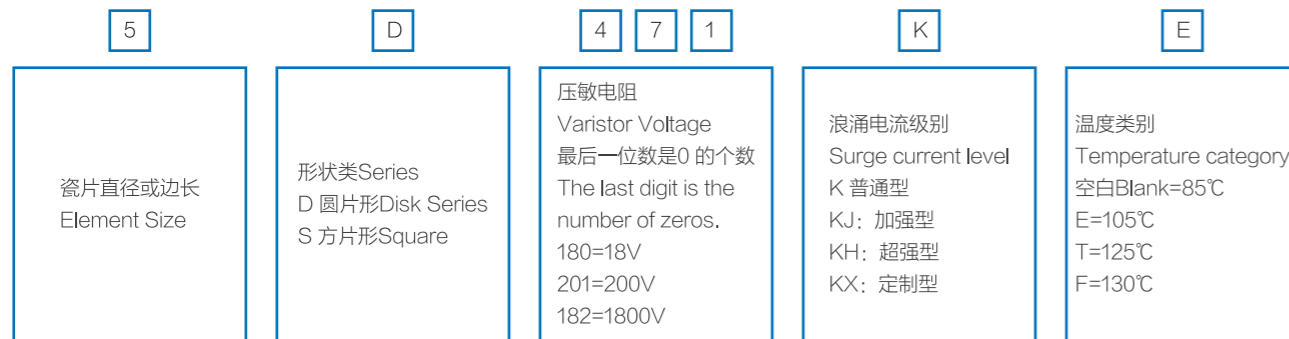

按冲击 8/20 μs 浪涌电流分类 Classification According to 8/20 μs Surge Current

▲ 普通型、KJ 加强型

型号 Part NO.	压敏电压	最大允许使用电压	K 普通型			KJ 加强型		
	V1mA (V)	AC (V)	I _{max} (8/20 μs) (A)	I _n (15 次) (8/20 μs) (A)	能量 (10/1000 μs) (J)	I _{max} (8/20 μs) (A)	I _n (15 次) (8/20 μs) (A)	能量 (10/1000 μs) (J)
5D	82-750	50-400	400	150	2.5-18	800	250	3.5-33
7D	82-820	50-400	1200	500	6.0-43	1750	1000	8.4-7.1
10D	82-1800	50-1000	2500	1500	13-185	3500	1500	18-259
14D	82-1800	50-1000	4500	3000	26-378	6000	13000	31-450
20D	82-1800	50-1000	6500	3000	48-632	10000	5000	67-850
5D	18-68	11-40	100		0.5-2.1	250	150	0.7-2.9
7D	18-68	11-40	250		1.3-5.0	500	250	1.8-7.0
10D	18-68	11-40	500		2.8-11	1000	500	3.9-15
14D	18-68	11-40	1000		5.7-21	2000	1000	6.8-25
20D	18-68	11-40	2000		11-46	3000	1000	13-55

符合国际及国家标准	IEC61051-1 IEC61051-2 IEC61051-2-2 CSA-C22.2 UL1449	GB/T10193 GB/T10194 GB/T10195 No.269.5-17	包含左栏，并增加以下标准： IEC60950-1: 2013/Annex Q GB/4943.1-2011 GB8898-2011 UL1449
-----------	---	--	--

▲ KH 加强型(整机标准)

- 符合整机标准: IEC61000-4-5, GB/T17626.5 《电磁兼容试验和测量技术浪涌(冲击)抗扰度试验》，在使用AC 电压的4 个相位角，每个相位角正负个冲击5 次，总计40 次冲击;
- 冲击峰值
5D:1KV/0.5KA 7D:2KV/1KA
10D:4KV/2KA 14D:6KV/3KA
20D:10KV/5KA
- 电压规格: V1mA≥430V, 也即431 及以上规格;
- 组合波: 开路为电压波1.2/50 μs, 短路为电流波8/20 μs, 叠加AC 电压

▲ KX 定制型

- 雷击要求高于KH 级，比如
A.一次冲击的峰值 (I_{max}) 要求高于KH, 举例: 14D 产品, 要求I_{max}≥10KA
B.浪涌冲击次数 (I_n) 要求冲击次数多, 举例: 14D 产品, 要求6KV/3KA 组合波冲击100 次、500 次……
- 小型化要求: 10D 替代14D, 14D 替代20D, 20D 替代32D……适合SPD 产品应用

5D K 系列电气参数 5D K Series Electrical Parameters

型号规格 Part NO.	Varistor Voltage		Maximum allowable voltage		Maximum Limited Voltage	Withstanding Surge current (1.2/50 μ s&8/20 μ s)		Rated Wattage	Energy (10/1000 μ s)	Typical Capacitance
	V1mA		AC	DC	V _{5A}	I _{max}	I _n	(W)	(J)	1kHz
	(V)		(V)		(V)	(A)				(pF)
5D180K	18	16-20	11	14	40	100	—	0.01	0.5	2400
5D220K	22	20-24	14	18	48	100	—	0.01	0.7	1800
5D270K	27	24-30	17	22	60	100	—	0.01	0.8	1500
5D330K	33	30-36	20	26	73	100	—	0.01	1.0	1200
5D390K	39	35-43	25	31	86	100	—	0.01	1.2	1000
5D470K	47	42-52	30	38	104	100	—	0.01	1.5	850
5D560K	56	50-62	35	45	123	100	—	0.01	1.8	700
5D680K	68	61-75	40	56	150	100	—	0.01	2.1	560
5D820K	82	74-90	50	65	145	400	150	0.1	2.5	480
5D101K	100	90-100	60	85	175	400	150	0.1	3.2	420
5D121K	120	108-132	75	100	210	400	150	0.1	4.0	360
5D151K	150	135-165	95	125	260	400	150	0.1	4.8	280
5D181K	180	162-198	115	150	320	400	150	0.1	5.9	200
5D201K	200	180-220	130	170	355	400	150	0.1	6.5	160
5D221K	220	198-242	140	180	380	400	150	0.1	7.0	110
5D241K	240	216-264	150	200	415	400	150	0.1	8.0	85
5D271K	270	243-297	175	225	475	400	150	0.1	8.5	75
5D301K	300	270-330	195	250	525	400	150	0.1	8.5	75
5D331K	330	297-363	210	275	575	400	150	0.1	9.2	75
5D361K	360	324-396	230	300	620	400	150	0.1	10	70
5D391K	390	351-429	250	320	675	400	150	0.1	12	70
5D431K	430	387-473	275	350	745	400	150	0.1	13	65
5D471K	470	423-517	300	385	810	400	150	0.1	15	55
5D511K	510	459-561	320	418	882	400	150	0.1	16	55
5D561K	560	504-616	350	460	968	400	150	0.1	18	50
5D621K	620	558-682	385	505	1072	400	150	0.1	18	45
5D681K	680	612-748	420	560	1176	400	150	0.1	18	40
5D751K	750	675-825	460	615	1300	400	150	0.1	18	35

注: 180K 至680K 最大限制电压测试电流是5A

The maximum limit voltage test current K 180K to 680 is 5A.

5D KJ 系列电气参数 5D KJ Series Electrical Parameters

型号规格 Part NO.	Varistor Voltage		Maximum allowable voltage		Maximum Limited Voltage	Withstanding Surge current (1.2/50 μ s&8/20 μ s)		Rated Wattage	Energy (10/1000 μ s)	Typical Capacitance
	V1mA		AC	DC	V _{5A}	I _{max}	I _n	(W)	(J)	1kHz
	(V)		(V)		(V)	(A)				(pF)
5D180KJ	18	16-20	11	14	40	250	150	0.01	0.7	2400
5D220KJ	22	20-24	14	18	48	250	150	0.01	1.0	1800
5D270KJ	27	24-30	17	22	60	250	150	0.01	1.1	1500
5D330KJ	33	30-36	20	26	73	250	150	0.01	1.4	1200
5D390KJ	39	35-43	25	31	86	250	150	0.01	1.7	1000
5D470KJ	47	42-52	30	38	104	250	150	0.01	2.1	850
5D560KJ	56	50-62	35	45	123	250	150	0.01	2.5	700
5D680KJ	68	61-75	40	56	150	250	150	0.01	2.9	560
5D820K J	82	74-90	50	65	145	800	250	0.1	3.5	480
5D101KJ	100	90-100	60	85	175	800	250	0.1	4.5	420
5D121KJ	120	108-132	75	100	210	800	250	0.1	5.6	360
5D151KJ	150	135-165	95	125	260	800	250	0.1	6.7	280
5D181KJ	180	162-198	115	150	320	800	250	0.1	8.5	200
5D201KJ	200	180-220	130	170	355	800	250	0.1	10.5	160
5D221KJ	220	198-242	140	180	380	800	250	0.1	11.5	110
5D241KJ	240	216-264	150	200	415	800	250	0.1	12.5	85
5D271KJ	270	243-297	175	225	475	800	250	0.1	14	75
5D301KJ	300	270-330	195	250	525	800	250	0.1	16	75
5D331KJ	330	297-363	210	275	575	800	250	0.1	17	75
5D361K J	360	324-396	230	300	620	800	250	0.1	18.5	70
5D391KJ	390	351-429	250	320	675	800	250	0.1	20.0	70
5D431KJ	430	387-473	275	350	745	800	250	0.1	23.0	65
5D471KJ	470	423-517	300	385	810	800	250	0.1	24.5	55
5D511KJ	510	459-561	320	418	882	800	250	0.1	27.0	55
5D561KJ	560	504-616	350	460	968	800	250	0.1	27.5	50
5D621KJ	620	558-682	385	505	1072	800	250	0.1	29.5	45
5D681KJ	680	612-748	420	560	1176	800	250	0.1	31.0	40
5D751KJ	750	675-825	460	615	1300	800	250	0.1	33.0	35

注: 180K 至680K 最大限制电压测试电流是5A

The maximum limit voltage test current K 180K to 680 is 5A.

5D K 系列电气参数 5D K Series Electrical Parameters

型号规格 Part NO.	Varistor Voltage		Maximum allowable voltage		Maximum Limited Voltage	Withstanding Surge current (1.2/50 μs & 8/20 μs)		Rated Wattage (W)	Energy (10/1000 μs) (J)	Typical Capacitance
	V1mA		AC	DC	V5A	I _{max}	I _n			1kHz
	(V)		(V)		(V)	(A)		(pF)		
5D180K	18	16-20	11	14	40	100	—	0.01	0.5	2400
5D220K	22	20-24	14	18	48	100	—	0.01	0.7	1800
5D270K	27	24-30	17	22	60	100	—	0.01	0.8	1500
5D330K	33	30-36	20	26	73	100	—	0.01	1.0	1200
5D390K	39	35-43	25	31	86	100	—	0.01	1.2	1000
5D470K	47	42-52	30	38	104	100	—	0.01	1.5	850
5D560K	56	50-62	35	45	123	100	—	0.01	1.8	700
5D680K	68	61-75	40	56	150	100	—	0.01	2.1	560
5D820K	82	74-90	50	65	145	400	150	0.1	2.5	480
5D101K	100	90-100	60	85	175	400	150	0.1	3.2	420
5D121K	120	108-132	75	100	210	400	150	0.1	4.0	360
5D151K	150	135-165	95	125	260	400	150	0.1	4.8	280
5D181K	180	162-198	115	150	320	400	150	0.1	5.9	200
5D201K	200	180-220	130	170	355	400	150	0.1	6.5	160
5D221K	220	198-242	140	180	380	400	150	0.1	7.0	110
5D241K	240	216-264	150	200	415	400	150	0.1	8.0	85
5D271K	270	243-297	175	225	475	400	150	0.1	8.5	75
5D301K	300	270-330	195	250	525	400	150	0.1	8.5	75
5D331K	330	297-363	210	275	575	400	150	0.1	9.2	75
5D361K	360	324-396	230	300	620	400	150	0.1	10	70
5D391K	390	351-429	250	320	675	400	150	0.1	12	70
5D431K	430	387-473	275	350	745	400	150	0.1	13	65
5D471K	470	423-517	300	385	810	400	150	0.1	15	55
5D511K	510	459-561	320	418	882	400	150	0.1	16	55
5D561K	560	504-616	350	460	968	400	150	0.1	18	50
5D621K	620	558-682	385	505	1072	400	150	0.1	18	45
5D681K	680	612-748	420	560	1176	400	150	0.1	18	40
5D751K	750	675-825	460	615	1300	400	150	0.1	18	35

注: 180K 至680K 最大限制电压测试电流是5A

The maximum limit voltage test current K 180K to 680 is 5A.

5D KJ 系列电气参数 5D KJ Series Electrical Parameters

型号规格 Part NO.	Varistor Voltage		Maximum allowable voltage		Maximum Limited Voltage	Withstanding Surge current (1.2/50 μs & 8/20 μs)		Rated Wattage (W)	Energy (10/1000 μs) (J)	Typical Capacitance
	V1mA		AC	DC	V5A	I _{max}	I _n			1kHz
	(V)		(V)		(V)	(A)		(pF)		
5D180KJ	18	16-20	11	14	40	250	150	0.01	0.7	2400
5D220KJ	22	20-24	14	18	48	250	150	0.01	1.0	1800
5D270KJ	27	24-30	17	22	60	250	150	0.01	1.1	1500
5D330KJ	33	30-36	20	26	73	250	150	0.01	1.4	1200
5D390KJ	39	35-43	25	31	86	250	150	0.01	1.7	1000
5D470KJ	47	42-52	30	38	104	250	150	0.01	2.1	850
5D560KJ	56	50-62	35	45	123	250	150	0.01	2.5	700
5D680KJ	68	61-75	40	56	150	250	150	0.01	2.9	560
5D820K J	82	74-90	50	65	145	800	250	0.1	3.5	480
5D101KJ	100	90-100	60	85	175	800	250	0.1	4.5	420
5D121KJ	120	108-132	75	100	210	800	250	0.1	5.6	360
5D151KJ	150	135-165	95	125	260	800	250	0.1	6.7	280
5D181KJ	180	162-198	115	150	320	800	250	0.1	8.5	200
5D201KJ	200	180-220	130	170	355	800	250	0.1	10.5	160
5D221KJ	220	198-242	140	180	380	800	250	0.1	11.5	110
5D241KJ	240	216-264	150	200	415	800	250	0.1	12.5	85
5D271KJ	270	243-297	175	225	475	800	250	0.1	14	75
5D301KJ	300	270-330	195	250	525	800	250	0.1	16	75
5D331KJ	330	297-363	210	275	575	800	250	0.1	17	75
5D361K J	360	324-396	230	300	620	800	250	0.1	18.5	70
5D391KJ	390	351-429	250	320	675	800	250	0.1	20.0	70
5D431KJ	430	387-473	275	350	745	800	250	0.1	23.0	65
5D471KJ	470	423-517	300	385	810	800	250	0.1	24.5	55
5D511KJ	510	459-561	320	418	882	800	250	0.1	27.0	55
5D561KJ	560	504-616	350	460	968	800	250	0.1	27.5	50
5D621KJ	620	558-682	385	505	1072	800	250	0.1	29.5	45
5D681KJ	680	612-748	420	560	1176	800	250	0.1	31.0	40
5D751KJ	750	675-825	460	615	1300	800	250	0.1	33.0	35

注: 180K 至680K 最大限制电压测试电流是5A

The maximum limit voltage test current K 180K to 680 is 5A.



5D KH 系列电气参数 5D KH Series Electrical Parameters

型号规格 Part NO.	Varistor Voltage		Maximum allowable voltage		Maximum Limited Voltage	Withstanding Surge current (1.2/50 μs & 8/20 μs)		Rated Wattage	Energy (10/1000 μs)	Typical Capacitance
	V1mA		AC	DC	V5A	I _{max}	I _n	(W)	(J)	1KHz
	(V)		(V)	(V)	(V)	(A)				(pF)
5D431KH	430	387-473	275	350	745	800	1KV/0.5KA	0.1	23.0	65
5D471KH	470	423-517	300	385	810	800	1KV/0.5KA	0.1	24.5	55
5D551KH	510	459-561	320	418	882	800	1KV/0.5KA	0.1	27.0	55
5D561KH	560	504-616	350	460	968	800	1KV/0.5KA	0.1	27.5	50
5D621KH	620	558-682	385	505	1072	800	1KV/0.5KA	0.1	29.5	45

产品尺寸 单位 (Unit) :mm

产品外形 Product shape	系列 Series	压敏电压 Varistor voltage	厚度 T max
	5D	18V-39V	3.8
		47V-68V	4.3
		82V-150V	3.8
		180V-270V	4.2
		330V-390V	4.8
		430V-560V	5.6
		620V-750V	6.4

7D K 系列 电气参数 7D K Series Electrical Parameters

型号规格 Part NO.	Varistor Voltage		Maximum allowable voltage		Maximum Limited Voltage	Withstanding Surge current (1.2/50 μs & 8/20 μs)		Rated Wattage	Energy (10/1000 μs)	Typical Capacitance
	V1mA		AC	DC	V25A	I _{max}	I _n	(W)	(J)	1KHz
	(V)		(V)	(V)	(V)	(A)				(pF)
7D180K	18	16-20	11	14	38	250	—	0.02	1.3	3500
7D220K	22	20-24	14	18	43	250	—	0.02	1.7	2800
7D270K	27	24-30	17	22	53	250	—	0.02	2.0	2200
7D330K	33	30-36	20	26	65	250	—	0.02	2.4	1800
7D390K	39	35-43	25	31	77	250	—	0.02	2.8	1450
7D470K	47	42-52	30	38	93	250	—	0.02	3.5	1150
7D560K	56	50-62	35	45	110	250	—	0.02	4.1	1050
7D680K	68	61-75	40	56	135	250	—	0.02	5.0	970
7D820K	82	74-90	50	65	135	1200	500	0.25	6.0	930
7D101K	100	90-100	60	85	165	1200	500	0.25	7.4	860
7D121K	120	108-132	75	100	200	1200	500	0.25	8.0	670
7D151K	150	135-165	95	125	250	1200	500	0.25	10	490
7D181K	180	162-198	115	150	300	1200	500	0.25	12	330
7D201K	200	180-220	130	170	340	1200	500	0.25	14	240
7D221K	220	198-242	140	180	360	1200	500	0.25	15	190
7D241K	240	216-264	150	200	395	1200	500	0.25	16	165
7D271K	270	243-297	175	225	455	1200	500	0.25	19	150
7D301K	300	270-330	195	250	500	1200	500	0.25	22	135
7D331K	330	297-363	210	275	550	1200	500	0.25	24	130
7D361K	360	324-396	230	300	595	1200	500	0.25	26	125
7D391K	390	351-429	250	320	650	1200	500	0.25	26	105
7D431K	430	387-473	275	350	710	1200	500	0.25	29	100
7D471K	470	423-517	300	385	775	1200	500	0.25	31	90
7D511K	510	459-561	320	418	845	1200	500	0.25	34	80
7D561K	560	504-616	350	460	930	1200	500	0.25	34	75
7D621K	620	558-682	385	505	1025	1200	500	0.25	36	70
7D681K	680	612-748	420	560	1120	1200	500	0.25	36	65
7D751K	750	675-825	460	615	1240	1200	500	0.25	39	61
7D781K	780	702-858	485	640	1290	1200	500	0.25	41	54
7D821K	820	738-902	510	670	1355	1200	500	0.25	43	48

注: 180K 至680K 最大限制电压测试电流是25A
The maximum limit voltage test current K 180K to 680 is 25A.

5D KH 系列电气参数 5D KH Series Electrical Parameters

型号规格 Part NO.	Varistor Voltage		Maximum allowable voltage		Maximum Limited Voltage	Withstanding Surge current (1.2/50 μs & 8/20 μs)		Rated Wattage	Energy (10/1000 μs)	Typical Capacitance
	V1mA		AC	DC	V5A	I _{max}	I _n	(W)	(J)	1KHz
	(V)		(V)	(V)	(V)	(A)				(pF)
5D431KH	430	387-473	275	350	745	800	1KV/0.5KA	0.1	23.0	65
5D471KH	470	423-517	300	385	810	800	1KV/0.5KA	0.1	24.5	55
5D551KH	510	459-561	320	418	882	800	1KV/0.5KA	0.1	27.0	55
5D561KH	560	504-616	350	460	968	800	1KV/0.5KA	0.1	27.5	50
5D621KH	620	558-682	385	505	1072	800	1KV/0.5KA	0.1	29.5	45

产品尺寸 单位 (Unit) :mm

产品外形 Product shape	系列 Series	压敏电压 Varistor voltage	厚度 T max
	5D	18V-39V	3.8
		47V-68V	4.3
		82V-150V	3.8
		180V-270V	4.2
		330V-390V	4.8
		430V-560V	5.6
		620V-750V	6.4

7D K 系列 电气参数 7D K Series Electrical Parameters

型号规格 Part NO.	Varistor Voltage		Maximum allowable voltage		Maximum Limited Voltage	Withstanding Surge current (1.2/50 μs & 8/20 μs)		Rated Wattage	Energy (10/1000 μs)	Typical Capacitance
	V1mA		AC	DC	V25A	I _{max}	I _n	(W)	(J)	1KHz
	(V)		(V)	(V)	(V)	(A)				(pF)
7D180K	18	16-20	11	14	38	250	—	0.02	1.3	3500
7D220K	22	20-24	14	18	43	250	—	0.02	1.7	2800
7D270K	27	24-30	17	22	53	250	—	0.02	2.0	2200
7D330K	33	30-36	20	26	65	250	—	0.02	2.4	1800
7D390K	39	35-43	25	31	77	250	—	0.02	2.8	1450
7D470K	47	42-52	30	38	93	250	—	0.02	3.5	1150
7D560K	56	50-62	35	45	110	250	—	0.02	4.1	1050
7D680K	68	61-75	40	56	135	250	—	0.02	5.0	970
7D820K	82	74-90	50	65	135	1200	500	0.25	6.0	930
7D101K	100	90-100	60	85	165	1200	500	0.25	7.4	860
7D121K	120	108-132	75	100	200	1200	500	0.25	8.0	670
7D151K	150	135-165	95	125	250	1200	500	0.25	10	490
7D181K	180	162-198	115	150	300	1200	500	0.25	12	330
7D201K	200	180-220	130	170	340	1200	500	0.25	14	240
7D221K	220	198-242	140	180	360	1200	500	0.25	15	190
7D241K	240	216-264	150	200	395	1200	500	0.25	16	165
7D271K	270	243-297	175	225	455	1200	500	0.25	19	150
7D301K	300	270-330	195	250	500	1200	500	0.25	22	135
7D331K	330	297-363	210	275	550	1200	500	0.25	24	130
7D361K	360	324-396	230	300	595	1200	500	0.25	26	125
7D391K	390	351-429	250	320	650	1200	500	0.25	26	105
7D431K	430	387-473	275	350	710	1200	500	0.25	29	100
7D471K	470	423-517	300	385	775	1200	500	0.25	31	90
7D511K	510	459-561	320	418	845	1200	500	0.25	34	80
7D561K	560	504-616	350	460	930	1200	500	0.25	34	75
7D621K	620	558-682	385	505	1025	1200	500	0.25	36	70
7D681K	680	612-748	420	560	1120	1200	500	0.25	36	65
7D751K	750	675-825	460	615	1240	1200	500	0.25	39	61
7D781K	780	702-858	485	640	1290	1200	500	0.25	41	54
7D821K	820	738-902	510	670	1355	1200	500	0.25	43	48

注: 180K 至680K 最大限制电压测试电流是25A
The maximum limit voltage test current K 180K to 680 is 25A.

MOV

7D KJ 系列电气参数 7D KJ Series Electrical Parameters

型号规格 Part NO.	Varistor Voltage		Maximum allowable voltage		Maximum Limited Voltage	Withstanding Surge current (1.2/50 μs & 8/20 μs)		Rated Wattage	Energy (10/1000 μs)	Typical Capacitance
	V1mA		AC	DC	V25A	I _{max}	I _n	(W)	(J)	1KHz
	(V)		(V)		(V)	(A)				(pF)
7D180KJ	18	16-20	11	14	38	500	250	0.02	1.8	3500
7D220KJ	22	20-24	14	18	43	500	252	0.02	2.4	2800
7D270KJ	27	24-30	17	22	53	500	250	0.02	2.8	2200
7D330KJ	33	30-36	20	26	65	500	250	0.02	3.4	1800
7D390KJ	39	35-43	25	31	77	500	250	0.02	3.9	1450
7D470KJ	47	42-52	30	38	93	500	250	0.02	4.9	1150
7D560KJ	56	50-62	35	45	110	500	250	0.02	5.7	1050
7D680KJ	68	61-75	40	56	135	500	250	0.02	7.0	970
7D820K J	82	74-90	50	65	135	1750	1000	0.25	8.4	930
7D101KJ	100	90-100	60	85	165	1750	1000	0.25	10	860
7D121KJ	120	108-132	75	100	200	1750	1000	0.25	12	670
7D151KJ	150	135-165	95	125	250	1750	1000	0.25	15	490
7D181KJ	180	162-198	115	150	300	1750	1000	0.25	19	330
7D201KJ	200	180-220	130	170	340	1750	1000	0.25	21	240
7D221KJ	220	198-242	140	180	360	1750	1000	0.25	13	190
7D241KJ	240	216-264	150	200	395	1750	1000	0.25	15	165
7D271KJ	270	243-297	175	225	455	1750	1000	0.25	18	150
7D301KJ	300	270-330	195	250	500	1750	1000	0.25	32	135
7D331KJ	330	297-363	210	275	550	1750	1000	0.25	34	130
7D361K J	360	324-396	230	300	595	1750	1000	0.25	37	125
7D391KJ	390	351-429	250	320	650	1750	1000	0.25	40	105
7D431KJ	430	387-473	275	350	710	1750	1000	0.25	46	100
7D471KJ	470	423-517	300	385	775	1750	1000	0.25	49	90
7D511KJ	510	459-561	320	418	845	1750	1000	0.25	54	80
7D561KJ	560	504-616	350	460	930	1750	1000	0.25	55	75
7D621KJ	620	558-682	385	505	1025	1750	1000	0.25	59	70
7D681KJ	680	612-748	420	560	1120	1750	1000	0.25	62	65
7D751KJ	750	675-825	460	615	1240	1750	1000	0.25	66	61
7D781KJ	780	702-858	485	640	1290	1750	1000	0.25	68	54
7D821KJ	820	738-902	510	670	1355	1750	1000	0.25	71	48

注: 180K 至680K 最大限制电压测试电流是25A
The maximum limit voltage test current K 180K to 680 is 25A.

7D KH 系列 电气参数 7D KH Series Electrical Parameters

型号规格 Part NO.	Varistor Voltage		Maximum allowable voltage		Maximum Limited Voltage	Withstanding Surge current (1.2/50 μs & 8/20 μs)		Rated Wattage	Energy (10/1000 μs)	Typical Capacitance
	V1mA		AC	DC	V25A	I _{max}	I _n	(W)	(J)	1KHz
	(V)		(V)		(V)	(A)				(pF)
7D431KH	430	387-473	275	350	710	1750	2KV/1KA	0.25	46	100
7D471KH	470	423-517	300	385	775	1750	2KV/1KA	0.25	49	90
7D551KH	510	459-561	320	418	842	1750	2KV/1KA	0.25	54	80
7D561KH	560	504-616	350	460	920	1750	2KV/1KA	0.25	55	75
7D621KH	620	558-682	385	505	1025	1750	2KV/1KA	0.25	59	70
7D681KH	680	612-748	420	560	1120	1750	2KV/1KA	0.25	62	65
7D751KH	750	675-825	460	615	1240	1750	2KV/1KA	0.25	66	61
7D781KH	780	702-858	485	640	1290	1750	2KV/1KA	0.25	68	54
7D821KH	820	738-902	510	670	1355	1750	2KV/1KA	0.25	71	48

产品尺寸 单位 (Unit) :mm

产品外形 Product shape	系列 Series	压敏电压 Varistor voltage	厚度 T max
	7D	18V-39V	3.9
		47V-68V	4.4
		82V-150V	3.9
		180V-270V	4.3
		330V-390V	4.9
		430V-560V	5.7
		620V-750V	6.5
		820V	6.8

MOV

7D KJ 系列电气参数 7D KJ Series Electrical Parameters

型号规格 Part NO.	Varistor Voltage		Maximum allowable voltage		Maximum Limited Voltage	Withstanding Surge current (1.2/50 μs & 8/20 μs)		Rated Wattage	Energy (10/1000 μs)	Typical Capacitance
	V1mA		AC	DC	V25A	I _{max}	I _n	(W)	(J)	1KHz
	(V)		(V)		(V)	(A)				(pF)
7D180KJ	18	16-20	11	14	38	500	250	0.02	1.8	3500
7D220KJ	22	20-24	14	18	43	500	252	0.02	2.4	2800
7D270KJ	27	24-30	17	22	53	500	250	0.02	2.8	2200
7D330KJ	33	30-36	20	26	65	500	250	0.02	3.4	1800
7D390KJ	39	35-43	25	31	77	500	250	0.02	3.9	1450
7D470KJ	47	42-52	30	38	93	500	250	0.02	4.9	1150
7D560KJ	56	50-62	35	45	110	500	250	0.02	5.7	1050
7D680KJ	68	61-75	40	56	135	500	250	0.02	7.0	970
7D820K J	82	74-90	50	65	135	1750	1000	0.25	8.4	930
7D101KJ	100	90-100	60	85	165	1750	1000	0.25	10	860
7D121KJ	120	108-132	75	100	200	1750	1000	0.25	12	670
7D151KJ	150	135-165	95	125	250	1750	1000	0.25	15	490
7D181KJ	180	162-198	115	150	300	1750	1000	0.25	19	330
7D201KJ	200	180-220	130	170	340	1750	1000	0.25	21	240
7D221KJ	220	198-242	140	180	360	1750	1000	0.25	13	190
7D241KJ	240	216-264	150	200	395	1750	1000	0.25	15	165
7D271KJ	270	243-297	175	225	455	1750	1000	0.25	18	150
7D301KJ	300	270-330	195	250	500	1750	1000	0.25	32	135
7D331KJ	330	297-363	210	275	550	1750	1000	0.25	34	130
7D361K J	360	324-396	230	300	595	1750	1000	0.25	37	125
7D391KJ	390	351-429	250	320	650	1750	1000	0.25	40	105
7D431KJ	430	387-473	275	350	710	1750	1000	0.25	46	100
7D471KJ	470	423-517	300	385	775	1750	1000	0.25	49	90
7D511KJ	510	459-561	320	418	845	1750	1000	0.25	54	80
7D561KJ	560	504-616	350	460	930	1750	1000	0.25	55	75
7D621KJ	620	558-682	385	505	1025	1750	1000	0.25	59	70
7D681KJ	680	612-748	420	560	1120	1750	1000	0.25	62	65
7D751KJ	750	675-825	460	615	1240	1750	1000	0.25	66	61
7D781KJ	780	702-858	485	640	1290	1750	1000	0.25	68	54
7D821KJ	820	738-902	510	670	1355	1750	1000	0.25	71	48

注: 180K 至680K 最大限制电压测试电流是25A
The maximum limit voltage test current K 180K to 680 is 25A.

7D KH 系列 电气参数 7D KH Series Electrical Parameters

型号规格 Part NO.	Varistor Voltage		Maximum allowable voltage		Maximum Limited Voltage	Withstanding Surge current (1.2/50 μs & 8/20 μs)		Rated Wattage	Energy (10/1000 μs)	Typical Capacitance
	V1mA		AC	DC	V25A	I _{max}	I _n	(W)	(J)	1KHz
	(V)		(V)		(V)	(A)				(pF)
7D431KH	430	387-473	275	350	710	1750	2KV/1KA	0.25	46	100
7D471KH	470	423-517	300	385	775	1750	2KV/1KA	0.25	49	90
7D551KH	510	459-561	320	418	842	1750	2KV/1KA	0.25	54	80
7D561KH	560	504-616	350	460	920	1750	2KV/1KA	0.25	55	75
7D621KH	620	558-682	385	505	1025	1750	2KV/1KA	0.25	59	70
7D681KH	680	612-748	420	560	1120	1750	2KV/1KA	0.25	62	65
7D751KH	750	675-825	460	615	1240	1750	2KV/1KA	0.25	66	61
7D781KH	780	702-858	485	640	1290	1750	2KV/1KA	0.25	68	54
7D821KH	820	738-902	510	670	1355	1750	2KV/1KA	0.25	71	48

产品尺寸 单位 (Unit) :mm

产品外形 Product shape	系列 Series	压敏电压 Varistor voltage	厚度 T max
	7D	18V-39V	3.9
		47V-68V	4.4
		82V-150V	3.9
		180V-270V	4.3
		330V-390V	4.9
		430V-560V	5.7
		620V-750V	6.5
		820V	6.8

10D K 系列 电气参数 10D K Series Electrical Parameters

型号规格 Part NO.	Varistor Voltage		Maximum allowable voltage		Maximum Limited Voltage	Withstanding Surge current (1.2/50 μ s&8/20 μ s)		Rated Wattage	Energy (10/1000 μ s)	Typical Capacitance
	V1mA		AC	DC	V25A	I _{max}	I _n	(W)	(J)	1kHz
	(V)		(V)		(V)	(A)				(pF)
10D180K	18	16-20	11	14	38	500	—	0.05	2.8	6500
10D220K	22	20-24	14	18	43	500	—	0.05	3.5	5000
10D270K	27	24-30	17	22	53	500	—	0.05	4.2	4200
10D330K	33	30-36	20	26	65	500	—	0.05	5.2	3700
10D390K	39	35-43	25	31	77	500	—	0.05	6.2	3300
10D470K	47	42-52	30	38	93	500	—	0.05	7.4	2900
10D560K	56	50-62	35	45	110	500	—	0.05	8.8	2500
10D680K	68	61-75	40	56	135	500	—	0.05	11	2100
10D820K	82	74-90	50	65	135	2500	1500	0.4	13	1700
10D101K	100	90-100	60	85	165	2500	1500	0.4	16	1500
10D121K	120	108-132	75	100	200	2500	1500	0.4	19	1300
10D151K	150	135-165	95	125	250	2500	1500	0.4	24	1000
10D181K	180	162-198	115	150	300	2500	1500	0.4	28	770
10D201K	200	185-225	130	170	340	2500	1500	0.4	32	560
10D221K	220	198-242	140	180	360	2500	1500	0.4	35	440
10D241K	240	216-264	150	200	395	2500	1500	0.4	38	410
10D271K	270	243-297	175	225	455	2500	1500	0.4	43	380
10D301K	300	270-330	195	250	500	2500	1500	0.4	47	340
10D331K	330	297-363	215	275	550	2500	1500	0.4	52	330
10D361K	360	324-396	230	300	595	2500	1500	0.4	57	310
10D391K	390	351-429	250	320	650	2500	1500	0.4	61	290
10D431K	430	387-473	275	350	710	2500	1500	0.4	68	270
10D471K	470	423-517	300	385	775	2500	1500	0.4	74	240
10D511K	510	459-561	320	410	845	2500	1500	0.4	74	230
10D561K	560	504-616	350	455	930	2500	1500	0.4	74	230
10D621K	620	558-682	385	505	1025	2500	1500	0.4	74	190
10D681K	680	612-748	420	560	1120	2500	1500	0.4	74	170
10D751K	750	657-825	460	615	1240	2500	1500	0.4	75	160
10D781K	780	702-858	485	640	1290	2500	1500	0.4	78	160
10D821K	820	738-902	510	670	1355	2500	1500	0.4	85	160
10D911K	910	819-1001	550	745	1500	2500	1500	0.4	93	150
10D951K	950	855-1045	580	780	1570	2500	1500	0.4	97	130
10D102K	1000	900-1100	625	825	1650	2500	1500	0.4	102	120
10D112K	1100	990-1210	680	895	1815	2500	1500	0.4	115	110
10D152K	1500	1350-1650	900	1220	2475	2500	1500	0.4	155	100
10D182K	1800	1620-1980	1000	1465	2970	2500	1500	0.4	185	80

注：180K 至680K 最大限制电压测试电流是25A
The maximum limit voltage test current K 180K to 680 is 25A.

10D KJ 系列 电气参数 10D KJ Series Electrical Parameters

型号规格 Part NO.	Varistor Voltage		Maximum allowable voltage		Maximum Limited Voltage	Withstanding Surge current (1.2/50 μ s&8/20 μ s)		Rated Wattage	Energy (10/1000 μ s)	Typical Capacitance
	V1mA		AC	DC	V25A	I _{max}	I _n	(W)	(J)	1kHz
	(V)		(V)		(V)	(A)				(pF)
10D180KJ	18	16-20	11	14	38	1000	500	0.05	3.9	6500
10D220KJ	22	20-24	14	18	43	1000	500	0.05	4.9	5000
10D270KJ	27	24-30	17	22	53	1000	500	0.05	5.9	4200
10D330KJ	33	30-36	20	26	65	1000	500	0.05	7.3	3700
10D390KJ	39	35-43	25	31	77	1000	500	0.05	8.7	3300
10D470KJ	47	42-52	30	38	93	1000	500	0.05	10	2900
10D560KJ	56	50-62	35	45	110	1000	500	0.05	12	2500
10D680KJ	68	61-75	40	56	135	1000	500	0.05	15	2100
10D820KJ	82	74-90	50	65	135	3500	1500	0.4	18	1700
10D101KJ	100	90-100	60	85	165	3500	1500	0.4	22	1500
10D121KJ	120	108-132	75	100	200	3500	1500	0.4	27	1300
10D151KJ	150	135-165	95	125	250	3500	1500	0.4	34	1000
10D181KJ	180	162-198	115	150	300	3500	1500	0.4	47	770
10D201KJ	200	185-225	130	170	340	3500	1500	0.4	52	560
10D221KJ	220	198-242	140	180	360	3500	1500	0.4	58	440
10D241KJ	240	216-264	150	200	395	3500	1500	0.4	64	410
10D271KJ	270	243-297	175	225	455	3500	1500	0.4	67	380
10D301KJ	300	270-330	195	250	500	3500	1500	0.4	70	340
10D331KJ	330	297-363	215	275	550	3500	1500	0.4	72	330
10D361KJ	360	324-396	230	300	595	3500	1500	0.4	76	310
10D391KJ	390	351-429	250	320	650	3500	1500	0.4	82	290
10D431KJ	430	387-473	275	350	710	3500	1500	0.4	93	270
10D471KJ	470	423-517	300	385	775	3500	1500	0.4	99	240
10D511KJ	510	459-561	320	410	845	3500	1500	0.4	107	230
10D561KJ	560	504-616	350	455	930	3500	1500	0.4	113	230
10D621KJ	620	558-682	385	505	1025	3500	1500	0.4	125	190
10D681KJ	680	612-748	420	560	1120	3500	1500	0.4	128	170
10D751KJ	750	657-825	460	615	1240	3500	1500	0.4	134	160
10D781KJ	780	702-858	485	640	1290	3500	1500	0.4	139	160
10D821KJ	820	738-902	510	670	1355	3500	1500	0.4	146	160
10D911KJ	910	819-1001	550	745	1500	3500	1500	0.4	152	150
10D951KJ	950	855-1045	580	780	1570	3500	1500	0.4	158	130
10D102KJ	1000	900-1100	625	825	1650	3500	1500	0.4	170	120
10D112KJ	1100	990-1210	680	895	1815	3500	1500	0.4	180	110
10D152KJ	1500	1350-1650	900	1220	2475	3500	1500	0.4	217	100
10D182KJ	1800	1620-1980	1000	1465	2970	3500	1500	0.4	259	80

注：180K 至680K 最大限制电压测试电流是25A
The maximum limit voltage test current K 180K to 680 is 25A.

10D K 系列 电气参数 10D K Series Electrical Parameters

型号规格 Part NO.	Varistor Voltage		Maximum allowable voltage		Maximum Limited Voltage	Withstanding Surge current (1.2/50 μ s&8/20 μ s)		Rated Wattage	Energy (10/1000 μ s)	Typical Capacitance
	V1mA		AC	DC	V25A	I _{max}	I _n	(W)	(J)	1KHz
	(V)		(V)		(V)	(A)				(pF)
10D180K	18	16-20	11	14	38	500	—	0.05	2.8	6500
10D220K	22	20-24	14	18	43	500	—	0.05	3.5	5000
10D270K	27	24-30	17	22	53	500	—	0.05	4.2	4200
10D330K	33	30-36	20	26	65	500	—	0.05	5.2	3700
10D390K	39	35-43	25	31	77	500	—	0.05	6.2	3300
10D470K	47	42-52	30	38	93	500	—	0.05	7.4	2900
10D560K	56	50-62	35	45	110	500	—	0.05	8.8	2500
10D680K	68	61-75	40	56	135	500	—	0.05	11	2100
10D820K	82	74-90	50	65	135	2500	1500	0.4	13	1700
10D101K	100	90-100	60	85	165	2500	1500	0.4	16	1500
10D121K	120	108-132	75	100	200	2500	1500	0.4	19	1300
10D151K	150	135-165	95	125	250	2500	1500	0.4	24	1000
10D181K	180	162-198	115	150	300	2500	1500	0.4	28	770
10D201K	200	185-225	130	170	340	2500	1500	0.4	32	560
10D221K	220	198-242	140	180	360	2500	1500	0.4	35	440
10D241K	240	216-264	150	200	395	2500	1500	0.4	38	410
10D271K	270	243-297	175	225	455	2500	1500	0.4	43	380
10D301K	300	270-330	195	250	500	2500	1500	0.4	47	340
10D331K	330	297-363	215	275	550	2500	1500	0.4	52	330
10D361K	360	324-396	230	300	595	2500	1500	0.4	57	310
10D391K	390	351-429	250	320	650	2500	1500	0.4	61	290
10D431K	430	387-473	275	350	710	2500	1500	0.4	68	270
10D471K	470	423-517	300	385	775	2500	1500	0.4	74	240
10D511K	510	459-561	320	410	845	2500	1500	0.4	74	230
10D561K	560	504-616	350	455	930	2500	1500	0.4	74	230
10D621K	620	558-682	385	505	1025	2500	1500	0.4	74	190
10D681K	680	612-748	420	560	1120	2500	1500	0.4	74	170
10D751K	750	657-825	460	615	1240	2500	1500	0.4	75	160
10D781K	780	702-858	485	640	1290	2500	1500	0.4	78	160
10D821K	820	738-902	510	670	1355	2500	1500	0.4	85	160
10D911K	910	819-1001	550	745	1500	2500	1500	0.4	93	150
10D951K	950	855-1045	580	780	1570	2500	1500	0.4	97	130
10D102K	1000	900-1100	625	825	1650	2500	1500	0.4	102	120
10D112K	1100	990-1210	680	895	1815	2500	1500	0.4	115	110
10D152K	1500	1350-1650	900	1220	2475	2500	1500	0.4	155	100
10D182K	1800	1620-1980	1000	1465	2970	2500	1500	0.4	185	80

注: 180K 至680K 最大限制电压测试电流是25A
The maximum limit voltage test current K 180K to 680 is 25A.

10D KJ 系列 电气参数 10D KJ Series Electrical Parameters

型号规格 Part NO.	Varistor Voltage		Maximum allowable voltage		Maximum Limited Voltage	Withstanding Surge current (1.2/50 μ s&8/20 μ s)		Rated Wattage	Energy (10/1000 μ s)	Typical Capacitance
	V1mA		AC	DC	V25A	I _{max}	I _n	(W)	(J)	1KHz
	(V)		(V)		(V)	(A)				(pF)
10D180KJ	18	16-20	11	14	38	1000	500	0.05	3.9	6500
10D220KJ	22	20-24	14	18	43	1000	500	0.05	4.9	5000
10D270KJ	27	24-30	17	22	53	1000	500	0.05	5.9	4200
10D330KJ	33	30-36	20	26	65	1000	500	0.05	7.3	3700
10D390KJ	39	35-43	25	31	77	1000	500	0.05	8.7	3300
10D470KJ	47	42-52	30	38	93	1000	500	0.05	10	2900
10D560KJ	56	50-62	35	45	110	1000	500	0.05	12	2500
10D680KJ	68	61-75	40	56	135	1000	500	0.05	15	2100
10D820KJ	82	74-90	50	65	135	3500	1500	0.4	18	1700
10D101KJ	100	90-100	60	85	165	3500	1500	0.4	22	1500
10D121KJ	120	108-132	75	100	200	3500	1500	0.4	27	1300
10D151KJ	150	135-165	95	125	250	3500	1500	0.4	34	1000
10D181KJ	180	162-198	115	150	300	3500	1500	0.4	47	770
10D201KJ	200	185-225	130	170	340	3500	1500	0.4	52	560
10D221KJ	220	198-242	140	180	360	3500	1500	0.4	58	440
10D241KJ	240	216-264	150	200	395	3500	1500	0.4	64	410
10D271KJ	270	243-297	175	225	455	3500	1500	0.4	67	380
10D301KJ	300	270-330	195	250	500	3500	1500	0.4	70	340
10D331KJ	330	297-363	215	275	550	3500	1500	0.4	72	330
10D361KJ	360	324-396	230	300	595	3500	1500	0.4	76	310
10D391KJ	390	351-429	250	320	650	3500	1500	0.4	82	290
10D431KJ	430	387-473	275	350	710	3500	1500	0.4	93	270
10D471KJ	470	423-517	300	385	775	3500	1500	0.4	99	240
10D511KJ	510	459-561	320	410	845	3500	1500	0.4	107	230
10D561KJ	560	504-616	350	455	930	3500	1500	0.4	113	230
10D621KJ	620	558-682	385	505	1025	3500	1500	0.4	125	190
10D681KJ	680	612-748	420	560	1120	3500	1500	0.4	128	170
10D751KJ	750	657-825	460	615	1240	3500	1500	0.4	134	160
10D781KJ	780	702-858	485	640	1290	3500	1500	0.4	139	160
10D821KJ	820	738-902	510	670	1355	3500	1500	0.4	146	160
10D911KJ	910	819-1001	550	745	1500	3500	1500	0.4	152	150
10D951KJ	950	855-1045	580	780	1570	3500	1500	0.4	158	130
10D102KJ	1000	900-1100	625	825	1650	3500	1500	0.4	170	120
10D112KJ	1100	990-1210	680	895	1815	3500	1500	0.4	180	110
10D152KJ	1500	1350-1650	900	1220	2475	3500	1500	0.4	217	100
10D182KJ	1800	1620-1980	1000	1465	2970	3500	1500	0.4	259	80

注: 180K 至680K 最大限制电压测试电流是25A
The maximum limit voltage test current K 180K to 680 is 25A.

10D KH 系列 电气参数 10D KH Series Electrical Parameters

型号规格 Part NO.	Varistor Voltage		Maximum allowable voltage		Maximum Limited Voltage	Withstanding Surge current (1.2/50 μ s&8/20 μ s)		Rated Wattage (W)	Energy (10/1000 μ s) (J)	Typical Capacitance 1KHz (pF)
	V1mA	AC	DC	V25A	I _{max}	I _n				
	(V)	(V)		(V)	(A)					
10D431KH	430	387-473	275	350	710	3500	4KV/2KA	0.4	93	270
10D471KH	470	423-517	300	385	775	3500	4KV/2KA	0.4	99	240
10D551KH	510	459-561	320	410	842	3500	4KV/2KA	0.4	107	230
10D561KH	560	504-616	350	460	920	3500	4KV/2KA	0.4	113	230
10D621KH	620	558-682	385	505	1025	3500	4KV/2KA	0.4	125	190
10D681KH	680	612-748	420	560	1120	3500	4KV/2KA	0.4	128	170
10D751KH	750	657-825	460	615	1240	3500	4KV/2KA	0.4	134	160
10D781KH	780	702-858	485	640	1290	3500	4KV/2KA	0.4	139	160
10D821KH	820	738-902	510	670	1355	3500	4KV/2KA	0.4	146	160
10D911KH	910	819-1001	550	745	1500	3500	4KV/2KA	0.4	152	150
10D951KH	950	855-1045	580	780	1570	3500	4KV/2KA	0.4	158	130
10D102KH	1000	900-1100	625	825	1650	3500	4KV/2KA	0.4	170	120
10D112KH	1100	990-1210	680	895	1815	3500	4KV/2KA	0.4	180	110
10D152KH	1500	1350-1650	900	1220	2475	3500	4KV/2KA	0.4	217	100
10D182KH	1800	1620-1980	1000	1465	2970	3500	4KV/2KA	0.4	259	80

产品尺寸 单位 (Unit) :mm

产品外形 Product shape	系列 Series	压敏电压 Varistor voltage	厚度 T max
	10D	18V-39V	4.5
		47V-68V	5.0
		82V-150V	4.5
		180V-270V	5.0
		330V-390V	5.5
		430V-560V	6.0
		620V-750V	7.0
		820V-1200V	8.2
		1300V-1500V	9.3
		1600V-1800V	11.0

14D K 系列 电气参数 14D K Series Electrical Parameters

型号规格 Part NO.	Varistor Voltage		Maximum allowable voltage		Maximum Limited Voltage	Withstanding Surge current (1.2/50 μ s&8/20 μ s)		Rated Wattage (W)	Energy (10/1000 μ s) (J)	Typical Capacitance 1KHz (pF)
	V1mA	AC	DC	V50A	I _{max}	I _n				
	(V)	(V)		(V)	(A)					
14D180K	18	16-20	11	14	38	1000	—	0.1	5.7	18000
14D220K	22	20-24	14	18	43	1000	—	0.1	7	15000
14D270K	27	24-30	17	22	53	1000	—	0.1	8.5	10000
14D330K	33	30-36	20	26	65	1000	—	0.1	10	8500
14D390K	39	35-43	25	31	77	1000	—	0.1	12	7500
14D470K	47	42-52	30	38	93	1000	—	0.1	15	6500
14D560K	56	50-62	35	45	110	1000	—	0.1	18	5600
14D680K	68	61-75	40	56	135	1000	—	0.1	21	4700
14D820K	82	74-90	50	65	135	4500	3000	0.6	26	3900
14D101K	100	90-100	60	85	165	4500	3000	0.6	32	3400
14D121K	120	108-132	75	100	200	4500	3000	0.6	38	3100
14D151K	150	135-165	95	125	250	4500	3000	0.6	47	3000
14D181K	180	162-198	115	150	300	4500	3000	0.6	57	1030
14D201K	200	185-225	130	170	340	4500	3000	0.6	63	970
14D221K	220	198-242	140	180	360	4500	3000	0.6	69	840
14D241K	240	216-264	150	200	395	4500	3000	0.6	76	710
14D271K	270	243-297	175	225	455	4500	3000	0.6	85	650
14D301K	300	270-330	195	250	500	4500	3000	0.6	95	600
14D331K	330	297-363	215	275	550	4500	3000	0.6	104	550
14D361K	360	324-396	230	300	595	4500	3000	0.6	113	500
14D391K	390	351-429	250	320	650	4500	3000	0.6	123	480
14D431K	430	387-473	275	350	710	4500	3000	0.6	136	440
14D471K	470	423-517	300	385	775	4500	3000	0.6	148	420
14D511K	510	459-561	320	410	845	4500	3000	0.6	148	390
14D561K	560	504-616	350	455	930	4500	3000	0.6	148	360
14D621K	620	558-682	385	505	1025	4500	3000	0.6	148	320
14D681K	680	612-748	420	560	1120	4500	3000	0.6	148	290
14D751K	750	657-825	460	615	1240	4500	3000	0.6	158	260
14D781K	780	702-858	485	640	1290	4500	3000	0.6	164	230
14D821K	820	738-902	510	670	1355	4500	3000	0.6	172	230
14D911K	910	819-1001	550	745	1500	4500	3000	0.6	191	200
14D951K	950	855-1045	575	765	1580	4500	3000	0.6	199	190
14D102K	1.0K	900-1100	625	825	1650	4500	3000	0.6	210	180
14D112K	1.1K	990-1210	680	895	1815	4500	3000	0.6	231	150
14D152K	1.5	1350-1650	900	1220	2475	4500	3000	0.6	312	140
14D182K	1.8K	1620-1980	1000	1465	2970	4500	3000	0.6	378	120

注: 180K 至680K 最大限制电压测试电流是50A

The maximum limit voltage test current K 180K to 680 is 50A.

10D KH 系列 电气参数 10D KH Series Electrical Parameters

型号规格 Part NO.	Varistor Voltage		Maximum allowable voltage		Maximum Limited Voltage	Withstanding Surge current (1.2/50 μ s&8/20 μ s)		Rated Wattage (W)	Energy (10/1000 μ s) (J)	Typical Capacitance 1KHz (pF)
	V1mA	AC	DC	V25A	I _{max}	I _n				
	(V)	(V)		(V)	(A)					
10D431KH	430	387-473	275	350	710	3500	4KV/2KA	0.4	93	270
10D471KH	470	423-517	300	385	775	3500	4KV/2KA	0.4	99	240
10D551KH	510	459-561	320	410	842	3500	4KV/2KA	0.4	107	230
10D561KH	560	504-616	350	460	920	3500	4KV/2KA	0.4	113	230
10D621KH	620	558-682	385	505	1025	3500	4KV/2KA	0.4	125	190
10D681KH	680	612-748	420	560	1120	3500	4KV/2KA	0.4	128	170
10D751KH	750	657-825	460	615	1240	3500	4KV/2KA	0.4	134	160
10D781KH	780	702-858	485	640	1290	3500	4KV/2KA	0.4	139	160
10D821KH	820	738-902	510	670	1355	3500	4KV/2KA	0.4	146	160
10D911KH	910	819-1001	550	745	1500	3500	4KV/2KA	0.4	152	150
10D951KH	950	855-1045	580	780	1570	3500	4KV/2KA	0.4	158	130
10D102KH	1000	900-1100	625	825	1650	3500	4KV/2KA	0.4	170	120
10D112KH	1100	990-1210	680	895	1815	3500	4KV/2KA	0.4	180	110
10D152KH	1500	1350-1650	900	1220	2475	3500	4KV/2KA	0.4	217	100
10D182KH	1800	1620-1980	1000	1465	2970	3500	4KV/2KA	0.4	259	80

产品尺寸 单位 (Unit) :mm

产品外形 Product shape	系列 Series	压敏电压 Varistor voltage	厚度 T max
	10D	18V-39V	4.5
		47V-68V	5.0
		82V-150V	4.5
		180V-270V	5.0
		330V-390V	5.5
		430V-560V	6.0
		620V-750V	7.0
		820V-1200V	8.2
		1300V-1500V	9.3
		1600V-1800V	11.0

14D K 系列 电气参数 14D K Series Electrical Parameters

型号规格 Part NO.	Varistor Voltage		Maximum allowable voltage		Maximum Limited Voltage	Withstanding Surge current (1.2/50 μ s&8/20 μ s)		Rated Wattage (W)	Energy (10/1000 μ s) (J)	Typical Capacitance 1KHz (pF)
	V1mA	AC	DC	V50A	I _{max}	I _n				
	(V)	(V)		(V)	(A)					
14D180K	18	16-20	11	14	38	1000	—	0.1	5.7	18000
14D220K	22	20-24	14	18	43	1000	—	0.1	7	15000
14D270K	27	24-30	17	22	53	1000	—	0.1	8.5	10000
14D330K	33	30-36	20	26	65	1000	—	0.1	10	8500
14D390K	39	35-43	25	31	77	1000	—	0.1	12	7500
14D470K	47	42-52	30	38	93	1000	—	0.1	15	6500
14D560K	56	50-62	35	45	110	1000	—	0.1	18	5600
14D680K	68	61-75	40	56	135	1000	—	0.1	21	4700
14D820K	82	74-90	50	65	135	4500	3000	0.6	26	3900
14D101K	100	90-100	60	85	165	4500	3000	0.6	32	3400
14D121K	120	108-132	75	100	200	4500	3000	0.6	38	3100
14D151K	150	135-165	95	125	250	4500	3000	0.6	47	3000
14D181K	180	162-198	115	150	300	4500	3000	0.6	57	1030
14D201K	200	185-225	130	170	340	4500	3000	0.6	63	970
14D221K	220	198-242	140	180	360	4500	3000	0.6	69	840
14D241K	240	216-264	150	200	395	4500	3000	0.6	76	710
14D271K	270	243-297	175	225	455	4500	3000	0.6	85	650
14D301K	300	270-330	195	250	500	4500	3000	0.6	95	600
14D331K	330	297-363	215	275	550	4500	3000	0.6	104	550
14D361K	360	324-396	230	300	595	4500	3000	0.6	113	500
14D391K	390	351-429	250	320	650	4500	3000	0.6	123	480
14D431K	430	387-473	275	350	710	4500	3000	0.6	136	440
14D471K	470	423-517	300	385	775	4500	3000	0.6	148	420
14D511K	510	459-561	320	410	845	4500	3000	0.6	148	390
14D561K	560	504-616	350	455	930	4500	3000	0.6	148	360
14D621K	620	558-682	385	505	1025	4500	3000	0.6	148	320
14D681K	680	612-748	420	560	1120	4500	3000	0.6	148	290
14D751K	750	657-825	460	615	1240	4500	3000	0.6	158	260
14D781K	780	702-858	485	640	1290	4500	3000	0.6	164	230
14D821K	820	738-902	510	670	1355	4500	3000	0.6	172	230
14D911K	910	819-1001	550	745	1500	4500	3000	0.6	191	200
14D951K	950	855-1045	575	765	1580	4500	3000	0.6	199	190
14D102K	1.0K	900-1100	625	825	1650	4500	3000	0.6	210	180
14D112K	1.1K	990-1210	680	895	1815	4500	3000	0.6	231	150
14D152K	1.5	1350-1650	900	1220	2475	4500	3000	0.6	312	140
14D182K	1.8K	1620-1980	1000	1465	2970	4500	3000	0.6	378	120

注: 180K 至680K 最大限制电压测试电流是50A

The maximum limit voltage test current K 180K to 680 is 50A.

14D KJ 系列 电气参数 14D KJ Series Electrical Parameters

型号规格 Part NO.	Varistor Voltage		Maximum allowable voltage		Maximum Limited Voltage	Withstanding Surge current (1.2/50 μs & 8/20 μs)		Rated Wattage	Energy (10/1000 μs)	Typical Capacitance
	V1mA		AC	DC	V50A	I _{max}	I _n	(W)	(J)	1kHz
	(V)		(V)		(V)	(A)				(pF)
14D180KJ	18	16-20	11	14	38	2000	1000	0.1	6.8	18000
14D220KJ	22	20-24	14	18	43	2000	1000	0.1	8.4	15000
14D270KJ	27	24-30	17	22	53	2000	1000	0.1	10	10000
14D330KJ	33	30-36	20	26	65	2000	1000	0.1	12	8500
14D390KJ	39	35-43	25	31	77	2000	1000	0.1	14	7500
14D470KJ	47	42-52	30	38	93	2000	1000	0.1	18	6500
14D560KJ	56	50-62	35	45	110	2000	1000	0.1	22	5600
14D680KJ	68	61-75	40	56	135	2000	1000	0.1	25	4700
14D820KJ	82	74-90	50	65	135	6000	3000	0.6	31	3900
14D101KJ	100	90-100	60	85	165	6000	3000	0.6	38	3400
14D121KJ	120	108-132	75	100	200	6000	3000	0.6	46	3100
14D151KJ	150	135-165	95	125	250	6000	3000	0.6	56	3000
14D181KJ	180	162-198	115	150	300	6000	3000	0.6	60	1030
14D201KJ	200	185-225	130	170	340	6000	3000	0.6	82	970
14D221KJ	220	198-242	140	180	360	6000	3000	0.6	90	840
14D241KJ	240	216-264	150	200	395	6000	3000	0.6	98	710
14D271KJ	270	243-297	175	225	455	6000	3000	0.6	116	650
14D301KJ	300	270-330	195	250	500	6000	3000	0.6	128	600
14D331KJ	330	297-363	215	275	550	6000	3000	0.6	140	550
14D361KJ	360	324-396	230	300	595	6000	3000	0.6	158	500
14D391KJ	390	351-429	250	320	650	6000	3000	0.6	170	480
14D431KJ	430	387-473	275	350	710	6000	3000	0.6	185	440
14D471KJ	470	423-517	300	385	775	6000	3000	0.6	205	420
14D511KJ	510	459-561	320	410	845	6000	3000	0.6	220	390
14D561KJ	560	504-616	350	455	930	6000	3000	0.6	240	360
14D621KJ	620	558-682	385	505	1025	6000	3000	0.6	250	320
14D681KJ	680	612-748	420	560	1120	6000	3000	0.6	260	290
14D751KJ	750	657-825	460	615	1240	6000	3000	0.6	270	260
14D781KJ	780	702-858	485	640	1290	6000	3000	0.6	275	230
14D821KJ	820	738-902	510	670	1355	6000	3000	0.6	280	230
14D911KJ	910	819-1001	550	745	1500	6000	3000	0.6	295	200
14D951KJ	951	855-1045	575	765	1580	6000	3000	0.6	305	190
14D102KJ	1.0K	900-1100	625	825	1650	6000	3000	0.6	335	180
14D112KJ	1.1K	990-1210	680	895	1815	6000	3000	0.6	360	150
14D152KJ	1.5	1350-1650	900	1220	2475	6000	3000	0.6	375	140
14D182KJ	1.8K	1620-1980	1000	1465	2970	6000	3000	0.6	450	120

注：180K 至680K 最大限制电压测试电流是50A
The maximum limit voltage test current K 180K to 680 is 50A.

14D KH 系列 电气参数 14D KH Series Electrical Parameters

型号规格 Part NO.	Varistor Voltage		Maximum allowable voltage		Maximum Limited Voltage	Withstanding Surge current (1.2/50 μs & 8/20 μs)		Rated Wattage	Energy (10/1000 μs)	Typical Capacitance
	V1mA		AC	DC	V50A	I _{max}	I _n	(W)	(J)	1kHz
	(V)		(V)		(V)	(A)				(pF)
14D431KH	430	387-473	275	350	710	6000	6KV/3KA	0.6	185	440
14D471KH	470	423-517	300	385	775	6000	6KV/3KA	0.6	205	420
14D511KH	510	459-561	320	410	845	6000	6KV/3KA	0.6	220	390
14D561KH	560	504-616	350	455	930	6000	6KV/3KA	0.6	240	360
14D621KH	620	558-682	385	505	1025	6000	6KV/3KA	0.6	250	320
14D681KH	680	612-748	420	560	1120	6000	6KV/3KA	0.6	260	290
14D751KH	750	657-825	460	615	1240	6000	6KV/3KA	0.6	270	260
14D781KH	780	702-858	485	640	1290	6000	6KV/3KA	0.6	275	230
14D821KH	820	738-902	510	670	1355	6000	6KV/3KA	0.6	280	230
14D911KH	910	819-1001	550	745	1500	6000	6KV/3KA	0.6	295	200
14D951KH	951	855-1045	575	765	1580	6000	6KV/3KA	0.6	305	190
14D102KH	1.0K	900-1100	625	825	1650	6000	6KV/3KA	0.6	335	180
14D112KH	1.1K	990-1210	680	895	1815	6000	6KV/3KA	0.6	360	150
14D152KH	1.5	1350-1650	900	1220	2475	6000	6KV/3KA	0.6	375	140
14D182KH	1.8K	1620-1980	1000	1465	2970	6000	6KV/3KA	0.6	450	120

产品尺寸 单位 (Unit) :mm

产品外形 Product shape	系列 Series	压敏电压 Varistor voltage	厚度 T max
	14D	18V-39V	4.6
		47V-68V	5.1
		82V-150V	4.6
		180V-270V	5.1
		330V-390V	5.6
		430V-560V	6.2
		620V-780V	7.2
		820V-1200V	8.4
		1300V-1500V	9.5
		1600V-1800V	11.3

MOV

14D KJ 系列 电气参数 14D KJ Series Electrical Parameters

型号规格 Part NO.	Varistor Voltage		Maximum allowable voltage		Maximum Limited Voltage	Withstanding Surge current (1.2/50 μs & 8/20 μs)		Rated Wattage	Energy (10/1000 μs)	Typical Capacitance
	V1mA		AC	DC	V50k	I _{max}	I _n	(W)	(J)	1kHz
	(V)		(V)		(V)	(A)				(pF)
14D180KJ	18	16-20	11	14	38	2000	1000	0.1	6.8	18000
14D220KJ	22	20-24	14	18	43	2000	1000	0.1	8.4	15000
14D270KJ	27	24-30	17	22	53	2000	1000	0.1	10	10000
14D330KJ	33	30-36	20	26	65	2000	1000	0.1	12	8500
14D390KJ	39	35-43	25	31	77	2000	1000	0.1	14	7500
14D470KJ	47	42-52	30	38	93	2000	1000	0.1	18	6500
14D560KJ	56	50-62	35	45	110	2000	1000	0.1	22	5600
14D680KJ	68	61-75	40	56	135	2000	1000	0.1	25	4700
14D820KJ	82	74-90	50	65	135	6000	3000	0.6	31	3900
14D101KJ	100	90-100	60	85	165	6000	3000	0.6	38	3400
14D121KJ	120	108-132	75	100	200	6000	3000	0.6	46	3100
14D151KJ	150	135-165	95	125	250	6000	3000	0.6	56	3000
14D181KJ	180	162-198	115	150	300	6000	3000	0.6	60	1030
14D201KJ	200	185-225	130	170	340	6000	3000	0.6	82	970
14D221KJ	220	198-242	140	180	360	6000	3000	0.6	90	840
14D241KJ	240	216-264	150	200	395	6000	3000	0.6	98	710
14D271KJ	270	243-297	175	225	455	6000	3000	0.6	116	650
14D301KJ	300	270-330	195	250	500	6000	3000	0.6	128	600
14D331KJ	330	297-363	215	275	550	6000	3000	0.6	140	550
14D361KJ	360	324-396	230	300	595	6000	3000	0.6	158	500
14D391KJ	390	351-429	250	320	650	6000	3000	0.6	170	480
14D431KJ	430	387-473	275	350	710	6000	3000	0.6	185	440
14D471KJ	470	423-517	300	385	775	6000	3000	0.6	205	420
14D511KJ	510	459-561	320	410	845	6000	3000	0.6	220	390
14D561KJ	560	504-616	350	455	930	6000	3000	0.6	240	360
14D621KJ	620	558-682	385	505	1025	6000	3000	0.6	250	320
14D681KJ	680	612-748	420	560	1120	6000	3000	0.6	260	290
14D751KJ	750	657-825	460	615	1240	6000	3000	0.6	270	260
14D781KJ	780	702-858	485	640	1290	6000	3000	0.6	275	230
14D821KJ	820	738-902	510	670	1355	6000	3000	0.6	280	230
14D911KJ	910	819-1001	550	745	1500	6000	3000	0.6	295	200
14D951KJ	951	855-1045	575	765	1580	6000	3000	0.6	305	190
14D102KJ	1.0K	900-1100	625	825	1650	6000	3000	0.6	335	180
14D112KJ	1.1K	990-1210	680	895	1815	6000	3000	0.6	360	150
14D152KJ	1.5	1350-1650	900	1220	2475	6000	3000	0.6	375	140
14D182KJ	1.8K	1620-1980	1000	1465	2970	6000	3000	0.6	450	120

注：180K 至680K 最大限制电压测试电流是50A
The maximum limit voltage test current K 180K to 680 is 50A.

14D KH 系列 电气参数 14D KH Series Electrical Parameters

型号规格 Part NO.	Varistor Voltage		Maximum allowable voltage		Maximum Limited Voltage	Withstanding Surge current (1.2/50 μs & 8/20 μs)		Rated Wattage	Energy (10/1000 μs)	Typical Capacitance
	V1mA		AC	DC	V50k	I _{max}	I _n	(W)	(J)	1kHz
	(V)		(V)		(V)	(A)				(pF)
14D431KH	430	387-473	275	350	710	6000	6KV/3KA	0.6	185	440
14D471KH	470	423-517	300	385	775	6000	6KV/3KA	0.6	205	420
14D511KH	510	459-561	320	410	845	6000	6KV/3KA	0.6	220	390
14D561KH	560	504-616	350	455	930	6000	6KV/3KA	0.6	240	360
14D621KH	620	558-682	385	505	1025	6000	6KV/3KA	0.6	250	320
14D681KH	680	612-748	420	560	1120	6000	6KV/3KA	0.6	260	290
14D751KH	750	657-825	460	615	1240	6000	6KV/3KA	0.6	270	260
14D781KH	780	702-858	485	640	1290	6000	6KV/3KA	0.6	275	230
14D821KH	820	738-902	510	670	1355	6000	6KV/3KA	0.6	280	230
14D911KH	910	819-1001	550	745	1500	6000	6KV/3KA	0.6	295	200
14D951KH	951	855-1045	575	765	1580	6000	6KV/3KA	0.6	305	190
14D102KH	1.0K	900-1100	625	825	1650	6000	6KV/3KA	0.6	335	180
14D112KH	1.1K	990-1210	680	895	1815	6000	6KV/3KA	0.6	360	150
14D152KH	1.5	1350-1650	900	1220	2475	6000	6KV/3KA	0.6	375	140
14D182KH	1.8K	1620-1980	1000	1465	2970	6000	6KV/3KA	0.6	450	120

产品尺寸 单位 (Unit) :mm

产品外形 Product shape	系列 Series	压敏电压 Varistor voltage	厚度 T max
	14D	18V-39V	4.6
		47V-68V	5.1
		82V-150V	4.6
		180V-270V	5.1
		330V-390V	5.6
		430V-560V	6.2
		620V-780V	7.2
		820V-1200V	8.4
		1300V-1500V	9.5
		1600V-1800V	11.3

MOV

20D K 系列 电气参数 20D K Series Electrical Parameters

型号规格 Part NO.	Varistor Voltage		Maximum allowable voltage		Maximum Limited Voltage	Withstanding Surge current (1.2/50 μ s&8/20 μ s)		Rated Wattage	Energy (10/1000 μ s)	Typical Capacitance
	V1mA	AC	DC	V100A	I _{max}	I _n	(W)	(J)	1KHz	
	(V)	(V)		(V)	(A)				(pF)	
20D180K	18	16-20	11	14	0.38	2000	—	0.2	11	39000
20D220K	22	20-24	14	18	0.43	2000	—	0.2	14	32000
20D270K	27	24-30	17	22	0.53	2000	—	0.2	18	22000
20D330K	33	30-36	20	26	0.65	2000	—	0.2	23	18000
20D390K	39	35-43	25	31	0.77	2000	—	0.2	26	16000
20D470K	47	42-52	30	38	0.93	2000	—	0.2	33	14000
20D560K	56	50-62	35	45	0.11	2000	—	0.2	41	12000
20D680K	68	61-75	40	56	0.135	2000	—	0.2	46	10000
20D820K	82	74-90	50	65	135	6500	3000	1	48	5800
20D101K	100	90-100	60	85	165	6500	3000	1	52	4800
20D121K	120	108-132	75	100	200	6500	3000	1	56	3800
20D151K	150	135-165	95	125	250	6500	3000	1	71	3000
20D181K	180	162-198	115	150	300	6500	3000	1	86	2600
20D201K	200	180-220	130	170	340	6500	3000	1	97	2400
20D221K	220	198-242	140	180	360	6500	3000	1	102	2100
20D241K	240	216-264	150	200	395	6500	3000	1	110	1950
20D271K	270	243-297	175	225	455	6500	3000	1	130	1700
20D301K	300	270-330	195	250	505	6500	3000	1	139	1600
20D331K	330	297-363	210	275	550	6500	3000	1	153	1400
20D361K	360	324-396	230	300	595	6500	3000	1	166	1300
20D391K	390	351-429	250	320	650	6500	3000	1	184	1180
20D431K	430	387-473	275	350	710	6500	3000	1	194	1100
20D471K	470	423-517	300	385	775	6500	3000	1	224	1050
20D511K	510	459-561	320	418	842	6500	3000	1	224	1000
20D561K	560	504-616	350	460	920	6500	3000	1	224	970
20D621K	620	558-682	385	505	1025	6500	3000	1	224	950
20D681K	680	612-748	420	560	1120	6500	3000	1	235	900
20D751K	750	675-825	460	615	1240	6500	3000	1	260	850
20D781K	780	702-858	485	640	1290	6500	3000	1	269	750
20D821K	820	738-902	510	670	1355	6500	3000	1	288	700
20D911K	910	919-1001	550	745	1500	6500	3000	1	316	600
20D951K	950	855-1045	580	780	1570	6500	3000	1	328	580
20D102K	1000	900-1100	625	825	1650	6500	3000	1	349	500
20D112K	1100	990-1210	680	895	1815	6500	3000	1	391	450
20D152K	1500	1350-1650	900	1220	2475	6500	3000	1	516	400
20D182K	1800	1620-1980	1000	1465	2970	6500	3000	1	632	220

注: 180K 至680K 最大限制电压测试电流是100A

The maximum limit voltage test current K 180K to 680 is 100A.

20D KJ 系列 电气参数 20D KJ Series Electrical Parameters

型号规格 Part NO.	Varistor Voltage		Maximum allowable voltage		Maximum Limited Voltage	Withstanding Surge current (1.2/50 μ s&8/20 μ s)		Rated Wattage	Energy (10/1000 μ s)	Typical Capacitance
	V1mA	AC	DC	V100A	I _{max}	I _n	(W)	(J)	1KHz	
	(V)	(V)		(V)	(A)				(pF)	
20D180KJ	18	16-20	11	14	0.38	3000	1000	0.2	13	39000
20D220KJ	22	20-24	14	18	0.43	3000	1000	0.2	17	32000
20D270KJ	27	24-30	17	22	0.53	3000	1000	0.2	22	22000
20D330KJ	33	30-36	20	26	0.65	3000	1000	0.2	28	18000
20D390KJ	39	35-43	25	31	0.77	3000	1000	0.2	31	16000
20D470KJ	47	42-52	30	38	0.93	3000	1000	0.2	40	14000
20D560KJ	56	50-62	35	45	0.11	3000	1000	0.2	49	12000
20D680KJ	68	61-75	40	56	0.135	3000	1000	0.2	55	10000
20D820KJ	82	74-90	50	65	135	10000	5000	1	67	5800
20D101KJ	100	90-100	60	85	165	10000	5000	1	73	4800
20D121KJ	120	108-132	75	100	200	10000	5000	1	78	3800
20D151KJ	150	135-165	95	125	250	10000	5000	1	99	3000
20D181KJ	180	162-198	115	150	300	10000	5000	1	152	2600
20D201KJ	200	180-220	130	170	340	10000	5000	1	175	2400
20D221KJ	220	198-242	140	180	360	10000	5000	1	185	2100
20D241KJ	240	216-264	150	200	395	10000	5000	1	198	1950
20D271KJ	270	243-297	175	225	455	10000	5000	1	220	1700
20D301KJ	300	270-330	195	250	505	10000	5000	1	245	1600
20D331KJ	330	297-363	210	275	550	10000	5000	1	268	1400
20D361KJ	360	324-396	230	300	595	10000	5000	1	315	1300
20D391KJ	390	351-429	250	320	650	10000	5000	1	350	1180
20D431KJ	430	387-473	275	350	710	10000	5000	1	380	1100
20D471KJ	470	423-517	300	385	775	10000	5000	1	405	1050
20D511KJ	510	459-561	320	418	842	10000	5000	1	445	1000
20D561KJ	560	504-616	350	460	920	10000	5000	1	475	970
20D621KJ	620	558-682	385	505	1025	10000	5000	1	490	950
20D681KJ	680	612-748	420	560	1120	10000	5000	1	500	900
20D751KJ	750	675-825	460	615	1240	10000	5000	1	525	850
20D781KJ	780	702-858	485	640	1290	10000	5000	1	530	750
20D821KJ	820	738-902	510	670	1355	10000	5000	1	545	700
20D911KJ	910	919-1001	550	745	1500	10000	5000	1	595	600
20D951KJ	950	855-1045	580	780	1570	10000	5000	1	610	580
20D102KJ	1000	900-1100	625	825	1650	10000	5000	1	650	500
20D112KJ	1100	990-1210	680	895	1815	10000	5000	1	720	450
20D152KJ	1500	1350-1650	900	1220	2475	10000	5000	1	790	400
20D182KJ	1800	1620-1980	1000	1465	2970	10000	5000	1	850	220

注: 180K 至680K 最大限制电压测试电流是100A

The maximum limit voltage test current K 180K to 680 is 100A.

20D K 系列 电气参数 20D K Series Electrical Parameters

型号规格 Part NO.	Varistor Voltage		Maximum allowable voltage		Maximum Limited Voltage	Withstanding Surge current (1.2/50 μ s&8/20 μ s)		Rated Wattage	Energy (10/1000 μ s)	Typical Capacitance
	V1mA		AC	DC	V100A	I _{max}	I _n	(W)	(J)	1KHz
	(V)		(V)		(V)	(A)				(pF)
20D180K	18	16-20	11	14	0.38	2000	—	0.2	11	39000
20D220K	22	20-24	14	18	0.43	2000	—	0.2	14	32000
20D270K	27	24-30	17	22	0.53	2000	—	0.2	18	22000
20D330K	33	30-36	20	26	0.65	2000	—	0.2	23	18000
20D390K	39	35-43	25	31	0.77	2000	—	0.2	26	16000
20D470K	47	42-52	30	38	0.93	2000	—	0.2	33	14000
20D560K	56	50-62	35	45	0.11	2000	—	0.2	41	12000
20D680K	68	61-75	40	56	0.135	2000	—	0.2	46	10000
20D820K	82	74-90	50	65	135	6500	3000	1	48	5800
20D101K	100	90-100	60	85	165	6500	3000	1	52	4800
20D121K	120	108-132	75	100	200	6500	3000	1	56	3800
20D151K	150	135-165	95	125	250	6500	3000	1	71	3000
20D181K	180	162-198	115	150	300	6500	3000	1	86	2600
20D201K	200	180-220	130	170	340	6500	3000	1	97	2400
20D221K	220	198-242	140	180	360	6500	3000	1	102	2100
20D241K	240	216-264	150	200	395	6500	3000	1	110	1950
20D271K	270	243-297	175	225	455	6500	3000	1	130	1700
20D301K	300	270-330	195	250	505	6500	3000	1	139	1600
20D331K	330	297-363	210	275	550	6500	3000	1	153	1400
20D361K	360	324-396	230	300	595	6500	3000	1	166	1300
20D391K	390	351-429	250	320	650	6500	3000	1	184	1180
20D431K	430	387-473	275	350	710	6500	3000	1	194	1100
20D471K	470	423-517	300	385	775	6500	3000	1	224	1050
20D511K	510	459-561	320	418	842	6500	3000	1	224	1000
20D561K	560	504-616	350	460	920	6500	3000	1	224	970
20D621K	620	558-682	385	505	1025	6500	3000	1	224	950
20D681K	680	612-748	420	560	1120	6500	3000	1	235	900
20D751K	750	675-825	460	615	1240	6500	3000	1	260	850
20D781K	780	702-858	485	640	1290	6500	3000	1	269	750
20D821K	820	738-902	510	670	1355	6500	3000	1	288	700
20D911K	910	919-1001	550	745	1500	6500	3000	1	316	600
20D951K	950	855-1045	580	780	1570	6500	3000	1	328	580
20D102K	1000	900-1100	625	825	1650	6500	3000	1	349	500
20D112K	1100	990-1210	680	895	1815	6500	3000	1	391	450
20D152K	1500	1350-1650	900	1220	2475	6500	3000	1	516	400
20D182K	1800	1620-1980	1000	1465	2970	6500	3000	1	632	220

注：180K 至680K 最大限制电压测试电流是100A

The maximum limit voltage test current K 180K to 680 is 100A.

20D KJ 系列 电气参数 20D KJ Series Electrical Parameters

型号规格 Part NO.	Varistor Voltage		Maximum allowable voltage		Maximum Limited Voltage	Withstanding Surge current (1.2/50 μ s&8/20 μ s)		Rated Wattage	Energy (10/1000 μ s)	Typical Capacitance
	V1mA		AC	DC	V100A	I _{max}	I _n	(W)	(J)	1KHz
	(V)		(V)		(V)	(A)				(pF)
20D180KJ	18	16-20	11	14	0.38	3000	1000	0.2	13	39000
20D220KJ	22	20-24	14	18	0.43	3000	1000	0.2	17	32000
20D270KJ	27	24-30	17	22	0.53	3000	1000	0.2	22	22000
20D330KJ	33	30-36	20	26	0.65	3000	1000	0.2	28	18000
20D390KJ	39	35-43	25	31	0.77	3000	1000	0.2	31	16000
20D470KJ	47	42-52	30	38	0.93	3000	1000	0.2	40	14000
20D560KJ	56	50-62	35	45	0.11	3000	1000	0.2	49	12000
20D680KJ	68	61-75	40	56	0.135	3000	1000	0.2	55	10000
20D820KJ	82	74-90	50	65	135	10000	5000	1	67	5800
20D101KJ	100	90-100	60	85	165	10000	5000	1	73	4800
20D121KJ	120	108-132	75	100	200	10000	5000	1	78	3800
20D151KJ	150	135-165	95	125	250	10000	5000	1	99	3000
20D181KJ	180	162-198	115	150	300	10000	5000	1	152	2600
20D201KJ	200	180-220	130	170	340	10000	5000	1	175	2400
20D221KJ	220	198-242	140	180	360	10000	5000	1	185	2100
20D241KJ	240	216-264	150	200	395	10000	5000	1	198	1950
20D271KJ	270	243-297	175	225	455	10000	5000	1	220	1700
20D301KJ	300	270-330	195	250	505	10000	5000	1	245	1600
20D331KJ	330	297-363	210	275	550	10000	5000	1	268	1400
20D361KJ	360	324-396	230	300	595	10000	5000	1	315	1300
20D391KJ	390	351-429	250	320	650	10000	5000	1	350	1180
20D431KJ	430	387-473	275	350	710	10000	5000	1	380	1100
20D471KJ	470	423-517	300	385	775	10000	5000	1	405	1050
20D511KJ	510	459-561	320	418	842	10000	5000	1	445	1000
20D561KJ	560	504-616	350	460	920	10000	5000	1	475	970
20D621KJ	620	558-682	385	505	1025	10000	5000	1	490	950
20D681KJ	680	612-748	420	560	1120	10000	5000	1	500	900
20D751KJ	750	675-825	460	615	1240	10000	5000	1	525	850
20D781KJ	780	702-858	485	640	1290	10000	5000	1	530	750
20D821KJ	820	738-902	510	670	1355	10000	5000	1	545	700
20D911KJ	910	919-1001	550	745	1500	10000	5000	1	595	600
20D951KJ	950	855-1045	580	780	1570	10000	5000	1	610	580
20D102KJ	1000	900-1100	625	825	1650	10000	5000	1	650	500
20D112KJ	1100	990-1210	680	895	1815	10000	5000	1	720	450
20D152KJ	1500	1350-1650	900	1220	2475	10000	5000	1	790	400
20D182KJ	1800	1620-1980	1000	1465	2970	10000	5000	1	850	220

注：180K 至680K 最大限制电压测试电流是100A

The maximum limit voltage test current K 180K to 680 is 100A.

20D KH 系列 电气参数 20D KH Series Electrical Parameters

型号规格 Part NO.	Varistor Voltage		Maximum allowable voltage		Maximum Limited Voltage	Withstanding Surge current (1.2/50 μs & 8/20 μs)		Rated Wattage (W)	Energy (10/1000 μs) (J)	Typical Capacitance
	V1mA		AC	DC	V100A	I _{max}	I _n			1KHz
	(V)		(V)		(V)	(A)				(pF)
20D431KH	430	387-473	275	350	710	10000	10KV/5KA	1	380	1100
20D471KH	470	423-517	300	385	775	10000	10KV/5KA	1	405	1050
20D511KH	510	459-561	320	418	842	10000	10KV/5KA	1	445	1000
20D561KH	560	504-616	350	460	920	10000	10KV/5KA	1	475	970
20D621KH	620	558-682	385	505	1025	10000	10KV/5KA	1	490	950
20D681KH	680	612-748	420	560	1120	10000	10KV/5KA	1	500	900
20D751KH	750	675-825	460	615	1240	10000	10KV/5KA	1	525	850
20D781KH	780	702-858	485	640	1290	10000	10KV/5KA	1	530	750
20D821KH	820	738-902	510	670	1355	10000	10KV/5KA	1	545	700
20D911KH	910	919-1001	550	745	1500	10000	10KV/5KA	1	595	600
20D951KH	950	855-1045	580	780	1570	10000	10KV/5KA	1	610	580
20D102KH	1000	900-1100	625	825	1650	10000	10KV/5KA	1	650	500
20D112KH	1100	990-1210	680	895	1815	10000	10KV/5KA	1	720	450
20D152KH	1500	1350-1650	900	1220	2475	10000	10KV/5KA	1	790	400
20D182KH	1800	1620-1980	1000	1465	2970	10000	10KV/5KA	1	850	220

产品尺寸 单位 (Unit) :mm

产品外形 Product shape	系列 Series	压敏电压 Varistor voltage	厚度 T max
	20D	18V-39V	5.1
		47V-68V	5.6
		82V-150V	5.1
		180V-270V	5.7
		330V-390V	6.1
		430V-560V	6.7
		620V-780V	7.7
		820V-1200V	8.9
		1300V-1500V	10
1600V-1800V	11.8		

产品外形 Product Shape

Bulk Straight 标准外形	Cutting Straight 切短脚	Out Forming 外弯脚	Y-Forming Y型脚	Cutting Bending 折脚
Flat Type 平角型 (M Type)			Inward Bending 内弯型 (D Type)	

20D KH 系列 电气参数 20D KH Series Electrical Parameters

型号规格 Part NO.	Varistor Voltage		Maximum allowable voltage		Maximum Limited Voltage	Withstanding Surge current (1.2/50 μs & 8/20 μs)		Rated Wattage (W)	Energy (10/1000 μs) (J)	Typical Capacitance
	V1mA		AC	DC	V100A	I _{max}	I _n			1KHz
	(V)		(V)		(V)	(A)				(pF)
20D431KH	430	387-473	275	350	710	10000	10KV/5KA	1	380	1100
20D471KH	470	423-517	300	385	775	10000	10KV/5KA	1	405	1050
20D511KH	510	459-561	320	418	842	10000	10KV/5KA	1	445	1000
20D561KH	560	504-616	350	460	920	10000	10KV/5KA	1	475	970
20D621KH	620	558-682	385	505	1025	10000	10KV/5KA	1	490	950
20D681KH	680	612-748	420	560	1120	10000	10KV/5KA	1	500	900
20D751KH	750	675-825	460	615	1240	10000	10KV/5KA	1	525	850
20D781KH	780	702-858	485	640	1290	10000	10KV/5KA	1	530	750
20D821KH	820	738-902	510	670	1355	10000	10KV/5KA	1	545	700
20D911KH	910	919-1001	550	745	1500	10000	10KV/5KA	1	595	600
20D951KH	950	855-1045	580	780	1570	10000	10KV/5KA	1	610	580
20D102KH	1000	900-1100	625	825	1650	10000	10KV/5KA	1	650	500
20D112KH	1100	990-1210	680	895	1815	10000	10KV/5KA	1	720	450
20D152KH	1500	1350-1650	900	1220	2475	10000	10KV/5KA	1	790	400
20D182KH	1800	1620-1980	1000	1465	2970	10000	10KV/5KA	1	850	220

产品尺寸 单位 (Unit) :mm

产品外形 Product shape	系列 Series	压敏电压 Varistor voltage	厚度 T max
	20D	18V-39V	5.1
		47V-68V	5.6
		82V-150V	5.1
		180V-270V	5.7
		330V-390V	6.1
		430V-560V	6.7
		620V-780V	7.7
		820V-1200V	8.9
		1300V-1500V	10
1600V-1800V	11.8		

产品外形 Product Shape

Bulk Straight 标准外形	Cutting Straight 切短脚	Out Forming 外弯脚	Y-Forming Y型脚	Cutting Bending 折脚
Flat Type 平角型 (M Type)			Inward Bending 内弯型 (D Type)	

25D 系列电气参数 25D Series Electrical Parameters

型号规格 Part NO.	Varistor Voltage		Maximum allowable voltage		Maximum Limited Voltage	Withstanding Surge current (1.2/50 μ s & 8/20 μ s)		Rated Wattage (W)	Energy (10/1000 μ s) (J)	Typical Capacitance
	V1mA		AC	DC	V150A	I _{max}	I _n			1KHz
	(V)		(V)		(V)	(A)				(pF)
25D201K	200	185-225	130	170	340	20	10	1	125	2.4K
25D221K	220	198-242	140	180	360	20	10	1	130	2.2k
25D241K	240	216-264	150	200	395	20	10	1	145	2.0K
25D271K	270	243-297	175	225	455	20	10	1	170	1.7K
25D301K	300	270-330	190	250	500	20	10	1	180	1.6K
25D331K	330	297-363	210	275	550	20	10	1	185	1.5K
25D361K	360	324-396	230	300	595	20	10	1	190	1.4K
25D391K	390	351-429	250	320	650	20	10	1	210	1.2K
25D431K	430	387-473	275	350	710	20	10	1	225	1.1K
25D471K	470	423-517	300	385	775	20	10	1	225	1.05K
25D511K	510	459-561	320	415	845	20	10	1	230	1.0K
25D561K	560	504-616	350	460	925	20	10	1	230	0.95K
25D621K	620	558-682	385	505	1025	20	10	1	230	0.90K
25D681K	680	612-748	420	560	1120	20	10	1	250	0.85K
25D821K	820	738-902	510	670	1355	20	10	1	300	0.70K
25D911K	910	819-1001	550	745	1500	20	10	1	340	0.65K
25D102K	1.0K	900-1000	625	825	1650	20	10	1	375	0.60K
25D122K	1.2K	1080-1320	750	980	1980	20	10	1	400	0.55K
25D152K	1.4K	1150-1650	900	1220	2475	20	10	1	500	0.52K
25D182K	1.8K	1620-1980	1000	1465	2970	20	10	1	700	0.45K

注：压敏电压测试电流DC1Ma 工作环境温度：-45℃~+85℃ 加强型温度：-45℃~+125℃ 压敏电压温度变化率：<0.05/℃

Note: Voltage-sensitive voltage test current DC1Ma working environment temperature: -45~85, intensified temperature: -45+125, temperature change rate of voltage-sensitive voltage: < 0.05/

产品尺寸 单位 (Unit) :mm

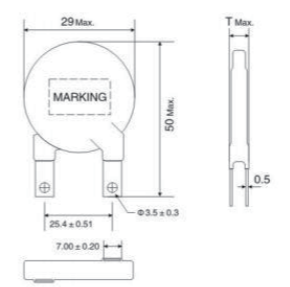
产品外形 Product shape	系列 Series	压敏电压 Varistor voltage	厚度 T max
	25D	201- 271	7.5
		301- 621	9.2
		681- 911	11.2
		102- 122	12.8
		142- 182	16

25D 系列电气参数 25D Series Electrical Parameters

型号规格 Part NO.	Varistor Voltage		Maximum allowable voltage		Maximum Limited Voltage	Withstanding Surge current (1.2/50 μ s & 8/20 μ s)		Rated Wattage	Energy (10/1000 μ s)	Typical Capacitance
	V1mA		AC	DC	V150A	I _{max}	I _n	(W)	(J)	1kHz
	(V)		(V)		(V)	(A)				(pF)
25D201K	200	185-225	130	170	340	20	10	1	125	2.4K
25D221K	220	198-242	140	180	360	20	10	1	130	2.2k
25D241K	240	216-264	150	200	395	20	10	1	145	2.0K
25D271K	270	243-297	175	225	455	20	10	1	170	1.7K
25D301K	300	270-330	190	250	500	20	10	1	180	1.6K
25D331K	330	297-363	210	275	550	20	10	1	185	1.5K
25D361K	360	324-396	230	300	595	20	10	1	190	1.4K
25D391K	390	351-429	250	320	650	20	10	1	210	1.2K
25D431K	430	387-473	275	350	710	20	10	1	225	1.1K
25D471K	470	423-517	300	385	775	20	10	1	225	1.05K
25D511K	510	459-561	320	415	845	20	10	1	230	1.0K
25D561K	560	504-616	350	460	925	20	10	1	230	0.95K
25D621K	620	558-682	385	505	1025	20	10	1	230	0.90K
25D681K	680	612-748	420	560	1120	20	10	1	250	0.85K
25D821K	820	738-902	510	670	1355	20	10	1	300	0.70K
25D911K	910	819-1001	550	745	1500	20	10	1	340	0.65K
25D102K	1.0K	900-1000	625	825	1650	20	10	1	375	0.60K
25D122K	1.2K	1080-1320	750	980	1980	20	10	1	400	0.55K
25D152K	1.4K	1150-1650	900	1220	2475	20	10	1	500	0.52K
25D182K	1.8K	1620-1980	1000	1465	2970	20	10	1	700	0.45K

注：压敏电压测试电流DC1Ma 工作环境温度：-45℃~+85℃ 加强型温度：-45℃~+125℃ 压敏电压温度变化率：<0.05/℃

Note: Voltage-sensitive voltage test current DC1Ma working environment temperature: -45~85, intensified temperature: -45+125, temperature change rate of voltage-sensitive voltage: < 0.05/

产品尺寸 单位 (Unit) :mm

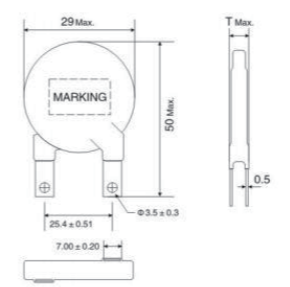
产品外形 Product shape	系列 Series	压敏电压 Varistor voltage	厚度 T max
	25D	201- 271	7.5
		301- 621	9.2
		681- 911	11.2
		102- 122	12.8
		142- 182	16

32D 系列电气参数 32D Series Electrical Parameters

型号规格 Part NO.	Varistor Voltage		Maximum allowable voltage		Maximum Limited Voltage	Withstanding Surge current (1.2/50 μs & 8/20 μs)		Rated Wattage	Energy (10/1000 μs)	Typical Capacitance
	V1mA		AC	DC	V200A	I _{max}	I _n	(W)	(J)	1KHz
	(V)		(V)		(V)	(A)				(pF)
32D201K	200	185-225	130	170	340	25	15	1.2	210	4.2K
32D221K	220	198-242	140	180	360	25	15	1.2	220	3.8K
32D241K	240	216-264	150	200	395	25	15	1.2	240	3.5K
32D271K	270	243-297	175	225	455	25	15	1.2	255	3.2K
32D301K	300	270-330	190	250	500	25	15	1.2	275	2.9K
32D331K	330	297-363	210	275	550	25	15	1.2	300	2.7K
32D361K	360	324-396	230	300	595	25	15	1.2	325	2.5K
32D391K	390	351-429	250	320	650	25	15	1.2	350	2.3K
32D431K	430	387-473	275	350	710	25	15	1.2	400	2.1K
32D471K	470	423-517	300	385	775	25	15	1.2	405	1.8K
32D511K	510	459-561	320	415	845	25	15	1.2	405	1.7K
32D561K	560	504-616	350	460	925	25	15	1.2	410	1.6K
32D621K	620	558-682	385	505	1025	25	15	1.2	415	1.3K
32D681K	680	612-748	420	560	1120	25	15	1.2	450	1.2K
32D821K	820	738-902	510	670	1355	25	15	1.2	545	0.96K
32D911K	910	819-1001	550	745	1500	25	15	1.2	600	0.89K
32D102K	1.0K	900-1100	625	825	1650	25	15	1.2	620	0.83K
32D122K	1.2K	1080-1320	750	980	1980	25	15	1.2	630	0.76K
32D152K	1.5K	1350-1650	900	1220	2475	25	15	1.2	780	0.56K
32D182K	1.8K	1620-1980	1000	1465	2970	25	15	1.2	850	0.52K

注：压敏电压测试电流DC1mA 工作环境温度：-45℃~+85℃ 加强型温度：-45℃~+125℃ 压敏电压温度变化率：<0.05/℃

Note: Voltage-sensitive voltage test current DC1Ma working environment temperature: -45~85, intensified temperature: -45+125, temperature change rate of voltage-sensitive voltage: < 0.05/

产品尺寸 单位 (Unit) :mm

产品外形 Product shape	系列 Series	压敏电压 Varistor voltage	厚度 T max
	32D	201-271	7.5
		301-621	9.5
		681-911	11.2
		102-122	12.8
		142-182	16



32D 系列电气参数 32D Series Electrical Parameters

型号规格 Part NO.	Varistor Voltage		Maximum allowable voltage		Maximum Limited Voltage	Withstanding Surge current (1.2/50 μ s & 8/20 μ s)		Rated Wattage	Energy (10/1000 μ s)	Typical Capacitance
	V1mA		AC	DC	V200A	I _{max}	I _n	(W)	(J)	1KHz
	(V)		(V)		(V)	(A)				(pF)
32D201K	200	185-225	130	170	340	25	15	1.2	210	4.2K
32D221K	220	198-242	140	180	360	25	15	1.2	220	3.8k
32D241K	240	216-264	150	200	395	25	15	1.2	240	3.5K
32D271K	270	243-297	175	225	455	25	15	1.2	255	3.2K
32D301K	300	270-330	190	250	500	25	15	1.2	275	2.9K
32D331K	330	297-363	210	275	550	25	15	1.2	300	2.7K
32D361K	360	324-396	230	300	595	25	15	1.2	325	2.5K
32D391K	390	351-429	250	320	650	25	15	1.2	350	2.3K
32D431K	430	387-473	275	350	710	25	15	1.2	400	2.1K
32D471K	470	423-517	300	385	775	25	15	1.2	405	1.8K
32D511K	510	459-561	320	415	845	25	15	1.2	405	1.7K
32D561K	560	504-616	350	460	925	25	15	1.2	410	1.6K
32D621K	620	558-682	385	505	1025	25	15	1.2	415	1.3K
32D681K	680	612-748	420	560	1120	25	15	1.2	450	1.2K
32D821K	820	738-902	510	670	1355	25	15	1.2	545	0.96K
32D911K	910	819-1001	550	745	1500	25	15	1.2	600	0.89K
32D102K	1.0K	900-1100	625	825	1650	25	15	1.2	620	0.83K
32D122K	1.2K	1080-1320	750	980	1980	25	15	1.2	630	0.76K
32D152K	1.5K	1350-1650	900	1220	2475	25	15	1.2	780	0.56K
32D182K	1.8K	1620-1980	1000	1465	2970	25	15	1.2	850	0.52K

注：压敏电压测试电流DC1mA 工作环境温度：-45℃~+85℃ 加强型温度：-45℃~+125℃ 压敏电压温度变化率：<0.05/℃

Note: Voltage-sensitive voltage test current DC1Ma working environment temperature: -45~85, intensified temperature: -45+125, temperature change rate of voltage-sensitive voltage: < 0.05/

产品尺寸 单位 (Unit) :mm

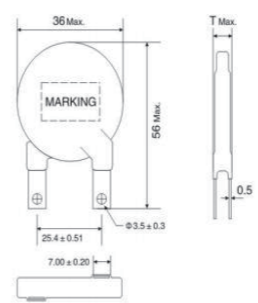
产品外形 Product shape	系列 Series	压敏电压 Varistor voltage	厚度 T max
	32D	201-271	7.5
		301-621	9.5
		681-911	11.2
		102-122	12.8
		142-182	16

34S 系列电气参数 34S Series Electrical Parameters

型号规格 Part NO.	Varistor Voltage		Maximum allowable voltage		Maximum Limited Voltage	Withstanding Surge current (1.2/50 μs & 8/20 μs)		Rated Wattage (W)	Energy (10/1000 μs) (J)	Typical Capacitance
	V1mA		AC	DC	V300A	I _{max}	I _n			1KHz
	(V)		(V)							
34S201K	200	185-225	130	170	340	40K	20K	1.4	260	5980
34S221K	220	198-242	140	180	360	40K	20K	1.4	280	5520
34S241K	240	216-264	150	200	395	40K	20K	1.4	300	5050
34S271K	270	243-297	175	225	455	40K	20K	1.4	340	4600
34S301K	300	270-330	190	250	500	40K	20K	1.4	360	4230
34S331K	330	297-363	210	275	550	40K	20K	1.4	380	3950
34S361K	360	324-396	230	300	595	40K	20K	1.4	405	3680
34S391K	390	351-429	250	320	650	40K	20K	1.4	435	3300
34S431K	430	387-473	275	350	710	40K	20K	1.4	500	2900
34S471K	470	423-517	300	385	775	40K	20K	1.4	505	2660
34S511K	510	459-561	320	415	845	40K	20K	1.4	505	2500
34S561K	560	504-616	350	460	925	40K	20K	1.4	510	2300
34S621K	620	558-682	385	505	1025	40K	20K	1.4	515	1840
34S681K	680	612-748	420	560	1120	40K	20K	1.4	560	1750
34S821K	820	738-902	510	670	1355	40K	20K	1.4	680	1500
34S911K	910	819-1001	550	745	1500	40K	20K	1.4	750	1380
34S102K	1.0K	900-1000	625	825	1815	40K	20K	1.4	780	1190
34S122K	1.2K	1080-1320	750	980	2000	40K	20K	1.4	800	1100

注：压敏电压测试电流DC1Ma 工作环境温度：-45℃~+85℃ 加强型温度：-45℃~+125℃ 压敏电压温度变化率：<0.05/℃

Note: Voltage-sensitive voltage test current DC1Ma working environment temperature: -45~85, intensified temperature: -45+125, temperature change rate of voltage-sensitive voltage: < 0.05/

产品尺寸 单位 (Unit) :mm

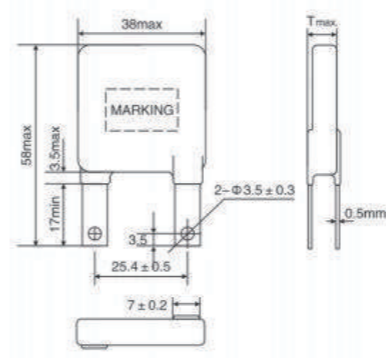
产品外形 Product shape	系列 Series	压敏电压 Varistor voltage	厚度 T max
 <p>说明：导电电极形状可按客户要求生产。 Option: The shape of conductive electrode can be customized.</p>	34S	201-271	7.5
		301-621	9.5
		681-911	11.2
		102-122	12.8

Disclaimer

Specifications are subject to change without notice.

The device characteristics and parameters in this data sheet can and do vary in different applications and actual device performance may vary over time.

Users should verify actual device performance in their specific applications.

34S 系列电气参数 34S Series Electrical Parameters

型号规格 Part NO.	Varistor Voltage		Maximum allowable voltage		Maximum Limited Voltage	Withstanding Surge current (1.2/50 μs & 8/20 μs)		Rated Wattage (W)	Energy (10/1000 μs) (J)	Typical Capacitance
	V1mA		AC	DC	V300A	I _{max}	I _n			1KHz
	(V)		(V)							
34S201K	200	185-225	130	170	340	40K	20K	1.4	260	5980
34S221K	220	198-242	140	180	360	40K	20K	1.4	280	5520
34S241K	240	216-264	150	200	395	40K	20K	1.4	300	5050
34S271K	270	243-297	175	225	455	40K	20K	1.4	340	4600
34S301K	300	270-330	190	250	500	40K	20K	1.4	360	4230
34S331K	330	297-363	210	275	550	40K	20K	1.4	380	3950
34S361K	360	324-396	230	300	595	40K	20K	1.4	405	3680
34S391K	390	351-429	250	320	650	40K	20K	1.4	435	3300
34S431K	430	387-473	275	350	710	40K	20K	1.4	500	2900
34S471K	470	423-517	300	385	775	40K	20K	1.4	505	2660
34S511K	510	459-561	320	415	845	40K	20K	1.4	505	2500
34S561K	560	504-616	350	460	925	40K	20K	1.4	510	2300
34S621K	620	558-682	385	505	1025	40K	20K	1.4	515	1840
34S681K	680	612-748	420	560	1120	40K	20K	1.4	560	1750
34S821K	820	738-902	510	670	1355	40K	20K	1.4	680	1500
34S911K	910	819-1001	550	745	1500	40K	20K	1.4	750	1380
34S102K	1.0K	900-1000	625	825	1815	40K	20K	1.4	780	1190
34S122K	1.2K	1080-1320	750	980	2000	40K	20K	1.4	800	1100

注：压敏电压测试电流DC1Ma 工作环境温度：-45℃~+85℃ 加强型温度：-45℃~+125℃ 压敏电压温度变化率：<0.05/℃

Note: Voltage-sensitive voltage test current DC1Ma working environment temperature: -45~85, intensified temperature: -45+125, temperature change rate of voltage-sensitive voltage: < 0.05/

产品尺寸 单位 (Unit) :mm

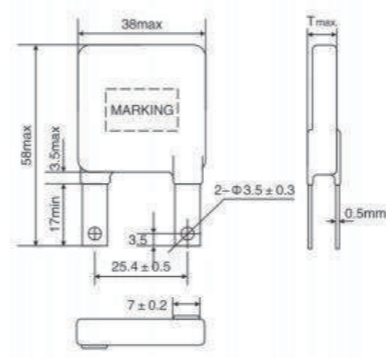
产品外形 Product shape	系列 Series	压敏电压 Varistor voltage	厚度 T max
 <p>说明：导电电极形状可按客户要求生产。 Option: The shape of conductive electrode can be customized.</p>	34S	201-271	7.5
		301-621	9.5
		681-911	11.2
		102-122	12.8

Disclaimer

Specifications are subject to change without notice.
The device characteristics and parameters in this data sheet can and do vary in different applications and actual device performance may vary over time.
Users should verify actual device performance in their specific applications.

自恢复保险丝 PPTC (Polymeric Positive Temperature Coefficient)

正温度系数器件，也就是人们所说的自恢复保险丝，为电子电路或者电子设备提供过流保护。PTCs的电阻随着温度的升高而升高，利用这个特性，当安全电流通过时，阻值变化很小，当有异常的电流时，阻值剧烈变化，达到限制异常电流的目的。当异常排除，温度回到安全水平时，阻值自动“重置”。

YINT提供的正温度系数聚合物（PPTC）作为一种过流保护器件，可以减少保修，维护和维修成本。是异常过电流频繁区域设备或者高可靠性设备的理想选择。常被应用在消费电子，电源线，电信，I/O口，过程控制和医疗设备。



Positive temperature coefficient devices, also known as re-settable fuses, providing over-current protection for electronic circuits and devices. The resistance of PTCs rises as the temperature rises. With this feature, the value change of resistance is not obvious when the safe current passes, the resistance value changes drastically when abnormal current passes, this reaches the purpose of limiting abnormal current, the resistance value will “reset” automatically when the abnormality is eliminated and temperature returns to a safe level. YINT offers a polymeric positive temperature coefficient (PPTC) as an over-current protection device that could reduce the costs of warranty and maintenance. It is an ideal choice for equipment with frequent abnormal over-current flowing area. PPTC often used in consumer electronics, power lines, telecommunications, I/O connectors, process control and medical equipment.

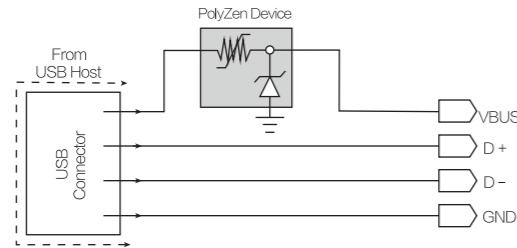

插件系列 Radial leaded series

- ▲ 保护电压最高到600Vdc Protection devices up to 600Vdc
- ▲ 非常高的保持电流 A very high hold current
- ▲ 低电流比 Low trip- to- hold current ratio
- ▲ 低阻抗 Low resistance

贴片产品 Surface mount devices

- ▲ 小体积设计 Small volume design
- ▲ 低保持电流 Low hold current
- ▲ 快速响应 Very fast trip current
- ▲ 低阻抗 Low resistance

假如以下产品不能满足您的要求，一定条件下我们也可以提供定制产品，具体可联系YINT电子。

If your application requirements fall outside of our product range, in certain instances we can offer customized solutions. Please contact YINT for more information.

I_h	Hold current: maximum current at which the device will not trip at 25 still air	保持电流: 25度环境温度下，器件不断开的最大电流值
I_t	Trip current minimum current at which the device will always trip at 25°C still air	断开电流: 25度环境温度下，让器件断开的最小电流值
V_{MAX}	Maximum voltage device can withstand without damage at rated current	器件耐压值
I_{MAX}	Maximum fault current device can withstand without damage at rated voltage	器件能承受的最大异常电流
T_{trip}	Maximum time to trip at 5 times hold current	5倍 I_h 下器件断开的最长时间
R_{MAX}	Maximum device resistance at 25 prior to tripping	25度下器件的最大阻值
R_{MIN}	Minimum device resistance at 25 prior to tripping	25度下器件的最小阻值
P_{dtyp}	Typical power dissipation from device when in the tripped state at 25°C still air	典型功耗: 25度环境温度下，器件断开状态的典型功耗

Test Procedures and Requirements

Test	Test Conditions	Accept/Reject Criteria
Resistance	In still air @ 25°C	$R_{min} \leq R \leq R_{1max}$
Time to Trip	V_{max} , 25°C, In still air @ 25°C	$T \leq \text{max. time to trip (seconds)}$
Hold Current	30 min. at I_H , In still air @ 25°C	No trip
Trip Cycle Life	V_{max} , I_{max} , 100 cycles, In still air @ 25°C	No arcing or burning
Trip Endurance	V_{max} , 1 hours, In still air @ 25°C	No arcing or burning

自恢复保险丝 PPTC (Polymeric Positive Temperature Coefficient)

正温度系数器件，也就是人们所说的自恢复保险丝，为电子电路或者电子设备提供过流保护。PTCs的电阻随着温度的升高而升高，利用这个特性，当安全电流通过时，阻值变化很小，当有异常的电流时，阻值剧烈变化，达到限制异常电流的目的。当异常排除，温度回到安全水平时，阻值自动“重置”。

YINT提供的正温度系数聚合物（PPTC）作为一种过流保护器件，可以减少保修，维护和维修成本。是异常过电流频繁区域设备或者高可靠性设备的理想选择。常被应用在消费电子，电源线，电信，I/O口，过程控制和医疗设备。



Positive temperature coefficient devices, also known as re-settable fuses, providing over-current protection for electronic circuits and devices. The resistance of PTCs rises as the temperature rises. With this feature, the value change of resistance is not obvious when the safe current passes, the resistance value changes drastically when abnormal current passes, this reaches the purpose of limiting abnormal current, the resistance value will “reset” automatically when the abnormality is eliminated and temperature returns to a safe level. YINT offers a polymeric positive temperature coefficient (PPTC) as an over-current protection device that could reduce the costs of warranty and maintenance. It is an ideal choice for equipment with frequent abnormal over-current flowing area. PPTC often used in consumer electronics, power lines, telecommunications, I/O connectors, process control and medical equipment.

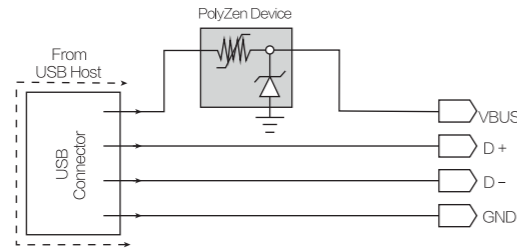

插件系列 Radial leaded series

- ▲ 保护电压最高到600Vdc Protection devices up to 600Vdc
- ▲ 非常高的保持电流 A very high hold current
- ▲ 低电流比 Low trip-to-hold current ratio
- ▲ 低阻抗 Low resistance

贴片产品 Surface mount devices

- ▲ 小体积设计 Small volume design
- ▲ 低保持电流 Low hold current
- ▲ 快速响应 Very fast trip current
- ▲ 低阻抗 Low resistance

假如以下产品不能满足您的要求，一定条件下我们也可以提供定制产品，具体可联系YINT电子。

If your application requirements fall outside of our product range, in certain instances we can offer customized solutions. Please contact YINT for more information.

I_h	Hold current: maximum current at which the device will not trip at 25 still air	保持电流: 25度环境温度下，器件不断开的最大电流值
I_t	Trip current minimum current at which the device will always trip at 25°C still air	断开电流: 25度环境温度下，让器件断开的最小电流值
V_{MAX}	Maximum voltage device can withstand without damage at rated current	器件耐压值
I_{MAX}	Maximum fault current device can withstand without damage at rated voltage	器件能承受的最大异常电流
T_{trip}	Maximum time to trip at 5 times hold current	5倍 I_h 下器件断开的最长时间
R_{MAX}	Maximum device resistance at 25 prior to tripping	25度下器件的最大阻值
R_{MIN}	Minimum device resistance at 25 prior to tripping	25度下器件的最小阻值
P_{dtyp}	Typical power dissipation from device when in the tripped state at 25°C still air	典型功耗: 25度环境温度下，器件断开状态的典型功耗

Test Procedures and Requirements

Test	Test Conditions	Accept/Reject Criteria
Resistance	In still air @ 25°C	$R_{min} \leq R \leq R_{1max}$
Time to Trip	V_{max} , 25°C, In still air @ 25°C	$T \leq \text{max. time to trip (seconds)}$
Hold Current	30 min. at I_H , In still air @ 25°C	No trip
Trip Cycle Life	V_{max} , I_{max} , 100 cycles, In still air @ 25°C	No arcing or burning
Trip Endurance	V_{max} , 1 hours, In still air @ 25°C	No arcing or burning

Product Dimensions

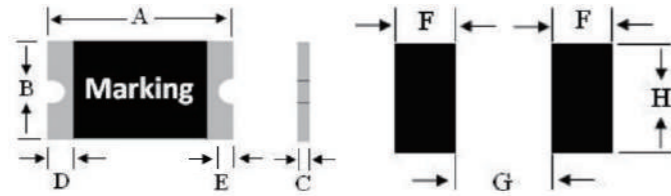

Model	Dimensions (mm)							
	A(min)	A(max)	B(min)	B(max)	C(min)	C(max)	D(min)	E(min)
SMD0603	1.45	1.85	0.65	1.05	0.4	0.75	0.15	0.4
SMD0805	2.00	2.20	1.20	1.50	0.40	1.20	0.20	0.10
SMD1206	3.00	3.50	1.50	1.80	0.35	1.70	0.15	0.10
SMD1210	3.00	3.43	2.35	2.80	0.35	1.50	0.15	0.10
SMD1812	4.37	4.73	3.07	3.41	0.30	1.70	0.30	0.15
SMD2920	6.73	7.98	4.8	5.44	0.40	1.20	0.30	0.15

Recommended Solder Pad Layout Dimensions (mm)

Device	F	G	H
	Normal Value	Normal Value	Normal Value
0603 Series	1.0	0.8	1.0
0805 Series	1	1.2	1.5
1206 Series	1	1.9±1	1.9±1
1210 Series	1	2±0.1	2.5±0.1
1812 Series	1.78	3.2	3.2
2920 Series	2.3	5.1	5.6

PPTC SMD0603 Series

▲ Features:

- RoHS Compliant & Halogen Free
- Faster tripping, 0603 Dimension, Surface mountable, Solid state
- Maximum Voltage: 6~30Vdc
- Operating Current: 0.35A~3.0A,
- Operating Temperature: -40°C TO 85°C

Thermal Derating Chart-IH (A)

Model	Maximum ambient operating temperatures (°C)									
	-40	-20	0	25	40	50	60	70	85	
SMD0603-003-30V	0.042	0.038	0.035	0.03	0.026	0.021	0.018	0.015	0.011	
SMD0603-004-24V	0.056	0.05	0.046	0.04	0.034	0.028	0.024	0.02	0.014	
SMD0603-005-24V	0.07	0.063	0.058	0.05	0.043	0.035	0.03	0.025	0.018	
SMD0603-010-15V	0.14	0.125	0.115	0.10	0.085	0.07	0.06	0.05	0.035	
SMD0603-020-9V	0.28	0.25	0.23	0.20	0.17	0.14	0.12	0.10	0.07	
SMD0603-025-9V	0.35	0.31	0.29	0.25	0.21	0.18	0.15	0.13	0.09	
SMD0603-030-6V	0.42	0.38	0.35	0.30	0.26	0.21	0.18	0.15	0.11	
SMD0603-035-6V	0.47	0.44	0.39	0.35	0.30	0.27	0.24	0.20	0.14	
SMD0603-040-6V	0.54	0.50	0.45	0.40	0.34	0.31	0.27	0.23	0.16	
SMD0603-050-6V	0.67	0.63	0.56	0.50	0.43	0.39	0.34	0.29	0.20	

Electrical Characteristic

Model	IHold	ITrip	Vmax	I _{max}	Pd Max	Maximum Time to Trip		Resistance (Ω)	
	(A)	(A)	V (DC)	A	W	Current (A)	Time (S)	Rmin	Rmax
SMD0603-003-30V	0.03	0.09	30	20	0.50	0.15	1.0	6.0	65.0
SMD0603-004-24V	0.04	0.12	24	20	0.50	0.20	1.0	4.0	45.0
SMD0603-005-24V	0.05	0.15	24	20	0.50	0.20	1.0	3.0	35.0
SMD0603-010-15V	0.10	0.30	15	40	0.50	0.50	1.0	0.9	8.00
SMD0603-020-9V	0.20	0.50	9	40	0.50	1.00	0.60	0.55	3.50
SMD0603-025-9V	0.25	0.55	9	40	0.50	8.0	0.08	0.50	3.00
SMD0603-030-6V	0.30	0.70	6	40	0.70	8.0	0.10	0.30	2.00
SMD0603-035-6V	0.35	0.75	6	40	0.75	8.0	0.10	0.20	1.40
SMD0603-040-6V	0.40	0.80	6	40	0.80	8.0	0.10	0.20	0.90
SMD0603-050-6V	0.50	1.00	6	40	1.00	8.0	0.10	0.10	0.80

Product Dimensions

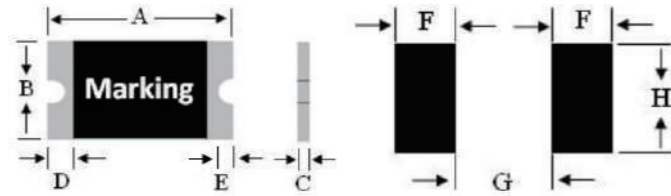

Model	Dimensions (mm)							
	A(min)	A(max)	B(min)	B(max)	C(min)	C(max)	D(min)	E(min)
SMD0603	1.45	1.85	0.65	1.05	0.4	0.75	0.15	0.4
SMD0805	2.00	2.20	1.20	1.50	0.40	1.20	0.20	0.10
SMD1206	3.00	3.50	1.50	1.80	0.35	1.70	0.15	0.10
SMD1210	3.00	3.43	2.35	2.80	0.35	1.50	0.15	0.10
SMD1812	4.37	4.73	3.07	3.41	0.30	1.70	0.30	0.15
SMD2920	6.73	7.98	4.8	5.44	0.40	1.20	0.30	0.15

Recommended Solder Pad Layout Dimensions (mm)

Device	F	G	H
	Normal Value	Normal Value	Normal Value
0603 Series	1.0	0.8	1.0
0805 Series	1	1.2	1.5
1206 Series	1	1.9±1	1.9±1
1210 Series	1	2±0.1	2.5±0.1
1812 Series	1.78	3.2	3.2
2920 Series	2.3	5.1	5.6

PPTC SMD0603 Series

▲ Features:

- RoHS Compliant & Halogen Free
- Faster tripping, 0603 Dimension, Surface mountable, Solid state
- Maximum Voltage: 6~30Vdc
- Operating Current: 0.35A~3.0A,
- Operating Temperature: -40°C TO 85°C

Thermal Derating Chart-IH (A)

Model	Maximum ambient operating temperatures (°C)									
	-40	-20	0	25	40	50	60	70	85	
SMD0603-003-30V	0.042	0.038	0.035	0.03	0.026	0.021	0.018	0.015	0.011	
SMD0603-004-24V	0.056	0.05	0.046	0.04	0.034	0.028	0.024	0.02	0.014	
SMD0603-005-24V	0.07	0.063	0.058	0.05	0.043	0.035	0.03	0.025	0.018	
SMD0603-010-15V	0.14	0.125	0.115	0.10	0.085	0.07	0.06	0.05	0.035	
SMD0603-020-9V	0.28	0.25	0.23	0.20	0.17	0.14	0.12	0.10	0.07	
SMD0603-025-9V	0.35	0.31	0.29	0.25	0.21	0.18	0.15	0.13	0.09	
SMD0603-030-6V	0.42	0.38	0.35	0.30	0.26	0.21	0.18	0.15	0.11	
SMD0603-035-6V	0.47	0.44	0.39	0.35	0.30	0.27	0.24	0.20	0.14	
SMD0603-040-6V	0.54	0.50	0.45	0.40	0.34	0.31	0.27	0.23	0.16	
SMD0603-050-6V	0.67	0.63	0.56	0.50	0.43	0.39	0.34	0.29	0.20	

Electrical Characteristic

Model	IHold	ITrip	Vmax	I _{max}	Pd Max	Maximum Time to Trip		Resistance (Ω)	
	(A)	(A)	V (DC)	A	W	Current (A)	Time (S)	Rmin	Rmax
SMD0603-003-30V	0.03	0.09	30	20	0.50	0.15	1.0	6.0	65.0
SMD0603-004-24V	0.04	0.12	24	20	0.50	0.20	1.0	4.0	45.0
SMD0603-005-24V	0.05	0.15	24	20	0.50	0.20	1.0	3.0	35.0
SMD0603-010-15V	0.10	0.30	15	40	0.50	0.50	1.0	0.9	8.00
SMD0603-020-9V	0.20	0.50	9	40	0.50	1.00	0.60	0.55	3.50
SMD0603-025-9V	0.25	0.55	9	40	0.50	8.0	0.08	0.50	3.00
SMD0603-030-6V	0.30	0.70	6	40	0.70	8.0	0.10	0.30	2.00
SMD0603-035-6V	0.35	0.75	6	40	0.75	8.0	0.10	0.20	1.40
SMD0603-040-6V	0.40	0.80	6	40	0.80	8.0	0.10	0.20	0.90
SMD0603-050-6V	0.50	1.00	6	40	1.00	8.0	0.10	0.10	0.80

PPTC SMD0805 Series

- ▲ Features:
- RoHS Compliant & Halogen Free
- Faster tripping, 0805 Dimension, Surface mountable, Solid state
- Maximum Voltage: 6~15Vdc
- Operating Current: 0.05A~1.10A,
- Operating Temperature: -40°C TO 85°C

Thermal Derating Chart-IH (A)

Model	Maximum ambient operating temperatures (°C)								
	-40	-20	0	25	40	50	60	70	85
SMD0805-005-15V	0.07	0.06	0.055	0.05	0.04	0.35	0.3	0.25	0.15
SMD0805-010-15V	0.14	0.12	0.11	0.1	0.8	0.7	0.6	0.5	0.3
SMD0805-020-9V	0.28	0.25	0.23	0.20	0.17	0.14	0.12	0.10	0.07
SMD0805-035-6V	0.47	0.44	0.39	0.35	0.30	0.27	0.24	0.20	0.14
SMD0805-050-6V	0.68	0.62	0.55	0.50	0.40	0.37	0.33	0.29	0.23
SMD0805-075-6V	1.00	0.90	0.79	0.75	0.63	0.57	0.53	0.41	0.34
SMD0805-100-6V	1.35	1.25	1.10	1.00	0.82	0.74	0.65	0.55	0.42
SMD0805-110-6V	1.45	1.35	1.20	1.10	0.92	0.84	0.75	0.65	0.52

Electrical Characteristic

Model	IHold	ITrip	Vmax	Imax	Pd Max	Maximum Time to Trip		Resistance (Ω)	
	(A)	(A)	V (DC)	A	W	Current (A)	Time (S)	Rmin	Rmax
SMD0805-005-15V	15	100	0.05	0.15	0.5	0.5	2.00	2.00	50.0
SMD0805-010-15V	15	100	0.10	0.30	0.5	0.5	1.50	1.00	6.00
SMD0805-020-9V	9	100	0.20	0.50	0.5	8.0	0.02	0.50	3.50
SMD0805-035-6V	6	100	0.35	0.75	0.5	8.0	0.10	0.25	1.20
SMD0805-050-6V	6	100	0.50	1.00	0.6	8.0	0.10	0.15	0.85
SMD0805-075-6V	6	100	0.75	1.50	0.6	8.0	0.20	0.09	0.385
SMD0805-100-6V	6	100	1.00	1.95	0.6	8.0	0.30	0.06	0.23
SMD0805-110-6V	6	100	1.10	2.20	0.6	8.0	0.30	0.06	0.21

PPTC SMD1206 Series Surface-mount Devices

- ▲ Features:
- RoHS Compliant & Halogen Free
- Faster tripping, 1206 Dimension, Surface mountable, Solid state
- Maximum Voltage: 6~60Vdc
- Operating Current: 0.05A~2A,
- Operating Temperature: -40°C TO 85°C

Thermal Derating Chart-IH (A)

Model	Maximum ambient operating temperatures (°C)								
	-40	-20	0	25	40	50	60	70	85
SMD1206-005-60V	0.09	0.08	0.06	0.05	0.04	0.036	0.033	0.029	0.02
SMD1206-010-60V	0.18	0.16	0.12	0.1	0.08	0.072	0.066	0.058	0.04
SMD1206-010-33V	0.18	0.16	0.12	0.1	0.08	0.072	0.066	0.058	0.04
SMD1206-012-30V	0.216	0.192	0.144	0.12	0.096	0.086	0.079	0.070	0.048
SMD1206-016-30V	0.288	0.256	0.192	0.160	0.128	0.115	0.106	0.093	0.064
SMD1206-020-24V	0.31	0.26	0.22	0.20	0.18	0.16	0.15	0.13	0.07
SMD1206-025-16V	0.37	0.33	0.29	0.25	0.22	0.20	0.17	0.15	0.12
SMD1206-030-16V	0.444	0.396	0.348	0.30	0.264	0.24	0.204	0.18	0.144
SMD1206-035-16V	0.50	0.45	0.40	0.35	0.30	0.27	0.24	0.21	0.15
SMD1206-050-6V	0.71	0.64	0.57	0.50	0.42	0.39	0.35	0.31	0.25
SMD1206-050-13.2	0.71	0.64	0.57	0.50	0.42	0.39	0.35	0.31	0.25
SMD1206-050-16V	0.71	0.64	0.57	0.50	0.42	0.39	0.35	0.31	0.25
SMD1206-050-24V	0.639	0.576	0.513	0.50	0.378	0.351	0.315	0.279	0.225
SMD1206-075-6V	1.14	1.01	0.88	0.75	0.65	0.59	0.54	0.49	0.41
SMD1206-075-13.2V	1.45	1.31	1.15	1.00	0.84	0.77	0.69	0.61	0.48
SMD1206-075-16V	1.305	1.179	1.035	1.00	0.756	0.693	0.621	0.549	0.432
SMD1206-100-6V	1.305	1.179	1.035	1.00	0.756	0.693	0.621	0.549	0.432
SMD1206-100-13.2V	1.595	1.441	1.265	1.10	0.924	0.847	0.759	0.671	0.528
SMD1206-100-16V	2.18	1.94	1.72	1.50	1.28	1.17	1.06	0.96	0.77
SMD1206-110-8V	2.60	2.44	2.35	2.00	1.78	1.67	1.50	1.45	1.10

PPTC SMD0805 Series

- ▲ Features:
- RoHS Compliant & Halogen Free
- Faster tripping, 0805 Dimension, Surface mountable, Solid state
- Maximum Voltage: 6~15Vdc
- Operating Current: 0.05A~1.10A,
- Operating Temperature: -40°C TO 85°C

Thermal Derating Chart-IH (A)

Model	Maximum ambient operating temperatures (°C)								
	-40	-20	0	25	40	50	60	70	85
SMD0805-005-15V	0.07	0.06	0.055	0.05	0.04	0.35	0.3	0.25	0.15
SMD0805-010-15V	0.14	0.12	0.11	0.1	0.8	0.7	0.6	0.5	0.3
SMD0805-020-9V	0.28	0.25	0.23	0.20	0.17	0.14	0.12	0.10	0.07
SMD0805-035-6V	0.47	0.44	0.39	0.35	0.30	0.27	0.24	0.20	0.14
SMD0805-050-6V	0.68	0.62	0.55	0.50	0.40	0.37	0.33	0.29	0.23
SMD0805-075-6V	1.00	0.90	0.79	0.75	0.63	0.57	0.53	0.41	0.34
SMD0805-100-6V	1.35	1.25	1.10	1.00	0.82	0.74	0.65	0.55	0.42
SMD0805-110-6V	1.45	1.35	1.20	1.10	0.92	0.84	0.75	0.65	0.52

Electrical Characteristic

Model	IHold	ITrip	Vmax	Imax	Pd Max	Maximum Time to Trip		Resistance (Ω)	
	(A)	(A)	V (DC)	A	W	Current (A)	Time (S)	Rmin	Rmax
SMD0805-005-15V	15	100	0.05	0.15	0.5	0.5	2.00	2.00	50.0
SMD0805-010-15V	15	100	0.10	0.30	0.5	0.5	1.50	1.00	6.00
SMD0805-020-9V	9	100	0.20	0.50	0.5	8.0	0.02	0.50	3.50
SMD0805-035-6V	6	100	0.35	0.75	0.5	8.0	0.10	0.25	1.20
SMD0805-050-6V	6	100	0.50	1.00	0.6	8.0	0.10	0.15	0.85
SMD0805-075-6V	6	100	0.75	1.50	0.6	8.0	0.20	0.09	0.385
SMD0805-100-6V	6	100	1.00	1.95	0.6	8.0	0.30	0.06	0.23
SMD0805-110-6V	6	100	1.10	2.20	0.6	8.0	0.30	0.06	0.21

PPTC SMD1206 Series Surface-mount Devices

- ▲ Features:
- RoHS Compliant & Halogen Free
- Faster tripping, 1206 Dimension, Surface mountable, Solid state
- Maximum Voltage: 6~60Vdc
- Operating Current: 0.05A~2A,
- Operating Temperature: -40°C TO 85°C

Thermal Derating Chart-IH (A)

Model	Maximum ambient operating temperatures (°C)								
	-40	-20	0	25	40	50	60	70	85
SMD1206-005-60V	0.09	0.08	0.06	0.05	0.04	0.036	0.033	0.029	0.02
SMD1206-010-60V	0.18	0.16	0.12	0.1	0.08	0.072	0.066	0.058	0.04
SMD1206-010-33V	0.18	0.16	0.12	0.1	0.08	0.072	0.066	0.058	0.04
SMD1206-012-30V	0.216	0.192	0.144	0.12	0.096	0.086	0.079	0.070	0.048
SMD1206-016-30V	0.288	0.256	0.192	0.160	0.128	0.115	0.106	0.093	0.064
SMD1206-020-24V	0.31	0.26	0.22	0.20	0.18	0.16	0.15	0.13	0.07
SMD1206-025-16V	0.37	0.33	0.29	0.25	0.22	0.20	0.17	0.15	0.12
SMD1206-030-16V	0.444	0.396	0.348	0.30	0.264	0.24	0.204	0.18	0.144
SMD1206-035-16V	0.50	0.45	0.40	0.35	0.30	0.27	0.24	0.21	0.15
SMD1206-050-6V	0.71	0.64	0.57	0.50	0.42	0.39	0.35	0.31	0.25
SMD1206-050-13.2	0.71	0.64	0.57	0.50	0.42	0.39	0.35	0.31	0.25
SMD1206-050-16V	0.71	0.64	0.57	0.50	0.42	0.39	0.35	0.31	0.25
SMD1206-050-24V	0.639	0.576	0.513	0.50	0.378	0.351	0.315	0.279	0.225
SMD1206-075-6V	1.14	1.01	0.88	0.75	0.65	0.59	0.54	0.49	0.41
SMD1206-075-13.2V	1.45	1.31	1.15	1.00	0.84	0.77	0.69	0.61	0.48
SMD1206-075-16V	1.305	1.179	1.035	1.00	0.756	0.693	0.621	0.549	0.432
SMD1206-100-6V	1.305	1.179	1.035	1.00	0.756	0.693	0.621	0.549	0.432
SMD1206-100-13.2V	1.595	1.441	1.265	1.10	0.924	0.847	0.759	0.671	0.528
SMD1206-100-16V	2.18	1.94	1.72	1.50	1.28	1.17	1.06	0.96	0.77
SMD1206-110-8V	2.60	2.44	2.35	2.00	1.78	1.67	1.50	1.45	1.10

Electrical Characteristic

Model	Vmax	I _{max}	I _{Hold}	I _{Trip}	Maximum Time to Trip		Resistance (Ω)	
	V (DC)	(A)	(A)	(A)	Current (A)	Time (S)	R _{min}	R _{max}
SMD1206-005-60V	60.0	100	0.05	0.15	0.25	1.50	3.600	50.000
SMD1206-010-60V	60.0	100	0.10	0.25	0.5	1.00	1.600	15.000
SMD1206-010-33V	33.0	100	0.10	0.25	0.5	1.00	1.600	15.000
SMD1206-012-30V	30	100	0.12	0.29	1.00	0.20	1.350	10.00
SMD1206-016-30V	30	100	0.16	0.37	1.00	0.30	1.000	4.50
SMD1206-020-24V	24.0	100	0.20	0.46	8.0	0.08	0.350	3.500
SMD1206-025-16V	16.0	100	0.25	0.50	8.0	0.08	0.350	2.500
SMD1206-030-16V	16.0	100	0.30	0.65	8.0	0.10	0.250	2.00
SMD1206-035-16V	16.0	100	0.35	0.75	8.0	0.10	0.250	1.300
SMD1206-050-6V	6.0	100	0.50	1.00	8.0	0.10	0.150	0.700
SMD1206-050-13.2	13.2	100	0.50	1.00	8.0	0.10	0.150	0.700
SMD1206-050-16V	16	100	0.50	1.00	8.0	0.10	0.150	0.750
SMD1206-050-24V	24	100	0.50	1.00	8.0	0.10	0.150	0.750
SMD1206-075-6V	6.0	100	0.75	1.50	8.0	0.20	0.090	0.500
SMD1206-075-13.2V	13.2	100	0.75	1.50	8.0	0.20	0.090	0.500
SMD1206-075-16V	16	100	0.75	1.50	8.0	0.20	0.090	0.500
SMD1206-100-6V	6.0	100	1.00	1.80	8.0	0.30	0.055	0.270
SMD1206-100-13.2V	13.2	100	1.00	1.80	8.0	0.30	0.055	0.270
SMD1206-100-16V	16	100	1.00	1.80	8.0	0.30	0.055	0.330
SMD1206-110-8V	8.0	100	1.10	1.80	8.0	0.30	0.050	0.230
SMD1206-150-6V	6.0	100	1.50	3.00	8.0	1.00	0.040	0.130
SMD1206-200-6V	6.0	100	2.00	3.50	8.0	1.0	0.018	0.080

PPTC SMD1210 Series

▲ Features:

- RoHS Compliant & Halogen Free
- Faster tripping, 1210 Dimension, Surface mountable, Solid state
- Maximum Voltage: 6~60Vdc
- Operating Current: 0.05A~2A,
- Operating Temperature: -40°C TO 85°C

Thermal Derating Chart-IH (A)

Model	Maximum ambient operating temperatures (°C)									
	-40	-20	0	25	40	50	60	70	85	
SMD1210-005-60V	0.08	0.07	0.06	0.05	0.04	0.04	0.03	0.03	0.02	
SMD1210-010-30V	0.16	0.14	0.12	0.10	0.08	0.07	0.06	0.05	0.05	
SMD1210-020-30V	0.29	0.26	0.22	0.20	0.16	0.14	0.13	0.11	0.08	
SMD1210-035-30V	0.47	0.45	0.40	0.35	0.33	0.28	0.24	0.21	0.18	
SMD1210-035-16V	0.47	0.45	0.40	0.35	0.33	0.28	0.24	0.21	0.18	
SMD1210-050-16V	0.76	0.67	0.58	0.50	0.43	0.40	0.36	0.32	0.28	
SMD1210-075-6V	1.00	0.97	0.86	0.75	0.64	0.59	0.54	0.48	0.40	
SMD1210-110-6V	1.60	1.42	1.26	1.10	0.94	0.86	0.80	0.70	0.58	
SMD1210-110-12V	1.60	1.42	1.26	1.10	0.94	0.86	0.80	0.70	0.58	
SMD1210-150-6V	2.30	2.02	1.76	1.50	1.24	1.11	1.00	0.85	0.65	
SMD1210-175-6V	2.45	2.22	2.01	1.75	1.45	1.26	1.10	0.98	0.80	
SMD1210-200-6V	2.60	2.44	2.35	2.00	1.78	1.67	1.50	1.45	1.10	

Electrical Characteristic

Model	Vmax	I _{max}	I _{Hold}	I _{Trip}	Pd Max	Maximum Time to Trip		Resistance (Ω)	
	V (DC)	(A)	(A)	(A)	W	Current (A)	Time (S)	R _{min}	R _{max}
SMD1210-005-60V	60	100	0.05	0.15	0.6	0.25	1.50	2.8	50
SMD1210-010-30V	30	100	0.10	0.30	0.6	0.50	0.60	0.8	15
SMD1210-020-30V	30	100	0.20	0.40	0.6	8.0	0.02	0.40	5
SMD1210-035-30V	30	100	0.35	0.75	0.6	8.0	0.20	0.20	1.3
SMD1210-035-16V	16	100	0.35	0.75	0.6	8.0	0.20	0.20	1.3
SMD1210-050-16V	16	100	0.50	1.00	0.6	8.0	0.10	0.18	0.9
SMD1210-075-6V	6	100	0.75	1.50	0.6	8.0	0.10	0.07	0.4
SMD1210-110-6V	6	100	1.10	2.20	0.6	8.0	0.30	0.05	0.21
SMD1210-110-12V	12	100	1.10	2.20	0.8	8.0	0.30	0.05	0.25
SMD1210-150-6V	6	100	1.50	3.00	0.8	8.0	0.50	0.03	0.21
SMD1210-175-6V	6	100	1.75	3.50	0.8	8.0	0.60	0.02	0.08
SMD1210-200-6V	6	100	2.00	4.00	0.8	8.0	1.00	0.015	0.07

Electrical Characteristic

Model	Vmax	I _{max}	I _{Hold}	I _{Trip}	Maximum Time to Trip		Resistance (Ω)	
	V (DC)	(A)	(A)	(A)	Current (A)	Time (S)	R _{min}	R _{max}
SMD1206-005-60V	60.0	100	0.05	0.15	0.25	1.50	3.600	50.000
SMD1206-010-60V	60.0	100	0.10	0.25	0.5	1.00	1.600	15.000
SMD1206-010-33V	33.0	100	0.10	0.25	0.5	1.00	1.600	15.000
SMD1206-012-30V	30	100	0.12	0.29	1.00	0.20	1.350	10.00
SMD1206-016-30V	30	100	0.16	0.37	1.00	0.30	1.000	4.50
SMD1206-020-24V	24.0	100	0.20	0.46	8.0	0.08	0.350	3.500
SMD1206-025-16V	16.0	100	0.25	0.50	8.0	0.08	0.350	2.500
SMD1206-030-16V	16.0	100	0.30	0.65	8.0	0.10	0.250	2.00
SMD1206-035-16V	16.0	100	0.35	0.75	8.0	0.10	0.250	1.300
SMD1206-050-6V	6.0	100	0.50	1.00	8.0	0.10	0.150	0.700
SMD1206-050-13.2	13.2	100	0.50	1.00	8.0	0.10	0.150	0.700
SMD1206-050-16V	16	100	0.50	1.00	8.0	0.10	0.150	0.750
SMD1206-050-24V	24	100	0.50	1.00	8.0	0.10	0.150	0.750
SMD1206-075-6V	6.0	100	0.75	1.50	8.0	0.20	0.090	0.500
SMD1206-075-13.2V	13.2	100	0.75	1.50	8.0	0.20	0.090	0.500
SMD1206-075-16V	16	100	0.75	1.50	8.0	0.20	0.090	0.500
SMD1206-100-6V	6.0	100	1.00	1.80	8.0	0.30	0.055	0.270
SMD1206-100-13.2V	13.2	100	1.00	1.80	8.0	0.30	0.055	0.270
SMD1206-100-16V	16	100	1.00	1.80	8.0	0.30	0.055	0.330
SMD1206-110-8V	8.0	100	1.10	1.80	8.0	0.30	0.050	0.230
SMD1206-150-6V	6.0	100	1.50	3.00	8.0	1.00	0.040	0.130
SMD1206-200-6V	6.0	100	2.00	3.50	8.0	1.0	0.018	0.080

PPTC SMD1210 Series

▲ Features:

- RoHS Compliant & Halogen Free
- Faster tripping, 1210 Dimension, Surface mountable, Solid state
- Maximum Voltage: 6~60Vdc
- Operating Current: 0.05A~2A,
- Operating Temperature: -40°C TO 85°C

Thermal Derating Chart-IH (A)

Model	Maximum ambient operating temperatures (°C)									
	-40	-20	0	25	40	50	60	70	85	
SMD1210-005-60V	0.08	0.07	0.06	0.05	0.04	0.04	0.03	0.03	0.02	
SMD1210-010-30V	0.16	0.14	0.12	0.10	0.08	0.07	0.06	0.05	0.05	
SMD1210-020-30V	0.29	0.26	0.22	0.20	0.16	0.14	0.13	0.11	0.08	
SMD1210-035-30V	0.47	0.45	0.40	0.35	0.33	0.28	0.24	0.21	0.18	
SMD1210-035-16V	0.47	0.45	0.40	0.35	0.33	0.28	0.24	0.21	0.18	
SMD1210-050-16V	0.76	0.67	0.58	0.50	0.43	0.40	0.36	0.32	0.28	
SMD1210-075-6V	1.00	0.97	0.86	0.75	0.64	0.59	0.54	0.48	0.40	
SMD1210-110-6V	1.60	1.42	1.26	1.10	0.94	0.86	0.80	0.70	0.58	
SMD1210-110-12V	1.60	1.42	1.26	1.10	0.94	0.86	0.80	0.70	0.58	
SMD1210-150-6V	2.30	2.02	1.76	1.50	1.24	1.11	1.00	0.85	0.65	
SMD1210-175-6V	2.45	2.22	2.01	1.75	1.45	1.26	1.10	0.98	0.80	
SMD1210-200-6V	2.60	2.44	2.35	2.00	1.78	1.67	1.50	1.45	1.10	

Electrical Characteristic

Model	Vmax	I _{max}	I _{Hold}	I _{Trip}	Pd Max	Maximum Time to Trip		Resistance (Ω)	
	V (DC)	(A)	(A)	(A)	W	Current (A)	Time (S)	R _{min}	R _{max}
SMD1210-005-60V	60	100	0.05	0.15	0.6	0.25	1.50	2.8	50
SMD1210-010-30V	30	100	0.10	0.30	0.6	0.50	0.60	0.8	15
SMD1210-020-30V	30	100	0.20	0.40	0.6	8.0	0.02	0.40	5
SMD1210-035-30V	30	100	0.35	0.75	0.6	8.0	0.20	0.20	1.3
SMD1210-035-16V	16	100	0.35	0.75	0.6	8.0	0.20	0.20	1.3
SMD1210-050-16V	16	100	0.50	1.00	0.6	8.0	0.10	0.18	0.9
SMD1210-075-6V	6	100	0.75	1.50	0.6	8.0	0.10	0.07	0.4
SMD1210-110-6V	6	100	1.10	2.20	0.6	8.0	0.30	0.05	0.21
SMD1210-110-12V	12	100	1.10	2.20	0.8	8.0	0.30	0.05	0.25
SMD1210-150-6V	6	100	1.50	3.00	0.8	8.0	0.50	0.03	0.21
SMD1210-175-6V	6	100	1.75	3.50	0.8	8.0	0.60	0.02	0.08
SMD1210-200-6V	6	100	2.00	4.00	0.8	8.0	1.00	0.015	0.07

PPTC SMD1812 Series

▲ Features:

- RoHS Compliant & Halogen Free
- Faster tripping, 1812 Dimension, Surface mountable, Solid state
- Maximum Voltage: 6~60Vdc
- Operating Current: 0.1A~3.5A,
- Operating Temperature: -40°C TO 85°C

Thermal Derating Chart-IH (A)

Model	Maximum ambient operating temperatures (°C)								
	-40	-20	0	25	40	50	60	70	85
SMD1812-010	0.16	0.14	0.12	0.10	0.08	0.07	0.06	0.05	0.03
SMD1812-014	0.23	0.19	0.17	0.14	0.12	0.10	0.09	0.08	0.06
SMD1812-020	0.29	0.26	0.23	0.20	0.17	0.15	0.14	0.12	0.10
SMD1812-030	0.44	0.39	0.35	0.30	0.26	0.23	0.21	0.18	0.15
SMD1812-050	0.59	0.57	0.55	0.50	0.45	0.43	0.35	0.30	0.23
SMD1812-075	1.10	0.99	0.87	0.75	0.63	0.57	0.49	0.45	0.35
SMD1812-110	1.60	1.45	1.28	1.10	0.92	0.83	0.71	0.66	0.52
SMD1812-125	2.00	1.75	1.52	1.25	1.00	0.95	0.90	0.75	0.53
SMD1812-150	2.30	2.05	1.77	1.50	1.23	1.09	0.95	0.82	0.61
SMD1812-160	2.45	2.15	1.89	1.60	1.34	1.25	1.15	0.96	0.79
SMD1812-200	2.89	2.61	2.30	2.00	1.75	1.66	1.45	1.39	1.19
SMD1812-260	3.76	3.39	2.99	2.60	2.28	2.16	1.89	1.81	1.55
SMD1812-300	4.34	3.92	3.45	3.00	2.63	2.49	2.18	2.09	1.79

Electrical Characteristic

Model	Vmax	I _{max}	I _{Hold}	I _{Trip}	Maximum Time to Trip		Resistance (Ω)	
	V (DC)	(A)	(A)	(A)	Current (A)	Time (S)	R _{min}	R _{max}
SMD1812-010-30V	30.0	100	0.10	0.30	0.5	1.50	0.750	15.000
SMD1812-010-60V	60.0	100	0.10	0.30	0.5	1.50	0.750	15.000
SMD1812-014-33V	33.0	100	0.14	0.34	1.5	0.15	0.650	6.000
SMD1812-014-60V	60.0	100	0.14	0.34	1.5	0.15	0.650	6.000
SMD1812-020-30V	30.0	100	0.20	0.40	8.0	0.02	0.350	5.000
SMD1812-030-30V	30.0	100	0.30	0.60	8.0	0.10	0.250	3.000
SMD1812-050-15V	15.0	100	0.50	1.00	8.0	0.15	0.150	1.000
SMD1812-050-24V	24.0	100	0.50	1.00	8.0	0.15	0.150	1.000
SMD1812-050-30V	30.0	100	0.50	1.00	8.0	0.15	0.150	1.000
SMD1812-075-13.2V	13.2	100	0.75	1.50	8.0	0.20	0.090	0.450
SMD1812-075-24V	24	100	0.75	1.50	8.0	0.20	0.090	0.450
SMD1812-075-33V	33	100	0.75	1.50	8.0	0.20	0.090	0.450
SMD1812-110-16V	16.0	100	1.10	2.20	8.0	0.30	0.050	0.250
SMD1812-110-8V	8.0	100	1.10	2.20	8.0	0.30	0.050	0.250
SMD1812-110-24V	24.0	100	1.10	2.20	8.0	0.30	0.050	0.250
SMD1812-110-33V	33.0	100	1.10	2.20	8.0	0.30	0.050	0.250
SMD1812-125-8V	8.0	100	1.25	2.50	8.0	0.40	0.050	0.200
SMD1812-125-16V	16.0	100	1.25	2.50	8.0	0.40	0.050	0.200
SMD1812-150-8V	8.0	100	1.50	3.00	8.0	0.50	0.040	0.160
SMD1812-150-16V	16.0	100	1.50	3.00	8.0	0.50	0.040	0.160
SMD1812-150-24V	24.0	100	1.50	3.00	8.0	0.50	0.040	0.160
SMD1812-160-8V	8.0	100	1.60	2.80	8.0	1.00	0.030	0.130
SMD1812-200-8V	8.0	100	2.00	4.00	8.0	2.00	0.020	0.100
SMD1812-200-12V	12.0	100	2.00	4.00	8.0	2.00	0.020	0.100
SMD1812-200-16V	16.0	100	2.00	4.00	8.0	2.00	0.020	0.100
SMD1812-260-8V	8.0	100	2.60	5.00	8.0	2.50	0.015	0.050
SMD1812-260-12V	12.0	100	2.60	5.00	8.0	2.50	0.015	0.060
SMD1812-260-16V	16.0	100	2.60	5.00	8.0	2.50	0.015	0.060
SMD1812-300-6V	6.0	100	3.00	5.00	8.0	4.00	0.012	0.040

PPTC SMD1812 Series

▲ Features:

- RoHS Compliant & Halogen Free
- Faster tripping, 1812 Dimension, Surface mountable, Solid state
- Maximum Voltage: 6~60Vdc
- Operating Current: 0.1A~3.5A,
- Operating Temperature: -40°C TO 85°C

Thermal Derating Chart-IH (A)

Model	Maximum ambient operating temperatures (°C)								
	-40	-20	0	25	40	50	60	70	85
SMD1812-010	0.16	0.14	0.12	0.10	0.08	0.07	0.06	0.05	0.03
SMD1812-014	0.23	0.19	0.17	0.14	0.12	0.10	0.09	0.08	0.06
SMD1812-020	0.29	0.26	0.23	0.20	0.17	0.15	0.14	0.12	0.10
SMD1812-030	0.44	0.39	0.35	0.30	0.26	0.23	0.21	0.18	0.15
SMD1812-050	0.59	0.57	0.55	0.50	0.45	0.43	0.35	0.30	0.23
SMD1812-075	1.10	0.99	0.87	0.75	0.63	0.57	0.49	0.45	0.35
SMD1812-110	1.60	1.45	1.28	1.10	0.92	0.83	0.71	0.66	0.52
SMD1812-125	2.00	1.75	1.52	1.25	1.00	0.95	0.90	0.75	0.53
SMD1812-150	2.30	2.05	1.77	1.50	1.23	1.09	0.95	0.82	0.61
SMD1812-160	2.45	2.15	1.89	1.60	1.34	1.25	1.15	0.96	0.79
SMD1812-200	2.89	2.61	2.30	2.00	1.75	1.66	1.45	1.39	1.19
SMD1812-260	3.76	3.39	2.99	2.60	2.28	2.16	1.89	1.81	1.55
SMD1812-300	4.34	3.92	3.45	3.00	2.63	2.49	2.18	2.09	1.79

Electrical Characteristic

Model	Vmax	I _{max}	I _{Hold}	I _{Trip}	Maximum Time to Trip		Resistance (Ω)	
	V (DC)	(A)	(A)	(A)	Current (A)	Time (S)	R _{min}	R _{max}
SMD1812-010-30V	30.0	100	0.10	0.30	0.5	1.50	0.750	15.000
SMD1812-010-60V	60.0	100	0.10	0.30	0.5	1.50	0.750	15.000
SMD1812-014-33V	33.0	100	0.14	0.34	1.5	0.15	0.650	6.000
SMD1812-014-60V	60.0	100	0.14	0.34	1.5	0.15	0.650	6.000
SMD1812-020-30V	30.0	100	0.20	0.40	8.0	0.02	0.350	5.000
SMD1812-030-30V	30.0	100	0.30	0.60	8.0	0.10	0.250	3.000
SMD1812-050-15V	15.0	100	0.50	1.00	8.0	0.15	0.150	1.000
SMD1812-050-24V	24.0	100	0.50	1.00	8.0	0.15	0.150	1.000
SMD1812-050-30V	30.0	100	0.50	1.00	8.0	0.15	0.150	1.000
SMD1812-075-13.2V	13.2	100	0.75	1.50	8.0	0.20	0.090	0.450
SMD1812-075-24V	24	100	0.75	1.50	8.0	0.20	0.090	0.450
SMD1812-075-33V	33	100	0.75	1.50	8.0	0.20	0.090	0.450
SMD1812-110-16V	16.0	100	1.10	2.20	8.0	0.30	0.050	0.250
SMD1812-110-8V	8.0	100	1.10	2.20	8.0	0.30	0.050	0.250
SMD1812-110-24V	24.0	100	1.10	2.20	8.0	0.30	0.050	0.250
SMD1812-110-33V	33.0	100	1.10	2.20	8.0	0.30	0.050	0.250
SMD1812-125-8V	8.0	100	1.25	2.50	8.0	0.40	0.050	0.200
SMD1812-125-16V	16.0	100	1.25	2.50	8.0	0.40	0.050	0.200
SMD1812-150-8V	8.0	100	1.50	3.00	8.0	0.50	0.040	0.160
SMD1812-150-16V	16.0	100	1.50	3.00	8.0	0.50	0.040	0.160
SMD1812-150-24V	24.0	100	1.50	3.00	8.0	0.50	0.040	0.160
SMD1812-160-8V	8.0	100	1.60	2.80	8.0	1.00	0.030	0.130
SMD1812-200-8V	8.0	100	2.00	4.00	8.0	2.00	0.020	0.100
SMD1812-200-12V	12.0	100	2.00	4.00	8.0	2.00	0.020	0.100
SMD1812-200-16V	16.0	100	2.00	4.00	8.0	2.00	0.020	0.100
SMD1812-260-8V	8.0	100	2.60	5.00	8.0	2.50	0.015	0.050
SMD1812-260-12V	12.0	100	2.60	5.00	8.0	2.50	0.015	0.060
SMD1812-260-16V	16.0	100	2.60	5.00	8.0	2.50	0.015	0.060
SMD1812-300-6V	6.0	100	3.00	5.00	8.0	4.00	0.012	0.040

PPTC SMD2920 Series

▲ Features:

- RoHS Compliant & Halogen Free
- Faster tripping, 0603 Dimension, Surface mountable, Solid state
- Maximum Voltage: 6~30Vdc
- Operating Current: 0.35A~3.0A,
- Operating Temperature: -40°C TO 85°C

Thermal Derating Chart-IH (A)

Model	Maximum ambient operating temperatures (°C)								
	-40	-20	0	25	40	50	60	70	85
SMD2920-030-60V	0.44	0.37	0.35	0.30	0.28	0.23	0.20	0.18	0.18
SMD2920-050-60V	0.73	0.62	0.59	0.50	0.47	0.38	0.34	0.30	0.30
SMD2920-075-33V	1.09	0.92	0.88	0.75	0.70	0.56	0.50	0.45	0.45
SMD2920-100-33V	1.45	1.23	1.17	1.00	0.93	0.75	0.67	0.60	0.60
SMD2920-125-33V	1.81	1.54	1.46	1.25	1.16	0.94	0.84	0.75	0.75
SMD2920-150-33V	2.18	1.85	1.76	1.50	1.40	1.13	1.01	0.90	0.90
SMD2920-185-33V	2.68	2.28	2.16	1.85	1.72	1.39	1.24	1.11	1.11
SMD2920-200-16V	2.90	2.46	2.34	2.00	1.86	1.50	1.34	1.20	1.20
SMD2920-200-24V	2.90	2.46	2.34	2.00	1.86	1.50	1.34	1.20	1.20
SMD2920-250-16V	3.63	3.08	2.93	2.50	2.33	1.88	1.68	1.50	1.50
SMD2920-260-16V	3.77	3.20	3.04	2.60	2.42	1.95	1.74	1.56	1.56
SMD2920-300-6V	4.35	3.69	3.51	3.00	2.79	2.25	2.01	1.80	1.80
SMD2920-300-16V	4.35	3.69	3.51	3.00	2.79	2.25	2.01	1.80	1.80

Electrical Characteristic

Model	Vmax	I _{max}	I _{Hold}	I _{Trip}	P _{dmax}	Maximum Time to Trip		Resistance (Ω)	
	V (DC)	(A)	(A)	(A)	(W)	Current (A)	Time (S)	R _{min}	R _{max}
SMD2920-030-60V	60	100	0.30	0.60	1.5	1.5	3.0	0.60	4.80
SMD2920-050-60V	60	100	0.50	1.00	1.5	2.5	4.0	0.18	1.40
SMD2920-075-33V	33	100	0.75	1.50	1.5	8.0	0.3	0.10	1.00
SMD2920-100-33V	33	100	1.00	2.20	1.5	8.0	0.5	0.065	0.41
SMD2920-125-33V	33	100	1.25	2.50	1.5	8.0	2.0	0.05	0.25
SMD2920-150-33V	33	100	1.50	3.00	1.5	8.0	2.0	0.035	0.23
SMD2920-185-33V	33	100	1.85	3.70	1.5	8.0	2.5	0.030	0.15
SMD2920-200-16V	16	100	2.00	4.00	1.5	8.0	4.5	0.020	0.12
SMD2920-200-24V	24	100	2.00	4.00	1.5	8.0	4.5	0.020	0.12
SMD2920-250-16V	16	100	2.50	5.00	1.5	8.0	16.0	0.020	0.085
SMD2920-260-16V	16	100	2.60	5.20	1.5	8.0	10.0	0.014	0.075
SMD2920-300-6V	6	100	3.00	6.00	1.5	8.0	20.0	0.012	0.048
SMD2920-300-16V	16	100	3.00	6.00	1.5	8.0	20.0	0.012	0.050

PPTC SMD2920 Series

▲ Features:

- RoHS Compliant & Halogen Free
- Faster tripping, 0603 Dimension, Surface mountable, Solid state
- Maximum Voltage: 6~30Vdc
- Operating Current: 0.35A~3.0A,
- Operating Temperature: -40°C TO 85°C

Thermal Derating Chart-IH (A)

Model	Maximum ambient operating temperatures (°C)								
	-40	-20	0	25	40	50	60	70	85
SMD2920-030-60V	0.44	0.37	0.35	0.30	0.28	0.23	0.20	0.18	0.18
SMD2920-050-60V	0.73	0.62	0.59	0.50	0.47	0.38	0.34	0.30	0.30
SMD2920-075-33V	1.09	0.92	0.88	0.75	0.70	0.56	0.50	0.45	0.45
SMD2920-100-33V	1.45	1.23	1.17	1.00	0.93	0.75	0.67	0.60	0.60
SMD2920-125-33V	1.81	1.54	1.46	1.25	1.16	0.94	0.84	0.75	0.75
SMD2920-150-33V	2.18	1.85	1.76	1.50	1.40	1.13	1.01	0.90	0.90
SMD2920-185-33V	2.68	2.28	2.16	1.85	1.72	1.39	1.24	1.11	1.11
SMD2920-200-16V	2.90	2.46	2.34	2.00	1.86	1.50	1.34	1.20	1.20
SMD2920-200-24V	2.90	2.46	2.34	2.00	1.86	1.50	1.34	1.20	1.20
SMD2920-250-16V	3.63	3.08	2.93	2.50	2.33	1.88	1.68	1.50	1.50
SMD2920-260-16V	3.77	3.20	3.04	2.60	2.42	1.95	1.74	1.56	1.56
SMD2920-300-6V	4.35	3.69	3.51	3.00	2.79	2.25	2.01	1.80	1.80
SMD2920-300-16V	4.35	3.69	3.51	3.00	2.79	2.25	2.01	1.80	1.80

Electrical Characteristic

Model	Vmax	I _{max}	I _{Hold}	I _{Trip}	P _{dmax}	Maximum Time to Trip		Resistance (Ω)	
	V (DC)	(A)	(A)	(A)	(W)	Current (A)	Time (S)	R _{min}	R _{max}
SMD2920-030-60V	60	100	0.30	0.60	1.5	1.5	3.0	0.60	4.80
SMD2920-050-60V	60	100	0.50	1.00	1.5	2.5	4.0	0.18	1.40
SMD2920-075-33V	33	100	0.75	1.50	1.5	8.0	0.3	0.10	1.00
SMD2920-100-33V	33	100	1.00	2.20	1.5	8.0	0.5	0.065	0.41
SMD2920-125-33V	33	100	1.25	2.50	1.5	8.0	2.0	0.05	0.25
SMD2920-150-33V	33	100	1.50	3.00	1.5	8.0	2.0	0.035	0.23
SMD2920-185-33V	33	100	1.85	3.70	1.5	8.0	2.5	0.030	0.15
SMD2920-200-16V	16	100	2.00	4.00	1.5	8.0	4.5	0.020	0.12
SMD2920-200-24V	24	100	2.00	4.00	1.5	8.0	4.5	0.020	0.12
SMD2920-250-16V	16	100	2.50	5.00	1.5	8.0	16.0	0.020	0.085
SMD2920-260-16V	16	100	2.60	5.20	1.5	8.0	10.0	0.014	0.075
SMD2920-300-6V	6	100	3.00	6.00	1.5	8.0	20.0	0.012	0.048
SMD2920-300-16V	16	100	3.00	6.00	1.5	8.0	20.0	0.012	0.050

Polymer PTC Resettable 16V Series

▲ Features:

RoHS Compliant & Halogen Free

Radial leaded Devices

Cured, flame retardant epoxy polymer insulating material meets UL94V-0 requirements

Operation Current: 0.1A~14A, Maximum Voltage: 16Vdc, Operating Temperature: -40°C TO 85°C

▲ Product Dimensions

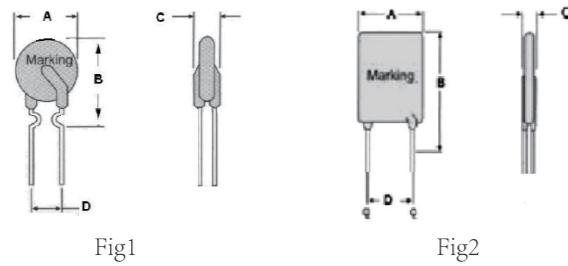

Unit : mm

Model	Dimensions (mm)				Lead material	Shape
	A(max)	B(max)	C(max)	D(typ)	Tinned matel(mm)	Fig
16V-010	5.5	12	3	5.1	24 AWG/Φ0.5	1
16V-025	5.5	12	3	5.1	24 AWG/Φ0.5	1
16V-030	5.5	12	3	5.1	24 AWG/Φ0.5	1
16V-050	5.5	12	3	5.1	24 AWG/Φ0.5	1
16V-075	7.4	13.5	3	5.1	24 AWG/Φ0.5	1
16V-090	7.4	13.5	3	5.1	24 AWG/Φ0.5	1
16V-110	7.4	13.5	3	5.1	24 AWG/Φ0.5	1
16V-135	7.4	13.5	3	5.1	24 AWG/Φ0.5	1
16V-160	7.4	14	3	5.1	24 AWG/Φ0.5	1
16V-200	9	12	3	5.1	24 AWG/Φ0.5	2
16V-300	9	12	3	5.1	20 AWG/Φ0.8	2
16V-400	10	13	3	5.1	20 AWG/Φ0.8	2
16V-500	10	17.5	3	5.1	20 AWG/Φ0.8	2
16V-600	13.5	17.5	3	5.1	20 AWG/Φ0.8	2
16V-700	13.5	23	3	5.1	20 AWG/Φ0.8	2
16V-800	13.5	23	3	5.1	20 AWG/Φ0.8	2
16V-900	15	24	3	5.1	20 AWG/Φ0.8	2
16V-1000	18	26	3	5.1	20 AWG/Φ0.8	2
16V-1100	18	26	3	5.1	20 AWG/Φ0.8	2
16V-1200	22.5	26	3	10.2	20 AWG/Φ0.8	2
16V-1300	24	30	3	10.2	20 AWG/Φ0.8	2
16V-1400	24	30	3	10.2	20 AWG/Φ0.8	2

Note: ① Dimensions A, B, C is the maximum size, D values are typical tolerance of ± 0.50mm

Thermal Derating Chart-IH (A)

Model	Maximum ambient operating temperatures (°C)									
	-40	-20	0	25	40	50	60	70	80	85
16V-010	0.14	0.13	0.12	0.1	0.09	0.08	0.08	0.07	0.06	0.04
16V-025	0.37	0.33	0.3	0.25	0.24	0.22	0.2	0.17	0.15	0.11
16V-030	0.44	0.39	0.36	0.3	0.28	0.26	0.24	0.21	0.18	0.14
16V-050	0.74	0.66	0.6	0.5	0.48	0.44	0.4	0.35	0.3	0.23
16V-075	1.11	0.99	0.9	0.75	0.72	0.66	0.6	0.53	0.45	0.35
16V-090	1.33	1.18	1.08	0.9	0.86	0.79	0.72	0.63	0.54	0.42
16V-110	1.62	1.45	1.32	1.1	1.05	0.96	0.88	0.78	0.67	0.51
16V-135	1.99	1.78	1.62	1.35	1.29	1.18	1.08	0.95	0.82	0.63
16V-160	2.36	2.11	1.92	1.6	1.53	1.4	1.28	1.13	0.97	0.75
16V-200	2.96	2.64	2.4	2	1.92	1.76	1.6	1.42	1.22	0.94
16V-300	4.44	3.96	3.6	3	2.88	2.64	2.4	2.13	1.83	1.41
16V-400	5.92	5.28	4.8	4	3.84	3.52	3.2	2.84	2.44	1.88
16V-500	7.4	6.6	6	5	4.8	4.4	4	3.55	3.05	2.35
16V-600	8.88	7.92	7.2	6	5.76	5.28	4.8	4.26	3.66	2.82
16V-700	10.36	9.24	8.4	7	6.72	6.16	5.6	4.97	4.27	3.29
16V-800	11.84	10.56	9.6	8	7.68	7.04	6.4	5.68	4.88	3.76
16V-900	13.32	11.88	10.8	9	8.64	7.92	7.2	6.39	5.49	4.23
16V-1000	14.8	13.2	12	10	9.6	8.8	8	7.1	6.1	4.7
16V-1100	16.28	14.52	13.2	11	10.56	9.68	8.8	7.81	6.71	5.17
16V-1200	17.76	15.84	14.4	12	11.52	10.56	9.6	8.52	7.32	5.64
16V-1300	19.24	17.16	15.6	13	12.48	11.44	10.4	9.23	7.93	6.11
16V-1400	20.72	18.48	16.8	14	13.44	12.32	11.2	9.94	8.54	6.58

PPTC

Polymer PTC Resettable 16V Series

▲ Features:

RoHS Compliant & Halogen Free

Radial leaded Devices

Cured, flame retardant epoxy polymer insulating material meets UL94V-0 requirements

Operation Current: 0.1A~14A, Maximum Voltage: 16Vdc, Operating Temperature: -40°C TO 85°C

▲ Product Dimensions

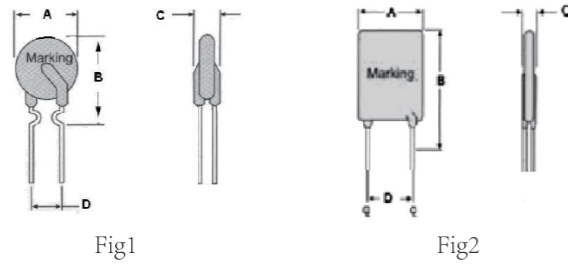

Unit : mm

Model	Dimensions (mm)				Lead material	Shape
	A(max)	B(max)	C(max)	D(typ)	Tinned matel(mm)	Fig
16V-010	5.5	12	3	5.1	24 AWG/Φ0.5	1
16V-025	5.5	12	3	5.1	24 AWG/Φ0.5	1
16V-030	5.5	12	3	5.1	24 AWG/Φ0.5	1
16V-050	5.5	12	3	5.1	24 AWG/Φ0.5	1
16V-075	7.4	13.5	3	5.1	24 AWG/Φ0.5	1
16V-090	7.4	13.5	3	5.1	24 AWG/Φ0.5	1
16V-110	7.4	13.5	3	5.1	24 AWG/Φ0.5	1
16V-135	7.4	13.5	3	5.1	24 AWG/Φ0.5	1
16V-160	7.4	14	3	5.1	24 AWG/Φ0.5	1
16V-200	9	12	3	5.1	24 AWG/Φ0.5	2
16V-300	9	12	3	5.1	20 AWG/Φ0.8	2
16V-400	10	13	3	5.1	20 AWG/Φ0.8	2
16V-500	10	17.5	3	5.1	20 AWG/Φ0.8	2
16V-600	13.5	17.5	3	5.1	20 AWG/Φ0.8	2
16V-700	13.5	23	3	5.1	20 AWG/Φ0.8	2
16V-800	13.5	23	3	5.1	20 AWG/Φ0.8	2
16V-900	15	24	3	5.1	20 AWG/Φ0.8	2
16V-1000	18	26	3	5.1	20 AWG/Φ0.8	2
16V-1100	18	26	3	5.1	20 AWG/Φ0.8	2
16V-1200	22.5	26	3	10.2	20 AWG/Φ0.8	2
16V-1300	24	30	3	10.2	20 AWG/Φ0.8	2
16V-1400	24	30	3	10.2	20 AWG/Φ0.8	2

Note: ① Dimensions A, B, C is the maximum size, D values are typical tolerance of ± 0.50mm

Thermal Derating Chart-IH (A)

Model	Maximum ambient operating temperatures (°C)									
	-40	-20	0	25	40	50	60	70	80	85
16V-010	0.14	0.13	0.12	0.1	0.09	0.08	0.08	0.07	0.06	0.04
16V-025	0.37	0.33	0.3	0.25	0.24	0.22	0.2	0.17	0.15	0.11
16V-030	0.44	0.39	0.36	0.3	0.28	0.26	0.24	0.21	0.18	0.14
16V-050	0.74	0.66	0.6	0.5	0.48	0.44	0.4	0.35	0.3	0.23
16V-075	1.11	0.99	0.9	0.75	0.72	0.66	0.6	0.53	0.45	0.35
16V-090	1.33	1.18	1.08	0.9	0.86	0.79	0.72	0.63	0.54	0.42
16V-110	1.62	1.45	1.32	1.1	1.05	0.96	0.88	0.78	0.67	0.51
16V-135	1.99	1.78	1.62	1.35	1.29	1.18	1.08	0.95	0.82	0.63
16V-160	2.36	2.11	1.92	1.6	1.53	1.4	1.28	1.13	0.97	0.75
16V-200	2.96	2.64	2.4	2	1.92	1.76	1.6	1.42	1.22	0.94
16V-300	4.44	3.96	3.6	3	2.88	2.64	2.4	2.13	1.83	1.41
16V-400	5.92	5.28	4.8	4	3.84	3.52	3.2	2.84	2.44	1.88
16V-500	7.4	6.6	6	5	4.8	4.4	4	3.55	3.05	2.35
16V-600	8.88	7.92	7.2	6	5.76	5.28	4.8	4.26	3.66	2.82
16V-700	10.36	9.24	8.4	7	6.72	6.16	5.6	4.97	4.27	3.29
16V-800	11.84	10.56	9.6	8	7.68	7.04	6.4	5.68	4.88	3.76
16V-900	13.32	11.88	10.8	9	8.64	7.92	7.2	6.39	5.49	4.23
16V-1000	14.8	13.2	12	10	9.6	8.8	8	7.1	6.1	4.7
16V-1100	16.28	14.52	13.2	11	10.56	9.68	8.8	7.81	6.71	5.17
16V-1200	17.76	15.84	14.4	12	11.52	10.56	9.6	8.52	7.32	5.64
16V-1300	19.24	17.16	15.6	13	12.48	11.44	10.4	9.23	7.93	6.11
16V-1400	20.72	18.48	16.8	14	13.44	12.32	11.2	9.94	8.54	6.58

PPTC

Electrical Characteristic

Model	IHold	ITrip	Vmax	Imax	Pd Max	Maximum Time to Trip		Nominal resistance (mΩ)	
	(A)	(A)	V (DC)	A	W	Current (A)	Time (S)	Rmin	Rmax
16V-010	0.1	0.3	16	100	0.38	0.5	5	1500	7500
16V-025	0.25	0.5	16	100	0.45	1.25	5	500	1950
16V-030	0.3	0.6	16	100	0.49	1.5	5	300	700
16V-050	0.5	1	16	100	0.56	2.5	5	200	500
16V-075	0.75	1.5	16	100	0.72	3.75	5	100	260
16V-090	0.9	1.8	16	100	0.83	4.5	5	90	180
16V-110	1.1	2.2	16	100	0.94	5.5	5	60	150
16V-135	1.35	2.7	16	100	1.2	6.75	5	40	130
16V-160	1.6	3.2	16	100	1.4	8	5	40	110
16V-200	2	4	16	100	2.2	6	15	35	75
16V-300	3	6	16	100	2.3	9	15	20	60
16V-400	4	8	16	100	2.4	12	15	20	40
16V-500	5	10	16	100	2.6	15	15	14	25
16V-600	6	12	16	100	2.8	18	15	10	21
16V-700	7	14	16	100	3	21	15	8	15
16V-800	8	16	16	100	3	24	15	6	13
16V-900	9	18	16	100	3.3	27	25	4	12
16V-1000	10	20	16	100	3.7	30	30	4	11
16V-1100	11	22	16	100	3.7	33	30	3	9
16V-1200	12	24	16	100	4.2	36	30	3	8
16V-1300	13	26	16	100	4.2	39	50	3	8
16V-1400	14	28	16	100	4.2	40	50	3	7

Polymer PTC Resettable 30V Series

▲ Features:

- RoHS Compliant & Halogen Free
- Radial leaded Devices
- Cured, flame retardant epoxy polymer insulating material meets UL94V-0 requirements
- Operation Current: 0.5A~9A, Maximum Voltage: 30Vdc, Operating Temperature: -40°C TO 85°C

▲ Product Dimensions

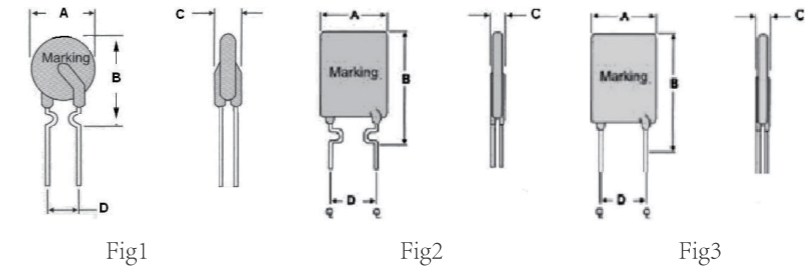

Unit : mm

Model	Dimensions (mm)				Lead material	Shape
	A(max)	B(max)	C(max)	D(typ)	Tinned matel(mm)	Fig
30V-050	7.4	12.7	3	5.1	24AWG/φ0.5	1
30V-075	7.4	13	3	5.1	24AWG/φ0.5	1
30V-090	7.4	18.5	3	5.1	24AWG/φ0.5	2
30V-110	7.4	18.5	3	5.1	24AWG/φ0.5	2
30V-120	7.4	18.5	3	5.1	24AWG/φ0.5	2
30V-135	9.2	17.6	3	5.1	24AWG/φ0.5	2
30V-160	9.2	20.2	3	5.1	24AWG/φ0.5	2
30V-185	9.2	20.2	3	5.1	24AWG/φ0.5	2
30V-200	15.2	20.2	3	5.1	24AWG/φ0.5	2
30V-250	13.2	22.4	3	5.1	24AWG/φ0.5	2
30V-300	13.2	20.4	3	5.1	20 AWG/φ0.8	3
30V-400	14	23.7	3	5.1	20 AWG/φ0.8	3
30V-500	14	23.7	3	10.2	20 AWG/φ0.8	3
30V-600	17.2	27	3	10.2	20 AWG/φ0.8	3
30V-700	17.2	27	3	10.2	20 AWG/φ0.8	3
30V-800	23.5	29.2	3	10.2	20 AWG/φ0.8	3
30V-900	23.5	29.2	3	10.2	20 AWG/φ0.8	3

Note: ① Dimensions A, B, C is the maximum size, D values are typical tolerance of ± 0.50mm

Electrical Characteristic

Model	I _{Hold}	I _{Trip}	V _{max}	I _{max}	P _d Max	Maximum Time to Trip		Nominal resistance (mΩ)	
	(A)	(A)	V (DC)	A	W	Current (A)	Time (S)	R _{min}	R _{max}
16V-010	0.1	0.3	16	100	0.38	0.5	5	1500	7500
16V-025	0.25	0.5	16	100	0.45	1.25	5	500	1950
16V-030	0.3	0.6	16	100	0.49	1.5	5	300	700
16V-050	0.5	1	16	100	0.56	2.5	5	200	500
16V-075	0.75	1.5	16	100	0.72	3.75	5	100	260
16V-090	0.9	1.8	16	100	0.83	4.5	5	90	180
16V-110	1.1	2.2	16	100	0.94	5.5	5	60	150
16V-135	1.35	2.7	16	100	1.2	6.75	5	40	130
16V-160	1.6	3.2	16	100	1.4	8	5	40	110
16V-200	2	4	16	100	2.2	6	15	35	75
16V-300	3	6	16	100	2.3	9	15	20	60
16V-400	4	8	16	100	2.4	12	15	20	40
16V-500	5	10	16	100	2.6	15	15	14	25
16V-600	6	12	16	100	2.8	18	15	10	21
16V-700	7	14	16	100	3	21	15	8	15
16V-800	8	16	16	100	3	24	15	6	13
16V-900	9	18	16	100	3.3	27	25	4	12
16V-1000	10	20	16	100	3.7	30	30	4	11
16V-1100	11	22	16	100	3.7	33	30	3	9
16V-1200	12	24	16	100	4.2	36	30	3	8
16V-1300	13	26	16	100	4.2	39	50	3	8
16V-1400	14	28	16	100	4.2	40	50	3	7

Polymer PTC Resettable 30V Series

▲ Features:

- RoHS Compliant & Halogen Free
- Radial leaded Devices
- Cured, flame retardant epoxy polymer insulating material meets UL94V-0 requirements
- Operation Current: 0.5A~9A, Maximum Voltage: 30Vdc, Operating Temperature: -40°C TO 85°C

▲ Product Dimensions

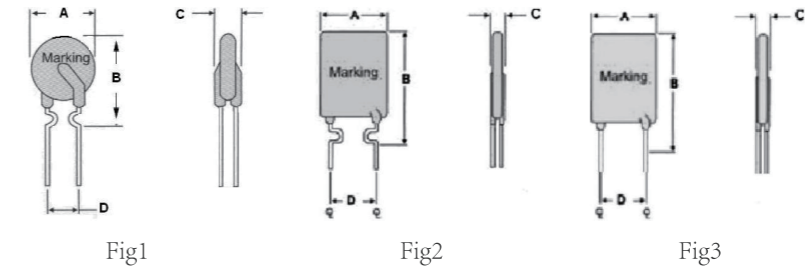

Unit : mm

Model	Dimensions (mm)				Lead material	Shape
	A(max)	B(max)	C(max)	D(typ)	Tinned matel(mm)	Fig
30V-050	7.4	12.7	3	5.1	24AWG/φ0.5	1
30V-075	7.4	13	3	5.1	24AWG/φ0.5	1
30V-090	7.4	18.5	3	5.1	24AWG/φ0.5	2
30V-110	7.4	18.5	3	5.1	24AWG/φ0.5	2
30V-120	7.4	18.5	3	5.1	24AWG/φ0.5	2
30V-135	9.2	17.6	3	5.1	24AWG/φ0.5	2
30V-160	9.2	20.2	3	5.1	24AWG/φ0.5	2
30V-185	9.2	20.2	3	5.1	24AWG/φ0.5	2
30V-200	15.2	20.2	3	5.1	24AWG/φ0.5	2
30V-250	13.2	22.4	3	5.1	24AWG/φ0.5	2
30V-300	13.2	20.4	3	5.1	20 AWG/φ0.8	3
30V-400	14	23.7	3	5.1	20 AWG/φ0.8	3
30V-500	14	23.7	3	10.2	20 AWG/φ0.8	3
30V-600	17.2	27	3	10.2	20 AWG/φ0.8	3
30V-700	17.2	27	3	10.2	20 AWG/φ0.8	3
30V-800	23.5	29.2	3	10.2	20 AWG/φ0.8	3
30V-900	23.5	29.2	3	10.2	20 AWG/φ0.8	3

Note: ① Dimensions A, B, C is the maximum size, D values are typical tolerance of ± 0.50mm

Thermal Derating Chart-IH (A)

Model	Maximum ambient operating temperatures (°C)									
	-40	-20	0	25	40	50	60	70	80	85
30V-050	0.72	0.65	0.57	0.5	0.45	0.41	0.38	0.34	0.3	0.25
30V-075	1.08	0.97	0.86	0.75	0.68	0.62	0.57	0.51	0.45	0.37
30V-090	1.3	1.17	1.03	0.9	0.81	0.74	0.69	0.61	0.54	0.45
30V-110	1.59	1.43	1.26	1.1	1	0.91	0.84	0.74	0.67	0.55
30V-120	1.74	1.56	1.38	1.2	1.09	0.99	0.92	0.81	0.73	0.6
30V-135	1.95	1.75	1.55	1.35	1.22	1.12	1.03	0.91	0.82	0.67
30V-160	2.32	2.08	1.84	1.6	1.45	1.32	1.23	1.08	0.97	0.8
30V-185	2.68	2.4	2.12	1.85	1.68	1.53	1.42	1.25	1.12	0.92
30V-200	2.9	2.6	2.3	2	1.82	1.66	1.54	1.36	1.22	1
30V-250	3.62	3.25	2.87	2.5	2.27	2.07	1.92	1.7	1.52	1.25
30V-300	4.35	3.9	3.45	3	2.73	2.49	2.31	2.04	1.83	1.5
30V-400	5.8	5.2	4.6	4	3.64	3.32	3.08	2.72	2.44	2
30V-500	7.25	6.5	5.75	5	4.55	4.15	3.85	3.4	3.05	2.5
30V-600	8.7	7.8	6.9	6	5.46	4.98	4.62	4.08	3.66	3
30V-700	10.15	9.1	8.05	7	6.37	5.81	5.39	4.76	4.27	3.5
30V-800	11.6	10.4	9.2	8	7.28	6.64	6.16	5.44	4.88	4
30V-900	13.05	11.7	10.35	9	8.19	7.47	6.93	6.12	5.49	4.5

Electrical Characteristic

Model	I _{Hold}	I _{Trip}	V _{max}	I _{max}	P _d Max	Maximum Time to Trip		Nominal resistance (mΩ)	
	(A)	(A)	V (DC)	A	W	Current (A)	Time (S)	R _{min}	R _{max}
30V-050	0.5	1	30	40	0.5	2.5	5	250	600
30V-075	0.75	1.5	30	40	0.6	3.75	5	200	370
30V-090	0.9	1.8	30	40	0.7	4.5	8	100	220
30V-110	1.1	2.2	30	40	0.7	5.5	8	70	200
30V-120	1.2	2.4	30	40	0.8	6	8	80	180
30V-135	1.35	1.7	30	40	0.8	6.75	8	70	160
30V-160	1.6	3.2	30	40	0.9	8	8	60	140
30V-185	1.85	3.7	30	40	1	9.25	8	50	120
30V-200	2	4	30	40	1.2	10	11	40	100
30V-250	2.5	5	30	40	1.2	12.5	11	30	80
30V-300	3	6	30	40	2	15	11	30	70
30V-400	4	8	30	40	2.5	20	12.7	10	60
30V-500	5	10	30	40	3	25	14.5	10	50
30V-600	6	12	30	40	3.5	30	16	5	40
30V-700	7	14	30	40	3.8	35	17.5	5	30
30V-800	8	16	30	40	4	40	18.8	5	25
30V-900	9	18	30	40	4.2	40	20	5	20

Thermal Derating Chart-IH (A)

Model	Maximum ambient operating temperatures (°C)									
	-40	-20	0	25	40	50	60	70	80	85
30V-050	0.72	0.65	0.57	0.5	0.45	0.41	0.38	0.34	0.3	0.25
30V-075	1.08	0.97	0.86	0.75	0.68	0.62	0.57	0.51	0.45	0.37
30V-090	1.3	1.17	1.03	0.9	0.81	0.74	0.69	0.61	0.54	0.45
30V-110	1.59	1.43	1.26	1.1	1	0.91	0.84	0.74	0.67	0.55
30V-120	1.74	1.56	1.38	1.2	1.09	0.99	0.92	0.81	0.73	0.6
30V-135	1.95	1.75	1.55	1.35	1.22	1.12	1.03	0.91	0.82	0.67
30V-160	2.32	2.08	1.84	1.6	1.45	1.32	1.23	1.08	0.97	0.8
30V-185	2.68	2.4	2.12	1.85	1.68	1.53	1.42	1.25	1.12	0.92
30V-200	2.9	2.6	2.3	2	1.82	1.66	1.54	1.36	1.22	1
30V-250	3.62	3.25	2.87	2.5	2.27	2.07	1.92	1.7	1.52	1.25
30V-300	4.35	3.9	3.45	3	2.73	2.49	2.31	2.04	1.83	1.5
30V-400	5.8	5.2	4.6	4	3.64	3.32	3.08	2.72	2.44	2
30V-500	7.25	6.5	5.75	5	4.55	4.15	3.85	3.4	3.05	2.5
30V-600	8.7	7.8	6.9	6	5.46	4.98	4.62	4.08	3.66	3
30V-700	10.15	9.1	8.05	7	6.37	5.81	5.39	4.76	4.27	3.5
30V-800	11.6	10.4	9.2	8	7.28	6.64	6.16	5.44	4.88	4
30V-900	13.05	11.7	10.35	9	8.19	7.47	6.93	6.12	5.49	4.5

Electrical Characteristic

Model	I _{Hold}	I _{Trip}	V _{max}	I _{max}	P _d Max	Maximum Time to Trip		Nominal resistance (mΩ)	
	(A)	(A)	V (DC)	A	W	Current (A)	Time (S)	R _{min}	R _{max}
30V-050	0.5	1	30	40	0.5	2.5	5	250	600
30V-075	0.75	1.5	30	40	0.6	3.75	5	200	370
30V-090	0.9	1.8	30	40	0.7	4.5	8	100	220
30V-110	1.1	2.2	30	40	0.7	5.5	8	70	200
30V-120	1.2	2.4	30	40	0.8	6	8	80	180
30V-135	1.35	1.7	30	40	0.8	6.75	8	70	160
30V-160	1.6	3.2	30	40	0.9	8	8	60	140
30V-185	1.85	3.7	30	40	1	9.25	8	50	120
30V-200	2	4	30	40	1.2	10	11	40	100
30V-250	2.5	5	30	40	1.2	12.5	11	30	80
30V-300	3	6	30	40	2	15	11	30	70
30V-400	4	8	30	40	2.5	20	12.7	10	60
30V-500	5	10	30	40	3	25	14.5	10	50
30V-600	6	12	30	40	3.5	30	16	5	40
30V-700	7	14	30	40	3.8	35	17.5	5	30
30V-800	8	16	30	40	4	40	18.8	5	25
30V-900	9	18	30	40	4.2	40	20	5	20

Polymer PTC Resettable 60V Series

▲ Features:

RoHS Compliant & Halogen Free

Radial leaded Devices

Cured, flame retardant epoxy polymer insulating material meets UL94V-0 requirements

Operation Current: 0.05A~5A, Maximum Voltage: 60Vdc, Operating Temperature: -40°C TO 85°C

▲ Product Dimensions

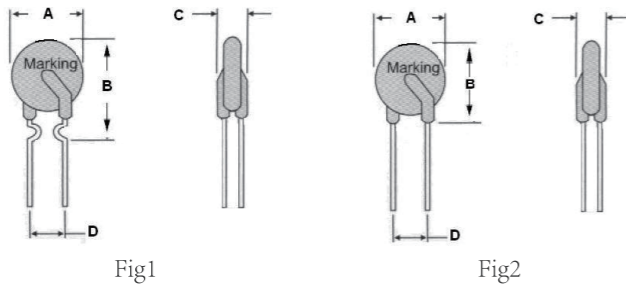

Unit : mm

Model	Dimensions (mm)				Lead material	Shape
	A(max)	B(max)	C(max)	D(typ)	Tinned matel(mm)	Fig
60V-005	5	8.5	3	5.1	24AWG/Φ0.5	1
60V-010	5.5	9.5	3	5.1	24AWG/Φ0.5	1
60V-017	7.4	12.7	3	5.1	24AWG/Φ0.5	1
60V-020	7.4	12.7	3	5.1	24AWG/Φ0.5	1
60V-025	7.4	12.7	3	5.1	24AWG/Φ0.5	1
60V-030	7.4	13	3	5.1	24AWG/Φ0.5	1
60V-040	7.8	16.2	3	5.1	24AWG/Φ0.5	1
60V-050	7.8	16.2	3	5.1	24AWG/Φ0.5	1
60V-065	9.7	17.8	3	5.1	22AWG/Φ0.6	1
60V-075	10.4	18.4	3	5.1	22AWG/Φ0.6	1
60V-090	11.7	18.4	3	5.1	22AWG/Φ0.6	1
60V-110	13	18	3	5.1	20 AWG/Φ0.8	2
60V-135	14.5	19.6	3	5.1	20 AWG/Φ0.8	2
60V-160	16.3	21.3	3	5.1	20 AWG/Φ0.8	2
60V-185	17.8	22.9	3	5.1	20 AWG/Φ0.8	2
60V-200	17.8	22.9	3	5.1	20 AWG/Φ0.8	2
60V-250	21.3	26.4	3	10.2	20 AWG/Φ0.8	2
60V-300	21.3	26.4	3	10.2	20 AWG/Φ0.8	2
60V-375	28.5	33.5	3	10.2	20 AWG/Φ0.8	2
60V-500	28.5	33.5	3	10.2	20 AWG/Φ0.8	2

Note: ① Dimensions A, B, C is the maximum size, D values are typical tolerance of ± 0.50mm

Thermal Derating Chart-IH (A)

Model	Maximum ambient operating temperatures (°C)									
	-40	-20	0	25	40	50	60	70	80	85
60V-005	0.08	0.07	0.06	0.05	0.04	0.04	0.03	0.03	0.02	0.02
60V-010	0.15	0.13	0.12	0.1	0.09	0.08	0.07	0.06	0.05	0.04
60V-017	0.25	0.23	0.2	0.17	0.15	0.13	0.12	0.1	0.09	0.06
60V-020	0.3	0.27	0.24	0.2	0.18	0.16	0.14	0.12	0.1	0.08
60V-025	0.37	0.34	0.3	0.25	0.22	0.2	0.18	0.15	0.13	0.1
60V-030	0.45	0.4	0.35	0.3	0.27	0.24	0.21	0.19	0.16	0.12
60V-040	0.6	0.54	0.47	0.4	0.36	0.32	0.28	0.25	0.21	0.16
60V-050	0.75	0.68	0.59	0.5	0.45	0.4	0.36	0.31	0.27	0.2
60V-065	0.97	0.88	0.77	0.65	0.58	0.52	0.46	0.41	0.35	0.26
60V-075	1.12	1.02	0.89	0.75	0.67	0.6	0.54	0.47	0.4	0.3
60V-090	1.35	1.22	1.07	0.9	0.81	0.73	0.64	0.56	0.48	0.36
60V-110	1.65	1.49	1.31	1.1	0.99	0.89	0.79	0.69	0.59	0.44
60V-135	2.02	1.83	1.6	1.35	1.21	1.09	0.97	0.85	0.72	0.54
60V-160	2.4	2.17	1.9	1.6	1.44	1.29	1.15	1	0.86	0.64
60V-185	2.77	2.51	2.2	1.85	1.66	1.49	1.33	1.16	1	0.74
60V-200	3	2.72	2.38	2	1.8	1.62	1.44	1.26	1.08	0.8
60V-250	3.75	3.4	2.97	2.5	2.25	2.02	1.8	1.57	1.35	1
60V-300	4.5	4.08	3.57	3	2.7	2.43	2.16	1.89	1.62	1.2
60V-375	5.62	5.1	4.46	3.75	3.37	3.03	2.7	2.36	2.02	1.5
60V-500	7.5	6.8	5.95	5	4.5	4.05	3.6	3.15	2.7	2

Polymer PTC Resettable 60V Series

▲ Features:

RoHS Compliant & Halogen Free

Radial leaded Devices

Cured, flame retardant epoxy polymer insulating material meets UL94V-0 requirements

Operation Current: 0.05A~5A, Maximum Voltage: 60Vdc, Operating Temperature: -40°C TO 85°C

▲ Product Dimensions

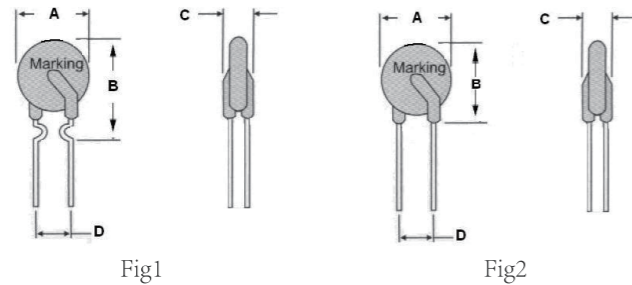

Unit : mm

Model	Dimensions (mm)				Lead material	Shape
	A(max)	B(max)	C(max)	D(typ)	Tinned matel(mm)	Fig
60V-005	5	8.5	3	5.1	24AWG/Φ0.5	1
60V-010	5.5	9.5	3	5.1	24AWG/Φ0.5	1
60V-017	7.4	12.7	3	5.1	24AWG/Φ0.5	1
60V-020	7.4	12.7	3	5.1	24AWG/Φ0.5	1
60V-025	7.4	12.7	3	5.1	24AWG/Φ0.5	1
60V-030	7.4	13	3	5.1	24AWG/Φ0.5	1
60V-040	7.8	16.2	3	5.1	24AWG/Φ0.5	1
60V-050	7.8	16.2	3	5.1	24AWG/Φ0.5	1
60V-065	9.7	17.8	3	5.1	22AWG/Φ0.6	1
60V-075	10.4	18.4	3	5.1	22AWG/Φ0.6	1
60V-090	11.7	18.4	3	5.1	22AWG/Φ0.6	1
60V-110	13	18	3	5.1	20 AWG/Φ0.8	2
60V-135	14.5	19.6	3	5.1	20 AWG/Φ0.8	2
60V-160	16.3	21.3	3	5.1	20 AWG/Φ0.8	2
60V-185	17.8	22.9	3	5.1	20 AWG/Φ0.8	2
60V-200	17.8	22.9	3	5.1	20 AWG/Φ0.8	2
60V-250	21.3	26.4	3	10.2	20 AWG/Φ0.8	2
60V-300	21.3	26.4	3	10.2	20 AWG/Φ0.8	2
60V-375	28.5	33.5	3	10.2	20 AWG/Φ0.8	2
60V-500	28.5	33.5	3	10.2	20 AWG/Φ0.8	2

Note: ① Dimensions A, B, C is the maximum size, D values are typical tolerance of ± 0.50mm

Thermal Derating Chart-IH (A)

Model	Maximum ambient operating temperatures (°C)									
	-40	-20	0	25	40	50	60	70	80	85
60V-005	0.08	0.07	0.06	0.05	0.04	0.04	0.03	0.03	0.02	0.02
60V-010	0.15	0.13	0.12	0.1	0.09	0.08	0.07	0.06	0.05	0.04
60V-017	0.25	0.23	0.2	0.17	0.15	0.13	0.12	0.1	0.09	0.06
60V-020	0.3	0.27	0.24	0.2	0.18	0.16	0.14	0.12	0.1	0.08
60V-025	0.37	0.34	0.3	0.25	0.22	0.2	0.18	0.15	0.13	0.1
60V-030	0.45	0.4	0.35	0.3	0.27	0.24	0.21	0.19	0.16	0.12
60V-040	0.6	0.54	0.47	0.4	0.36	0.32	0.28	0.25	0.21	0.16
60V-050	0.75	0.68	0.59	0.5	0.45	0.4	0.36	0.31	0.27	0.2
60V-065	0.97	0.88	0.77	0.65	0.58	0.52	0.46	0.41	0.35	0.26
60V-075	1.12	1.02	0.89	0.75	0.67	0.6	0.54	0.47	0.4	0.3
60V-090	1.35	1.22	1.07	0.9	0.81	0.73	0.64	0.56	0.48	0.36
60V-110	1.65	1.49	1.31	1.1	0.99	0.89	0.79	0.69	0.59	0.44
60V-135	2.02	1.83	1.6	1.35	1.21	1.09	0.97	0.85	0.72	0.54
60V-160	2.4	2.17	1.9	1.6	1.44	1.29	1.15	1	0.86	0.64
60V-185	2.77	2.51	2.2	1.85	1.66	1.49	1.33	1.16	1	0.74
60V-200	3	2.72	2.38	2	1.8	1.62	1.44	1.26	1.08	0.8
60V-250	3.75	3.4	2.97	2.5	2.25	2.02	1.8	1.57	1.35	1
60V-300	4.5	4.08	3.57	3	2.7	2.43	2.16	1.89	1.62	1.2
60V-375	5.62	5.1	4.46	3.75	3.37	3.03	2.7	2.36	2.02	1.5
60V-500	7.5	6.8	5.95	5	4.5	4.05	3.6	3.15	2.7	2

Electrical Characteristic

Model	I _{Hold}	I _{Trip}	V _{max}	I _{max}	P _d Max	Maximum Time to Trip		Nominal resistance (mΩ)	
	(A)	(A)	V (DC)	A	W	Current (A)	Time (S)	R _{min}	R _{max}
60V-005	0.05	0.15	60	40	0.26	0.25	8	7.3	20
60V-010	0.1	0.3	60	40	0.38	0.5	5	2.5	7.5
60V-017	0.17	0.34	60	40	0.48	0.85	5	2	5.21
60V-020	0.2	0.4	60	40	0.41	1	5	1.5	2.84
60V-025	0.25	0.5	60	40	0.45	1.25	5	1	1.95
60V-030	0.3	0.6	60	40	0.49	1.5	5	0.76	1.38
60V-040	0.4	0.8	60	40	0.56	2	5	0.45	0.88
60V-050	0.5	1	60	40	0.77	2.5	5	0.4	0.79
60V-065	0.65	1.3	60	40	0.88	3.25	5	0.31	0.5
60V-075	0.75	1.5	60	40	0.92	3.75	5	0.25	0.42
60V-090	0.9	1.8	60	40	0.99	4.5	5	0.2	0.33
60V-110	1.1	2.2	60	40	1.5	5.5	8	0.15	0.27
60V-135	1.35	2.7	60	40	1.7	6.75	8	0.12	0.21
60V-160	1.6	3.2	60	40	1.9	8	8	0.09	0.16
60V-185	1.85	3.7	60	40	2.1	9.25	8	0.08	0.14
60V-200	2	4	60	40	2.3	10	8	0.07	0.14
60V-250	2.5	5	60	40	2.5	12.5	8	0.05	0.1
60V-300	3	6	60	40	2.8	15	8	0.04	0.08
60V-375	3.75	7.5	60	40	3.2	18.75	24	0.03	0.06
60V-500	5	10	60	40	3.5	25	24	0.02	0.06

Polymer PTC Resettable 72V Series

▲ Features:

- RoHS Compliant & Halogen Free
- Radial leaded Devices
- Cured, flame retardant epoxy polymer insulating material meets UL94V-0 requirements
- Operation Current: 0.05A~3.75A
- Maximum Voltage: 72Vdc, Operating Temperature: -40°C TO 85°C

▲ Product Dimensions

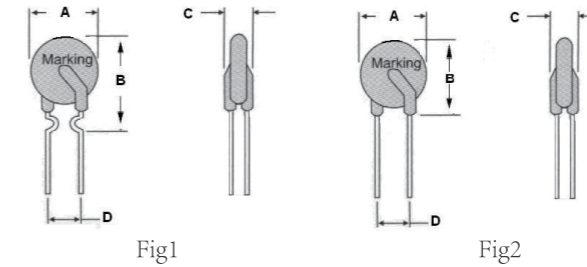

Unit : mm

Model	Dimensions (mm)				Lead material	Shape
	A(max)	B(max)	C(max)	D(typ)	Tinned matel(mm)	Fig
72V-005	5	8.5	3	5.1	24AWG/φ0.8	1
72V-010	5.5	9.5	3	5.1	24AWG/φ0.8	1
72V-017	7.4	12.7	3	5.1	24AWG/φ0.8	1
72V-020	7.4	12.7	3	5.1	24AWG/φ0.8	1
72V-025	7.4	12.7	3	5.1	24AWG/φ0.8	1
72V-030	7.4	13	3	5.1	24AWG/φ0.8	1
72V-040	7.8	16.2	3	5.1	24AWG/φ0.8	1
72V-050	7.8	16.2	3	5.1	24AWG/φ0.8	1
72V-065	9.7	17.8	3	5.1	24AWG/φ0.8	1
72V-075	10.4	18.4	3	5.1	24AWG/φ0.8	1
72V-090	11.7	18.4	3	5.1	24AWG/φ0.8	1
72V-110	13	18	3	5.1	24AWG/φ0.8	2
72V-135	14.5	19.6	3	5.1	24AWG/φ0.8	2
72V-160	16.3	21.3	3	5.1	24AWG/φ0.8	2
72V-185	17.8	22.9	3	5.1	24AWG/φ0.8	2
72V-200	17.8	22.9	3	5.1	24AWG/φ0.8	2
72V-250	21.3	26.4	3	10.2	24AWG/φ0.8	2
72V-300	21.3	26.4	3	10.2	24AWG/φ0.8	2
72V-375	28.5	33.5	3	10.2	24AWG/φ0.8	2

Note: ① Dimensions A, B, C is the maximum size, D values are typical tolerance of ± 0.50mm

Electrical Characteristic

Model	I _{Hold}	I _{Trip}	V _{max}	I _{max}	P _d Max	Maximum Time to Trip		Nominal resistance (mΩ)	
	(A)	(A)	V (DC)	A	W	Current (A)	Time (S)	R _{min}	R _{max}
60V-005	0.05	0.15	60	40	0.26	0.25	8	7.3	20
60V-010	0.1	0.3	60	40	0.38	0.5	5	2.5	7.5
60V-017	0.17	0.34	60	40	0.48	0.85	5	2	5.21
60V-020	0.2	0.4	60	40	0.41	1	5	1.5	2.84
60V-025	0.25	0.5	60	40	0.45	1.25	5	1	1.95
60V-030	0.3	0.6	60	40	0.49	1.5	5	0.76	1.38
60V-040	0.4	0.8	60	40	0.56	2	5	0.45	0.88
60V-050	0.5	1	60	40	0.77	2.5	5	0.4	0.79
60V-065	0.65	1.3	60	40	0.88	3.25	5	0.31	0.5
60V-075	0.75	1.5	60	40	0.92	3.75	5	0.25	0.42
60V-090	0.9	1.8	60	40	0.99	4.5	5	0.2	0.33
60V-110	1.1	2.2	60	40	1.5	5.5	8	0.15	0.27
60V-135	1.35	2.7	60	40	1.7	6.75	8	0.12	0.21
60V-160	1.6	3.2	60	40	1.9	8	8	0.09	0.16
60V-185	1.85	3.7	60	40	2.1	9.25	8	0.08	0.14
60V-200	2	4	60	40	2.3	10	8	0.07	0.14
60V-250	2.5	5	60	40	2.5	12.5	8	0.05	0.1
60V-300	3	6	60	40	2.8	15	8	0.04	0.08
60V-375	3.75	7.5	60	40	3.2	18.75	24	0.03	0.06
60V-500	5	10	60	40	3.5	25	24	0.02	0.06

Polymer PTC Resettable 72V Series

▲ Features:

- RoHS Compliant & Halogen Free
- Radial leaded Devices
- Cured, flame retardant epoxy polymer insulating material meets UL94V-0 requirements
- Operation Current: 0.05A~3.75A
- Maximum Voltage: 72Vdc, Operating Temperature: -40°C TO 85°C

▲ Product Dimensions

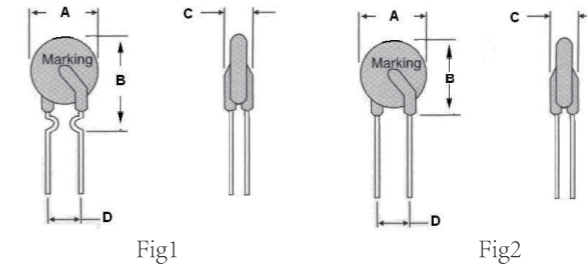

Unit : mm

Model	Dimensions (mm)				Lead material	Shape
	A(max)	B(max)	C(max)	D(typ)	Tinned matel(mm)	Fig
72V-005	5	8.5	3	5.1	24AWG/φ0.8	1
72V-010	5.5	9.5	3	5.1	24AWG/φ0.8	1
72V-017	7.4	12.7	3	5.1	24AWG/φ0.8	1
72V-020	7.4	12.7	3	5.1	24AWG/φ0.8	1
72V-025	7.4	12.7	3	5.1	24AWG/φ0.8	1
72V-030	7.4	13	3	5.1	24AWG/φ0.8	1
72V-040	7.8	16.2	3	5.1	24AWG/φ0.8	1
72V-050	7.8	16.2	3	5.1	24AWG/φ0.8	1
72V-065	9.7	17.8	3	5.1	24AWG/φ0.8	1
72V-075	10.4	18.4	3	5.1	24AWG/φ0.8	1
72V-090	11.7	18.4	3	5.1	24AWG/φ0.8	1
72V-110	13	18	3	5.1	24AWG/φ0.8	2
72V-135	14.5	19.6	3	5.1	24AWG/φ0.8	2
72V-160	16.3	21.3	3	5.1	24AWG/φ0.8	2
72V-185	17.8	22.9	3	5.1	24AWG/φ0.8	2
72V-200	17.8	22.9	3	5.1	24AWG/φ0.8	2
72V-250	21.3	26.4	3	10.2	24AWG/φ0.8	2
72V-300	21.3	26.4	3	10.2	24AWG/φ0.8	2
72V-375	28.5	33.5	3	10.2	24AWG/φ0.8	2

Note: ① Dimensions A, B, C is the maximum size, D values are typical tolerance of ± 0.50mm

Thermal Derating Chart-IH (A)

Model	Maximum ambient operating temperatures (°C)									
	-40	-20	0	25	40	50	60	70	80	85
72V-005	0.08	0.07	0.06	0.05	0.04	0.04	0.03	0.03	0.02	0.02
72V-010	0.15	0.13	0.12	0.1	0.09	0.08	0.07	0.06	0.05	0.04
72V-017	0.25	0.23	0.2	0.17	0.15	0.13	0.12	0.1	0.09	0.06
72V-020	0.3	0.27	0.24	0.2	0.18	0.16	0.14	0.12	0.1	0.08
72V-025	0.37	0.34	0.3	0.25	0.22	0.2	0.18	0.15	0.13	0.1
72V-030	0.45	0.4	0.35	0.3	0.27	0.24	0.21	0.19	0.16	0.12
72V-040	0.6	0.54	0.47	0.4	0.36	0.32	0.28	0.25	0.21	0.16
72V-050	0.75	0.68	0.59	0.5	0.45	0.4	0.36	0.31	0.27	0.2
72V-065	0.97	0.88	0.77	0.65	0.58	0.52	0.46	0.41	0.35	0.26
72V-075	1.12	1.02	0.89	0.75	0.67	0.6	0.54	0.47	0.4	0.3
72V-090	1.35	1.22	1.07	0.9	0.81	0.73	0.64	0.56	0.48	0.36
72V-110	1.65	1.49	1.31	1.1	0.99	0.89	0.79	0.69	0.59	0.44
72V-135	2.02	1.83	1.6	1.35	1.21	1.09	0.97	0.85	0.72	0.54
72V-160	2.4	2.17	1.9	1.6	1.44	1.29	1.15	1	0.86	0.64
72V-185	2.77	2.51	2.2	1.85	1.66	1.49	1.33	1.16	1	0.74
72V-200	3	2.72	2.38	2	1.8	1.62	1.44	1.26	1.08	0.8
72V-250	3.75	3.4	2.97	2.5	2.25	2.02	1.8	1.57	1.35	1
72V-300	4.5	4.08	3.57	3	2.7	2.43	2.16	1.89	1.62	1.2
72V-375	5.62	5.1	4.46	3.75	3.37	3.03	2.7	2.36	2.02	1.5

Electrical Characteristic

Model	IHold	ITrip	Vmax	Imax	Pd Max	Maximum Time to Trip		Nominal resistance (mΩ)	
	(A)	(A)	V (DC)	A	W	Current (A)	Time (S)	Rmin	Rmax
72V-005	0.05	0.15	72	40	0.26	0.25	8	7.3	20
72V-010	0.1	0.3	72	40	0.38	0.5	5	2.5	7.5
72V-017	0.17	0.34	72	40	0.48	0.85	5	2	5.21
72V-020	0.2	0.4	72	40	0.41	1	5	1.5	2.84
72V-025	0.25	0.5	72	40	0.45	1.25	5	1	1.95
72V-030	0.3	0.6	72	40	0.49	1.5	5	0.76	1.38
72V-040	0.4	0.8	72	40	0.56	2	5	0.45	0.88
72V-050	0.5	1	72	40	0.77	2.5	5	0.4	0.79
72V-065	0.65	1.3	72	40	0.88	3.25	5	0.31	0.5
72V-075	0.75	1.5	72	40	0.92	3.75	5	0.25	0.42
72V-090	0.9	1.8	72	40	0.99	4.5	5	0.2	0.33
72V-110	1.1	2.2	72	40	1.5	5.5	8	0.15	0.27
72V-135	1.35	2.7	72	40	1.7	6.75	8	0.12	0.21
72V-160	1.6	3.2	72	40	1.9	8	8	0.09	0.16
72V-185	1.85	3.7	72	40	2.1	9.25	8	0.08	0.14
72V-200	2	4	72	40	2.3	10	8	0.07	0.14
72V-250	2.5	5	72	40	2.5	12.5	8	0.05	0.1
72V-300	3	6	72	40	2.8	15	8	0.04	0.08
72V-375	3.75	7.5	72	40	3.2	18.75	24	0.03	0.06

Thermal Derating Chart-IH (A)

Model	Maximum ambient operating temperatures (°C)									
	-40	-20	0	25	40	50	60	70	80	85
72V-005	0.08	0.07	0.06	0.05	0.04	0.04	0.03	0.03	0.02	0.02
72V-010	0.15	0.13	0.12	0.1	0.09	0.08	0.07	0.06	0.05	0.04
72V-017	0.25	0.23	0.2	0.17	0.15	0.13	0.12	0.1	0.09	0.06
72V-020	0.3	0.27	0.24	0.2	0.18	0.16	0.14	0.12	0.1	0.08
72V-025	0.37	0.34	0.3	0.25	0.22	0.2	0.18	0.15	0.13	0.1
72V-030	0.45	0.4	0.35	0.3	0.27	0.24	0.21	0.19	0.16	0.12
72V-040	0.6	0.54	0.47	0.4	0.36	0.32	0.28	0.25	0.21	0.16
72V-050	0.75	0.68	0.59	0.5	0.45	0.4	0.36	0.31	0.27	0.2
72V-065	0.97	0.88	0.77	0.65	0.58	0.52	0.46	0.41	0.35	0.26
72V-075	1.12	1.02	0.89	0.75	0.67	0.6	0.54	0.47	0.4	0.3
72V-090	1.35	1.22	1.07	0.9	0.81	0.73	0.64	0.56	0.48	0.36
72V-110	1.65	1.49	1.31	1.1	0.99	0.89	0.79	0.69	0.59	0.44
72V-135	2.02	1.83	1.6	1.35	1.21	1.09	0.97	0.85	0.72	0.54
72V-160	2.4	2.17	1.9	1.6	1.44	1.29	1.15	1	0.86	0.64
72V-185	2.77	2.51	2.2	1.85	1.66	1.49	1.33	1.16	1	0.74
72V-200	3	2.72	2.38	2	1.8	1.62	1.44	1.26	1.08	0.8
72V-250	3.75	3.4	2.97	2.5	2.25	2.02	1.8	1.57	1.35	1
72V-300	4.5	4.08	3.57	3	2.7	2.43	2.16	1.89	1.62	1.2
72V-375	5.62	5.1	4.46	3.75	3.37	3.03	2.7	2.36	2.02	1.5

Electrical Characteristic

Model	IHold	ITrip	Vmax	Imax	Pd Max	Maximum Time to Trip		Nominal resistance (mΩ)	
	(A)	(A)	V (DC)	A	W	Current (A)	Time (S)	Rmin	Rmax
72V-005	0.05	0.15	72	40	0.26	0.25	8	7.3	20
72V-010	0.1	0.3	72	40	0.38	0.5	5	2.5	7.5
72V-017	0.17	0.34	72	40	0.48	0.85	5	2	5.21
72V-020	0.2	0.4	72	40	0.41	1	5	1.5	2.84
72V-025	0.25	0.5	72	40	0.45	1.25	5	1	1.95
72V-030	0.3	0.6	72	40	0.49	1.5	5	0.76	1.38
72V-040	0.4	0.8	72	40	0.56	2	5	0.45	0.88
72V-050	0.5	1	72	40	0.77	2.5	5	0.4	0.79
72V-065	0.65	1.3	72	40	0.88	3.25	5	0.31	0.5
72V-075	0.75	1.5	72	40	0.92	3.75	5	0.25	0.42
72V-090	0.9	1.8	72	40	0.99	4.5	5	0.2	0.33
72V-110	1.1	2.2	72	40	1.5	5.5	8	0.15	0.27
72V-135	1.35	2.7	72	40	1.7	6.75	8	0.12	0.21
72V-160	1.6	3.2	72	40	1.9	8	8	0.09	0.16
72V-185	1.85	3.7	72	40	2.1	9.25	8	0.08	0.14
72V-200	2	4	72	40	2.3	10	8	0.07	0.14
72V-250	2.5	5	72	40	2.5	12.5	8	0.05	0.1
72V-300	3	6	72	40	2.8	15	8	0.04	0.08
72V-375	3.75	7.5	72	40	3.2	18.75	24	0.03	0.06

Polymer PTC Resettable 130V Series

- ▲ Features:
 - Radial leaded Devices
 - Cured, flame retardant epoxy polymer insulating material meets UL94V-0
 - Rohs compliant and lead-free
 - Agency recognition

▲ Product Dimensions

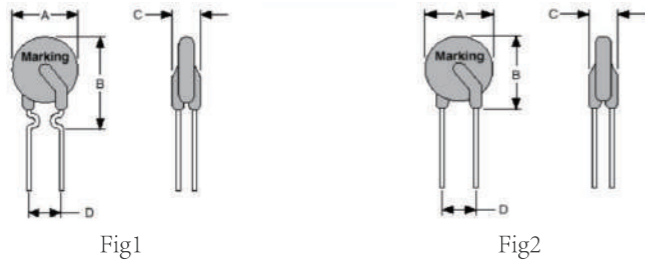

Unit : mm

Model	Dimensions (mm)				Lead material	Shape
	A(max)	B(max)	C(max)	D(typ)	Tinned matel(mm)	Fig
130V-010	7.4	12.7	3.8	5.1	22AWG/Φ0.6	1
130V-015	7.4	13	3.8	5.1	22AWG/Φ0.6	1
130V-017	7.4	13.5	3.8	5.1	22AWG/Φ0.6	1
130V-020	7.6	13.5	3.8	5.1	22AWG/Φ0.6	1
130V-025	7.6	13.5	3.8	5.1	22AWG/Φ0.6	1
130V-030	8	14	3.8	5.1	22AWG/Φ0.6	1
130V-040	9.4	15	3.8	5.1	22AWG/Φ0.6	1
130V-050	10.2	15.2	3.8	5.1	22AWG/Φ0.6	1
130V-065	12.8	18	3.8	5.1	22AWG/Φ0.6	1
130V-075	12.8	18	3.8	5.1	22AWG/Φ0.6	1
130V-090	14.5	19.6	3.8	5.1	20AWG/Φ0.8	2
130V-110	16.3	21.3	3.8	5.1	20AWG/Φ0.8	2
130V-135	17	22	3.8	5.1	20AWG/Φ0.8	2
130V-160	20	25	3.8	5.1	20AWG/Φ0.8	2
130V-185	22	23	3.8	5.1	20AWG/Φ0.8	2
130V-200	25	27	3.8	10.2	20AWG/Φ0.8	2
130V-250	27	32	3.8	10.2	20 AWG/Φ0.8	2

Note: ① Dimensions A, B, C is the maximum size, D values are typical tolerance of ± 0.50mm

Thermal Derating Chart-IH (A)

Model	Maximum ambient operating temperatures (°C)								
	-40	-20	0	25	40	50	60	70	85
130V-010	0.15	0.13	0.12	0.1	0.085	0.076	0.067	0.06	0.047
130V-015	0.22	0.2	0.18	0.15	0.013	0.011	0.1	0.09	0.07
130V-017	0.25	0.22	0.2	0.17	0.14	0.13	0.11	0.1	0.08
130V-020	0.29	0.26	0.24	0.2	0.17	0.15	0.13	0.12	0.09
130V-025	0.37	0.33	0.3	0.25	0.21	0.19	0.17	0.15	0.12
130V-030	0.44	0.4	0.35	0.3	0.26	0.23	0.2	0.18	0.14
130V-040	0.59	0.53	0.47	0.4	0.34	0.3	0.27	0.24	0.19
130V-050	0.74	0.66	0.59	0.5	0.43	0.38	0.34	0.3	0.24
130V-065	0.96	0.86	0.77	0.65	0.55	0.49	0.44	0.39	0.31
130V-075	1.1	0.99	0.89	0.75	0.64	0.57	0.5	0.45	0.35
130V-090	1.32	1.19	1.06	0.9	0.77	0.68	0.6	0.54	0.42
130V-110	1.62	1.45	1.3	1.1	0.94	0.84	0.74	0.66	0.52
130V-135	1.98	1.78	1.59	1.35	1.15	1.03	0.9	0.81	0.63
130V-160	2.35	2.11	1.89	1.6	1.36	1.22	1.07	0.96	0.75
130V-185	2.72	2.44	2.18	1.85	1.57	1.41	1.24	1.11	0.87
130V-200	2.94	2.64	2.36	2	1.7	1.52	1.34	1.2	0.94
130V-250	3.68	3.3	2.95	2.5	2.13	1.9	1.68	1.5	1.18

Polymer PTC Resettable 130V Series

- ▲ Features:
 - Radial leaded Devices
 - Cured, flame retardant epoxy polymer insulating material meets UL94V-0
 - Rohs compliant and lead-free
 - Agency recognition

▲ Product Dimensions

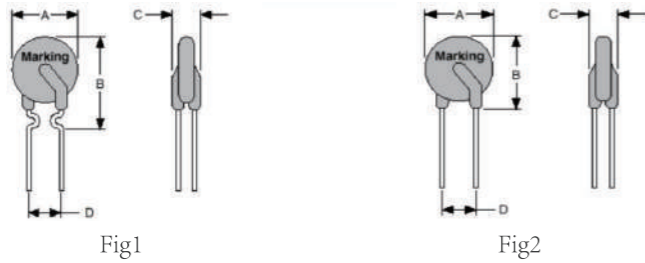

Unit : mm

Model	Dimensions (mm)				Lead material	Shape
	A(max)	B(max)	C(max)	D(typ)	Tinned matel(mm)	Fig
130V-010	7.4	12.7	3.8	5.1	22AWG/Φ0.6	1
130V-015	7.4	13	3.8	5.1	22AWG/Φ0.6	1
130V-017	7.4	13.5	3.8	5.1	22AWG/Φ0.6	1
130V-020	7.6	13.5	3.8	5.1	22AWG/Φ0.6	1
130V-025	7.6	13.5	3.8	5.1	22AWG/Φ0.6	1
130V-030	8	14	3.8	5.1	22AWG/Φ0.6	1
130V-040	9.4	15	3.8	5.1	22AWG/Φ0.6	1
130V-050	10.2	15.2	3.8	5.1	22AWG/Φ0.6	1
130V-065	12.8	18	3.8	5.1	22AWG/Φ0.6	1
130V-075	12.8	18	3.8	5.1	22AWG/Φ0.6	1
130V-090	14.5	19.6	3.8	5.1	20AWG/Φ0.8	2
130V-110	16.3	21.3	3.8	5.1	20AWG/Φ0.8	2
130V-135	17	22	3.8	5.1	20AWG/Φ0.8	2
130V-160	20	25	3.8	5.1	20AWG/Φ0.8	2
130V-185	22	23	3.8	5.1	20AWG/Φ0.8	2
130V-200	25	27	3.8	10.2	20AWG/Φ0.8	2
130V-250	27	32	3.8	10.2	20 AWG/Φ0.8	2

Note: ① Dimensions A, B, C is the maximum size, D values are typical tolerance of ± 0.50mm

Thermal Derating Chart-IH (A)

Model	Maximum ambient operating temperatures (°C)								
	-40	-20	0	25	40	50	60	70	85
130V-010	0.15	0.13	0.12	0.1	0.085	0.076	0.067	0.06	0.047
130V-015	0.22	0.2	0.18	0.15	0.013	0.011	0.1	0.09	0.07
130V-017	0.25	0.22	0.2	0.17	0.14	0.13	0.11	0.1	0.08
130V-020	0.29	0.26	0.24	0.2	0.17	0.15	0.13	0.12	0.09
130V-025	0.37	0.33	0.3	0.25	0.21	0.19	0.17	0.15	0.12
130V-030	0.44	0.4	0.35	0.3	0.26	0.23	0.2	0.18	0.14
130V-040	0.59	0.53	0.47	0.4	0.34	0.3	0.27	0.24	0.19
130V-050	0.74	0.66	0.59	0.5	0.43	0.38	0.34	0.3	0.24
130V-065	0.96	0.86	0.77	0.65	0.55	0.49	0.44	0.39	0.31
130V-075	1.1	0.99	0.89	0.75	0.64	0.57	0.5	0.45	0.35
130V-090	1.32	1.19	1.06	0.9	0.77	0.68	0.6	0.54	0.42
130V-110	1.62	1.45	1.3	1.1	0.94	0.84	0.74	0.66	0.52
130V-135	1.98	1.78	1.59	1.35	1.15	1.03	0.9	0.81	0.63
130V-160	2.35	2.11	1.89	1.6	1.36	1.22	1.07	0.96	0.75
130V-185	2.72	2.44	2.18	1.85	1.57	1.41	1.24	1.11	0.87
130V-200	2.94	2.64	2.36	2	1.7	1.52	1.34	1.2	0.94
130V-250	3.68	3.3	2.95	2.5	2.13	1.9	1.68	1.5	1.18

Electrical Characteristic

Model	I _{Hold}	I _{Trip}	V _{max}	I _{max}	P _d Max	Maximum Time to Trip		Nominal resistance (mΩ)	
	(A)	(A)	V (DC)	A	W	Current (A)	Time (S)	R _{min}	R _{max}
130V-010	0.1	0.2	130	3	0.8	0.5	6	2.5	9
130V-015	0.15	0.3	130	3	0.8	0.75	5.5	2.5	7.5
130V-017	0.17	0.34	130	3	0.8	0.85	5.2	1.5	7
130V-020	0.2	0.4	130	3	0.8	1	5	1.9	4
130V-025	0.25	0.5	130	3	1	1.25	4.8	1.45	3.5
130V-030	0.3	0.6	130	3	1	1.5	4.5	1	3
130V-040	0.4	0.8	130	3	1	2	4.5	0.75	2
130V-050	0.5	1	130	3	1	2.5	5	0.5	1.6
130V-065	0.65	1.3	130	10	1	3.25	5.2	0.45	1
130V-075	0.75	1.5	130	10	1	3.75	5.5	0.4	0.9
130V-090	0.9	1.8	130	10	1.5	4.5	5.8	0.3	0.7
130V-110	1.1	2.2	130	10	1.8	5.5	6.3	0.2	0.65
130V-135	1.35	2.7	130	10	1.8	6.75	7.5	0.15	0.6
130V-160	1.6	3.2	130	10	2	8	8	0.1	0.5
130V-185	1.85	3.7	130	10	2	9.25	9	0.1	0.4
130V-200	2	4	130	10	2.2	10	10	0.1	0.3
130V-250	2.5	5	130	10	2.5	12.5	12	0.05	0.25

Polymer PTC Resettable 250V Series

▲ Features:

- Radial leaded Devices
- Cured, flame retardant epoxy polymer insulating material meets UL94V-0 requirements
- Rohs compliant and lead-free

▲ Product Dimensions

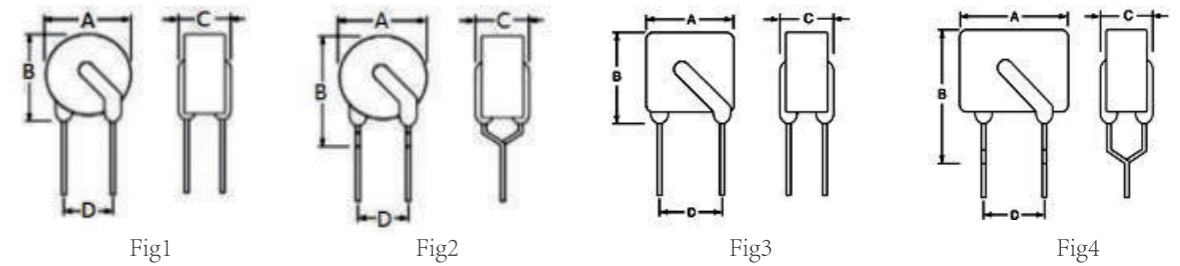

Unit : mm

Model	Dimensions (mm)				Lead material	Shape
	A(max)	B(max)	C(max)	D(typ)	Tinned matel(mm)	Fig
250V-020	7.4	12.7	4.5	5.1	22AWG/Φ0.6	1
250V-030	7.4	12.7	4.5	5.1	22AWG/Φ0.6	1
250V-040	7.4	12.7	4.5	5.1	22AWG/Φ0.6	1/2
250V-050	7.4	12.7	4.5	5.1	22AWG/Φ0.6	1/2
250V-060	7.4	12.7	4.5	5.1	22AWG/Φ0.6	1/2
250V-080	7.4	12.7	4.5	5.1	22AWG/Φ0.6	2
250V-090	7.4	12.7	4.5	5.1	22AWG/Φ0.6	2
250V-100	7.8	12.6	4.5	5.1	22AWG/Φ0.6	1
250V-110	7	12.6	4.5	5.1	22AWG/Φ0.6	4
250V-120	7	12.6	4.5	5.1	22AWG/Φ0.6	4
250V-145	7	12.6	4.5	5.1	22AWG/Φ0.6	4
250V-180	10.2	14.5	3.8	5.1	22AWG/Φ0.6	2
250V-200	12	17	4.5	5.1	22AWG/Φ0.6	3
250V-400	12	17	4.5	5.1	22AWG/Φ0.6	3
250V-600	16	18	4.5	5.1	22AWG/Φ0.6	3
250V-800	20	22.5	4.5	5.1	20 AWG/Φ0.8	3
250V-1000	20	22.5	4.5	5.1	20 AWG/Φ0.8	3
250V-1200	22	28	4.5	5.1	20 AWG/Φ0.8	3
250V-1500	25	30	4.5	5.1	20 AWG/Φ0.8	3
250V-2000	26	32	4.5	10.2	20 AWG/Φ0.8	3

Note: ① Dimensions A, B, C is the maximum size, D values are typical tolerance of ± 0.50mm

Electrical Characteristic

Model	I _{Hold}	I _{Trip}	V _{max}	I _{max}	P _d Max	Maximum Time to Trip		Nominal resistance (mΩ)	
	(A)	(A)	V (DC)	A	W	Current (A)	Time (S)	R _{min}	R _{max}
130V-010	0.1	0.2	130	3	0.8	0.5	6	2.5	9
130V-015	0.15	0.3	130	3	0.8	0.75	5.5	2.5	7.5
130V-017	0.17	0.34	130	3	0.8	0.85	5.2	1.5	7
130V-020	0.2	0.4	130	3	0.8	1	5	1.9	4
130V-025	0.25	0.5	130	3	1	1.25	4.8	1.45	3.5
130V-030	0.3	0.6	130	3	1	1.5	4.5	1	3
130V-040	0.4	0.8	130	3	1	2	4.5	0.75	2
130V-050	0.5	1	130	3	1	2.5	5	0.5	1.6
130V-065	0.65	1.3	130	10	1	3.25	5.2	0.45	1
130V-075	0.75	1.5	130	10	1	3.75	5.5	0.4	0.9
130V-090	0.9	1.8	130	10	1.5	4.5	5.8	0.3	0.7
130V-110	1.1	2.2	130	10	1.8	5.5	6.3	0.2	0.65
130V-135	1.35	2.7	130	10	1.8	6.75	7.5	0.15	0.6
130V-160	1.6	3.2	130	10	2	8	8	0.1	0.5
130V-185	1.85	3.7	130	10	2	9.25	9	0.1	0.4
130V-200	2	4	130	10	2.2	10	10	0.1	0.3
130V-250	2.5	5	130	10	2.5	12.5	12	0.05	0.25

Polymer PTC Resettable 250V Series

▲ Features:

- Radial leaded Devices
- Cured, flame retardant epoxy polymer insulating material meets UL94V-0 requirements
- Rohs compliant and lead-free

▲ Product Dimensions

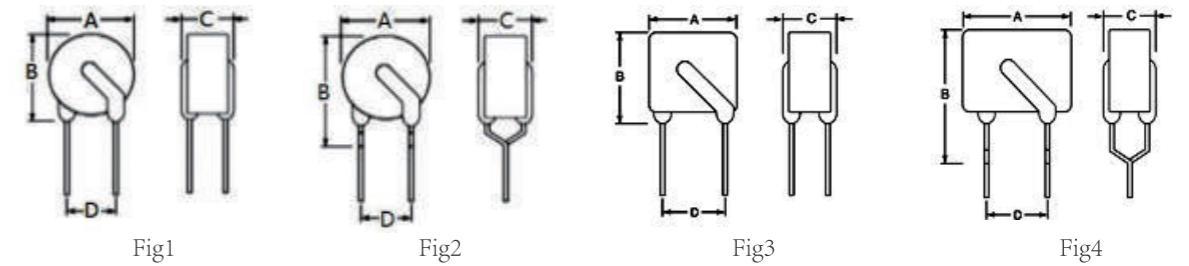

Unit : mm

Model	Dimensions (mm)				Lead material	Shape
	A(max)	B(max)	C(max)	D(typ)	Tinned matel(mm)	Fig
250V-020	7.4	12.7	4.5	5.1	22AWG/φ0.6	1
250V-030	7.4	12.7	4.5	5.1	22AWG/φ0.6	1
250V-040	7.4	12.7	4.5	5.1	22AWG/φ0.6	1/2
250V-050	7.4	12.7	4.5	5.1	22AWG/φ0.6	1/2
250V-060	7.4	12.7	4.5	5.1	22AWG/φ0.6	1/2
250V-080	7.4	12.7	4.5	5.1	22AWG/φ0.6	2
250V-090	7.4	12.7	4.5	5.1	22AWG/φ0.6	2
250V-100	7.8	12.6	4.5	5.1	22AWG/φ0.6	1
250V-110	7	12.6	4.5	5.1	22AWG/φ0.6	4
250V-120	7	12.6	4.5	5.1	22AWG/φ0.6	4
250V-145	7	12.6	4.5	5.1	22AWG/φ0.6	4
250V-180	10.2	14.5	3.8	5.1	22AWG/φ0.6	2
250V-200	12	17	4.5	5.1	22AWG/φ0.6	3
250V-400	12	17	4.5	5.1	22AWG/φ0.6	3
250V-600	16	18	4.5	5.1	22AWG/φ0.6	3
250V-800	20	22.5	4.5	5.1	20 AWG/φ0.8	3
250V-1000	20	22.5	4.5	5.1	20 AWG/φ0.8	3
250V-1200	22	28	4.5	5.1	20 AWG/φ0.8	3
250V-1500	25	30	4.5	5.1	20 AWG/φ0.8	3
250V-2000	26	32	4.5	10.2	20 AWG/φ0.8	3

Note: ① Dimensions A, B, C is the maximum size, D values are typical tolerance of ± 0.50mm

Thermal Derating Chart-IH (A)

Model	Maximum ambient operating temperatures (°C)								
	-40	-20	0	25	40	50	60	70	85
250V-020	0.03	0.026	0.023	0.02	0.017	0.015	0.014	0.012	0.009
250V-030	0.044	0.04	0.035	0.03	0.026	0.023	0.02	0.018	0.014
250V-040	0.059	0.053	0.047	0.04	0.034	0.031	0.027	0.024	0.018
250V-050	0.074	0.066	0.059	0.05	0.043	0.039	0.034	0.031	0.023
250V-060	0.089	0.079	0.07	0.06	0.051	0.046	0.041	0.037	0.027
250V-080	0.118	0.106	0.094	0.08	0.068	0.062	0.054	0.049	0.036
250V-090	0.133	0.119	0.105	0.09	0.077	0.069	0.061	0.055	0.041
250V-100	0.148	0.132	0.117	0.1	0.085	0.077	0.068	0.061	0.045
250V-110	0.163	0.145	0.129	0.11	0.094	0.085	0.075	0.067	0.05
250V-120	0.178	0.158	0.14	0.12	0.102	0.092	0.082	0.073	0.054
250V-145	0.215	0.191	0.17	0.145	0.123	0.112	0.099	0.088	0.064
250V-180	0.266	0.238	0.211	0.18	0.153	0.139	0.122	0.11	0.081
250V-200	0.296	0.264	0.234	0.2	0.17	0.154	0.136	0.122	0.09
250V-400	0.592	0.528	0.468	0.4	0.34	0.308	0.272	0.244	0.18
250V-600	0.888	0.792	0.702	0.6	0.51	0.462	0.408	0.366	0.27
250V-800	1.184	1.056	0.936	0.8	0.68	0.616	0.544	0.488	0.36
250V-1000	1.48	1.32	1.17	1	0.85	0.77	0.68	0.61	0.45
250V-1200	1.776	1.584	1.404	1.2	1.02	0.924	0.816	0.732	0.54
250V-1500	2.22	1.98	1.755	1.5	1.275	1.155	1.02	0.915	0.675
250V-2000	2.96	2.64	2.34	2	1.7	1.54	0.36	1.22	0.9

Electrical Characteristic

Model	IHold	ITrip	Vmax	I _{max}	Pd Max	Maximum Time to Trip		Nominal resistance (m Ω)	
	(A)	(A)	V (DC)	A	W	Current (A)	Time (S)	Rmin	Rmax
250V-020	20	45	250	3	1	0.5	0.5	80	160
250V-030	30	65	250	3	1	0.5	0.5	60	120
250V-040	40	80	250	3	1	0.5	1.5	30	60
250V-050	50	100	250	3	1	0.5	2	25	50
250V-060	60	120	250	3	1	0.5	2	20	60
250V-080	80	160	250	3	1	1	0.5	12	22
250V-090	90	180	250	3	1	1	0.8	10	20
250V-100	100	200	250	3	1	1	1	10	20
250V-110	110	220	250	3	1	1	2	6	12
250V-120	120	240	250	3	1	1	2	6	11
250V-145	145	290	250	3	1	1	5	3.5	6.5
250V-180	180	650	250	3	1.8	3	3	1	2.2
250V-200	200	400	250	5	2.4	3	5	3	6
250V-400	400	800	250	5	2.8	3	8	1	3
250V-600	600	1200	250	5	3.2	3	12	0.6	2
250V-800	800	1600	250	5	3.6	4	18	0.4	1
250V-1000	1000	2000	250	7	3.6	5	20	0.3	0.8
250V-1200	1200	2400	250	7	3.6	6	20	0.2	0.8
250V-1500	1500	3000	250	7	4.8	7.5	20	0.2	0.6
250V-2000	2000	4000	250	10	4.8	10	20	0.2	0.4

Thermal Derating Chart-IH (A)

Model	Maximum ambient operating temperatures (°C)								
	-40	-20	0	25	40	50	60	70	85
250V-020	0.03	0.026	0.023	0.02	0.017	0.015	0.014	0.012	0.009
250V-030	0.044	0.04	0.035	0.03	0.026	0.023	0.02	0.018	0.014
250V-040	0.059	0.053	0.047	0.04	0.034	0.031	0.027	0.024	0.018
250V-050	0.074	0.066	0.059	0.05	0.043	0.039	0.034	0.031	0.023
250V-060	0.089	0.079	0.07	0.06	0.051	0.046	0.041	0.037	0.027
250V-080	0.118	0.106	0.094	0.08	0.068	0.062	0.054	0.049	0.036
250V-090	0.133	0.119	0.105	0.09	0.077	0.069	0.061	0.055	0.041
250V-100	0.148	0.132	0.117	0.1	0.085	0.077	0.068	0.061	0.045
250V-110	0.163	0.145	0.129	0.11	0.094	0.085	0.075	0.067	0.05
250V-120	0.178	0.158	0.14	0.12	0.102	0.092	0.082	0.073	0.054
250V-145	0.215	0.191	0.17	0.145	0.123	0.112	0.099	0.088	0.064
250V-180	0.266	0.238	0.211	0.18	0.153	0.139	0.122	0.11	0.081
250V-200	0.296	0.264	0.234	0.2	0.17	0.154	0.136	0.122	0.09
250V-400	0.592	0.528	0.468	0.4	0.34	0.308	0.272	0.244	0.18
250V-600	0.888	0.792	0.702	0.6	0.51	0.462	0.408	0.366	0.27
250V-800	1.184	1.056	0.936	0.8	0.68	0.616	0.544	0.488	0.36
250V-1000	1.48	1.32	1.17	1	0.85	0.77	0.68	0.61	0.45
250V-1200	1.776	1.584	1.404	1.2	1.02	0.924	0.816	0.732	0.54
250V-1500	2.22	1.98	1.755	1.5	1.275	1.155	1.02	0.915	0.675
250V-2000	2.96	2.64	2.34	2	1.7	1.54	0.36	1.22	0.9

Electrical Characteristic

Model	IHold	ITrip	Vmax	I _{max}	Pd Max	Maximum Time to Trip		Nominal resistance (mΩ)	
	(A)	(A)	V (DC)	A	W	Current (A)	Time (S)	Rmin	Rmax
250V-020	20	45	250	3	1	0.5	0.5	80	160
250V-030	30	65	250	3	1	0.5	0.5	60	120
250V-040	40	80	250	3	1	0.5	1.5	30	60
250V-050	50	100	250	3	1	0.5	2	25	50
250V-060	60	120	250	3	1	0.5	2	20	60
250V-080	80	160	250	3	1	1	0.5	12	22
250V-090	90	180	250	3	1	1	0.8	10	20
250V-100	100	200	250	3	1	1	1	10	20
250V-110	110	220	250	3	1	1	2	6	12
250V-120	120	240	250	3	1	1	2	6	11
250V-145	145	290	250	3	1	1	5	3.5	6.5
250V-180	180	650	250	3	1.8	3	3	1	2.2
250V-200	200	400	250	5	2.4	3	5	3	6
250V-400	400	800	250	5	2.8	3	8	1	3
250V-600	600	1200	250	5	3.2	3	12	0.6	2
250V-800	800	1600	250	5	3.6	4	18	0.4	1
250V-1000	1000	2000	250	7	3.6	5	20	0.3	0.8
250V-1200	1200	2400	250	7	3.6	6	20	0.2	0.8
250V-1500	1500	3000	250	7	4.8	7.5	20	0.2	0.6
250V-2000	2000	4000	250	10	4.8	10	20	0.2	0.4

Polymer PTC Resettable 600V Series

- ▲ Features:
 - Radial leaded Devices
 - Cured, flame retardant epoxy polymer insulating material meets UL94V-0
 - Rohs compliant and lead-free

▲ Product Dimensions

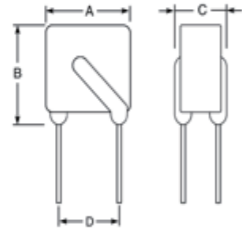

Fig1

Unit : mm

Model	Dimensions (mm)				Lead material	Shape
	A(max)	B(max)	C(max)	D(typ)	Tinned matel(mm)	
600V-030	15	15	5.5	5.1	22AWG/Φ0.6	1
600V-040	15	15	5.5	5.1	22AWG/Φ0.6	1
600V-060	15	15	5.5	5.1	22AWG/Φ0.6	1
600V-080	15	15	5.5	5.1	22AWG/Φ0.6	1
600V-110	15	15	5.5	5.1	22AWG/Φ0.6	1
600V-150	15	15	5.5	5.1	22AWG/Φ0.6	1
600V-160	15	15	5.5	5.1	22AWG/Φ0.6	1
600V-200	15	15	5.5	5.1	22AWG/Φ0.6	1

Note: ① Dimensions A, B, C is the maximum size, D values are typical tolerance of ± 0.50mm

Thermal Derating Chart-IH (A)

Model	Maximum ambient operating temperatures (°C)									
	-40	-20	0	25	30	40	50	60	70	85
600V-Series	147%	138%	119%	100%	92%	83%	73%	64%	55%	42%

Electrical Characteristic

Model	I _{Hold}	I _{Trip}	V _{max}	I _{max}	P _d Max	Maximum Time to Trip		Nominal resistance (mΩ)	
	(A)	(A)	V (DC)	A	W	Current (A)	Time (S)	R _{min}	R _{max}
600V-030	0.03	600	3	1	1	10	30	60	90
600V-040	0.04	600	3	1	1	7	15	40	60
600V-060	0.06	600	3	1	1	8	15	45	45
600V-080	0.08	600	3	1	1	8	10	30	35
600V-110	0.11	600	3	1	1	8	6	16	24
600V-150	0.15	600	3	1	1	9	5	14	22
600V-160	0.16	600	3	1	1	10	4	12	18
600V-200	0.2	600	3	1	1	15	5	13	24

Polymer PTC Resettable 600V Series

- ▲ Features:
 - Radial leaded Devices
 - Cured, flame retardant epoxy polymer insulating material meets UL94V-0
 - Rohs compliant and lead-free

▲ Product Dimensions

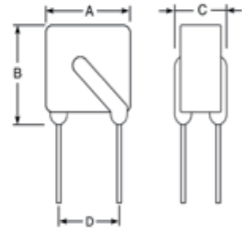

Fig1

Unit : mm

Model	Dimensions (mm)				Lead material	Shape
	A(max)	B(max)	C(max)	D(typ)	Tinned matel(mm)	
600V-030	15	15	5.5	5.1	22AWG/Φ0.6	1
600V-040	15	15	5.5	5.1	22AWG/Φ0.6	1
600V-060	15	15	5.5	5.1	22AWG/Φ0.6	1
600V-080	15	15	5.5	5.1	22AWG/Φ0.6	1
600V-110	15	15	5.5	5.1	22AWG/Φ0.6	1
600V-150	15	15	5.5	5.1	22AWG/Φ0.6	1
600V-160	15	15	5.5	5.1	22AWG/Φ0.6	1
600V-200	15	15	5.5	5.1	22AWG/Φ0.6	1

Note: ① Dimensions A, B, C is the maximum size, D values are typical tolerance of ± 0.50mm

Thermal Derating Chart-IH (A)

Model	Maximum ambient operating temperatures (°C)									
	-40	-20	0	25	30	40	50	60	70	85
600V-Series	147%	138%	119%	100%	92%	83%	73%	64%	55%	42%

Electrical Characteristic

Model	IHold	ITrip	Vmax	Imax	Pd Max	Maximum Time to Trip		Nominal resistance (mΩ)	
	(A)	(A)	V (DC)	A	W	Current (A)	Time (S)	Rmin	Rmax
600V-030	0.03	600	3	1	1	10	30	60	90
600V-040	0.04	600	3	1	1	7	15	40	60
600V-060	0.06	600	3	1	1	8	15	45	45
600V-080	0.08	600	3	1	1	8	10	30	35
600V-110	0.11	600	3	1	1	8	6	16	24
600V-150	0.15	600	3	1	1	9	5	14	22
600V-160	0.16	600	3	1	1	10	4	12	18
600V-200	0.2	600	3	1	1	15	5	13	24

热敏电阻 NTC (Negative Temperature Coefficient)

NTC热敏电阻器是一种以过渡金属氧化物为主要原材料制造的半导体陶瓷元件。它具有电阻值随着温度的变化而相应变化的特性。即在一定的测量功率下，电阻值随着温度上升而下降。利用这一特性，可将NTC热敏电阻器及其温度传感器应用在测控温，温度补偿，和抑制浪涌电流等场合。

Thermistor is a ceramic semiconducting element made from exorbitant oxides materal. It has the feature that the resistance changes according to the ambient temperature. Namely, their resistance declines with the rising of ambient temperature at a determinate measuring power. With this feature NTC thermistor and temperature sensor can be applied in the situation of temperature measurement and control, compensation and surge current protection.

NTC热敏电阻器及其温度传感器的主要参数 Main techno-Parameter of NTC Thermistor

▲ 零功率电阻值R₀ Zero Power Resistance R₀

在规定温度下，采用引起电阻变化相对于总的测量误差来说可以忽略不计的测量功率测得的电阻值。
At rated temperature ,it is the resistance measured by the measuring power which causes the resistance change that can be ignored relative to the whole measuring error.

▲ 额定零功率电阻值R₂₅ Rated Zero Power Resistance R₂₅

也称标称电阻值，通常是指25℃时测得的零功率电阻值。
Also Known as Nominal Resistance,is the zero power resistance measured at 25℃.

▲ B值 B Value

B值是负温度系数热敏电阻器的热敏指数，他被定义为两个温度下零功率电阻值的自然对数之差与这两个温度倒数之差的比值。
B Value is the thermel exponent of negative temperature coefficient thermistor, which is defined as the ratio of the difference between the napierian logarithm of zero power resistance at two temperatures to the difference between the temperatures' reciprocal.

$$B = \ln \frac{R_{T1}}{R_{T2}} / \left(\frac{1}{T_1} - \frac{1}{T_2} \right) = \frac{T_1 T_2}{T_2 - T_1} \ln \frac{R_{T1}}{R_{T2}}$$

式中：R_{T1}—温度为T1时的零功率电阻值
R_{T2}—温度为T2时的零功率电阻值

除非特别指出，B值是由25℃（298.15K）和50℃(323.15K)的零功率电阻值计算而得到的，B值在工作温度范围内并不是一个严格的常数。

In the equation: R_{T1}—The zero power resistance at T1
R_{T2}—The zero power resistance at T2

Unless the particular indication, B value is figured out from the zero power resistance at 25℃（298.15K）and 50℃(323.15K) and B value is not a rigorous constant in the range of operating temperature.

▲ 零功率电阻温度系数α_T Temperature Coefficient of Zero power Resistance α_T

指在规定温度下，热敏电阻器的零功率电阻值随着温度的变化率与它的零功率电阻值之比。
At rated temperature, it is the ratio of the zero power resistance change rate with temperature to the zero power resistance itself. Namely,

$$\alpha_T = \frac{1}{R} \frac{dR_T}{dT} = -\frac{B}{T^2}$$

式中：α_T—温度为T时的零功率电阻温度系数
R_T—温度为T时的零功率电阻值
T—温度（以K表示）
B—B值

α_T—the temperature coefficient of zero power resistance at T
R_T—the zero power resistance at T
T—temperature
B—B value

▲ 耗散系数δ Dissipation coefficient δ

在规定的环境温度下，热敏电阻器耗散功率变化与其相应温度变化之比，即在工作温度范围内，δ随着环境温度的变化而变化。

$$\delta = \frac{\Delta P}{\Delta T}$$

At rated ambient temperature, it is the radio of consumption power change rate of thermistor to the change of the corresponding temperature, namely: In the range of operating temperature, δ has a little change with the ambient.

▲ 热时间常数τ Thermal Time Constant τ

在零功率条件下，当温度发生突变时，热敏电阻体温度变化了始末两个温度差的63.2%所需的时间。
τ与热敏电阻器的热容量C成正比，与其耗散系数δ成反比，即：

$$\tau = \frac{C}{\delta}$$

At zero power, it is measured as time in seconds which needed for thermistor temperature change of 63.2% difference between initial and final thermistor temperature when the temperature breaks.

τ is in direct ratio to thermal capacity C of thermistor and in inverse ratio to the dissipation coefficient δ, namely:

▲ 电阻-温度特性 Resistance-Temperature Characteristic

热敏电阻器的零功率电阻值与其电阻体温度之间的依赖关系。
The reliant relationship between the zero power resistance of thermistor and its temperature.

▲ R值与B值关系 R-T curve NTC thermisor

热敏电阻器的零功率电阻值与其电阻体温度之间的依赖关系。
The reliant relationship between the zero power resistance of thermistor and its temperature.

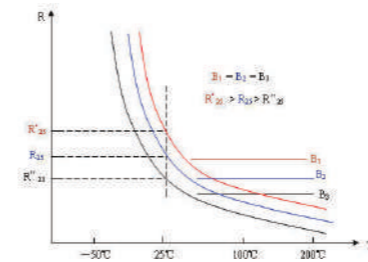

B值相同，阻值不同的R-T特性曲线示意图
R-T curve based on same B value, different resistance

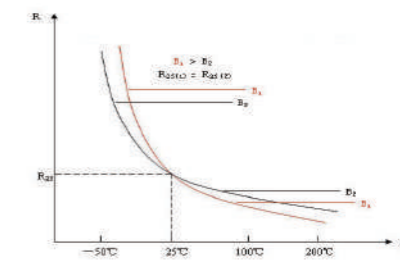

相同阻值，不同B值的R-T特性曲线示意图
R-T curve based on different B value, same resistance

热敏电阻 NTC (Negative Temperature Coefficient)

NTC热敏电阻器是一种以过渡金属氧化物为主要原材料制造的半导体陶瓷元件。它具有电阻值随着温度的变化而相应变化的特性。即在一定的测量功率下，电阻值随着温度上升而下降。利用这一特性，可将NTC热敏电阻器及其温度传感器应用在测控温，温度补偿，和抑制浪涌电流等场合。

Thermistor is a ceramic semiconducting element made from exorbitant oxides materal. It has the feature that the resistance changes according to the ambient temperature. Namely, their resistance declines with the rising of ambient temperature at a determinate measuring power. With this feature NTC thermistor and temperature sensor can be applied in the situation of temperature measurement and control, compensation and surge current protection.

NTC热敏电阻器及其温度传感器的主要参数 Main techno-Parameter of NTC Thermistor

▲ 零功率电阻值R_r Zero Power Resistance R_r

在规定温度下，采用引起电阻变化相对于总的测量误差来说可以忽略不计的测量功率测得的电阻值。
At rated temperature ,it is the resistance measured by the measuring power which causes the resistance change that can be ignored relative to the whole measuring error.

▲ 额定零功率电阻值R₂₅ Rated Zero Power Resistance R₂₅

也称标称电阻值，通常是指25℃时测得的零功率电阻值。
Also Known as Nominal Resistance,is the zero power resistance measured at 25℃.

▲ B值 B Value

B值是负温度系数热敏电阻器的热敏指数，他被定义为两个温度下零功率电阻值的自然对数之差与这两个温度倒数之差的比值。
B Value is the thermal exponent of negative temperature coefficient thermistor, which is defined as the ratio of the difference between the napierian logarithm of zero power resistance at two temperatures to the difference between the temperatures' reciprocal.

$$B = \ln \frac{R_{T1}}{R_{T2}} / \left(\frac{1}{T_1} - \frac{1}{T_2} \right) = \frac{T_1 T_2}{T_2 - T_1} \ln \frac{R_{T1}}{R_{T2}}$$

式中：R_{T1}—温度为T1时的零功率电阻值
R_{T2}—温度为T2时的零功率电阻值

除非特别指出，B值是由25℃（298.15K）和50℃(323.15K)的零功率电阻值计算而得到的，B值在工作温度范围内并不是一个严格的常数。

In the equation: R_{T1}—The zero power resistance at T1
R_{T2}—The zero power resistance at T2

Unless the particular indication, B value is figured out from the zero power resistance at 25℃（298.15K）and 50℃(323.15K) and B value is not a rigorous constant in the range of operating temperature.

▲ 零功率电阻温度系数α_r Temperature Coefficient of Zero power Resistance α_r

指在规定温度下，热敏电阻器的零功率电阻值随着温度的变化率与它的零功率电阻值之比。
At rated temperature, it is the ratio of the zero power resistance change rate with temperature to the zero power resistance itself. Namely,

$$\alpha_r = \frac{1}{R} \frac{dR_r}{dT} = -\frac{B}{T^2}$$

式中：α_r—温度为T时的零功率电阻温度系数
R_r—温度为T时的零功率电阻值
T—温度（以K表示）
B—B值

α_r—the temperature coefficient of zero power resistance at T
R_r—the zero power resistance at T
T—temperature
B—B value

▲ 耗散系数δ Dissipation coefficient δ

在规定的环境温度下，热敏电阻器耗散功率变化与其相应温度变化之比，即在工作温度范围内，δ随着环境温度的变化而变化。
At rated ambient temperature, it is the radio of consumption power change rate of thermistor to the change of the corresponding temperature, namely: In the range of operating temperature, δ has a little change with the ambient.

$$\delta = \frac{\Delta P}{\Delta T}$$

▲ 热时间常数τ Thermal Time Constant τ

在零功率条件下，当温度发生突变时，热敏电阻体温度变化了始末两个温度差的63.2%所需的时间。
τ与热敏电阻器的热容量C成正比，与其耗散系数δ成反比，即：
At zero power, it is measured as time in seconds which needed for thermistor temperature change of 63.2% difference between initial and final thermistor temperature when the temperature breaks.
τ is in direct ratio to thermal capacity C of thermistor and in inverse ratio to the dissipation coefficient δ, namely:

$$\tau = \frac{C}{\delta}$$

▲ 电阻-温度特性 Resistance-Temperature Characteristic

热敏电阻器的零功率电阻值与其电阻体温度之间的依赖关系。
The reliant relationship between the zero power resistance of thermistor and its temperature.

▲ R值与B值关系 R-T curve NTC thermisor

热敏电阻器的零功率电阻值与其电阻体温度之间的依赖关系。
The reliant relationship between the zero power resistance of thermistor and its temperature.

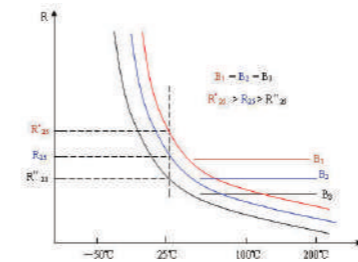

B值相同，阻值不同的R-T特性曲线示意图
R-T curve based on same B value, different resistance

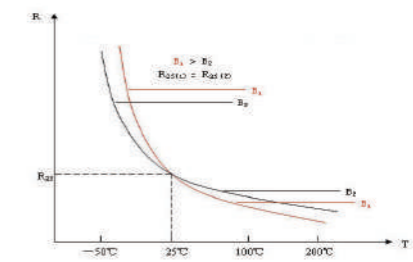

相同阻值，不同B值的R-T特性曲线示意图
R-T curve based on different B value, same resistance

MF72 功率型 直热式负温度系数热敏电阻器 MF72 power direct heat type negative temperature coefficient thermistor

应用 Applications

- ▲ 转换电源, 开关电源, UPS 电源
Switching power-supply, switch power, ups power
- ▲ 镇流器及各类加热器
Electronic energy saving lamps electronic ballast and all kinds of electric heater
- ▲ 各类显像管, 显示器
All kinds of RT, display
- ▲ 电子节能灯, 其他照明灯具
Bulb and other lighting lamps



特点 Characteristic

- ▲ 体积小, 功率大, 抑制浪涌电流能力强
Small size, large power, strong capacity of suppression of inrush current
- ▲ 材料常数 (B 值) 大, 残余电阻小
Big material constant (B value), small residual resistance
- ▲ 系列全, 应用范围宽
Complete series, wide applications
- ▲ 反应速度快
Fast response
- ▲ 寿命长, 可靠性高
Long life and high reliability

MF72 5D Series

引线形状和产品尺寸 Lead Style and Product Size

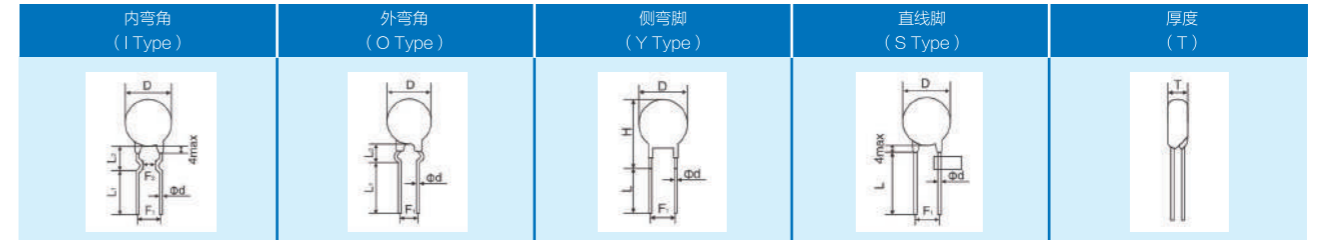

说明: 若非特别指出, 常用外形为内弯型长引线。
Note: if the particular shape, commonly used for bending type, namely the inner-bended forming for long lead

型号	产品形状	最大直径 Dmax	最大厚度 Tmax	引线直径 Φd ± 0.05mm	间距 F ± 1mm	引线长度	
						L min	L 2
NTC □D-5	内弯脚	7mm	5mm	0.55mm	5mm	20mm	7or4
	外弯脚	7mm	5mm	0.55mm	5mm	20mm	7or4
	侧弯脚	7mm	5mm	0.55mm	5mm	20mm	/
	直线脚	7mm	5mm	0.55mm	5mm	20mm	/
NTC □D-7	内弯脚	9mm	5mm	0.55mm	5mm	20mm	7or4
	外弯脚	9mm	5mm	0.55mm	5mm	20mm	7or4
	侧弯脚	9mm	5mm	0.55mm	5mm	20mm	/
	直线脚	9mm	5mm	0.55mm	5mm	20mm	/
NTC □D-9	内弯脚	11mm	5.5mm	0.75/0.55mm	7.5/5mm	20mm	7or4
	外弯脚	11mm	5.5mm	0.75/0.55mm	7.5/5mm	20mm	7or4
	侧弯脚	11mm	5.5mm	0.75/0.55mm	7.5/5mm	20mm	/
	直线脚	11mm	5.5mm	0.75/0.55mm	7.5/5mm	20mm	/
NTC □D-11	内弯脚	13mm	5.5mm	0.75mm	7.5/5mm	20mm	7or4
	外弯脚	13mm	5.5mm	0.75mm	7.5/5mm	20mm	7or4
	侧弯脚	13mm	5.5mm	0.75mm	7.5/5mm	20mm	/
	直线脚	13mm	5.5mm	0.75mm	7.5/5mm	20mm	/
NTC □D-13	内弯脚	15.5mm	6mm	0.75mm	7.5	20mm	7or4
	外弯脚	15.5mm	6mm	0.75mm	7.5	20mm	7or4
	侧弯脚	15.5mm	6mm	0.75mm	7.5	20mm	/
	直线脚	15.5mm	6mm	0.75mm	7.5	20mm	/
NTC □-15	内弯脚	17.5mm	6mm	0.75mm	10/7.5	20mm	7or4
	外弯脚	17.5mm	6mm	0.75mm	10/7.5	20mm	7or4
	侧弯脚	17.5mm	6mm	0.75mm	10/7.5	20mm	/
	直线脚	17.5mm	6mm	0.75mm	10/7.5	20mm	/
NTC □-20	内弯脚	22.5mm	6mm	1mm	10/7.5	20mm	7or4
	外弯脚	22.5mm	6mm	1mm	10/7.5	20mm	7or4
	侧弯脚	22.5mm	6mm	1mm	10/7.5	20mm	/
	直线脚	22.5mm	6mm	1mm	10/7.5	20mm	/

MF72 功率型 直热式负温度系数热敏电阻器 MF72 power direct heat type negative temperature coefficient thermistor

应用 Applications

- ▲ 转换电源, 开关电源, UPS 电源
Switching power-supply, switch power, ups power
- ▲ 镇流器及各类加热器
Electronic energy saving lamps electronic ballast and all kinds of electric heater
- ▲ 各类显像管, 显示器
All kinds of RT, display
- ▲ 电子节能灯, 其他照明灯具
Bulb and other lighting lamps



特点 Characteristic

- ▲ 体积小, 功率大, 抑制浪涌电流能力强
Small size, large power, strong capacity of suppression of inrush current
- ▲ 材料常数 (B 值) 大, 残余电阻小
Big material constant (B value), small residual resistance
- ▲ 系列全, 应用范围宽
Complete series, wide applications
- ▲ 反应速度快
Fast response
- ▲ 寿命长, 可靠性高
Long life and high reliability

MF72 5D Series

引线形状和产品尺寸 Lead Style and Product Size

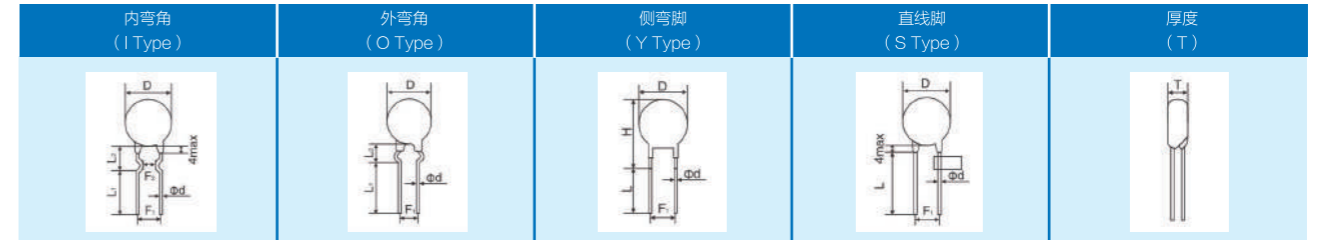

说明: 若非特别指出, 常用外形为内弯型长引线。
Note: if the particular shape, commonly used for bending type, namely the inner-bended forming for long lead

型号	产品形状	最大直径 Dmax	最大厚度 Tmax	引线直径 Φd ± 0.05mm	间距 F ± 1mm	引线长度	
						L min	L 2
NTC □D-5	内弯脚	7mm	5mm	0.55mm	5mm	20mm	7or4
	外弯脚	7mm	5mm	0.55mm	5mm	20mm	7or4
	侧弯脚	7mm	5mm	0.55mm	5mm	20mm	/
	直线脚	7mm	5mm	0.55mm	5mm	20mm	/
NTC □D-7	内弯脚	9mm	5mm	0.55mm	5mm	20mm	7or4
	外弯脚	9mm	5mm	0.55mm	5mm	20mm	7or4
	侧弯脚	9mm	5mm	0.55mm	5mm	20mm	/
	直线脚	9mm	5mm	0.55mm	5mm	20mm	/
NTC □D-9	内弯脚	11mm	5.5mm	0.75/0.55mm	7.5/5mm	20mm	7or4
	外弯脚	11mm	5.5mm	0.75/0.55mm	7.5/5mm	20mm	7or4
	侧弯脚	11mm	5.5mm	0.75/0.55mm	7.5/5mm	20mm	/
	直线脚	11mm	5.5mm	0.75/0.55mm	7.5/5mm	20mm	/
NTC □D-11	内弯脚	13mm	5.5mm	0.75mm	7.5/5mm	20mm	7or4
	外弯脚	13mm	5.5mm	0.75mm	7.5/5mm	20mm	7or4
	侧弯脚	13mm	5.5mm	0.75mm	7.5/5mm	20mm	/
	直线脚	13mm	5.5mm	0.75mm	7.5/5mm	20mm	/
NTC □D-13	内弯脚	15.5mm	6mm	0.75mm	7.5	20mm	7or4
	外弯脚	15.5mm	6mm	0.75mm	7.5	20mm	7or4
	侧弯脚	15.5mm	6mm	0.75mm	7.5	20mm	/
	直线脚	15.5mm	6mm	0.75mm	7.5	20mm	/
NTC □-15	内弯脚	17.5mm	6mm	0.75mm	10/7.5	20mm	7or4
	外弯脚	17.5mm	6mm	0.75mm	10/7.5	20mm	7or4
	侧弯脚	17.5mm	6mm	0.75mm	10/7.5	20mm	/
	直线脚	17.5mm	6mm	0.75mm	10/7.5	20mm	/
NTC □-20	内弯脚	22.5mm	6mm	1mm	10/7.5	20mm	7or4
	外弯脚	22.5mm	6mm	1mm	10/7.5	20mm	7or4
	侧弯脚	22.5mm	6mm	1mm	10/7.5	20mm	/
	直线脚	22.5mm	6mm	1mm	10/7.5	20mm	/

材料

- ①、封装材料 (Wrapper) : 酚醛树脂 (Modified phenolic resin)
- ②、引线 (Down - lead) : CP 线 (CP Wire)
- ③、颜色 (Coating color) : 黑色 (Black)

印字方式

	NTC	负温度系数热敏电阻器NTC thermistor
	□	额定零功率电阻值
	D	圆片型 Disk-Type
	5	直径 6±1(mm)

技术参数 technical parameters

型号 Part No	R25 (Ω)	最大稳态电流 Max.steady State current (A)	残余电阻* Residual Resistance (Ω)	耗散系数* Dissipation factor (mw/°C)	热时间常* Thermal time Constant (s)	最大允许使用容量值 240V/120V(μF)	B值 (K)	工作温度 (°C)
5D-5	5	1	0.35	约6	约20	150/560	2700	-40~+150
8D-5	8	0.7	0.77	约6	约20	100/390	2700	-40~+150
10D-5	10	0.7	0.77	约6	约20	68/270	2700	-40~+150
20D-5	20	0.5	0.997	约6	约20	39/150	2800	-40~+150
33D-5	33	0.5	1.88	约6	约20	39/150	2950	-40~+150
3D-7	3	0.23	0.28	约9	约30	100/390	2600	-40~+150
5D-7	5	2	0.28	约9	约30	100/390	2700	-40~+150
8D-7	8	1	0.77	约9	约30	100/390	2700	-40~+150
10D-7	10	1	0.77	约9	约30	100/390	2700	-40~+150
12D-7	12	1	0.82	约9	约30	82/330	2700	-40~+150
16D-7	16	0.7	1	约9	约30	82/330	2800	-40~+150
20D-7	20	0.6	1.11	约9	约30	82/330	2800	-40~+150
22D-7	22	0.6	1.11	约9	约30	68/270	2800	-40~+150
33D-7	33	0.5	1.49	约9	约30	68/270	2950	-40~+150
2.5D-9	2.5	4	0.11	约11	约35	220/820	2600	-40~+175
3D-9	3	4	0.12	约11	约35	220/820	2600	-40~+175
5D-9	5	3	0.21	约11	约35	220/820	2700	-40~+175
6D-9	6	2	0.32	约11	约35	220/820	2700	-40~+175
8D-9	8	2	0.40	约11	约35	150/560	2700	-40~+175
10D-9	10	2	0.46	约11	约35	150/560	2700	-40~+175
12D-9	12	1	0.66	约11	约35	150/560	2700	-40~+175
15D-9	15	1	0.8	约11	约35	82/330	2800	-40~+175
16D-9	16	1	0.8	约11	约35	82/330	2800	-40~+175
20D-9	20	1	0.88	约11	约35	82/330	2800	-40~+175
22D-9	22	1	0.95	约11	约35	82/330	2800	-40~+175
33D-9	33	1	1.12	约11	约35	68/270	2950	-40~+175
50D-9	50	1	1.25	约11	约35	68/270	2950	-40~+175
100D-9	100	0.8	3.02	约11	约35	68/270	3200	-40~+175
120D-9	120	0.8	3.02	约11	约35	68/270	3200	-40~+175
2.5D-11	2.5	5	0.1	约14	约50	680/2700	2700	-40~+175
3D-11	3	5	0.1	约14	约50	680/2700	2700	-40~+175

技术参数 technical parameters

型号 Part No	R25 (Ω)	最大稳态电流 Max.steady State current (A)	残余电阻* Residual Resistance (Ω)	耗散系数* Dissipation factor (mw/°C)	热时间常* Thermal time Constant (s)	最大允许使用容量值 240V/120V(μF)	B值 (K)	工作温度 (°C)
5D-11	5	4	0.16	约14	约50	470/1800	2700	-40~+175
8D-11	8	3	0.25	约14	约50	470/1800	2800	-40~+175
10D-11	10	3	0.28	约14	约50	220/820	2800	-40~+175
12D-11	12	2	0.46	约14	约50	220/820	2800	-40~+175
15D-11	15	2	0.47	约14	约50	150/560	2800	-40~+175
16D-11	16	2	0.47	约14	约50	150/560	2800	-40~+175
20D-11	20	2	0.51	约14	约50	100/390	2950	-40~+175
22D-11	22	2	0.56	约14	约50	100/390	2950	-40~+175
33D-11	33	1.5	0.67	约14	约50	100/390	2950	-40~+175
47D-11	47	1.5	1.02	约14	约50	100/390	2950	-40~+175
50D-11	50	1.5	1.02	约14	约50	100/390	2950	-40~+175
1.5D-13	1.5	7	0.080	约15	约68	680/2700	2600	-40~+200
2.5D-13	2.5	6	0.088	约15	约68	680/2700	2600	-40~+200
3D-13	3	6	0.092	约15	约68	680/2700	2600	-40~+200
4.7D-13	4.7	5	0.12	约15	约68	680/2700	2700	-40~+200
5D-13	5	5	0.125	约15	约68	680/2700	2700	-40~+200
8D-13	8	4	0.194	约15	约68	330/1200	2800	-40~+200
10D-13	10	4	0.206	约15	约68	330/1200	2800	-40~+200
16D-13	16	3	0.335	约15	约68	220/820	2800	-40~+200
18D-13	18	3	0.372	约15	约68	220/820	2800	-40~+200
20D-13	20	3	0.372	约15	约68	220/820	2800	-40~+200
30D-13	30	2.5	0.517	约15	约68	150/560	2950	-40~+200
47D-13	47	2	0.81	约15	约68	150/560	2950	-40~+200
1D-15	1	8	0.067	约18	约86	820/3300	2600	-40~+200
1.3D-15	1.3	8	0.071	约18	约86	820/3300	2600	-40~+200
1.5D-15	1.5	8	0.071	约18	约86	820/3300	2600	-40~+200
2.5D-15	2.5	8	0.071	约18	约86	820/3300	2600	-40~+200
3D-15	3	7	0.075	约18	约86	820/3300	2600	-40~+200
5D-15	5	6	0.112	约18	约86	680/2700	2800	-40~+200
7D-15	7	5	0.173	约18	约86	680/2700	2800	-40~+200
8D-15	8	5	0.178	约18	约86	680/2700	2950	-40~+200
10D-15	10	5	0.18	约18	约86	560/2200	2950	-40~+200
15D-15	15	4	0.268	约18	约86	560/2200	2950	-40~+200
16D-15	16	4	0.268	约18	约86	560/2200	2950	-40~+200
18D-15	18	4	0.288	约18	约86	330/1200	2950	-40~+200
20D-15	20	4	0.288	约18	约86	220/820	2950	-40~+200
30D-15	30	3.5	0.438	约18	约86	220/820	2950	-40~+200
47D-15	47	3	0.68	约18	约86	220/820	3200	-40~+200
50D-15	50	3	0.72	约18	约86	220/820	3200	-40~+200
0.7D-20	0.7	11	0.018	约24	约89	820/3300	2600	-40~+200
1.3D-20	1.3	9	0.037	约24	约113	820/3300	2600	-40~+200
1.5D-20	1.5	9	0.037	约24	约113	820/3300	2600	-40~+200
2.5D-20	2.5	8	0.055	约24	约113	820/3300	2700	-40~+200
3D-20	3	8	0.055	约24	约113	820/3300	2700	-40~+200
5D-20	5	7	0.087	约24	约113	820/3300	2800	-40~+200
8D-20	8	6	0.142	约24	约113	820/3300	2950	-40~+200
10D-20	10	6	0.162	约24	约113	820/3300	2950	-40~+200
16D-20	16	5	0.212	约24	约113	820/3300	3200	-40~+200
20D-20	20	5	0.212	约24	约113	820/3300	3200	-40~+200

材料

- ①、封装材料 (Wrapper) : 酚醛树脂 (Modified phenolic resin)
- ②、引线 (Down - lead) : CP 线 (CP Wire)
- ③、颜色 (Coating color) : 黑色 (Black)

印字方式

	NTC	负温度系数热敏电阻器NTC thermistor
	□	额定零功率电阻值
	D	圆片型 Disk-Type
	5	直径 6±1(mm)

技术参数 technical parameters

型号 Part No	R25 (Ω)	最大稳态电流 Max.steady State current (A)	残余电阻* Residual Resistance (Ω)	耗散系数* Dissipation factor (mw/°C)	热时间常* Thermal time Constant (s)	最大允许使用容量值 240V/120V(μF)	B值 (K)	工作温度 (°C)
5D-5	5	1	0.35	约6	约20	150/560	2700	-40~+150
8D-5	8	0.7	0.77	约6	约20	100/390	2700	-40~+150
10D-5	10	0.7	0.77	约6	约20	68/270	2700	-40~+150
20D-5	20	0.5	0.997	约6	约20	39/150	2800	-40~+150
33D-5	33	0.5	1.88	约6	约20	39/150	2950	-40~+150
3D-7	3	0.23	0.28	约9	约30	100/390	2600	-40~+150
5D-7	5	2	0.28	约9	约30	100/390	2700	-40~+150
8D-7	8	1	0.77	约9	约30	100/390	2700	-40~+150
10D-7	10	1	0.77	约9	约30	100/390	2700	-40~+150
12D-7	12	1	0.82	约9	约30	82/330	2700	-40~+150
16D-7	16	0.7	1	约9	约30	82/330	2800	-40~+150
20D-7	20	0.6	1.11	约9	约30	82/330	2800	-40~+150
22D-7	22	0.6	1.11	约9	约30	68/270	2800	-40~+150
33D-7	33	0.5	1.49	约9	约30	68/270	2950	-40~+150
2.5D-9	2.5	4	0.11	约11	约35	220/820	2600	-40~+175
3D-9	3	4	0.12	约11	约35	220/820	2600	-40~+175
5D-9	5	3	0.21	约11	约35	220/820	2700	-40~+175
6D-9	6	2	0.32	约11	约35	220/820	2700	-40~+175
8D-9	8	2	0.40	约11	约35	150/560	2700	-40~+175
10D-9	10	2	0.46	约11	约35	150/560	2700	-40~+175
12D-9	12	1	0.66	约11	约35	150/560	2700	-40~+175
15D-9	15	1	0.8	约11	约35	82/330	2800	-40~+175
16D-9	16	1	0.8	约11	约35	82/330	2800	-40~+175
20D-9	20	1	0.88	约11	约35	82/330	2800	-40~+175
22D-9	22	1	0.95	约11	约35	82/330	2800	-40~+175
33D-9	33	1	1.12	约11	约35	68/270	2950	-40~+175
50D-9	50	1	1.25	约11	约35	68/270	2950	-40~+175
100D-9	100	0.8	3.02	约11	约35	68/270	3200	-40~+175
120D-9	120	0.8	3.02	约11	约35	68/270	3200	-40~+175
2.5D-11	2.5	5	0.1	约14	约50	680/2700	2700	-40~+175
3D-11	3	5	0.1	约14	约50	680/2700	2700	-40~+175

技术参数 technical parameters

型号 Part No	R25 (Ω)	最大稳态电流 Max.steady State current (A)	残余电阻* Residual Resistance (Ω)	耗散系数* Dissipation factor (mw/°C)	热时间常* Thermal time Constant (s)	最大允许使用容量值 240V/120V(μF)	B值 (K)	工作温度 (°C)
5D-11	5	4	0.16	约14	约50	470/1800	2700	-40~+175
8D-11	8	3	0.25	约14	约50	470/1800	2800	-40~+175
10D-11	10	3	0.28	约14	约50	220/820	2800	-40~+175
12D-11	12	2	0.46	约14	约50	220/820	2800	-40~+175
15D-11	15	2	0.47	约14	约50	150/560	2800	-40~+175
16D-11	16	2	0.47	约14	约50	150/560	2800	-40~+175
20D-11	20	2	0.51	约14	约50	100/390	2950	-40~+175
22D-11	22	2	0.56	约14	约50	100/390	2950	-40~+175
33D-11	33	1.5	0.67	约14	约50	100/390	2950	-40~+175
47D-11	47	1.5	1.02	约14	约50	100/390	2950	-40~+175
50D-11	50	1.5	1.02	约14	约50	100/390	2950	-40~+175
1.5D-13	1.5	7	0.080	约15	约68	680/2700	2600	-40~+200
2.5D-13	2.5	6	0.088	约15	约68	680/2700	2600	-40~+200
3D-13	3	6	0.092	约15	约68	680/2700	2600	-40~+200
4.7D-13	4.7	5	0.12	约15	约68	680/2700	2700	-40~+200
5D-13	5	5	0.125	约15	约68	680/2700	2700	-40~+200
8D-13	8	4	0.194	约15	约68	330/1200	2800	-40~+200
10D-13	10	4	0.206	约15	约68	330/1200	2800	-40~+200
16D-13	16	3	0.335	约15	约68	220/820	2800	-40~+200
18D-13	18	3	0.372	约15	约68	220/820	2800	-40~+200
20D-13	20	3	0.372	约15	约68	220/820	2800	-40~+200
30D-13	30	2.5	0.517	约15	约68	150/560	2950	-40~+200
47D-13	47	2	0.81	约15	约68	150/560	2950	-40~+200
1D-15	1	8	0.067	约18	约86	820/3300	2600	-40~+200
1.3D-15	1.3	8	0.071	约18	约86	820/3300	2600	-40~+200
1.5D-15	1.5	8	0.071	约18	约86	820/3300	2600	-40~+200
2.5D-15	2.5	8	0.071	约18	约86	820/3300	2600	-40~+200
3D-15	3	7	0.075	约18	约86	820/3300	2600	-40~+200
5D-15	5	6	0.112	约18	约86	680/2700	2800	-40~+200
7D-15	7	5	0.173	约18	约86	680/2700	2800	-40~+200
8D-15	8	5	0.178	约18	约86	680/2700	2950	-40~+200
10D-15	10	5	0.18	约18	约86	560/2200	2950	-40~+200
15D-15	15	4	0.268	约18	约86	560/2200	2950	-40~+200
16D-15	16	4	0.268	约18	约86	560/2200	2950	-40~+200
18D-15	18	4	0.288	约18	约86	330/1200	2950	-40~+200
20D-15	20	4	0.288	约18	约86	220/820	2950	-40~+200
30D-15	30	3.5	0.438	约18	约86	220/820	2950	-40~+200
47D-15	47	3	0.68	约18	约86	220/820	3200	-40~+200
50D-15	50	3	0.72	约18	约86	220/820	3200	-40~+200
0.7D-20	0.7	11	0.018	约24	约89	820/3300	2600	-40~+200
1.3D-20	1.3	9	0.037	约24	约113	820/3300	2600	-40~+200
1.5D-20	1.5	9	0.037	约24	约113	820/3300	2600	-40~+200
2.5D-20	2.5	8	0.055	约24	约113	820/3300	2700	-40~+200
3D-20	3	8	0.055	约24	约113	820/3300	2700	-40~+200
5D-20	5	7	0.087	约24	约113	820/3300	2800	-40~+200
8D-20	8	6	0.142	约24	约113	820/3300	2950	-40~+200
10D-20	10	6	0.162	约24	约113	820/3300	2950	-40~+200
16D-20	16	5	0.212	约24	约113	820/3300	3200	-40~+200
20D-20	20	5	0.212	约24	约113	820/3300	3200	-40~+200

MF52 Pearl-Shape Temp Measurement NTC Thermistor

应用 Applications

- ▲ 空调设备 Air-Conditioner
- ▲ 暖气设备 Heating Apparatus
- ▲ 汽车电子 Automotive electronic
- ▲ 电子体温计 Electric Thermometer
- ▲ 液位传感器 Liquid level sensor
- ▲ 电子台历 Electric table-board
- ▲ 手机电池 Battery of mobile phone

特点 Characteristic

- ▲ 测试精度高 High testing precision
- ▲ 体积小,反应速度快 Small size, Fast Response
- ▲ 互换性,一致性好 Good interchangeability and consistency
- ▲ 能长时间稳定工作 Steady Operating For Long time
- ▲ 规模化生产,性价比高 Scale production, highly cost effective



产品标识说明 Specification

MF52 A 103 G 3380 E

B值允许偏差代号 (根据需标注)
E: ±0.5%, F: ±1%

B值: 为3380K

阻值允许偏差代号: F: ±1%, G: ±2%
H: ±3%, J: ±5%, K: ±10%

标称电阻值: 103为10KΩ

不同外形结构和尺寸代号:
A型引线为镀锡铜线或者镀锡铜包钢线

型号: 珠状精密型NTC热敏电阻器

The allowable tolerance of (label by requirement)
E: ±0.5%, F: ±1%

B value; namely 3380K

Resistance Tolerance Code: Namely F; ±1%, G; ±2%
H; ±3%, J; ±5%, K; ±10%

Rated Resistance: 103 namely 10KΩ

Different Configuration and Code:
Model A is Cu or Cp wire

Type: Temp-measurement chip in glass NTC thermistor

MF52 NTC典型型号

MF52A-103F-3380	MF52A-303J-4200	MF52D-103F-3950	MF52D-503F-3950
MF52A-103F-3950	MF52A-204H-4100	MF52D-103F-3988	MF52C-103F-3950
MF52A-103J-3950	MF52A-102F-3900	MF52D-103G-3435	MF52B-103F-3950
MF52A-104F-3950	MF52A-302F-3900	MF52D-103G-3950	MF52A-103F-3435
MF52A-104J-3950	MF52A-P995F-3900	MF52D-104F-3950	MF52A-104H-4100
MF52A-302J-3950	MF52A-302G-3470	MF52D-104J-3950	MF52A-503F-3950
MF52A-473F-3950	MF52D-103F-3435	MF52D-202F-3470	

主要技术参数 Main Techno-Parameter

Part No.	Rated Resistance R25 (KΩ)	B Value(25/50 °C) (K)	Rated Power (mW)	Dissi.Coef. (mW/°C)	Thermal time Constant(S)	Operating Temp. (°C)
MF52□□□3100	0.1~20	3100	≤50	≥2.0 静止空气中 In still air	≤12 静止空气中 In still air	-40~+125°C
MF52□□□3270	0.2~20	3270				
MF52□□□3380	0.5~50	3380				
MF52□□□3470	0.5~50	3470				
MF52□□□3600	1~100	3600				
MF52□□□3950	5~100	3950				
MF52□□□4000	5~100	4000				
MF52□□□4050	5~200	4050				
MF52□□□4150	10~250	4150				
MF52□□□4300	20~1000	4300				
MF52□□□4500	20~1000	4500				

外形结构和尺寸 Dimensions(mm)

A型: (引线为镀锡铜线或镀锡铜包钢线)
(Tin,nickle Cu or Cp wire)

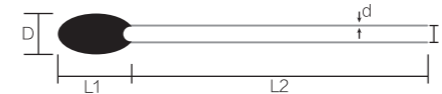

Code	Dmax	L1max	L2min	d ±0.05	F ±0.5
A1	2.5	4.0	25	0.3	1.7
A2	3	4.5	25	0.45	2.2

B型: (引线为锡包线)
(Enamelled ou wire)



Code	Dmax	L1max	L2min	L3 ±1	d ±0.05
B1	2	3.5	用户定制	3	0.2
B2	3	4	用户定制	3	0.3

C型: (引线为高温氟塑线)
(High temp fluorin-plastic wire)

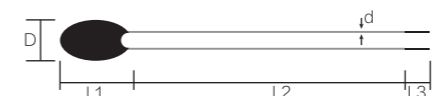

Code	Dmax	L1max	L2min	L3 ±1	d ±0.05
C1	3	7.5	用户定制	5	30#
C2	4	7.5	用户定制	5	28#

D型: (引线为PVC导线)
(PVC Wire)



Code	Dmax	L1max	L2min	L3 ±1	d ±0.05
D1	3	7.5	用户定制	5	30#
D2	4	7.5	用户定制	5	28#

MF52 Pearl-Shape Temp Measurement NTC Thermistor

应用 Applications

- ▲ 空调设备 Air-Conditioner
- ▲ 暖气设备 Heating Apparatus
- ▲ 汽车电子 Automotive electronic
- ▲ 电子体温计 Electric Thermometer
- ▲ 液位传感器 Liquid level sensor
- ▲ 电子台历 Electric table-board
- ▲ 手机电池 Battery of mobile phone

特点 Characteristic

- ▲ 测试精度高 High testing precision
- ▲ 体积小,反应速度快 Small size, Fast Response
- ▲ 能长时间稳定工作 Steady Operating For Long time
- ▲ 互换性,一致性好 Good interchangeability and consistency
- ▲ 规模化生产,性价比高 Scale production, highly cost effective

产品标识说明 Specification

MF52 A 103 G 3380 E

B值允许偏差代号(根据需标注)
E: ±0.5%, F: ±1%

B值: 为3380K

阻值允许偏差代号: F: ±1%, G: ±2%
H: ±3%, J: ±5%, K: ±10%

标称电阻值: 103为10KΩ

不同外形结构和尺寸代号:
A型引线为镀锡铜线或者镀锡铜包钢线

型号: 珠状精密型NTC热敏电阻器

The allowable tolerance of (label by requirement)
E: ±0.5%, F: ±1%

B value; namely 3380K

Resistance Tolerance Code: Namely F; ±1%, G; ±2%
H; ±3%, J; ±5%, K; ±10%

Rated Resistance: 103 namely 10KΩ

Different Configuration and Code:
Model A is Cu or Cp wire

Type: Temp-measurement chip in glass NTC thermistor



MF52 NTC典型型号

MF52A-103F-3380	MF52A-303J-4200	MF52D-103F-3950	MF52D-503F-3950
MF52A-103F-3950	MF52A-204H-4100	MF52D-103F-3988	MF52C-103F-3950
MF52A-103J-3950	MF52A-102F-3900	MF52D-103G-3435	MF52B-103F-3950
MF52A-104F-3950	MF52A-302F-3900	MF52D-103G-3950	MF52A-103F-3435
MF52A-104J-3950	MF52A-P995F-3900	MF52D-104F-3950	MF52A-104H-4100
MF52A-302J-3950	MF52A-302G-3470	MF52D-104J-3950	MF52A-503F-3950
MF52A-473F-3950	MF52D-103F-3435	MF52D-202F-3470	

主要技术参数 Main Techno-Parameter

Part No.	Rated Resistance R25 (KΩ)	B Value(25/50 °C) (K)	Rated Power (mW)	Dissi.Coef. (mW/°C)	Thermal time Constant(S)	Operating Temp. (°C)
MF52□□□3100	0.1~20	3100	≤50	≥2.0 静止空气中 In still air	≤12 静止空气中 In still air	-40~+125°C
MF52□□□3270	0.2~20	3270				
MF52□□□3380	0.5~50	3380				
MF52□□□3470	0.5~50	3470				
MF52□□□3600	1~100	3600				
MF52□□□3950	5~100	3950				
MF52□□□4000	5~100	4000				
MF52□□□4050	5~200	4050				
MF52□□□4150	10~250	4150				
MF52□□□4300	20~1000	4300				
MF52□□□4500	20~1000	4500				

外形结构和尺寸 Dimensions(mm)

A型: (引线为镀锡铜线或镀锡铜包钢线)
(Tin,nickle Cu or Cp wire)

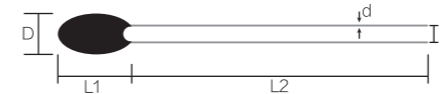

Code	Dmax	L1max	L2min	d ±0.05	F ±0.5
A1	2.5	4.0	25	0.3	1.7
A2	3	4.5	25	0.45	2.2

B型: (引线为锡包线)
(Enamelled ou wire)



Code	Dmax	L1max	L2min	L3 ±1	d ±0.05
B1	2	3.5	用户定制	3	0.2
B2	3	4	用户定制	3	0.3

C型: (引线为高温氟塑线)
(High temp fluorin-plastic wire)

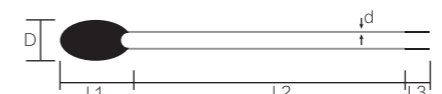

Code	Dmax	L1max	L2min	L3 ±1	d ±0.05
C1	3	7.5	用户定制	5	30#
C2	4	7.5	用户定制	5	28#

D型: (引线为PVC导线)
(PVC Wire)



Code	Dmax	L1max	L2min	L3 ±1	d ±0.05
D1	3	7.5	用户定制	5	30#
D2	4	7.5	用户定制	5	28#

MF58 Glass shell Temp Measurement NTC Thermistor Series

应用 Applications

- ▲ 家用电器（如空调机，微波炉，电磁炉，多士炉，电风扇，电取暖炉等）的温度控制与温度检测
Temperature control and examination of household electrical appliance (such as air-conditioner, microwave oven, induction cooker, toaster fanner, electric heater and so on)
- ▲ 办公自动化设备（如复印机，打印机等）的温度检测或温度补偿
Temperature examination and compensation of the OA equipment (such as copycat, printer and so on)
- ▲ 手机电池，电池组
Battery of mobile telephone, battery pile
- ▲ 仪表线圈，集成电路，石英晶体振荡器和热电偶的温度补偿
Temperature compensation of loops of instrument, integrate circuit, quartz crystal oscillator and thermocouple.



特点 Characteristic

- ▲ 稳定性好，可靠性高 Good stability and security
- ▲ 阻值范围宽，精度高 Broad range of resistance
- ▲ 可在高温和高湿等恶劣环境下使用
Capability of operating in the bad environment of high temperature and high humidity because of glass encapsulation framework.
- ▲ 体积小，重量轻，结构坚固，便于自动化安装
Small size, light weight, strong frame, easy automatic installation (on the printed-circuit board)
- ▲ 热感应快，灵敏度高 Fast response to the temperature, high sensitivity.

主要技术参数 Main techno-parameter

额定零功率电阻值范围 (R25)	R25允许偏差	B值范围 (B25/50°C)	B值允许偏差 (根据需要标注)	耗散系数	热时间常数	工作温度范围	额定功率
0.1~3780KΩ	±1%, ±2% ±3%, ±5% ±10%	3100~4500K	±0.5%, ±1%	≥2mW/°C (在静止空气中)	≤20S (在静止空气中)	-55°C ~ +250°C	≤50mW

产品标识说明 Specification

MF58 502 F 3650 E

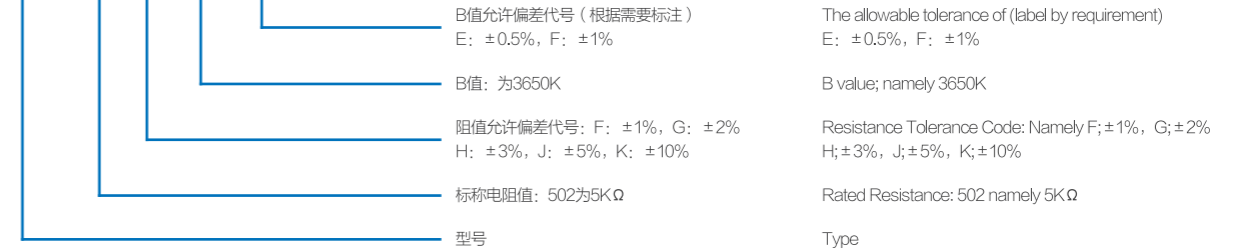

MF58 NTC典型型号

MF58-103G-3600	MF58-203F-3950	MF58-104F-3950	MF58-473F-3950
----------------	----------------	----------------	----------------

外形结构和尺寸 Dimensions(mm)

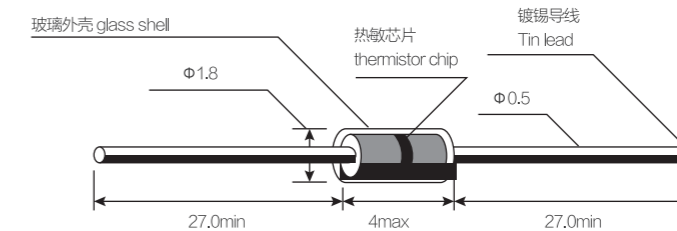

MF58 Glass shell Temp Measurement NTC Thermistor Series

应用 Applications

- ▲ 家用电器（如空调机，微波炉，电磁炉，多士炉，电风扇，电取暖炉等）的温度控制与温度检测
Temperature control and examination of household electrical appliance (such as air-conditioner, microwave oven, induction cooker, toaster fanner, electric heater and so on)
- ▲ 办公自动化设备（如复印机，打印机等）的温度检测或温度补偿
Temperature examination and compensation of the OA equipment (such as copycat, printer and so on)
- ▲ 手机电池，电池组
Battery of mobile telephone, battery pile
- ▲ 仪表线圈，集成电路，石英晶体振荡器和热电偶的温度补偿
Temperature compensation of loops of instrument, integrate circuit, quartz crystal oscillator and thermocouple.



特点 Characteristic

- ▲ 稳定性好，可靠性高 Good stability and security
- ▲ 阻值范围宽，精度高 Broad range of resistance
- ▲ 可在高温和高湿等恶劣环境下使用
Capability of operating in the bad environment of high temperature and high humidity because of glass encapsulation framework.
- ▲ 体积小，重量轻，结构坚固，便于自动化安装
Small size, light weight, strong frame, easy automatic installation (on the printed-circuit board)
- ▲ 热感应快，灵敏度高 Fast response to the temperature, high sensitivity.

主要技术参数 Main techno-parameter

额定零功率电阻值范围 (R25)	R25允许偏差	B值范围 (B25/50°C)	B值允许偏差 (根据需要标注)	耗散系数	热时间常数	工作温度范围	额定功率
0.1~3780KΩ	±1%, ±2% ±3%, ±5% ±10%	3100~4500K	±0.5%, ±1%	≥2mW/°C (在静止空气中)	≤20S (在静止空气中)	-55°C ~ +250°C	≤50mW

产品标识说明 Specification

MF58 502 F 3650 E

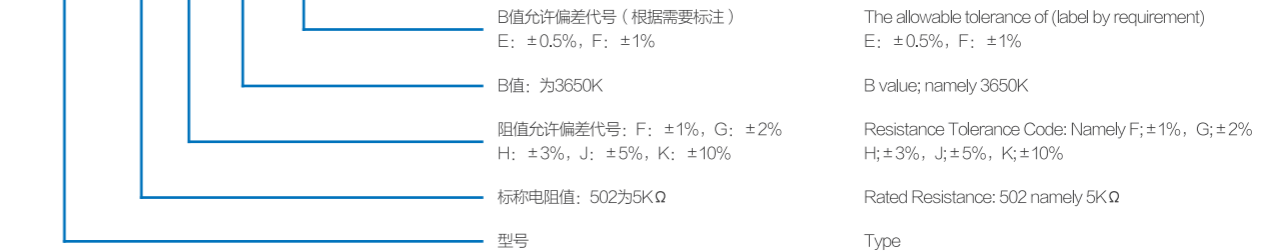

MF58 NTC典型型号

MF58-103G-3600	MF58-203F-3950	MF58-104F-3950	MF58-473F-3950
----------------	----------------	----------------	----------------

外形结构和尺寸 Dimensions(mm)

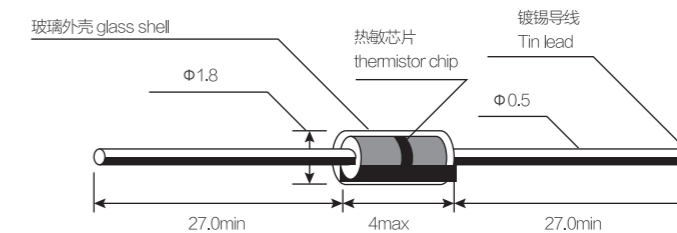

肖特基二极管 SBR (Schottky Barrier Rectifiers)

肖特基二极管是利用金属半导体接触面上形成的势垒具有整流特性而制成的金属-半导体器件。作为低压，高频整流器或者整流桥，极性保护二极管，适用于紧凑型，小型的系统。典型应用于AC-DC和DC-DC转换器，电池极性保护，多种电压“ORing”和其他小尺寸系统的应用。



A Schottky Barrier Rectifier is a metal-semiconductor device fabricated by utilizing a rectifying property of a barrier formed on a metal semiconductor contact surface. This device is suitable for compact and small size systems. Typical for AC-DC and DC-DC converters, battery-polarity protection, multiple voltage ‘ORING’ and other small size systems.

特点 Features

- ▲ 极低正向压降, V_F Very low forward voltage-drop, V_F
- ▲ 因极低正向电压实现高效率 High efficiency due to extremely low forward voltage
- ▲ 高连续电流功能, I_F High continuous current capability, I_F
- ▲ 可节省空间的小型 and 超小型表面贴装封装 Small and ultra small, low profile surface mount package for economic use of space
- ▲ 高峰值电流功能, I_{FSM} High peak current capability, I_{FSM}
- ▲ 卓越的尺寸/性能比, 以及更长的电池使用时间 Excellent size / performance ratio together with extended battery life
- ▲ 低功耗和低发热 Low power dissipation and low heat generation
- ▲ 结合低反向电流的高速开关 High-speed switching combined with low reverse current
- ▲ 耐用的设计和较长的产品使用寿命 Robust designs and long product lifetime

应用 Application

- ▲ 中小功率整流 Low and medium power rectification
- ▲ 电源管理电路, 尤其是DC转DC转换 Power management circuits, especially DC-to-DC conversion
- ▲ 反向极性保护 Reverse polarity protection
- ▲ 低功耗应用 Low power application
- ▲ 用于继电器和电机的电感负载的续流二极管 Free wheeling diode for inductive loads in motors and relays

Definitions and Terms

V_{RRM}	Maximum Recurrent Peak Reverse Voltage
V_{RMS}	Maximum RMS Voltage
V_{DC}	Maximum DC Blocking Voltage
$I_{F(AV)}$	Maximum Average Forward Current at $T_L=75^\circ C$
I_{FSM}	Peak Forward Surge Current :8.3ms single half sine-wave superimposed on rated load (JEDEC method)
V_F	Maximum Forward Voltage at 1.0A
I_R	Maximum DC Reverse Current at Rated DC Blocking Voltage
$R_{\theta JL}$	Typical Thermal Resistance — Junction —to—Lead
$R_{\theta JA}$	Typical Thermal Resistance — Junction —to—Ambient
T_J, T_{STR}	Operating Junction and Storage Temperature Range

- ▲ Features:
 - Metal silicon junction, majority carrier conduction
 - For surface mounted applications
 - Low power loss, high efficiency
 - High forward surge current capability
 - For use in low voltage, high frequency inverters, free wheeling, and polarity protection applications

- ▲ Mechanical Data
 - Case: SOD-123FL
 - Terminals: Solderable per MIL-STD-750, Method 2026

- ▲ Absolute Maximum Ratings and Electrical characteristics
 - Ratings at 25°C ambient temperature unless otherwise specified, Single phase, half wave, 60Hz resistive or inductive load, for capacitive load, derate by 20 %

SOD-123FL 1A Series (DS12 Thru DS120)

Parameter	V_{RRM}	V_{RRS}	V_{DC}	$I_{F(AV)}$	I_{FSM}	V_F	$I_R(25^\circ C)$	$I_R(100^\circ C)$	C_J	$R_{\theta JA}$	T_J	T_{stg}
	V	V	V	A	A	V	mA	mA	pF	°C/W	°C	°C
DS12	20	14	20	1	25	0.55	0.3	10	110	100	-55 ~ +125	-55 ~ +150
DS14	40	28	40	1	25	0.55	0.3	10	110	100	-55 ~ +125	-55 ~ +150
DS16	60	42	60	1	25	0.7	0.3	10	80	100	-55 ~ +125	-55 ~ +150
DS18	80	56	80	1	25	0.7	0.3	10	80	100	-55 ~ +125	-55 ~ +150
DS110	100	70	100	1	25	0.85	0.2	5	80	100	-55 ~ +125	-55 ~ +150
DS112	120	84	120	1	25	0.85	0.2	5	80	100	-55 ~ +125	-55 ~ +150
DS115	150	105	150	1	25	0.9	0.1	2	80	100	-55 ~ +125	-55 ~ +150
DS120	200	140	200	1	25	0.9	0.1	2	80	100	-55 ~ +125	-55 ~ +150

SOD-123FL 2A Series (DS22 Thru DS220)

Parameter	V_{RRM}	V_{RRS}	V_{DC}	$I_{F(AV)}$	I_{FSM}	V_F	$I_R(25^\circ C)$	$I_R(100^\circ C)$	C_J	$R_{\theta JA}$	T_J	T_{stg}
	V	V	V	A	A	V	mA	mA	pF	°C/W	°C	°C
DS22	20	14	20	2	50	0.55	0.5	5	220	85	-55 ~ +125	-55 ~ +150
DS24	40	28	40	2	50	0.55	0.5	5	220	85	-55 ~ +125	-55 ~ +150
DS26	60	42	60	2	50	0.7	0.5	5	80	85	-55 ~ +125	-55 ~ +150
DS28	80	56	80	2	50	0.7	0.3	3	80	85	-55 ~ +125	-55 ~ +150
DS210	100	70	100	2	50	0.85	0.3	3	80	85	-55 ~ +125	-55 ~ +150
DS212	120	84	120	2	50	0.85	0.3	3	80	85	-55 ~ +125	-55 ~ +150
DS215	150	105	150	2	50	0.9	0.3	3	80	85	-55 ~ +125	-55 ~ +150
DS220	200	140	200	2	50	0.9	0.3	3	80	85	-55 ~ +125	-55 ~ +150

肖特基二极管 SBR (Schottky Barrier Rectifiers)

肖特基二极管是利用金属半导体接触面上形成的势垒具有整流特性而制成的金属-半导体器件。作为低压，高频整流器或者整流桥，极性保护二极管，适用于紧凑型，小型的系统。典型应用于AC-DC和DC-DC转换器，电池极性保护，多种电压“ORing”和其他小尺寸系统的应用。



A Schottky Barrier Rectifier is a metal-semiconductor device fabricated by utilizing a rectifying property of a barrier formed on a metal semiconductor contact surface. This device is suitable for compact and small size systems. Typical for AC-DC and DC-DC converters, battery-polarity protection, multiple voltage ‘ORING’ and other small size systems.

特点 Features

- ▲ 极低正向压降, V_F Very low forward voltage-drop, V_F
- ▲ 因极低正向电压实现高效率 High efficiency due to extremely low forward voltage
- ▲ 高连续电流功能, I_F High continuous current capability, I_F
- ▲ 可节省空间的小型 and 超小型表面贴装封装 Small and ultra small, low profile surface mount package for economic use of space
- ▲ 高峰值电流功能, I_{FSM} High peak current capability, I_{FSM}
- ▲ 卓越的尺寸/性能比, 以及更长的电池使用时间 Excellent size / performance ratio together with extended battery life
- ▲ 低功耗和低发热 Low power dissipation and low heat generation
- ▲ 结合低反向电流的高速开关 High-speed switching combined with low reverse current
- ▲ 耐用的设计和较长的产品使用寿命 Robust designs and long product lifetime

应用 Application

- ▲ 中小功率整流 Low and medium power rectification
- ▲ 电源管理电路, 尤其是DC转DC转换 Power management circuits, especially DC-to-DC conversion
- ▲ 反向极性保护 Reverse polarity protection
- ▲ 低功耗应用 Low power application
- ▲ 用于继电器和电机的电感负载的续流二极管 Free wheeling diode for inductive loads in motors and relays

Definitions and Terms

V_{RRM}	Maximum Recurrent Peak Reverse Voltage
V_{RMS}	Maximum RMS Voltage
V_{DC}	Maximum DC Blocking Voltage
$I_{F(AV)}$	Maximum Average Forward Current at $T_L=75^\circ C$
I_{FSM}	Peak Forward Surge Current :8.3ms single half sine-wave superimposed on rated load (JEDEC method)
V_F	Maximum Forward Voltage at 1.0A
I_R	Maximum DC Reverse Current at Rated DC Blocking Voltage
$R_{\theta JL}$	Typical Thermal Resistance — Junction —to—Lead
$R_{\theta JA}$	Typical Thermal Resistance — Junction —to—Ambient
T_J, T_{STR}	Operating Junction and Storage Temperature Range

▲ Features:

- Metal silicon junction, majority carrier conduction
- For surface mounted applications
- Low power loss, high efficiency
- High forward surge current capability
- For use in low voltage, high frequency inverters, free wheeling, and polarity protection applications

▲ Mechanical Data

- Case: SOD-123FL
- Terminals: Solderable per MIL-STD-750, Method 2026

▲ Absolute Maximum Ratings and Electrical characteristics

Ratings at 25°C ambient temperature unless otherwise specified, Single phase, half wave, 60Hz resistive or inductive load, for capacitive load, derate by 20 %

SOD-123FL 1A Series (DS12 Thru DS120)

Parameter	V_{RRM}	V_{RRS}	V_{DC}	$I_{F(AV)}$	I_{FSM}	V_F	$I_R(25^\circ C)$	$I_R(100^\circ C)$	C_J	$R_{\theta JA}$	T_J	T_{stg}
	V	V	V	A	A	V	mA	mA	pF	°C/W	°C	°C
DS12	20	14	20	1	25	0.55	0.3	10	110	100	-55 ~ +125	-55 ~ +150
DS14	40	28	40	1	25	0.55	0.3	10	110	100	-55 ~ +125	-55 ~ +150
DS16	60	42	60	1	25	0.7	0.3	10	80	100	-55 ~ +125	-55 ~ +150
DS18	80	56	80	1	25	0.7	0.3	10	80	100	-55 ~ +125	-55 ~ +150
DS110	100	70	100	1	25	0.85	0.2	5	80	100	-55 ~ +125	-55 ~ +150
DS112	120	84	120	1	25	0.85	0.2	5	80	100	-55 ~ +125	-55 ~ +150
DS115	150	105	150	1	25	0.9	0.1	2	80	100	-55 ~ +125	-55 ~ +150
DS120	200	140	200	1	25	0.9	0.1	2	80	100	-55 ~ +125	-55 ~ +150

SOD-123FL 2A Series (DS22 Thru DS220)

Parameter	V_{RRM}	V_{RRS}	V_{DC}	$I_{F(AV)}$	I_{FSM}	V_F	$I_R(25^\circ C)$	$I_R(100^\circ C)$	C_J	$R_{\theta JA}$	T_J	T_{stg}
	V	V	V	A	A	V	mA	mA	pF	°C/W	°C	°C
DS22	20	14	20	2	50	0.55	0.5	5	220	85	-55 ~ +125	-55 ~ +150
DS24	40	28	40	2	50	0.55	0.5	5	220	85	-55 ~ +125	-55 ~ +150
DS26	60	42	60	2	50	0.7	0.5	5	80	85	-55 ~ +125	-55 ~ +150
DS28	80	56	80	2	50	0.7	0.3	3	80	85	-55 ~ +125	-55 ~ +150
DS210	100	70	100	2	50	0.85	0.3	3	80	85	-55 ~ +125	-55 ~ +150
DS212	120	84	120	2	50	0.85	0.3	3	80	85	-55 ~ +125	-55 ~ +150
DS215	150	105	150	2	50	0.9	0.3	3	80	85	-55 ~ +125	-55 ~ +150
DS220	200	140	200	2	50	0.9	0.3	3	80	85	-55 ~ +125	-55 ~ +150

SOD-123FL 3A Series (DS32 Thru DS320)

Parameter	V _{RRM}	V _{RRS}	V _{DC}	I _{F(AV)}	I _{FSM}	V _F	I _{R(25°C)}	I _{R(100°C)}	C _J	R _{θJA}	T _J	T _{STG}
	V	V	V	A	A	V	mA	mA	pF	°C/W	°C	°C
DS32	20	14	20	3	50	0.55	0.5	10	250	80	-55 ~ +125	-55 ~ +150
DS34	40	28	40	3	50	0.55	0.5	10	250	80	-55 ~ +125	-55 ~ +150
DS36	60	42	60	3	50	0.7	0.3	5	160	80	-55 ~ +125	-55 ~ +150
DS38	80	56	80	3	50	0.7	0.3	5	160	80	-55 ~ +125	-55 ~ +150
DS310	100	70	100	3	50	0.85	0.3	5	160	80	-55 ~ +125	-55 ~ +150
DS312	120	84	120	3	50	0.85	0.3	5	160	80	-55 ~ +125	-55 ~ +150
DS315	150	105	150	3	50	0.95	0.3	5	160	80	-55 ~ +125	-55 ~ +150
DS320	200	140	200	3	50	0.95	0.3	5	160	80	-55 ~ +125	-55 ~ +150

1. Measured at 1 MHz and applied reverse voltage of 4 V D.C
2. P.C.B. mounted with 2.0" X 2.0" (5 X 5 cm) copper pad areas.

Package Outline SOD-123FL

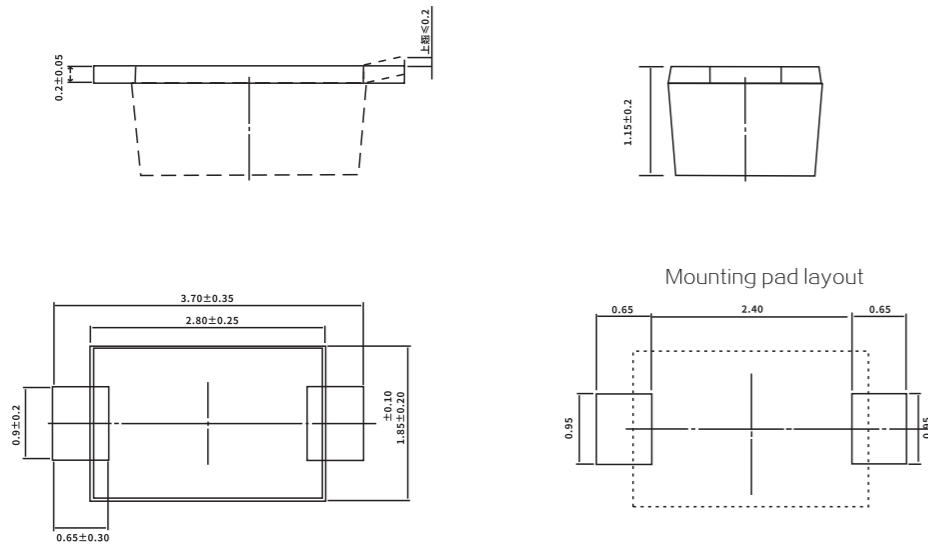

SS12 thru SS120- SMA (1A) Series

Parameter	V _{RRM}	V _{RRS}	V _{DC}	I _{F(AV)}	I _{FSM}	V _F *	I _R (MA)		R _{θJL} *	R _{θJA}	T _J ,T _{STR}
	V	V	V	A	A	V	25°C	100°C	°C/W	°C/W	°C
SS12	20	14	20	1.0	40	0.50	0.2	50	28	88	-55to+125
SS13	30	21	30	1.0	40	0.55	0.2	50	28	88	-55to+125
SS14	40	28	40	1.0	40	0.55	0.05	10	30	88	-55to+125
SS15	50	35	50	1.0	40	0.70	0.05	10	30	88	-65to+125
SS16	60	42	60	1.0	40	0.70	0.05	10	30	88	-65to+125
SS18	80	56	80	1.0	40	0.85	0.05	5	30	88	-65to+125
SS19	90	63	90	1.0	40	0.85	0.05	5	30	88	-65to+125
SS110	100	70	100	1.0	40	0.85	0.05	5	30	88	-65to+125
SS115	150	105	150	1.0	40	0.95	0.02	2	30	88	-65to+125
SS120	200	140	200	1.0	40	0.95	0.02	2	30	88	-65to+125

- NOTES:
 *.Pulse Test with PW = 300 usec ,1% Duty Cycle
 *.Mounted on P.C. Board with 5.0mm2 copper pad areas .

SMA 产品尺寸 (Dimension Unit: mm) Dimensions in inches and (millimeters)

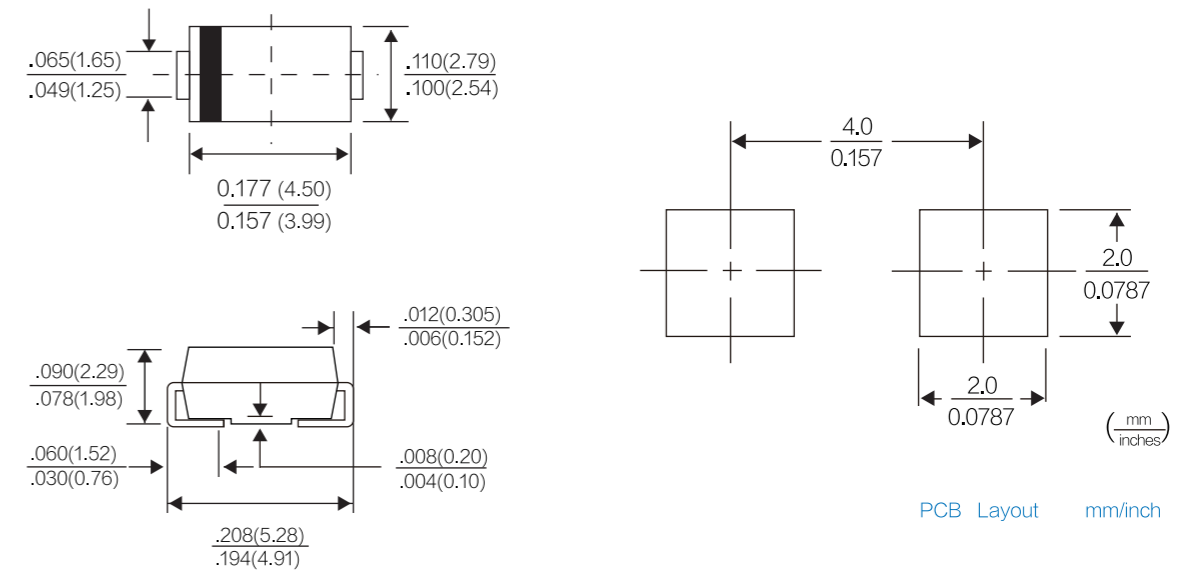

SOD-123FL 3A Series (DS32 Thru DS320)

Parameter	V _{RRM}	V _{RRS}	V _{DC}	I _{F(AV)}	I _{FSM}	V _F	I _{R(25°C)}	I _{R(100°C)}	C _J	R _{θJA}	T _J	T _{stg}
	V	V	V	A	A	V	mA	mA	pF	°C/W	°C	°C
DS32	20	14	20	3	50	0.55	0.5	10	250	80	-55 ~ +125	-55 ~ +150
DS34	40	28	40	3	50	0.55	0.5	10	250	80	-55 ~ +125	-55 ~ +150
DS36	60	42	60	3	50	0.7	0.3	5	160	80	-55 ~ +125	-55 ~ +150
DS38	80	56	80	3	50	0.7	0.3	5	160	80	-55 ~ +125	-55 ~ +150
DS310	100	70	100	3	50	0.85	0.3	5	160	80	-55 ~ +125	-55 ~ +150
DS312	120	84	120	3	50	0.85	0.3	5	160	80	-55 ~ +125	-55 ~ +150
DS315	150	105	150	3	50	0.95	0.3	5	160	80	-55 ~ +125	-55 ~ +150
DS320	200	140	200	3	50	0.95	0.3	5	160	80	-55 ~ +125	-55 ~ +150

1. Measured at 1 MHz and applied reverse voltage of 4 V D.C
2. P.C.B. mounted with 2.0" X 2.0" (5 X 5 cm) copper pad areas.

Package Outline SOD-123FL

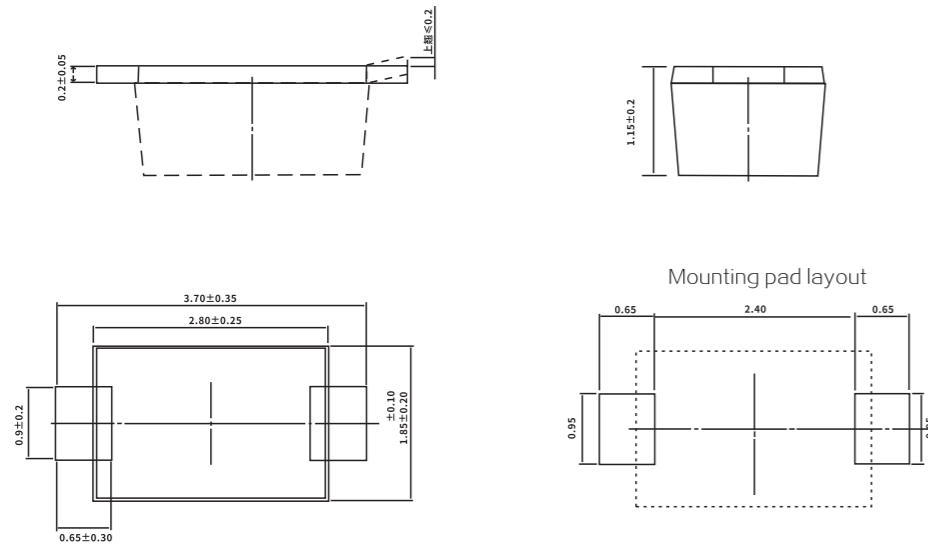

SS12 thru SS120- SMA (1A) Series

Parameter	V _{RRM}	V _{RRS}	V _{DC}	I _{F(AV)}	I _{FSM}	V _F *	I _R (MA)		R _{θJL} *	R _{θJA}	T _J ,T _{STR}
	V	V	V	A	A	V	25°C	100°C	°C/W	°C/W	°C
SS12	20	14	20	1.0	40	0.50	0.2	50	28	88	-55to+125
SS13	30	21	30	1.0	40	0.55	0.2	50	28	88	-55to+125
SS14	40	28	40	1.0	40	0.55	0.05	10	30	88	-55to+125
SS15	50	35	50	1.0	40	0.70	0.05	10	30	88	-65to+125
SS16	60	42	60	1.0	40	0.70	0.05	10	30	88	-65to+125
SS18	80	56	80	1.0	40	0.85	0.05	5	30	88	-65to+125
SS19	90	63	90	1.0	40	0.85	0.05	5	30	88	-65to+125
SS110	100	70	100	1.0	40	0.85	0.05	5	30	88	-65to+125
SS115	150	105	150	1.0	40	0.95	0.02	2	30	88	-65to+125
SS120	200	140	200	1.0	40	0.95	0.02	2	30	88	-65to+125

- NOTES:
 *.Pulse Test with PW = 300 usec ,1% Duty Cycle
 *.Mounted on P.C. Board with 5.0mm2 copper pad areas .

SMA 产品尺寸 (Dimension Unit: mm) Dimensions in inches and (millimeters)

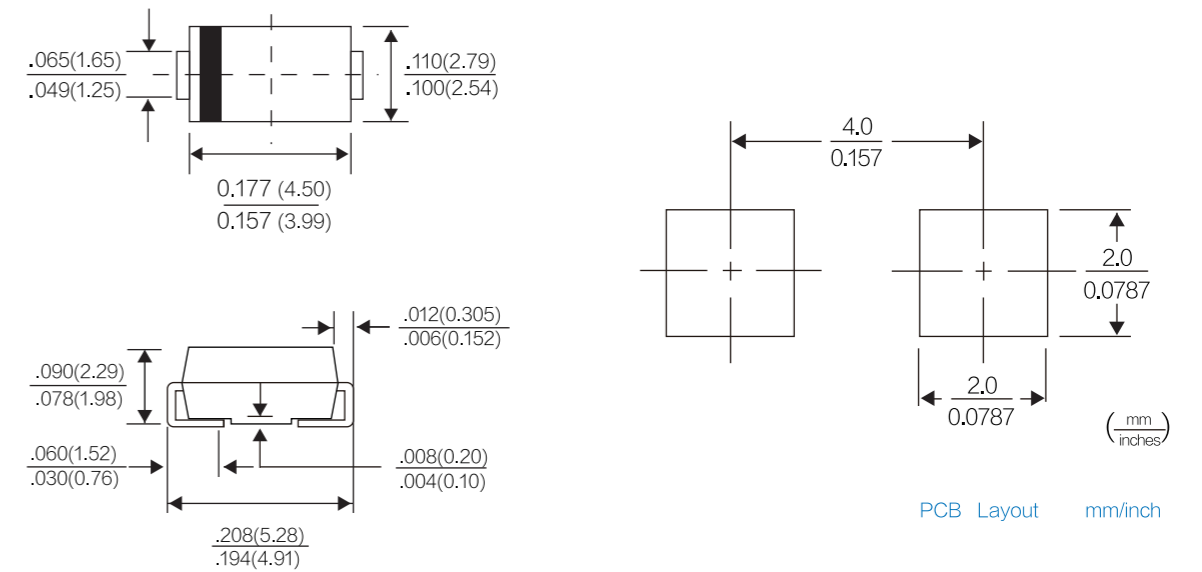

SS22 thru SS220- SMA/SMB (2A) Series



Parameter	V _{RRM} V	V _{RRS} V	V _{DC} V	I _{F(AV)} A	I _{FSM} A	V _F * V	I _R (MA)		R _{θJL} * °C/W	R _{θJA} °C/W	T _J , T _{STR} °C
							25°C	100°C			
SS22	20	14	20	2.0	50	0.50	0.2	20	20	75	-55to+125
SS23	30	21	30	2.0	50	0.55	0.2	20	20	75	-55to+125
SS24	40	28	40	2.0	50	0.55	0.05	20	20	75	-55to+150
SS25	50	35	50	2.0	50	0.70	0.05	20	20	75	-65to+150
SS26	60	42	60	2.0	50	0.70	0.05	20	20	75	-65to+175
SS28	80	56	80	2.0	50	0.85	0.05	20	20	75	-65to+175
SS29	90	63	90	2.0	50	0.85	0.05	20	20	75	-65to+175
SS210	100	70	100	2.0	50	0.85	0.05	20	20	75	-65to+175
SS215	150	105	150	2.0	50	0.95	0.05	20	20	75	-65to+175
SS220	200	140	200	2.0	50	0.95	0.05	20	20	75	-65to+175

NOTES:
 *.Pulse Test with PW = 300 usec ,1% Duty Cycle
 *.Mounted on P.C. Board with8.0mm2 copper pad areas .

SS32 thru SS320- SMA/SMB (3A) Series



Parameter	V _{RRM} V	V _{RRS} V	V _{DC} V	I _{F(AV)} A	I _{FSM} A	V _F * V	I _R (MA)		R _{θJL} * °C/W	R _{θJA} °C/W	T _J , T _{STR} °C
							25°C	100°C			
SS32	20	14	20	3.0	80	0.50	0.2	20	20	75	- 55to+125
SS33	30	21	30	3.0	80	0.55	0.2	20	20	75	- 55to+125
SS34	40	28	40	3.0	80	0.55	0.05	20	20	75	- 55to+150
SS35	50	35	50	3.0	80	0.70	0.05	20	20	75	- 65to+175
SS36	60	42	60	3.0	80	0.70	0.05	20	20	75	- 65to+175
SS38	80	56	80	3.0	80	0.85	0.05	20	20	75	- 65to+175
SS39	90	63	90	3.0	80	0.85	0.05	20	20	75	- 65to+175
SS310	100	70	100	3.0	80	0.85	0.05	20	20	75	- 65to+175
SS315	150	105	150	3.0	80	0.95	0.05	20	20	75	- 65to+175
SS320	200	140	200	3.0	80	0.95	0.05	20	20	75	- 65to+175

NOTES:
 *.Pulse Test with PW = 300 usec ,1% Duty Cycle
 *.Mounted on P.C. Board with8.0mm2 copper pad areas .

SMB 产品尺寸 (Dimension Unit: inch / mm)

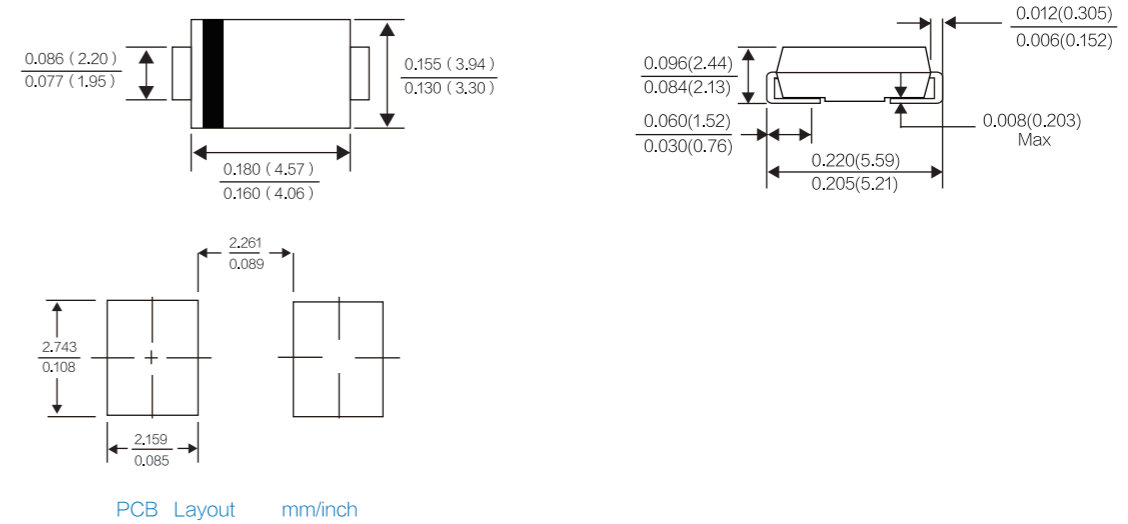

SK32 thru SK320- SMC (3A) Series



Parameter	V _{RRM} V	V _{RRS} V	V _{DC} V	I _{F(AV)} A	I _{FSM} A	V _F * V	I _R (MA)		R _{θJL} * °C/W	R _{θJA} °C/W	T _J , T _{STR} °C
							25°C	100°C			
SK32	20	14	20	3.0	100	0.50	0.2	20	20	75	- 55to+125
SK33	30	21	30	3.0	100	0.55	0.2	20	20	75	- 55to+125
SK34	40	28	40	3.0	100	0.55	0.05	20	20	75	- 55to+150
SK35	50	35	50	3.0	100	0.70	0.05	20	20	75	- 65to+175
SK36	60	42	60	3.0	100	0.70	0.05	20	20	75	- 65to+175
SK38	80	56	80	3.0	100	0.85	0.05	20	20	75	- 65to+175
SK39	90	63	90	3.0	100	0.85	0.05	20	20	75	- 65to+175
SK310	100	70	100	3.0	100	0.85	0.05	20	20	75	- 65to+175
SK315	150	105	150	3.0	100	0.95	0.05	20	20	75	- 65to+175
SK320	200	140	200	3.0	100	0.95	0.05	20	20	75	- 65to+175

NOTES:
 *.Pulse Test with PW = 300 usec ,1% Duty Cycle
 *.Mounted on P.C. Board with8.0mm2 copper pad areas .

SS22 thru SS220- SMA/SMB (2A) Series



Parameter	V _{RRM} V	V _{RRS} V	V _{DC} V	I _{F(AV)} A	I _{FSM} A	V _F * V	I _R (MA)		R _{θJL} * °C/W	R _{θJA} °C/W	T _J , T _{STR} °C
							25°C	100°C			
SS22	20	14	20	2.0	50	0.50	0.2	20	20	75	-55to+125
SS23	30	21	30	2.0	50	0.55	0.2	20	20	75	-55to+125
SS24	40	28	40	2.0	50	0.55	0.05	20	20	75	-55to+150
SS25	50	35	50	2.0	50	0.70	0.05	20	20	75	-65to+150
SS26	60	42	60	2.0	50	0.70	0.05	20	20	75	-65to+175
SS28	80	56	80	2.0	50	0.85	0.05	20	20	75	-65to+175
SS29	90	63	90	2.0	50	0.85	0.05	20	20	75	-65to+175
SS210	100	70	100	2.0	50	0.85	0.05	20	20	75	-65to+175
SS215	150	105	150	2.0	50	0.95	0.05	20	20	75	-65to+175
SS220	200	140	200	2.0	50	0.95	0.05	20	20	75	-65to+175

NOTES:
 *.Pulse Test with PW = 300 usec ,1% Duty Cycle
 *.Mounted on P.C. Board with8.0mm2 copper pad areas .

SS32 thru SS320- SMA/SMB (3A) Series



Parameter	V _{RRM} V	V _{RRS} V	V _{DC} V	I _{F(AV)} A	I _{FSM} A	V _F * V	I _R (MA)		R _{θJL} * °C/W	R _{θJA} °C/W	T _J , T _{STR} °C
							25°C	100°C			
SS32	20	14	20	3.0	80	0.50	0.2	20	20	75	- 55to+125
SS33	30	21	30	3.0	80	0.55	0.2	20	20	75	- 55to+125
SS34	40	28	40	3.0	80	0.55	0.05	20	20	75	- 55to+150
SS35	50	35	50	3.0	80	0.70	0.05	20	20	75	- 65to+175
SS36	60	42	60	3.0	80	0.70	0.05	20	20	75	- 65to+175
SS38	80	56	80	3.0	80	0.85	0.05	20	20	75	- 65to+175
SS39	90	63	90	3.0	80	0.85	0.05	20	20	75	- 65to+175
SS310	100	70	100	3.0	80	0.85	0.05	20	20	75	- 65to+175
SS315	150	105	150	3.0	80	0.95	0.05	20	20	75	- 65to+175
SS320	200	140	200	3.0	80	0.95	0.05	20	20	75	- 65to+175

NOTES:
 *.Pulse Test with PW = 300 usec ,1% Duty Cycle
 *.Mounted on P.C. Board with8.0mm2 copper pad areas .

SMB 产品尺寸 (Dimension Unit: inch / mm)

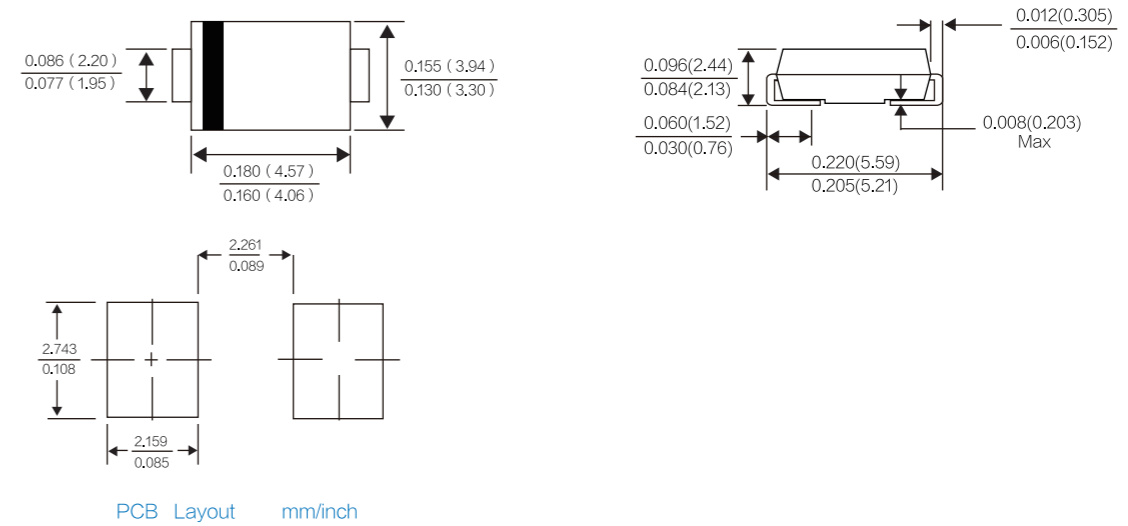

SK32 thru SK320- SMC (3A) Series



Parameter	V _{RRM} V	V _{RRS} V	V _{DC} V	I _{F(AV)} A	I _{FSM} A	V _F * V	I _R (MA)		R _{θJL} * °C/W	R _{θJA} °C/W	T _J , T _{STR} °C
							25°C	100°C			
SK32	20	14	20	3.0	100	0.50	0.2	20	20	75	- 55to+125
SK33	30	21	30	3.0	100	0.55	0.2	20	20	75	- 55to+125
SK34	40	28	40	3.0	100	0.55	0.05	20	20	75	- 55to+150
SK35	50	35	50	3.0	100	0.70	0.05	20	20	75	- 65to+175
SK36	60	42	60	3.0	100	0.70	0.05	20	20	75	- 65to+175
SK38	80	56	80	3.0	100	0.85	0.05	20	20	75	- 65to+175
SK39	90	63	90	3.0	100	0.85	0.05	20	20	75	- 65to+175
SK310	100	70	100	3.0	100	0.85	0.05	20	20	75	- 65to+175
SK315	150	105	150	3.0	100	0.95	0.05	20	20	75	- 65to+175
SK320	200	140	200	3.0	100	0.95	0.05	20	20	75	- 65to+175

NOTES:
 *.Pulse Test with PW = 300 usec ,1% Duty Cycle
 *.Mounted on P.C. Board with8.0mm2 copper pad areas .



SK52 thru SK520- SMC (5A) Series

Parameter	V _{RRM} V	V _{RRS} V	V _{DC} V	I _{F(AV)} A	I _{FSM} A	V _F [*] V	I _R (mA)		R _{θJL} [*]	R _{θJA}	T _J , T _{STR}
							25°C	100°C	°C/W	°C/W	°C
SK52	20	14	20	5.0	100	0.50	0.2	20	17	55	- 55to+125
SK53	30	21	30	5.0	100	0.55	0.2	20	17	55	- 55to+125
SK54	40	28	40	5.0	100	0.55	0.05	10	17	55	- 55to+150
SK55	50	35	50	5.0	100	0.70	0.05	10	17	55	- 65to+175
SK56	60	42	60	5.0	100	0.70	0.05	10	17	55	- 65to+175
SK58	80	56	80	5.0	100	0.85	0.05	10	17	55	- 65to+175
SK59	90	63	90	5.0	100	0.85	0.05	10	17	55	- 65to+175
SK510	100	70	100	5.0	100	0.85	0.05	10	17	55	- 65to+175
SK515	150	105	150	5.0	100	0.95	0.05	10	17	55	- 65to+175
SK520	200	140	200	5.0	100	0.95	0.05	10	17	55	- 65to+175

NOTES:
 *.Pulse Test with PW = 300 usec ,1% Duty Cycle
 *.Mounted on P.C. Board with 8.0mm² copper pad areas

SMC/DO-214AB 产品尺寸 (Dimension Unit: mm) Dimensions in inches and (millimeters)

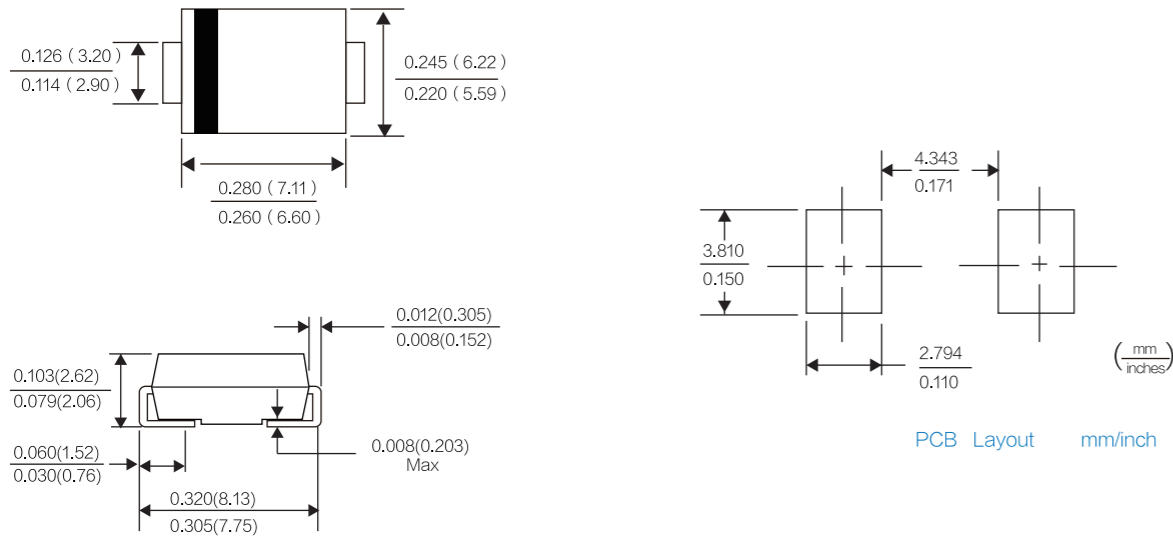

PCB Layout mm/inch



BAT54- SOT23 Series

PARAMETER	SYMBOL	BAT54	BAT54A	BAT54C	BAT54S	UNITS
Forward Power Dissipation@T _A =25°C	P _D		225			mW
Repetitive Peak Reverse Voltage	V _{RRM}		30			V
Maximum Average Forward Current at T _L =75 °C	I _{F(AV)}		0.2			A
Repetitive Peak Forward Current (T _P =8.3ms .50% Duty Cycle)	I _{FRM}		300			mA
Peak Forward Surge Current 1.0s (JEDEC method)	I _{FSM}		0.6			A
Maximum Instantaneous Forward Voltage @I _F =1mA , @I _F =100mA	V _F		0.32	0.8		V
Maximum DC Reverse Current at Rated DC Blocking Voltage@V _R =25V	I _R		2.0			uA
Thermal Resistance , Junction to Ambient	R _{θJA}		500			°C/W
Junction Capacitance @ V _R =1V	C _J		10			PF
Operating Junction and Storage Temperature Range	T _J , T _{STR}		-55 to +125			°C

Circuit

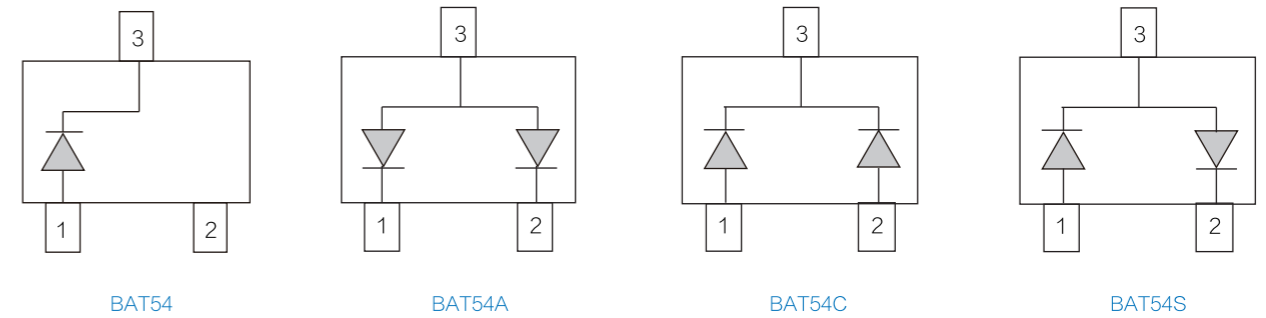



SK52 thru SK520- SMC (5A) Series

Parameter	V _{RRM} V	V _{RRS} V	V _{DC} V	I _{F(AV)} A	I _{FSM} A	V _F [*] V	I _R (mA)		R _{θJL} [*]	R _{θJA}	T _J , T _{STR}
							25°C	100°C	°C/W	°C/W	°C
SK52	20	14	20	5.0	100	0.50	0.2	20	17	55	- 55to+125
SK53	30	21	30	5.0	100	0.55	0.2	20	17	55	- 55to+125
SK54	40	28	40	5.0	100	0.55	0.05	10	17	55	- 55to+150
SK55	50	35	50	5.0	100	0.70	0.05	10	17	55	- 65to+175
SK56	60	42	60	5.0	100	0.70	0.05	10	17	55	- 65to+175
SK58	80	56	80	5.0	100	0.85	0.05	10	17	55	- 65to+175
SK59	90	63	90	5.0	100	0.85	0.05	10	17	55	- 65to+175
SK510	100	70	100	5.0	100	0.85	0.05	10	17	55	- 65to+175
SK515	150	105	150	5.0	100	0.95	0.05	10	17	55	- 65to+175
SK520	200	140	200	5.0	100	0.95	0.05	10	17	55	- 65to+175

NOTES:
 *.Pulse Test with PW = 300 usec ,1% Duty Cycle
 *.Mounted on P.C. Board with 8.0mm² copper pad areas

SMC/DO-214AB 产品尺寸 (Dimension Unit: mm) Dimensions in inches and (millimeters)

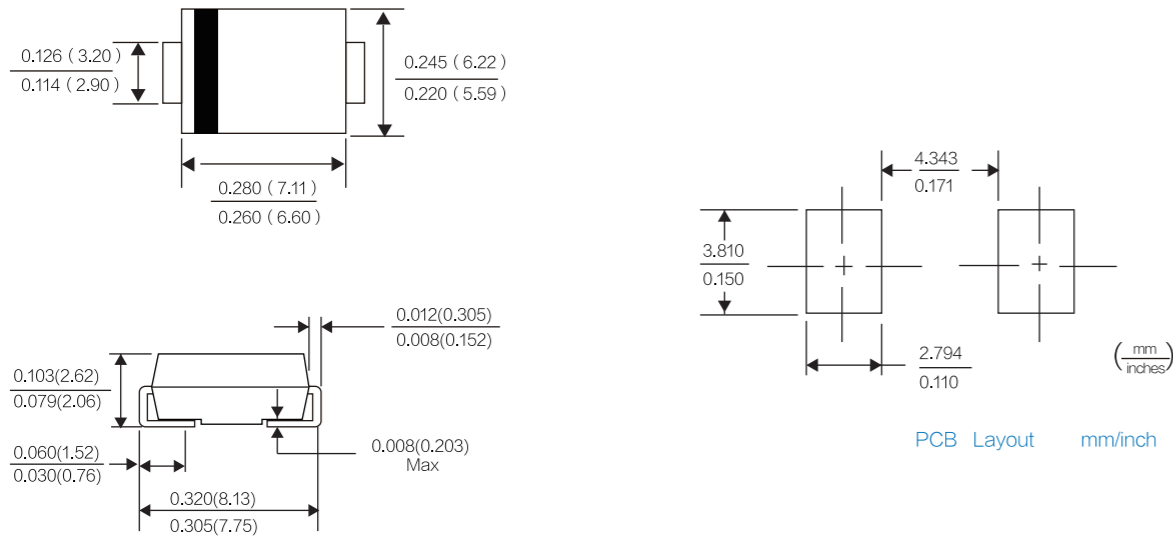

PCB Layout mm/inch



BAT54- SOT23 Series

PARAMETER	SYMBOL	BAT54	BAT54A	BAT54C	BAT54S	UNITS
Forward Power Dissipation@T _A =25°C	P _D		225			mW
Repetitive Peak Reverse Voltage	V _{RRM}		30			V
Maximum Average Forward Current at T _L =75 °C	I _{F(AV)}		0.2			A
Repetitive Peak Forward Current (T _P =8.3ms .50% Duty Cycle)	I _{FRM}		300			mA
Peak Forward Surge Current 1.0s (JEDEC method)	I _{FSM}		0.6			A
Maximum Instantaneous Forward Voltage @I _F =1mA , @I _F =100mA	V _F		0.32	0.8		V
Maximum DC Reverse Current at Rated DC Blocking Voltage@V _R =25V	I _R		2.0			uA
Thermal Resistance , Junction to Ambient	R _{θJA}		500			°C/W
Junction Capacitance @ V _R =1V	C _J		10			PF
Operating Junction and Storage Temperature Range	T _J , T _{STR}		-55 to +125			°C

Circuit

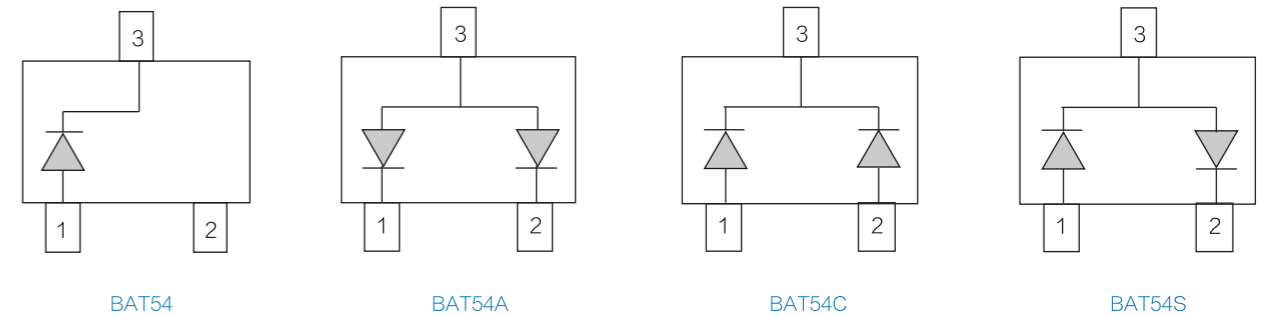

High Current Schottky

Voltage	Part Name	I _F (AV)	V _{RRM}	Max V _F	Max	I _{FSM}	T _J	Package
		A	V	V	IR(μA)	A	°C	
45	HLS1045K	5 × 2	45	0.58	50	150	175	TO-252,TO-251
	HLS2045K	10 × 2	45	0.68	50	200	175	TO-252,TO-251
	HLS3045K	15 × 2	45	0.65	50	275	175	TO-220, TO-263,TO-220F, TO-262
	HLS1545N2	15	45	0.65	50	275	175	TO-220-2
	HLS4045K	20 × 2	45	0.67	50	300	175	TO-220, TO-263,TO-220F, TO-262
	HLS2045N2	20	45	0.67	50	300	175	TO-220-2
60	HLS6045K	30 × 2	45	0.67	50	350	175	TO-247,TO-3P
	HLS1060K	5 × 2	60	0.7	50	150	175	TO-252,TO-251
	HLS2060K	10 × 2	60	0.76	50	200	175	TO-252,TO-251
	HLS3060K	15 × 2	60	0.85	50	275	175	TO-220, TO-263,TO-220F, TO-262
	HLS1560N2	15	60	0.85	50	275	175	TO-220-2
	HLS4060K	20 × 2	60	0.85	50	300	175	TO-220, TO-263,TO-220F, TO-262
	HLS2060N2	20	60	0.85	50	300	175	TO-220-2
	HLS6060K	30 × 2	60	0.85	50	350	175	TO-247,TO-3P
	HLS8060K	40 × 2	60	0.85	50	420	175	TO-247,TO-3P
	HLS10100K	5 × 2	100	0.83	50	150	175	TO-252,TO-251
100	HLS20100K	10 × 2	100	0.75	50	200	175	TO-220, TO-263,TO-220F, TO-262
	HLS30100K	15 × 2	100	0.9	50	275	175	TO-220, TO-263,TO-220F, TO-262
	HLS15100N2	15	100	0.9	50	275	175	TO-220-2
	HLS40100K	20 × 2	100	0.9	50	300	175	TO-220, TO-263,TO-220F, TO-262
	HLS20100N2	20	100	0.9	50	300	175	TO-220-2
	HLS60100K	30 × 2	100	0.9	50	350	175	TO-3P, TO-247
	HLS80100K	40 × 2	100	0.9	50	420	175	TO-3P, TO-247
	HLS10150K	5 × 2	150	0.9	50	150	175	TO-252,TO-251
150	HLS20150K	10 × 2	150	0.9	50	200	175	TO-220, TO-263,TO-220F, TO-262
	HLS30150K	15 × 2	150	0.9	50	275	175	TO-220, TO-263,TO-220F, TO-262
	HLS15150N2	15	150	0.9	50	275	175	TO-220-2
	HLS40150K	20 × 2	150	0.9	50	300	175	TO-220, TO-263,TO-220F, TO-262
	HLS20150N2	20	150	0.9	50	300	175	TO-220-2
	HLS60150K	30 × 2	150	0.9	50	350	175	TO-3P, TO-247
	HLS80150K	40 × 2	150	0.9	50	420	175	TO-3P, TO-247
	HLS10200K	5 × 2	200	0.93	50	150	175	TO-252,TO-251
200	HLS20200K	10 × 2	200	0.93	50	200	175	TO-220, TO-263,TO-220F, TO-262
	HLS30200K	15 × 2	200	0.93	50	275	175	TO-220, TO-263,TO-220F, TO-262
	HLS15200N2	15	200	0.93	50	275	175	TO-220-2
	HLS40200K	20 × 2	200	0.93	50	300	175	TO-220, TO-263,TO-220F, TO-262
	HLS20200N2	20	200	0.93	50	300	175	TO-220-2
	HLS60200K	30 × 2	200	0.93	50	350	175	TO-3P, TO-247
	HLS80200K	40 × 2	200	0.93	50	420	175	TO-3P, TO-247

整流二极管 (Rectifier Diode)

整流二极管是利用PN结的单向导电特性，把交流电变成脉动直流电的半导体器件。选用整流二极管时，主要应考虑其最大整流电流、最大反向工作电流、截止频率及反向恢复时间等参数。

The rectifier diode is a semiconductor device that utilizes the unilateral conductivity of the PN junction to convert the alternating current into a pulsating direct current. When choosing a rectifier diode, the parameters such as maximum rectification current, maximum reverse operating current, cut-off frequency, and reverse recovery time should be considered.

根据芯片工艺不同，反向恢复时间也不同，通常分为四大类：

- 1、普通整流二极管，反向恢复时间大于 500ns（纳秒）；
- 2、快恢复整流二极管，反向恢复时间 150-500ns（纳秒）；
- 3、高效率整流二极管，反向恢复时间 50-100ns（纳秒）；
- 4、超快速整流二极管，反向恢复时间 15-35ns（纳秒）

The reverse recovery time of rectifier diode could be divided into four categories due to different chip technologies:

1. The reverse recovery time of standard rectifier diode: > 500ns (nanoseconds);
2. The reverse recovery time of fast recovery rectifier diode: 150-500ns (nanoseconds);
3. The reverse recovery time of high efficiency rectifier diode: 50-100ns (nanoseconds);
4. The reverse recovery time of super fast recovery rectifier diode: 15-35ns (nanoseconds).

普通整流二极管 (Standard Rectifier Diode)

Type	Package outline	I _O	V _{RRM}	I _{FSM}	V _F		I _R	
		A	V	A	V	I _F (A)	μA	V _R (V)
1N4001W	SOD-123FL	1	50	30	1.1	1	5	50
1N4002W	SOD-123FL	1	100	30	1.1	1	5	100
1N4003W	SOD-123FL	1	200	30	1.1	1	5	200
1N4004W	SOD-123FL	1	400	30	1.1	1	5	400
1N4005W	SOD-123FL	1	600	30	1.1	1	5	600
1N4006W	SOD-123FL	1	800	30	1.1	1	5	800
1N4007W	SOD-123FL	1	1000	30	1.1	1	5	1000
S1AF	SMAF	1	50	30	1.1	1	5	50
S1BF	SMAF	1	100	30	1.1	1	5	100
S1DF	SMAF	1	200	30	1.1	1	5	200
S1GF	SMAF	1	400	30	1.1	1	5	400
S1JF	SMAF	1	600	30	1.1	1	5	600
S1KF	SMAF	1	800	30	1.1	1	5	800
S1MF	SMAF	1	1000	30	1.1	1	5	1000
S2AF	SMAF	2	50	50	1.1	2	5	50
S2BF	SMAF	2	100	50	1.1	2	5	100
S2DF	SMAF	2	200	50	1.1	2	5	200
S2GF	SMAF	2	400	50	1.1	2	5	400
S2JF	SMAF	2	600	50	1.1	2	5	600
S2KF	SMAF	2	800	50	1.1	2	5	800
S2MF	SMAF	2	1000	50	1.1	2	5	1000
S3AF	SMAF	3	50	80	1.1	3	5	50
S3BF	SMAF	3	100	80	1.1	3	5	100
S3DF	SMAF	3	200	80	1.1	3	5	200
S3GF	SMAF	3	400	80	1.1	3	5	400
S3JF	SMAF	3	600	80	1.1	3	5	600
S3KF	SMAF	3	800	80	1.1	3	5	800

High Current Schottky

Voltage	Part Name	I _F (AV)	V _{RRM}	Max V _F	Max	I _{FSM}	T _J	Package
		A	V	V	IR(μA)	A	°C	
45	HLS1045K	5 × 2	45	0.58	50	150	175	TO-252,TO-251
	HLS2045K	10 × 2	45	0.68	50	200	175	TO-252,TO-251
	HLS3045K	15 × 2	45	0.65	50	275	175	TO-220, TO-263,TO-220F, TO-262
	HLS1545N2	15	45	0.65	50	275	175	TO-220-2
	HLS4045K	20 × 2	45	0.67	50	300	175	TO-220, TO-263,TO-220F, TO-262
	HLS2045N2	20	45	0.67	50	300	175	TO-220-2
60	HLS6045K	30 × 2	45	0.67	50	350	175	TO-247,TO-3P
	HLS1060K	5 × 2	60	0.7	50	150	175	TO-252,TO-251
	HLS2060K	10 × 2	60	0.76	50	200	175	TO-252,TO-251
	HLS3060K	15 × 2	60	0.85	50	275	175	TO-220, TO-263,TO-220F, TO-262
	HLS1560N2	15	60	0.85	50	275	175	TO-220-2
	HLS4060K	20 × 2	60	0.85	50	300	175	TO-220, TO-263,TO-220F, TO-262
	HLS2060N2	20	60	0.85	50	300	175	TO-220-2
	HLS6060K	30 × 2	60	0.85	50	350	175	TO-247,TO-3P
	HLS8060K	40 × 2	60	0.85	50	420	175	TO-247,TO-3P
	HLS10100K	5 × 2	100	0.83	50	150	175	TO-252,TO-251
100	HLS20100K	10 × 2	100	0.75	50	200	175	TO-220, TO-263,TO-220F, TO-262
	HLS30100K	15 × 2	100	0.9	50	275	175	TO-220, TO-263,TO-220F, TO-262
	HLS15100N2	15	100	0.9	50	275	175	TO-220-2
	HLS40100K	20 × 2	100	0.9	50	300	175	TO-220, TO-263,TO-220F, TO-262
	HLS20100N2	20	100	0.9	50	300	175	TO-220-2
	HLS60100K	30 × 2	100	0.9	50	350	175	TO-3P, TO-247
	HLS80100K	40 × 2	100	0.9	50	420	175	TO-3P, TO-247
	HLS10150K	5 × 2	150	0.9	50	150	175	TO-252,TO-251
150	HLS20150K	10 × 2	150	0.9	50	200	175	TO-220, TO-263,TO-220F, TO-262
	HLS30150K	15 × 2	150	0.9	50	275	175	TO-220, TO-263,TO-220F, TO-262
	HLS15150N2	15	150	0.9	50	275	175	TO-220-2
	HLS40150K	20 × 2	150	0.9	50	300	175	TO-220, TO-263,TO-220F, TO-262
	HLS20150N2	20	150	0.9	50	300	175	TO-220-2
	HLS60150K	30 × 2	150	0.9	50	350	175	TO-3P, TO-247
	HLS80150K	40 × 2	150	0.9	50	420	175	TO-3P, TO-247
	HLS10200K	5 × 2	200	0.93	50	150	175	TO-252,TO-251
200	HLS20200K	10 × 2	200	0.93	50	200	175	TO-220, TO-263,TO-220F, TO-262
	HLS30200K	15 × 2	200	0.93	50	275	175	TO-220, TO-263,TO-220F, TO-262
	HLS15200N2	15	200	0.93	50	275	175	TO-220-2
	HLS40200K	20 × 2	200	0.93	50	300	175	TO-220, TO-263,TO-220F, TO-262
	HLS20200N2	20	200	0.93	50	300	175	TO-220-2
	HLS60200K	30 × 2	200	0.93	50	350	175	TO-3P, TO-247
	HLS80200K	40 × 2	200	0.93	50	420	175	TO-3P, TO-247

整流二极管 (Rectifier Diode)

整流二极管是利用PN结的单向导电特性，把交流电变成脉动直流电的半导体器件。选用整流二极管时，主要应考虑其最大整流电流、最大反向工作电流、截止频率及反向恢复时间等参数。

The rectifier diode is a semiconductor device that utilizes the unilateral conductivity of the PN junction to convert the alternating current into a pulsating direct current. When choosing a rectifier diode, the parameters such as maximum rectification current, maximum reverse operating current, cut-off frequency, and reverse recovery time should be considered.

根据芯片工艺不同，反向恢复时间也不同，通常分为四大类：

- 1、普通整流二极管，反向恢复时间大于 500ns（纳秒）；
- 2、快恢复整流二极管，反向恢复时间 150-500ns（纳秒）；
- 3、高效率整流二极管，反向恢复时间 50-100ns（纳秒）；
- 4、超快速整流二极管，反向恢复时间 15-35ns（纳秒）

The reverse recovery time of rectifier diode could be divided into four categories due to different chip technologies:

1. The reverse recovery time of standard rectifier diode: > 500ns (nanoseconds);
2. The reverse recovery time of fast recovery rectifier diode: 150-500ns (nanoseconds);
3. The reverse recovery time of high efficiency rectifier diode: 50-100ns (nanoseconds);
4. The reverse recovery time of super fast recovery rectifier diode: 15-35ns (nanoseconds).

普通整流二极管 (Standard Rectifier Diode)

Type	Package outline	I _O	V _{RRM}	I _{FSM}	V _F		I _R	
		A	V	A	V	I _F (A)	μA	V _R (V)
1N4001W	SOD-123FL	1	50	30	1.1	1	5	50
1N4002W	SOD-123FL	1	100	30	1.1	1	5	100
1N4003W	SOD-123FL	1	200	30	1.1	1	5	200
1N4004W	SOD-123FL	1	400	30	1.1	1	5	400
1N4005W	SOD-123FL	1	600	30	1.1	1	5	600
1N4006W	SOD-123FL	1	800	30	1.1	1	5	800
1N4007W	SOD-123FL	1	1000	30	1.1	1	5	1000
S1AF	SMAF	1	50	30	1.1	1	5	50
S1BF	SMAF	1	100	30	1.1	1	5	100
S1DF	SMAF	1	200	30	1.1	1	5	200
S1GF	SMAF	1	400	30	1.1	1	5	400
S1JF	SMAF	1	600	30	1.1	1	5	600
S1KF	SMAF	1	800	30	1.1	1	5	800
S1MF	SMAF	1	1000	30	1.1	1	5	1000
S2AF	SMAF	2	50	50	1.1	2	5	50
S2BF	SMAF	2	100	50	1.1	2	5	100
S2DF	SMAF	2	200	50	1.1	2	5	200
S2GF	SMAF	2	400	50	1.1	2	5	400
S2JF	SMAF	2	600	50	1.1	2	5	600
S2KF	SMAF	2	800	50	1.1	2	5	800
S2MF	SMAF	2	1000	50	1.1	2	5	1000
S3AF	SMAF	3	50	80	1.1	3	5	50
S3BF	SMAF	3	100	80	1.1	3	5	100
S3DF	SMAF	3	200	80	1.1	3	5	200
S3GF	SMAF	3	400	80	1.1	3	5	400
S3JF	SMAF	3	600	80	1.1	3	5	600
S3KF	SMAF	3	800	80	1.1	3	5	800

快恢复二极管 (Fast Recovery Rectifier Diode)

Type	Package outline	I _o	V _{RRM}	I _{FSM}	V _F		I _R		T _{RR}
		A	V	A	V	I _F (A)	μA	V _R (V)	ns
RS2D	SMA	2	200	50	1.3	2	5	200	150
RS2G	SMA	2	400	50	1.3	2	5	400	150
RS2J	SMA	2	600	50	1.3	2	5	600	250
RS2K	SMA	2	800	50	1.3	2	5	800	500
RS2M	SMA	2	1000	50	1.3	2	5	1000	500
RS2AB	SMB	2	50	50	1.3	2	5	50	150
RS2BB	SMB	2	100	50	1.3	2	5	100	150
RS2DB	SMB	2	200	50	1.3	2	5	200	150
RS2GB	SMB	2	400	50	1.3	2	5	400	150
RS2JB	SMB	2	600	50	1.3	2	5	600	250
RS2KB	SMB	2	800	50	1.3	2	5	800	500
RS2MB	SMB	2	1000	50	1.3	2	5	1000	500
RS3AB	SMB	3	50	80	1.3	3	5	50	150
RS3BB	SMB	3	100	80	1.3	3	5	100	150
RS3DB	SMB	3	200	80	1.3	3	5	200	150
RS3GB	SMB	3	400	80	1.3	3	5	400	150
RS3JB	SMB	3	600	80	1.3	3	5	600	250
RS3KB	SMB	3	800	80	1.3	3	5	800	500
RS3MB	SMB	3	1000	80	1.3	3	5	1000	500
RS3AC	SMC	3	50	80	1.3	3	5	50	150
RS3BC	SMC	3	100	80	1.3	3	5	100	150
RS3DC	SMC	3	200	80	1.3	3	5	200	150
RS3GC	SMC	3	400	80	1.3	3	5	400	150
RS3JC	SMC	3	600	80	1.3	3	5	600	250
RS3KC	SMC	3	800	80	1.3	3	5	800	500
RS3MC	SMC	3	1000	80	1.3	3	5	1000	500
RS5AC	SMC	5	50	100	1.3	5	5	50	150
RS5BC	SMC	5	100	100	1.3	5	5	100	150
RS5DC	SMC	5	200	100	1.3	5	5	200	150
RS5GC	SMC	5	400	100	1.3	5	5	400	150
RS5JC	SMC	5	600	100	1.3	5	5	600	250
RS5KC	SMC	5	800	100	1.3	5	5	800	500
RS5MC	SMC	5	1000	100	1.3	5	5	1000	500

高效整流二极管 (High Efficiency Rectifier Diode)



Type	Package outline	I _o	V _{RRM}	I _{FSM}	V _F		I _R		T _{RR}
		A	V	A	V	I _F (A)	μA	V _R (V)	ns
US1AW	SOD-123FL	1	50	30	1	1	5	50	50
US1BW	SOD-123FL	1	100	30	1	1	5	100	50
US1DW	SOD-123FL	1	200	30	1	1	5	200	50
US1GW	SOD-123FL	1	400	30	1.3	1	5	400	50
US1JW	SOD-123FL	1	600	30	1.7	1	5	600	75
US1KW	SOD-123FL	1	800	30	1.7	1	5	800	75
US1MW	SOD-123FL	1	1000	30	1.7	1	5	1000	75
US1AF	SMAF	1	50	30	1	1	5	50	50
US1BF	SMAF	1	100	30	1	1	5	100	50
US1DF	SMAF	1	200	30	1	1	5	200	50

高效整流二极管 (High Efficiency Rectifier Diode)

Type	Package outline	I _o	V _{RRM}	I _{FSM}	V _F		I _R		T _{RR}
		A	V	A	V	I _F (A)	μA	V _R (V)	ns
US1GF	SMAF	1	400	30	1.3	1	5	400	50
US1JF	SMAF	1	600	30	1.7	1	5	600	75
US1KF	SMAF	1	800	30	1.7	1	5	800	75
US1MF	SMAF	1	1000	30	1.7	1	5	1000	75
US2AF	SMAF	2	50	50	1	2	5	50	50
US2BF	SMAF	2	100	50	1	2	5	100	50
US2DF	SMAF	2	200	50	1	2	5	200	50
US2GF	SMAF	2	400	50	1.3	2	5	400	50
US2JF	SMAF	2	600	50	1.7	2	5	600	75
US2KF	SMAF	2	800	50	1.7	2	5	800	75
US2MF	SMAF	2	1000	50	1.7	2	5	1000	75
US3AF	SMAF	3	50	80	1	3	5	50	50
US3BF	SMAF	3	100	80	1	3	5	100	50
US3DF	SMAF	3	200	80	1	3	5	200	50
US3GF	SMAF	3	400	80	1.3	3	5	400	50
US3JF	SMAF	3	600	80	1.7	3	5	600	75
US3KF	SMAF	3	800	80	1.7	3	5	800	75
US3MF	SMAF	3	1000	80	1.7	3	5	1000	75
US2ABF	SMBF	2	50	50	1	2	5	50	50
US2BBF	SMBF	2	100	50	1	2	5	100	50
US2DBF	SMBF	2	200	50	1	2	5	200	50
US2GBF	SMBF	2	400	50	1.3	2	5	400	50
US2JBF	SMBF	2	600	50	1.7	2	5	600	75
US2KBF	SMBF	2	800	50	1.7	2	5	800	75
US2MBF	SMBF	2	1000	50	1.7	2	5	1000	75
US3ABF	SMBF	3	50	80	1	3	5	50	50
US3BBF	SMBF	3	100	80	1	3	5	100	50
US3DBF	SMBF	3	200	80	1	3	5	200	50
US3GBF	SMBF	3	400	80	1.3	3	5	400	50
US3JBF	SMBF	3	600	80	1.7	3	5	600	75
US3KBF	SMBF	3	800	80	1.7	3	5	800	75
US3MBF	SMBF	3	1000	80	1.7	3	5	1000	75
US5ABF	SMBF	5	50	100	1	5	5	50	50
US5BBF	SMBF	5	100	100	1	5	5	100	50
US5DBF	SMBF	5	200	100	1	5	5	200	50
US5GBF	SMBF	5	400	100	1.3	5	5	400	50
US5JBF	SMBF	5	600	100	1.7	5	5	600	75
US5KBF	SMBF	5	800	100	1.7	5	5	800	75
US5MBF	SMBF	5	1000	100	1.7	5	5	1000	75
US1A	SMA	1	50	30	1	1	5	50	50
US1B	SMA	1	100	30	1	1	5	100	50
US1D	SMA	1	200	30	1	1	5	200	50
US1G	SMA	1	400	30	1.3	1	5	400	50
US1J	SMA	1	600	30	1.7	1	5	600	75
US1K	SMA	1	800	30	1.7	1	5	800	75
US1M	SMA	1	1000	30	1.7	1	5	1000	75
US2A	SMA	2	50	50	1	2	5	50	50
US2B	SMA	2	100	50	1	2	5	100	50

快恢复二极管 (Fast Recovery Rectifier Diode)

Type	Package outline	I_o	V_{RRM}	I_{FSM}	V_F		I_R		T_{RR}
		A	V	A	V	$I_F(A)$	μA	$V_R(V)$	ns
RS2D	SMA	2	200	50	1.3	2	5	200	150
RS2G	SMA	2	400	50	1.3	2	5	400	150
RS2J	SMA	2	600	50	1.3	2	5	600	250
RS2K	SMA	2	800	50	1.3	2	5	800	500
RS2M	SMA	2	1000	50	1.3	2	5	1000	500
RS2AB	SMB	2	50	50	1.3	2	5	50	150
RS2BB	SMB	2	100	50	1.3	2	5	100	150
RS2DB	SMB	2	200	50	1.3	2	5	200	150
RS2GB	SMB	2	400	50	1.3	2	5	400	150
RS2JB	SMB	2	600	50	1.3	2	5	600	250
RS2KB	SMB	2	800	50	1.3	2	5	800	500
RS2MB	SMB	2	1000	50	1.3	2	5	1000	500
RS3AB	SMB	3	50	80	1.3	3	5	50	150
RS3BB	SMB	3	100	80	1.3	3	5	100	150
RS3DB	SMB	3	200	80	1.3	3	5	200	150
RS3GB	SMB	3	400	80	1.3	3	5	400	150
RS3JB	SMB	3	600	80	1.3	3	5	600	250
RS3KB	SMB	3	800	80	1.3	3	5	800	500
RS3MB	SMB	3	1000	80	1.3	3	5	1000	500
RS3AC	SMC	3	50	80	1.3	3	5	50	150
RS3BC	SMC	3	100	80	1.3	3	5	100	150
RS3DC	SMC	3	200	80	1.3	3	5	200	150
RS3GC	SMC	3	400	80	1.3	3	5	400	150
RS3JC	SMC	3	600	80	1.3	3	5	600	250
RS3KC	SMC	3	800	80	1.3	3	5	800	500
RS3MC	SMC	3	1000	80	1.3	3	5	1000	500
RS5AC	SMC	5	50	100	1.3	5	5	50	150
RS5BC	SMC	5	100	100	1.3	5	5	100	150
RS5DC	SMC	5	200	100	1.3	5	5	200	150
RS5GC	SMC	5	400	100	1.3	5	5	400	150
RS5JC	SMC	5	600	100	1.3	5	5	600	250
RS5KC	SMC	5	800	100	1.3	5	5	800	500
RS5MC	SMC	5	1000	100	1.3	5	5	1000	500

高效整流二极管 (High Efficiency Rectifier Diode)



Type	Package outline	I_o	V_{RRM}	I_{FSM}	V_F		I_R		T_{RR}
		A	V	A	V	$I_F(A)$	μA	$V_R(V)$	ns
US1AW	SOD-123FL	1	50	30	1	1	5	50	50
US1BW	SOD-123FL	1	100	30	1	1	5	100	50
US1DW	SOD-123FL	1	200	30	1	1	5	200	50
US1GW	SOD-123FL	1	400	30	1.3	1	5	400	50
US1JW	SOD-123FL	1	600	30	1.7	1	5	600	75
US1KW	SOD-123FL	1	800	30	1.7	1	5	800	75
US1MW	SOD-123FL	1	1000	30	1.7	1	5	1000	75
US1AF	SMAF	1	50	30	1	1	5	50	50
US1BF	SMAF	1	100	30	1	1	5	100	50
US1DF	SMAF	1	200	30	1	1	5	200	50

高效整流二极管 (High Efficiency Rectifier Diode)

Type	Package outline	I_o	V_{RRM}	I_{FSM}	V_F		I_R		T_{RR}
		A	V	A	V	$I_F(A)$	μA	$V_R(V)$	ns
US1GF	SMAF	1	400	30	1.3	1	5	400	50
US1JF	SMAF	1	600	30	1.7	1	5	600	75
US1KF	SMAF	1	800	30	1.7	1	5	800	75
US1MF	SMAF	1	1000	30	1.7	1	5	1000	75
US2AF	SMAF	2	50	50	1	2	5	50	50
US2BF	SMAF	2	100	50	1	2	5	100	50
US2DF	SMAF	2	200	50	1	2	5	200	50
US2GF	SMAF	2	400	50	1.3	2	5	400	50
US2JF	SMAF	2	600	50	1.7	2	5	600	75
US2KF	SMAF	2	800	50	1.7	2	5	800	75
US2MF	SMAF	2	1000	50	1.7	2	5	1000	75
US3AF	SMAF	3	50	80	1	3	5	50	50
US3BF	SMAF	3	100	80	1	3	5	100	50
US3DF	SMAF	3	200	80	1	3	5	200	50
US3GF	SMAF	3	400	80	1.3	3	5	400	50
US3JF	SMAF	3	600	80	1.7	3	5	600	75
US3KF	SMAF	3	800	80	1.7	3	5	800	75
US3MF	SMAF	3	1000	80	1.7	3	5	1000	75
US2ABF	SMBF	2	50	50	1	2	5	50	50
US2BBF	SMBF	2	100	50	1	2	5	100	50
US2DBF	SMBF	2	200	50	1	2	5	200	50
US2GBF	SMBF	2	400	50	1.3	2	5	400	50
US2JBF	SMBF	2	600	50	1.7	2	5	600	75
US2KBF	SMBF	2	800	50	1.7	2	5	800	75
US2MBF	SMBF	2	1000	50	1.7	2	5	1000	75
US3ABF	SMBF	3	50	80	1	3	5	50	50
US3BBF	SMBF	3	100	80	1	3	5	100	50
US3DBF	SMBF	3	200	80	1	3	5	200	50
US3GBF	SMBF	3	400	80	1.3	3	5	400	50
US3JBF	SMBF	3	600	80	1.7	3	5	600	75
US3KBF	SMBF	3	800	80	1.7	3	5	800	75
US3MBF	SMBF	3	1000	80	1.7	3	5	1000	75
US5ABF	SMBF	5	50	100	1	5	5	50	50
US5BBF	SMBF	5	100	100	1	5	5	100	50
US5DBF	SMBF	5	200	100	1	5	5	200	50
US5GBF	SMBF	5	400	100	1.3	5	5	400	50
US5JBF	SMBF	5	600	100	1.7	5	5	600	75
US5KBF	SMBF	5	800	100	1.7	5	5	800	75
US5MBF	SMBF	5	1000	100	1.7	5	5	1000	75
US1A	SMA	1	50	30	1	1	5	50	50
US1B	SMA	1	100	30	1	1	5	100	50
US1D	SMA	1	200	30	1	1	5	200	50
US1G	SMA	1	400	30	1.3	1	5	400	50
US1J	SMA	1	600	30	1.7	1	5	600	75
US1K	SMA	1	800	30	1.7	1	5	800	75
US1M	SMA	1	1000	30	1.7	1	5	1000	75
US2A	SMA	2	50	50	1	2	5	50	50
US2B	SMA	2	100	50	1	2	5	100	50

高效整流二极管 (High Efficiency Rectifier Diode)

Type	Package outline	I _o	V _{RRM}	I _{FSM}	V _F		I _R		T _{RR}
		A	V	A	V	I _F (A)	μA	V _R (V)	ns
US2D	SMA	2	200	50	1	2	5	200	50
US2G	SMA	2	400	50	1.3	2	5	400	50
US2J	SMA	2	600	50	1.7	2	5	600	75
US2K	SMA	2	800	50	1.7	2	5	800	75
US2M	SMA	2	1000	50	1.7	2	5	1000	75
US2AB	SMB	2	50	50	1	2	5	50	50
US2BB	SMB	2	100	50	1	2	5	100	50
US2DB	SMB	2	200	50	1	2	5	200	50
US2GB	SMB	2	400	50	1.3	2	5	400	50
US2JB	SMB	2	600	50	1.7	2	5	600	75
US2KB	SMB	2	800	50	1.7	2	5	800	75
US2MB	SMB	2	1000	50	1.7	2	5	1000	75
US3AB	SMB	3	50	80	1	3	5	50	50
US3BB	SMB	3	100	80	1	3	5	100	50
US3DB	SMB	3	200	80	1	3	5	200	50
US3GB	SMB	3	400	80	1.3	3	5	400	50
US3JB	SMB	3	600	80	1.7	3	5	600	75
US3KB	SMB	3	800	80	1.7	3	5	800	75
US3MB	SMB	3	1000	80	1.7	3	5	1000	75
US3AC	SMC	3	50	80	1	3	5	50	50
US3BC	SMC	3	100	80	1	3	5	100	50
US3DC	SMC	3	200	80	1	3	5	200	50
US3GC	SMC	3	400	80	1.3	3	5	400	50
US3JC	SMC	3	600	80	1.7	3	5	600	75
US3KC	SMC	3	800	80	1.7	3	5	800	75
US3MC	SMC	3	1000	80	1.7	3	5	1000	75
US5AC	SMC	5	50	100	1	5	5	50	50
US5BC	SMC	5	100	100	1	5	5	100	50
US5DC	SMC	5	200	100	1	5	5	200	50
US5GC	SMC	5	400	100	1.3	5	5	400	50
US5JC	SMC	5	600	100	1.7	5	5	600	75
US5KC	SMC	5	800	100	1.7	5	5	800	75
US5MC	SMC	5	1000	100	1.7	5	5	1000	75

超快恢复二极管 (Super Fast Recovery Rectifier Diode)



Type	Package outline	I _o	V _{RRM}	I _{FSM}	V _F		I _R		T _{RR}
		A	V	A	V	I _F (A)	μA	V _R (V)	ns
ES1AW	SOD-123FL	1	50	30	1	1	5	50	35
ES1BW	SOD-123FL	1	100	30	1	1	5	100	35
ES1DW	SOD-123FL	1	200	30	1	1	5	200	35
ES1GW	SOD-123FL	1	400	30	1.25	1	5	400	35
ES1JW	SOD-123FL	1	600	30	1.7	1	5	600	35
ES1AF	SMAF	1	50	30	1	1	5	50	35

超快恢复二极管 (Super Fast Recovery Rectifier Diode)

Type	Package outline	I _o	V _{RRM}	I _{FSM}	V _F		I _R		T _{RR}
		A	V	A	V	I _F (A)	μA	V _R (V)	ns
ES1BF	SMAF	1	100	30	1	1	5	100	35
ES1DF	SMAF	1	200	30	1	1	5	200	35
ES1GF	SMAF	1	400	30	1.25	1	5	400	35
ES1JF	SMAF	1	600	30	1.7	1	5	600	35
ES2AF	SMAF	2	50	50	1	2	5	50	35
ES2BF	SMAF	2	100	50	1	2	5	100	35
ES2DF	SMAF	2	200	50	1	2	5	200	35
ES2GF	SMAF	2	400	50	1.25	2	5	400	35
ES2JF	SMAF	2	600	50	1.7	2	5	600	35
ES3AF	SMAF	3	50	80	1	3	5	50	35
ES3BF	SMAF	3	100	80	1	3	5	100	35
ES3DF	SMAF	3	200	80	1	3	5	200	35
ES3GF	SMAF	3	400	80	1.25	3	5	400	35
ES3JF	SMAF	3	600	80	1.7	3	5	600	35
ES2ABF	SMBF	2	50	50	1	2	5	50	35
ES2BBF	SMBF	2	100	50	1	2	5	100	35
ES2DBF	SMBF	2	200	50	1	2	5	200	35
ES2GBF	SMBF	2	400	50	1.25	2	5	400	35
ES2JBF	SMBF	2	600	50	1.7	2	5	600	35
ES3ABF	SMBF	3	50	80	1	3	5	50	35
ES3BBF	SMBF	3	100	80	1	3	5	100	35
ES3DBF	SMBF	3	200	80	1	3	5	200	35
ES3GBF	SMBF	3	400	80	1.25	3	5	400	35
ES3JBF	SMBF	3	600	80	1.7	3	5	600	35
ES1A	SMA	1	50	30	1	1	5	50	35
ES1B	SMA	1	100	30	1	1	5	100	35
ES1D	SMA	1	200	30	1	1	5	200	35
ES1G	SMA	1	400	30	1.25	1	5	400	35
ES1J	SMA	1	600	30	1.7	1	5	600	35
ES2A	SMA	2	50	50	1	2	5	50	35
ES2B	SMA	2	100	50	1	2	5	100	35
ES2D	SMA	2	200	50	1	2	5	200	35
ES2G	SMA	2	400	50	1.25	2	5	400	35
ES2J	SMA	2	600	50	1.7	2	5	600	35
ES2AB	SMB	2	50	50	1	2	5	50	35
ES2BB	SMB	2	100	50	1	2	5	100	35
ES2DB	SMB	2	200	50	1	2	5	200	35
ES2GB	SMB	2	400	50	1.25	2	5	400	35
ES2JB	SMB	2	600	50	1.7	2	5	600	35
ES3AB	SMB	3	50	80	1	3	5	50	35
ES3BB	SMB	3	100	80	1	3	5	100	35
ES3DB	SMB	3	200	80	1	3	5	200	35
ES3GB	SMB	3	400	80	1.25	3	5	400	35
ES3JB	SMB	3	600	80	1.7	3	5	600	35
ES3AC	SMC	3	50	100	1	3	5	50	35
ES3BC	SMC	3	100	100	1	3	5	100	35
ES3DC	SMC	3	200	100	1	3	5	200	35
ES3GC	SMC	3	400	100	1.25	3	5	400	35
ES3JC	SMC	3	600	100	1.7	3	5	600	35
ES5AC	SMC	5	50	100	1	5	5	50	35
ES5BC	SMC	5	100	100	1	5	5	100	35
ES5DC	SMC	5	200	100	1	5	5	200	35
ES5GC	SMC	5	400	100	1.25	5	5	400	35
ES5JC	SMC	5	600	100	1.7	5	5	600	35

高效整流二极管 (High Efficiency Rectifier Diode)

Type	Package outline	I _o	V _{RRM}	I _{FSM}	V _F		I _R		T _{RR}
		A	V	A	V	I _F (A)	μA	V _R (V)	ns
US2D	SMA	2	200	50	1	2	5	200	50
US2G	SMA	2	400	50	1.3	2	5	400	50
US2J	SMA	2	600	50	1.7	2	5	600	75
US2K	SMA	2	800	50	1.7	2	5	800	75
US2M	SMA	2	1000	50	1.7	2	5	1000	75
US2AB	SMB	2	50	50	1	2	5	50	50
US2BB	SMB	2	100	50	1	2	5	100	50
US2DB	SMB	2	200	50	1	2	5	200	50
US2GB	SMB	2	400	50	1.3	2	5	400	50
US2JB	SMB	2	600	50	1.7	2	5	600	75
US2KB	SMB	2	800	50	1.7	2	5	800	75
US2MB	SMB	2	1000	50	1.7	2	5	1000	75
US3AB	SMB	3	50	80	1	3	5	50	50
US3BB	SMB	3	100	80	1	3	5	100	50
US3DB	SMB	3	200	80	1	3	5	200	50
US3GB	SMB	3	400	80	1.3	3	5	400	50
US3JB	SMB	3	600	80	1.7	3	5	600	75
US3KB	SMB	3	800	80	1.7	3	5	800	75
US3MB	SMB	3	1000	80	1.7	3	5	1000	75
US3AC	SMC	3	50	80	1	3	5	50	50
US3BC	SMC	3	100	80	1	3	5	100	50
US3DC	SMC	3	200	80	1	3	5	200	50
US3GC	SMC	3	400	80	1.3	3	5	400	50
US3JC	SMC	3	600	80	1.7	3	5	600	75
US3KC	SMC	3	800	80	1.7	3	5	800	75
US3MC	SMC	3	1000	80	1.7	3	5	1000	75
US5AC	SMC	5	50	100	1	5	5	50	50
US5BC	SMC	5	100	100	1	5	5	100	50
US5DC	SMC	5	200	100	1	5	5	200	50
US5GC	SMC	5	400	100	1.3	5	5	400	50
US5JC	SMC	5	600	100	1.7	5	5	600	75
US5KC	SMC	5	800	100	1.7	5	5	800	75
US5MC	SMC	5	1000	100	1.7	5	5	1000	75

超快恢复二极管 (Super Fast Recovery Rectifier Diode)



Type	Package outline	I _o	V _{RRM}	I _{FSM}	V _F		I _R		T _{RR}
		A	V	A	V	I _F (A)	μA	V _R (V)	ns
ES1AW	SOD-123FL	1	50	30	1	1	5	50	35
ES1BW	SOD-123FL	1	100	30	1	1	5	100	35
ES1DW	SOD-123FL	1	200	30	1	1	5	200	35
ES1GW	SOD-123FL	1	400	30	1.25	1	5	400	35
ES1JW	SOD-123FL	1	600	30	1.7	1	5	600	35
ES1AF	SMAF	1	50	30	1	1	5	50	35

超快恢复二极管 (Super Fast Recovery Rectifier Diode)

Type	Package outline	I _o	V _{RRM}	I _{FSM}	V _F		I _R		T _{RR}
		A	V	A	V	I _F (A)	μA	V _R (V)	ns
ES1BF	SMAF	1	100	30	1	1	5	100	35
ES1DF	SMAF	1	200	30	1	1	5	200	35
ES1GF	SMAF	1	400	30	1.25	1	5	400	35
ES1JF	SMAF	1	600	30	1.7	1	5	600	35
ES2AF	SMAF	2	50	50	1	2	5	50	35
ES2BF	SMAF	2	100	50	1	2	5	100	35
ES2DF	SMAF	2	200	50	1	2	5	200	35
ES2GF	SMAF	2	400	50	1.25	2	5	400	35
ES2JF	SMAF	2	600	50	1.7	2	5	600	35
ES3AF	SMAF	3	50	80	1	3	5	50	35
ES3BF	SMAF	3	100	80	1	3	5	100	35
ES3DF	SMAF	3	200	80	1	3	5	200	35
ES3GF	SMAF	3	400	80	1.25	3	5	400	35
ES3JF	SMAF	3	600	80	1.7	3	5	600	35
ES2ABF	SMBF	2	50	50	1	2	5	50	35
ES2BBF	SMBF	2	100	50	1	2	5	100	35
ES2DBF	SMBF	2	200	50	1	2	5	200	35
ES2GBF	SMBF	2	400	50	1.25	2	5	400	35
ES2JBF	SMBF	2	600	50	1.7	2	5	600	35
ES3ABF	SMBF	3	50	80	1	3	5	50	35
ES3BBF	SMBF	3	100	80	1	3	5	100	35
ES3DBF	SMBF	3	200	80	1	3	5	200	35
ES3GBF	SMBF	3	400	80	1.25	3	5	400	35
ES3JBF	SMBF	3	600	80	1.7	3	5	600	35
ES1A	SMA	1	50	30	1	1	5	50	35
ES1B	SMA	1	100	30	1	1	5	100	35
ES1D	SMA	1	200	30	1	1	5	200	35
ES1G	SMA	1	400	30	1.25	1	5	400	35
ES1J	SMA	1	600	30	1.7	1	5	600	35
ES2A	SMA	2	50	50	1	2	5	50	35
ES2B	SMA	2	100	50	1	2	5	100	35
ES2D	SMA	2	200	50	1	2	5	200	35
ES2G	SMA	2	400	50	1.25	2	5	400	35
ES2J	SMA	2	600	50	1.7	2	5	600	35
ES2AB	SMB	2	50	50	1	2	5	50	35
ES2BB	SMB	2	100	50	1	2	5	100	35
ES2DB	SMB	2	200	50	1	2	5	200	35
ES2GB	SMB	2	400	50	1.25	2	5	400	35
ES2JB	SMB	2	600	50	1.7	2	5	600	35
ES3AB	SMB	3	50	80	1	3	5	50	35
ES3BB	SMB	3	100	80	1	3	5	100	35
ES3DB	SMB	3	200	80	1	3	5	200	35
ES3GB	SMB	3	400	80	1.25	3	5	400	35
ES3JB	SMB	3	600	80	1.7	3	5	600	35
ES3AC	SMC	3	50	100	1	3	5	50	35
ES3BC	SMC	3	100	100	1	3	5	100	35
ES3DC	SMC	3	200	100	1	3	5	200	35
ES3GC	SMC	3	400	100	1.25	3	5	400	35
ES3JC	SMC	3	600	100	1.7	3	5	600	35
ES5AC	SMC	5	50	100	1	5	5	50	35
ES5BC	SMC	5	100	100	1	5	5	100	35
ES5DC	SMC	5	200	100	1	5	5	200	35
ES5GC	SMC	5	400	100	1.25	5	5	400	35
ES5JC	SMC	5	600	100	1.7	5	5	600	35

超快恢复二极管 (Super Fast Recovery Rectifier Diode)

Voltage	Part Name	I _F (A)	V _R (V)	V _F (V) I _F =额定电流		I _R (μ A) V _R =额定电压		trr(ns)		I _{FSM} (A)	封装
		Spec	Min.	Max.	Typ.	Max.	Typ.	Max.	Typ.	Spec	
200	HLR12U02	6×2	200	1.10	0.90	1.00	0.03	30	25	72	TO-220F, TO-220
	HLR16U02	8×2	200	1.10	0.98	1.00	0.03	30	25	80	TO-220F, TO-220
	HLR20U02	10×2	200	1.10	0.98	1.00	0.03	30	25	96	TO-220F, TO-220, TO-3P, TO-247
	HLR40U02	20×2	200	1.10	0.92	1.00	0.03	35	28	240	TO-3P, TO-247
	HLR60U02	30×2	200	1.10	0.96	1.00	0.03	35	28	360	TO-3P, TO-247
	HLR70U02	35×2	200	1.10	0.95	1.00	0.03	35	28	380	TO-3P, TO-247
	HLR80U02	40×2	200	1.10	0.95	1.00	0.03	35	28	480	TO-3P, TO-247
	HLR06U02	6	200	1.10	0.90	1.00	0.03	30	25	72	TO-220F-2, TO-220-2
	HLR08U02	8	200	1.10	0.98	1.00	0.03	30	25	80	TO-220F-2, TO-220-2
	HLR12U02	12	200	1.10	0.98	1.00	0.03	30	25	96	TO-220F-2, TO-220-2
	HLR15U02	15	200	1.10	0.98	1.00	0.03	30	25	120	TO-220F-2, TO-220-2
	HLR20U02	20	200	1.10	0.98	1.00	0.03	30	25	120	TO-220F-2, TO-220-2
	HLR30U02	30	200	1.10	0.96	1.00	0.03	35	28	360	TO-247-2
	HLR40U02	40	200	1.10	0.95	1.00	0.03	35	28	480	TO-247-2
	HLR60U02	60	200	1.10	0.94	1.00	0.03	35	28	720	TO-247-2
300	HLR30U03	15×2	300	1.15	0.96	2.00	0.05	35	28	180	TO-3P, TO-247
	HLR40U03	20×2	300	1.15	0.96	2.00	0.05	35	28	220	TO-3P, TO-247
	HLR50U03	25×2	300	1.15	0.96	2.00	0.05	40	30	280	TO-3P, TO-247
	HLR60U03	30×2	300	1.15	0.97	2.00	0.05	40	30	300	TO-3P, TO-247
	HLR80U03	40×2	300	1.20	1.02	3.00	0.05	40	30	420	TO-3P, TO-247
	HLR15U03	15	300	1.15	0.96	2.00	0.05	35	28	180	TO-220F-2, TO-220-2
	HLR20U03	20	300	1.15	0.96	2.00	0.05	35	28	220	TO-220F-2, TO-220-2
	HLR25U03	25	300	1.15	0.96	2.00	0.05	40	30	280	TO-220F-2, TO-220-2
	HLR30U03	30	300	1.15	0.97	2.00	0.05	40	30	300	TO-247-2
400	HLR40U03	40	300	1.20	1.02	3.00	0.05	40	30	420	TO-247-2
	HLR12U04	6×2	400	1.35	1.15	2.00	0.03	35	25	60	TO-220F, TO-220
	HLR16U04	8×2	400	1.35	1.15	2.00	0.03	35	25	72	TO-220F, TO-220
	HLR20U04	10×2	400	1.35	1.20	2.00	0.03	35	26	150	TO-220F, TO-220
	HLR30U04	15×2	400	1.35	1.20	2.00	0.03	35	26	180	TO-220F, TO-220
	HLR60F40	60	400	1.35	1.20	3.00	0.05	40	30	640	TO-3P, TO-247
	HLR80U40	40×2	400	1.35	1.20	3.00	0.05	40	30	640	TO-3P, TO-247
	HLR6U04	6	400	1.35	1.15	2.00	0.03	35	25	60	TO-220F-2, TO-220-2
	HLR8U04	8	400	1.35	1.15	2.00	0.03	35	25	72	TO-220F-2, TO-220-2
	HLR10U04	10	400	1.35	1.20	2.00	0.03	35	26	80	TO-220F-2, TO-220-2
	HLR15U04	15	400	1.35	1.20	2.00	0.03	35	26	120	TO-220F-2, TO-220-2
	HLR20U04	20	400	1.35	1.20	2.00	0.03	35	26	160	TO-220F-2, TO-220-2
	HLR30U04	30	400	1.35	1.20	3.00	0.03	40	30	300	TO-220F-2, TO-220-2
HLR40U40	40	400	1.35	1.20	3.00	0.05	40	30	320	TO-247-2	
HLR60U40	60	400	1.35	1.20	3.00	0.05	45	35	450	TO-247-2	
HLR60F40	60	400	1.25	1.05	3.00	0.05	65	50	640	TO-3P, TO-247	
HLR60F40	60	400	1.25	1.05	3.00	0.05	65	50	500	TO-247-2	

超快恢复二极管 (Super Fast Recovery Rectifier Diode)

Voltage	Part Name	I _F (A)	V _R (V)	V _F (V) I _F =额定电流		I _R (μ A) V _R =额定电压		trr(ns)		I _{FSM} (A)	封装
		Spec	Min.	Max.	Typ.	Max.	Typ.	Max.	Typ.	Spec	
600	HLR10U06	5×2	600	1.60	1.30	2.00	0.03	35	24	60	TO-220F, TO-220
	HLR12U06	6×2	600	1.60	1.30	2.00	0.03	35	25	80	TO-220F, TO-220
	HLR16U06	8×2	600	1.60	1.30	2.00	0.03	35	25	100	TO-220F, TO-220
	HLR20U06	10×2	600	1.60	1.30	2.00	0.03	35	26	120	TO-220F, TO-220
	HLR30U06	15×2	600	1.60	1.30	2.00	0.03	35	29	270	TO-3P, TO-247
	HLR60U06	30×2	600	1.60	1.30	3.00	0.05	55	40	520	TO-3P, TO-247
	HLR80U06	40×2	600	1.60	1.30	3.00	0.05	70	50	700	TO-3P, TO-247
	HLR5U06	5	600	1.60	1.30	2.00	0.03	35	24	50	TO-220F-2, TO-220-2
	HLR6U06	6	600	1.60	1.30	2.00	0.03	35	25	60	TO-220F-2, TO-220-2
	HLR8U06	8	600	1.60	1.30	2.00	0.03	35	25	80	TO-220F-2, TO-220-2
	HLR10U06	10	600	1.60	1.30	2.00	0.03	35	26	100	TO-220F-2, TO-220-2
	HLR12U06	12	600	1.60	1.30	2.00	0.03	40	28	120	TO-220F-2, TO-220-2
	HLR15U06	15	600	1.60	1.30	2.00	0.03	35	29	150	TO-220F-2, TO-220-2
	HLR20U06	20	600	1.60	1.30	2.00	0.03	55	38	180	TO-220F-2, TO-220-2
	HLR30U06	30	600	1.60	1.30	3.00	0.05	55	40	240	TO-220F-2, TO-220-2
	HLR40U06	40	600	1.60	1.30	3.00	0.05	70	50	320	TO-247-2
	HLR60U06	60	600	1.60	1.30	5.00	0.06	70	60	480	TO-247-2
1200	HLR60U06	60	600	1.60	1.30	5.00	0.06	70	60	600	TO-3P, TO-247
	HLR80U06	80	600	1.60	1.30	5.00	0.06	70	60	560	TO-247-2
	HLR80U06	80	600	1.60	1.30	5.00	0.06	80	65	720	TO-3P, TO-247
	HLR16U12	8×2	1200	2.60	2.00	5.00	0.20	60	40	120	TO-220F, TO-220
	HLR24U12	12×2	1200	2.60	2.00	5.00	0.30	60	40	180	TO-220F, TO-220
	HLR30U12	15×2	1200	2.60	2.00	5.00	0.50	60	45	220	TO-3P, TO-247
	HLR60U12	30×2	1200	2.60	2.00	6.00	1.00	65	55	430	TO-3P, TO-247
	HLR8U12	8	1200	2.60	2.00	5.00	0.20	60	40	64	TO-220F-2, TO-220-2
	HLR12U12	12	1200	2.60	2.00	5.00	0.30	60	45	96	TO-220F-2, TO-220-2
1200	HLR15U12	15	1200	2.60	2.00	5.00	0.50	60	45	120	TO-220F-2, TO-220-2
	HLR30U12	30	1200	2.60	2.00	6.00	1.00	65	55	180	TO-220F-2, TO-220-2, TO-247-2
	HLR60U12	60	1200	2.60	2.00	8.00	2.00	80	65	420	TO-247-2
	HLR30S12	30	1200	3.30	2.80	6.00	1.00	65	55	170	TO-220F-2, TO-220-2, TO-247-2
	HLR60S12	60	1200	3.30	2.80	8.00	2.00	80	55	380	TO-247-2
	HLR75S12	75	1200	3.50	2.90	10.00	2.00	100	80	480	TO-247-2

超快恢复二极管 (Super Fast Recovery Rectifier Diode)

超快恢复二极管 (Super Fast Recovery Rectifier Diode)

Voltage	Part Name	I _F (A) Spec	V _R (V) Min.	V _F (V) I _F =额定电流		I _R (μ A) V _R =额定电压		trr(ns)		I _{FSM} (A) Spec	封装
				Max.	Typ.	Max.	Typ.	Max.	Typ.		
200	HLR12U02	6×2	200	1.10	0.90	1.00	0.03	30	25	72	TO-220F, TO-220
	HLR16U02	8×2	200	1.10	0.98	1.00	0.03	30	25	80	TO-220F, TO-220
	HLR20U02	10×2	200	1.10	0.98	1.00	0.03	30	25	96	TO-220F, TO-220, TO-3P, TO-247
	HLR40U02	20×2	200	1.10	0.92	1.00	0.03	35	28	240	TO-3P, TO-247
	HLR60U02	30×2	200	1.10	0.96	1.00	0.03	35	28	360	TO-3P, TO-247
	HLR70U02	35×2	200	1.10	0.95	1.00	0.03	35	28	380	TO-3P, TO-247
	HLR80U02	40×2	200	1.10	0.95	1.00	0.03	35	28	480	TO-3P, TO-247
	HLR06U02	6	200	1.10	0.90	1.00	0.03	30	25	72	TO-220F-2, TO-220-2
	HLR08U02	8	200	1.10	0.98	1.00	0.03	30	25	80	TO-220F-2, TO-220-2
	HLR12U02	12	200	1.10	0.98	1.00	0.03	30	25	96	TO-220F-2, TO-220-2
	HLR15U02	15	200	1.10	0.98	1.00	0.03	30	25	120	TO-220F-2, TO-220-2
	HLR20U02	20	200	1.10	0.98	1.00	0.03	30	25	120	TO-220F-2, TO-220-2
	HLR30U02	30	200	1.10	0.96	1.00	0.03	35	28	360	TO-247-2
	HLR40U02	40	200	1.10	0.95	1.00	0.03	35	28	480	TO-247-2
HLR60U02	60	200	1.10	0.94	1.00	0.03	35	28	720	TO-247-2	
300	HLR30U03	15×2	300	1.15	0.96	2.00	0.05	35	28	180	TO-3P, TO-247
	HLR40U03	20×2	300	1.15	0.96	2.00	0.05	35	28	220	TO-3P, TO-247
	HLR50U03	25×2	300	1.15	0.96	2.00	0.05	40	30	280	TO-3P, TO-247
	HLR60U03	30×2	300	1.15	0.97	2.00	0.05	40	30	300	TO-3P, TO-247
	HLR80U03	40×2	300	1.20	1.02	3.00	0.05	40	30	420	TO-3P, TO-247
	HLR15U03	15	300	1.15	0.96	2.00	0.05	35	28	180	TO-220F-2, TO-220-2
	HLR20U03	20	300	1.15	0.96	2.00	0.05	35	28	220	TO-220F-2, TO-220-2
	HLR25U03	25	300	1.15	0.96	2.00	0.05	40	30	280	TO-220F-2, TO-220-2
	HLR30U03	30	300	1.15	0.97	2.00	0.05	40	30	300	TO-247-2
	HLR40U03	40	300	1.20	1.02	3.00	0.05	40	30	420	TO-247-2
400	HLR12U04	6×2	400	1.35	1.15	2.00	0.03	35	25	60	TO-220F, TO-220
	HLR16U04	8×2	400	1.35	1.15	2.00	0.03	35	25	72	TO-220F, TO-220
	HLR20U04	10×2	400	1.35	1.20	2.00	0.03	35	26	150	TO-220F, TO-220
	HLR30U04	15×2	400	1.35	1.20	2.00	0.03	35	26	180	TO-220F, TO-220
	HLR60F40	60	400	1.35	1.20	3.00	0.05	40	30	640	TO-3P, TO-247
	HLR80U40	40×2	400	1.35	1.20	3.00	0.05	40	30	640	TO-3P, TO-247
	HLR6U04	6	400	1.35	1.15	2.00	0.03	35	25	60	TO-220F-2, TO-220-2
	HLR8U04	8	400	1.35	1.15	2.00	0.03	35	25	72	TO-220F-2, TO-220-2
	HLR10U04	10	400	1.35	1.20	2.00	0.03	35	26	80	TO-220F-2, TO-220-2
	HLR15U04	15	400	1.35	1.20	2.00	0.03	35	26	120	TO-220F-2, TO-220-2
	HLR20U04	20	400	1.35	1.20	2.00	0.03	35	26	160	TO-220F-2, TO-220-2
	HLR30U04	30	400	1.35	1.20	3.00	0.03	40	30	300	TO-220F-2, TO-220-2
	HLR40U40	40	400	1.35	1.20	3.00	0.05	40	30	320	TO-247-2
	HLR60U40	60	400	1.35	1.20	3.00	0.05	45	35	450	TO-247-2
HLR60F40	60	400	1.25	1.05	3.00	0.05	65	50	640	TO-3P, TO-247	
HLR60F40	60	400	1.25	1.05	3.00	0.05	65	50	500	TO-247-2	

Voltage	Part Name	I _F (A) Spec	V _R (V) Min.	V _F (V) I _F =额定电流		I _R (μ A) V _R =额定电压		trr(ns)		I _{FSM} (A) Spec	封装
				Max.	Typ.	Max.	Typ.	Max.	Typ.		
600	HLR10U06	5×2	600	1.60	1.30	2.00	0.03	35	24	60	TO-220F, TO-220
	HLR12U06	6×2	600	1.60	1.30	2.00	0.03	35	25	80	TO-220F, TO-220
	HLR16U06	8×2	600	1.60	1.30	2.00	0.03	35	25	100	TO-220F, TO-220
	HLR20U06	10×2	600	1.60	1.30	2.00	0.03	35	26	120	TO-220F, TO-220
	HLR30U06	15×2	600	1.60	1.30	2.00	0.03	35	29	270	TO-3P, TO-247
	HLR60U06	30×2	600	1.60	1.30	3.00	0.05	55	40	520	TO-3P, TO-247
	HLR80U06	40×2	600	1.60	1.30	3.00	0.05	70	50	700	TO-3P, TO-247
	HLR5U06	5	600	1.60	1.30	2.00	0.03	35	24	50	TO-220F-2, TO-220-2
	HLR6U06	6	600	1.60	1.30	2.00	0.03	35	25	60	TO-220F-2, TO-220-2
	HLR8U06	8	600	1.60	1.30	2.00	0.03	35	25	80	TO-220F-2, TO-220-2
	HLR10U06	10	600	1.60	1.30	2.00	0.03	35	26	100	TO-220F-2, TO-220-2
	HLR12U06	12	600	1.60	1.30	2.00	0.03	40	28	120	TO-220F-2, TO-220-2
	HLR15U06	15	600	1.60	1.30	2.00	0.03	35	29	150	TO-220F-2, TO-220-2
	HLR20U06	20	600	1.60	1.30	2.00	0.03	55	38	180	TO-220F-2, TO-220-2
1200	HLR30U06	30	600	1.60	1.30	3.00	0.05	55	40	240	TO-220F-2, TO-220-2
	HLR40U06	40	600	1.60	1.30	3.00	0.05	70	50	320	TO-247-2
	HLR60U06	60	600	1.60	1.30	5.00	0.06	70	60	480	TO-247-2
	HLR60U06	60	600	1.60	1.30	5.00	0.06	70	60	600	TO-3P, TO-247
	HLR80U06	80	600	1.60	1.30	5.00	0.06	70	60	560	TO-247-2
	HLR80U06	80	600	1.60	1.30	5.00	0.06	80	65	720	TO-3P, TO-247
	HLR16U12	8×2	1200	2.60	2.00	5.00	0.20	60	40	120	TO-220F, TO-220
	HLR24U12	12×2	1200	2.60	2.00	5.00	0.30	60	40	180	TO-220F, TO-220
	HLR30U12	15×2	1200	2.60	2.00	5.00	0.50	60	45	220	TO-3P, TO-247
	HLR60U12	30×2	1200	2.60	2.00	6.00	1.00	65	55	430	TO-3P, TO-247
1200	HLR8U12	8	1200	2.60	2.00	5.00	0.20	60	40	64	TO-220F-2, TO-220-2
	HLR12U12	12	1200	2.60	2.00	5.00	0.30	60	45	96	TO-220F-2, TO-220-2
	HLR15U12	15	1200	2.60	2.00	5.00	0.50	60	45	120	TO-220F-2, TO-220-2
	HLR30U12	30	1200	2.60	2.00	6.00	1.00	65	55	180	TO-220F-2, TO-220-2, TO-247-2
	HLR60U12	60	1200	2.60	2.00	8.00	2.00	80	65	420	TO-247-2
	HLR30S12	30	1200	3.30	2.80	6.00	1.00	65	55	170	TO-220F-2, TO-220-2, TO-247-2
	HLR60S12	60	1200	3.30	2.80	8.00	2.00	80	55	380	TO-247-2
	HLR75S12	75	1200	3.50	2.90	10.00	2.00	100	80	480	TO-247-2

高压二极管 HD (High Voltage Rectifier Diode)

- ▲ Features:
 - Low reverse leakage
 - High forward surge current capability
 - Construction utilizes void-free molded plastic technique
 - High temperature soldering guaranteed: 260 C/10 seconds, 0.375" (9.5mm) lead length, 5 lbs. (2.3kg) tension
 - The plastic package carries Underwriters Laboratory Flammability Classification 94V-0
- ▲ Mechanical Data
 - Case: SMA
 - Terminals: Solderable per MIL-STD-750, Method 2026
 - Polarity: Color band denotes cathode end
 - Weight: 0.012 ounce, 0.33 grams

Maximum Ratings and Electrical characteristics

Ratings at 25 ambient temperature unless otherwise specified. Single phase half-wave 60 Hz, resistive or inductive load, for capacitive load current derate by 20 %.

Parameter	symbols	HD513	HD516	HD520	HD528	Units
Maximum Repetitive Peak Reverse Voltage	VRRM	1600	1800	2000	2800	V
Maximum RMS voltage	VRMS	1120	1260	1400	1960	V
Maximum DC Blocking Voltage	VDC	1600	1800	2000	2800	V
Maximum average forward rectified current 0.375" (9.5mm) lead length at TA=75 C	IF(AV)	1				A
Peak forward surge current 8.3ms single half-sine - wave superimposed on rated load (JEDEC Method)	IFSM	30				A
Maximum Instantaneous Forward Voltage at 1 A	VF	<2				V
Maximum DC Reverse Current = 25 ° C at Rated DC Blocking Voltage =125 ° C	IR	5 50				μA
Typical Junction Capacitance ¹	Cj	15				pF
Typical Thermal Resistance ²	R θ JA	50				°C/W
Operating and Storage Temperature Range	TJ,TSTG	-55~+155				°C

1. Measured at 1 MHz and applied reverse voltage of 4 V D.C Thermal resistance from junction to ambient at 0.375" (9.5mm) lead length, P.C.B. mounted

Package Outline

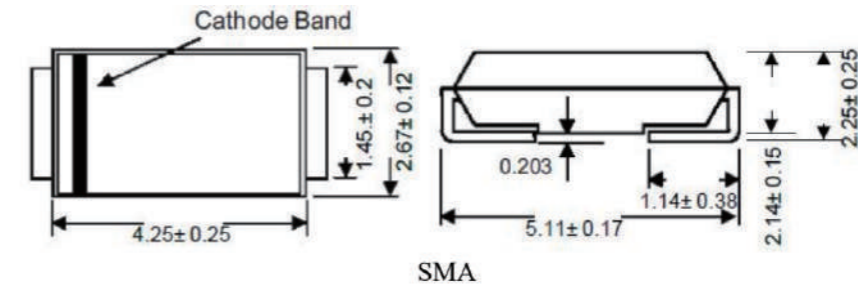

高压二极管 HD (High Voltage Rectifier Diode)

- ▲ Features:
 - Low reverse leakage
 - High forward surge current capability
 - Construction utilizes void-free molded plastic technique
 - High temperature soldering guaranteed: 260 C/10 seconds, 0.375" (9.5mm) lead length, 5 lbs. (2.3kg) tension
 - The plastic package carries Underwriters Laboratory Flammability Classification 94V-0
- ▲ Mechanical Data
 - Case: SMA
 - Terminals: Solderable per MIL-STD-750, Method 2026
 - Polarity: Color band denotes cathode end
 - Weight: 0.012 ounce, 0.33 grams

Maximum Ratings and Electrical characteristics

Ratings at 25 ambient temperature unless otherwise specified. Single phase half-wave 60 Hz, resistive or inductive load, for capacitive load current derate by 20 %.

Parameter	symbols	HD513	HD516	HD520	HD528	Units
Maximum Repetitive Peak Reverse Voltage	VRRM	1600	1800	2000	2800	V
Maximum RMS voltage	VRMS	1120	1260	1400	1960	V
Maximum DC Blocking Voltage	VDC	1600	1800	2000	2800	V
Maximum average forward rectified current 0.375" (9.5mm) lead length at TA=75 C	IF(AV)	1				A
Peak forward surge current 8.3ms single half-sine - wave superimposed on rated load (JEDEC Method)	IFSM	30				A
Maximum Instantaneous Forward Voltage at 1 A	VF	<2				V
Maximum DC Reverse Current = 25 ° C at Rated DC Blocking Voltage =125 ° C	IR	5 50				μA
Typical Junction Capacitance ¹	Cj	15				pF
Typical Thermal Resistance ²	R θ JA	50				°C/W
Operating and Storage Temperature Range	TJ,TSTG	-55~+155				°C

1. Measured at 1 MHz and applied reverse voltage of 4 V D.C Thermal resistance from junction to ambient at 0.375" (9.5mm) lead length, P.C.B. mounted

Package Outline

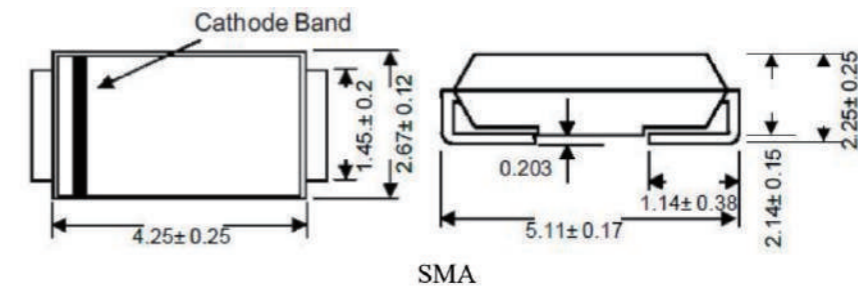

Y1ZDxxx Series (SOD-123)

- ▲ Features:
 - Total power dissipation: Max. 500mW.
 - Wide zener reverse voltage range 2.0V to 75V.
 - Small plastic package suitable for surface mounted design
 - Tolerance approximately ± 5%

PIN	DESCRIPTION
1	Cathode
2	Anode



- ▲ Mechanical Data
 - Case: SOD-123
 - Terminals: Solderable per MIL-STD-750, Method 2026

Absolute Maximum Ratings And Characteristics (Ta = 25 ° C)

Parameter	Symbol	Value	Unit
Power Dissipation	P_{tot}	500	mW
Forward Voltage at IF = 10 mA	V_F	0.9	V
Typical thermal resistance junction to ambient ⁽¹⁾	$R_{\theta JA}$	340	°C/W
Operating and Storage Temperature Range	T_j, T_{stg}	-55~+150	°C

Electrical Characteristics (TA = 25 ° C)

Type	Marking	Zener Voltage Range (1)			IZT (mA)	Dynamic Impedance		Reverse Current	
		VZT (at IZT)				ZZT (at IZT) Max (Ω)	IR Max (μA)	at VR (V)	
		Min (V)	Nom (V)	Max (V)					
Y1ZD2V0	4A	1.8	2.0	2.15	5	100	120	0.5	
Y1ZD2V2	4B	2.08	2.2	2.33	5	100	120	0.7	
Y1ZD2V4	4C	2.28	2.4	2.56	5	100	120	1	
Y1ZD2V7	4D	2.5	2.7	2.9	5	110	120	1	
Y1ZD3V0	4E	2.8	3.0	3.2	5	120	50	1	
Y1ZD3V3	4F	3.1	3.3	3.5	5	130	20	1	
Y1ZD3V6	4H	3.4	3.6	3.8	5	130	10	1	
Y1ZD3V9	4J	3.7	3.9	4.1	5	130	5	1	

Type	Marking	Zener Voltage Range (1)			IZT (mA)	Dynamic Impedance		Reverse Current	
		VZT (at IZT)				ZZT (at IZT) Max (Ω)	IR Max (μA)	at VR (V)	
		Min (V)	Nom (V)	Max (V)					
Y1ZD4V3	4K	4	4.3	1.6	5	130	5	1	
Y1ZD4V7	4M	4.4	4.7	5	5	130	2	1	
Y1ZD5V1	4N	4.8	5.1	5.4	5	130	2	1.5	
Y1ZD5V6	4P	5.2	5.6	6	5	80	1	2.5	
Y1ZD6V2	4R	5.8	6.2	6.6	5	50	1	3	
Y1ZD6V8	4X	6.4	6.8	7.2	5	30	0.5	3.5	
Y1ZD7V5	4Y	7	7.5	7.9	5	30	0.5	4	
Y1ZD8V2	4Z	7.7	8.2	8.7	5	30	0.5	5	
Y1ZD9V1	5A	8.5	9.1	9.6	5	30	0.5	6	
Y1ZD10	5B	9.4	10	10.6	5	30	0.1	7	
Y1ZD11	5C	10.4	11	11.6	5	30	0.1	8	
Y1ZD12	5D	11.4	12	12.7	5	35	0.1	9	
Y1ZD13	5E	12.4	13	14.1	5	35	0.1	10	
Y1ZD15	5F	13.8	15	15.6	5	40	0.1	11	
Y1ZD16	5H	15.3	16	17.1	5	40	0.1	12	
Y1ZD18	5J	16.8	18	19.1	5	45	0.1	13	
Y1ZD20	5K	18.8	20	21.2	5	50	0.1	15	
Y1ZD22	5M	20.8	22	23.3	5	55	0.1	17	
Y1ZD24	5N	22.8	24	25.6	5	60	0.1	19	
Y1ZD27	5P	25.1	27	28.9	5	70	0.1	21	
Y1ZD30	5R	28	30	32	5	80	0.1	23	
Y1ZD33	5X	31	33	35	5	80	0.1	25	
Y1ZD36	5Y	34	36	38	5	90	0.1	27	
Y1ZD39	5Z	37	39	41	2.5	100	2	30	
Y1ZD43	6A	40	43	46	2.5	130	2	33	
Y1ZD47	6B	44	47	50	2.5	150	2	36	
Y1ZD51	6C	48	51	54	2.5	180	1	39	
Y1ZD56	6D	52	56	60	2.5	180	1	43	
Y1ZD62	6E	58	62	66	2.5	200	0.2	47	
Y1ZD68	6F	64	68	72	2.5	250	0.2	52	
Y1ZD75	6H	70	75	79	2.5	300	0.2	57	

Y1ZDxxx Series (SOD-123)

▲ Features:

- Total power dissipation: Max. 500mW.
- Wide zener reverse voltage range 2.0V to 75V.
- Small plastic package suitable for surface mounted design
- Tolerance approximately ± 5%

▲ Mechanical Data

- Case: SOD-123
- Terminals: Solderable per MIL-STD-750, Method 2026

PIN	DESCRIPTION
1	Cathode
2	Anode



Absolute Maximum Ratings And Characteristics (Ta = 25 ° C)

Parameter	Symbol	Value	Unit
Power Dissipation	P _{tot}	500	mW
Forward Voltage at IF = 10 mA	V _F	0.9	V
Typical thermal resistance junction to ambient ⁽¹⁾	R _{θJA}	340	°C/W
Operating and Storage Temperature Range	T _J , T _{stg}	-55~+150	°C

Electrical Characteristics (TA = 25 ° C)

Type	Marking	Zener Voltage Range (1)			IZT (mA)	Dynamic Impedance	Reverse Current	
		VZT (at IZT)				ZZT (at IZT) Max (Ω)	IR Max (μA)	at VR (V)
		Min (V)	Nom (V)	Max (V)				
Y1ZD2V0	4A	1.8	2.0	2.15	5	100	120	0.5
Y1ZD2V2	4B	2.08	2.2	2.33	5	100	120	0.7
Y1ZD2V4	4C	2.28	2.4	2.56	5	100	120	1
Y1ZD2V7	4D	2.5	2.7	2.9	5	110	120	1
Y1ZD3V0	4E	2.8	3.0	3.2	5	120	50	1
Y1ZD3V3	4F	3.1	3.3	3.5	5	130	20	1
Y1ZD3V6	4H	3.4	3.6	3.8	5	130	10	1
Y1ZD3V9	4J	3.7	3.9	4.1	5	130	5	1

Type	Marking	Zener Voltage Range (1)			IZT (mA)	Dynamic Impedance	Reverse Current	
		VZT (at IZT)				ZZT (at IZT) Max (Ω)	IR Max (μA)	at VR (V)
		Min (V)	Nom (V)	Max (V)				
Y1ZD4V3	4K	4	4.3	1.6	5	130	5	1
Y1ZD4V7	4M	4.4	4.7	5	5	130	2	1
Y1ZD5V1	4N	4.8	5.1	5.4	5	130	2	1.5
Y1ZD5V6	4P	5.2	5.6	6	5	80	1	2.5
Y1ZD6V2	4R	5.8	6.2	6.6	5	50	1	3
Y1ZD6V8	4X	6.4	6.8	7.2	5	30	0.5	3.5
Y1ZD7V5	4Y	7	7.5	7.9	5	30	0.5	4
Y1ZD8V2	4Z	7.7	8.2	8.7	5	30	0.5	5
Y1ZD9V1	5A	8.5	9.1	9.6	5	30	0.5	6
Y1ZD10	5B	9.4	10	10.6	5	30	0.1	7
Y1ZD11	5C	10.4	11	11.6	5	30	0.1	8
Y1ZD12	5D	11.4	12	12.7	5	35	0.1	9
Y1ZD13	5E	12.4	13	14.1	5	35	0.1	10
Y1ZD15	5F	13.8	15	15.6	5	40	0.1	11
Y1ZD16	5H	15.3	16	17.1	5	40	0.1	12
Y1ZD18	5J	16.8	18	19.1	5	45	0.1	13
Y1ZD20	5K	18.8	20	21.2	5	50	0.1	15
Y1ZD22	5M	20.8	22	23.3	5	55	0.1	17
Y1ZD24	5N	22.8	24	25.6	5	60	0.1	19
Y1ZD27	5P	25.1	27	28.9	5	70	0.1	21
Y1ZD30	5R	28	30	32	5	80	0.1	23
Y1ZD33	5X	31	33	35	5	80	0.1	25
Y1ZD36	5Y	34	36	38	5	90	0.1	27
Y1ZD39	5Z	37	39	41	2.5	100	2	30
Y1ZD43	6A	40	43	46	2.5	130	2	33
Y1ZD47	6B	44	47	50	2.5	150	2	36
Y1ZD51	6C	48	51	54	2.5	180	1	39
Y1ZD56	6D	52	56	60	2.5	180	1	43
Y1ZD62	6E	58	62	66	2.5	200	0.2	47
Y1ZD68	6F	64	68	72	2.5	250	0.2	52
Y1ZD75	6H	70	75	79	2.5	300	0.2	57

Y1ZP35DxxxG Series (SOD-123)

▲ Features:

- Constant Voltage control
- Wide Voltage Range Selection 2.4V to 75V
- RoHS compliant / Green EMC
- Matte Tin (Sn) Lead finish
- Cathode Band

▲ Mechanical Data

- Case: SOD-123
- Terminals: Solderable per MIL-STD-750, Method 2026

Absolute Maximum Ratings And Characteristics (Ta = 25 ° C)

Parameter	Symbol	Value	Unit
Power Dissipation	P_d	350	mW
Zener current	I_{zm}	P_d/V_z	mA
Junction Temperature	T_j	150	°C
Storage Temperature Range	T_{stg}	-55~+125	°C

Electrical Characteristics (TA = 25 ° C)

Part Number	VZ*1			IZT	ZZT@IZT	ZZK@IZK	Izk	IR	VR
	Nom (V)	Min (V)	Max (V)						
Y1ZP35D2V4G	2.4	2.35	2.45	5	100	600	1	50	1
Y1ZP35D2V7G	2.7	2.65	2.75	5	100	600	1	20	1
Y1ZP35D3V0G	3	2.94	3.06	5	95	600	1	10	1
Y1ZP35D3V3G	3.3	3.23	3.37	5	95	600	1	5	1
Y1ZP35D3V6G	3.6	3.53	3.67	5	90	600	1	5	1
Y1ZP35D3V9G	3.9	3.82	3.98	5	90	600	1	3	1
Y1ZP35D4V3G	4.3	4.21	4.39	5	90	600	1	3	1
Y1ZP35D4V7G	4.7	4.61	4.79	5	80	500	1	3	2

Part Number	VZ*1			IZT	ZZT@IZT	ZZK@IZK	Izk	IR	VR
	Nom (V)	Min (V)	Max (V)						
Y1ZP35D5V1G	5.1	5	5.2	5	60	480	1	2	2
Y1ZP35D5V6G	5.6	5.49	5.71	5	40	400	1	1	2
Y1ZP35D6V2G	6.2	6.08	6.32	5	10	150	1	3	4
Y1ZP35D6V8G	6.8	6.66	6.94	5	15	80	1	2	4
Y1ZP35D7V5G	7.5	7.35	7.65	5	15	80	1	1	5
Y1ZP35D8V2G	8.2	8.04	8.36	5	15	80	1	0.7	5
Y1ZP35D9V1G	9.1	8.92	9.28	5	15	100	1	0.5	6
Y1ZP35D10G	10	9.8	10.2	5	20	150	1	0.2	7
Y1ZP35D11G	11	10.78	11.22	5	20	150	1	0.1	8
Y1ZP35D12G	12	11.76	12.24	5	25	150	1	0.1	8
Y1ZP35D13G	13	12.74	13.26	5	30	170	1	0.1	8
Y1ZP35D14G	14	13.72	14.28	5	25	110	1	0.1	10.5
Y1ZP35D15G	15	14.7	15.3	5	30	200	1	0.1	10.5
Y1ZP35D16G	16	15.68	16.32	5	40	200	1	0.1	11.2
Y1ZP35D18G	18	17.64	18.36	5	45	225	1	0.1	12.6
Y1ZP35D20G	20	19.6	20.4	5	55	225	1	0.1	14
Y1ZP35D22G	22	21.56	22.44	5	55	250	1	0.1	15.4
Y1ZP35D24G	24	23.52	24.48	5	70	10	1	0.1	16.8
Y1ZP35D27G	27	26.46	27.54	2	80	300	0.5	0.1	18.9
Y1ZP35D30G	30	29.4	30.6	2	80	300	0.5	0.1	21
Y1ZP35D33G	33	32.34	33.66	2	80	325	0.5	0.1	23.1
Y1ZP35D36G	36	35.28	36.72	2	90	350	0.5	0.1	25.2
Y1ZP35D39G	39	38.22	39.78	2	130	350	0.5	0.1	27.3
Y1ZP35D43G	43	42.14	43.86	2	130	350	0.5	0.1	29.4
Y1ZP35D47G	47	45.83	48.17	2	170	1000	0.25	0.1	36
Y1ZP35D51G	51	49.73	52.27	2	180	1300	0.25	0.1	39
Y1ZP35D56G	56	54.6	57.4	2	200	1400	0.25	0.1	43
Y1ZP35D62G	62	60.45	63.55	2	225	1400	0.25	0.1	47
Y1ZP35D68G	68	66.3	69.7	2	240	1600	0.25	0.1	52
Y1ZP35D75G	75	73.13	76.87	2	265	1700	0.25	0.1	56

Y1ZP35DxxxG Series (SOD-123)

▲ Features:

- Constant Voltage control
- Wide Voltage Range Selection 2.4V to 75V
- RoHS compliant / Green EMC
- Matte Tin (Sn) Lead finish
- Cathode Band

▲ Mechanical Data

- Case: SOD-123
- Terminals: Solderable per MIL-STD-750, Method 2026

Absolute Maximum Ratings And Characteristics (Ta = 25 ° C)

Parameter	Symbol	Value	Unit
Power Dissipation	P_d	350	mW
Zener current	I_{zm}	P_d/V_z	mA
Junction Temperature	T_j	150	°C
Storage Temperature Range	T_{stg}	-55~+125	°C

Electrical Characteristics (TA = 25 ° C)

Part Number	VZ*1			IZT	ZZT@IZT	ZZK@IZK	Izk	IR	VR
	Nom (V)	Min (V)	Max (V)						
Y1ZP35D2V4G	2.4	2.35	2.45	5	100	600	1	50	1
Y1ZP35D2V7G	2.7	2.65	2.75	5	100	600	1	20	1
Y1ZP35D3V0G	3	2.94	3.06	5	95	600	1	10	1
Y1ZP35D3V3G	3.3	3.23	3.37	5	95	600	1	5	1
Y1ZP35D3V6G	3.6	3.53	3.67	5	90	600	1	5	1
Y1ZP35D3V9G	3.9	3.82	3.98	5	90	600	1	3	1
Y1ZP35D4V3G	4.3	4.21	4.39	5	90	600	1	3	1
Y1ZP35D4V7G	4.7	4.61	4.79	5	80	500	1	3	2

Part Number	VZ*1			IZT	ZZT@IZT	ZZK@IZK	Izk	IR	VR
	Nom (V)	Min (V)	Max (V)						
Y1ZP35D5V1G	5.1	5	5.2	5	60	480	1	2	2
Y1ZP35D5V6G	5.6	5.49	5.71	5	40	400	1	1	2
Y1ZP35D6V2G	6.2	6.08	6.32	5	10	150	1	3	4
Y1ZP35D6V8G	6.8	6.66	6.94	5	15	80	1	2	4
Y1ZP35D7V5G	7.5	7.35	7.65	5	15	80	1	1	5
Y1ZP35D8V2G	8.2	8.04	8.36	5	15	80	1	0.7	5
Y1ZP35D9V1G	9.1	8.92	9.28	5	15	100	1	0.5	6
Y1ZP35D10G	10	9.8	10.2	5	20	150	1	0.2	7
Y1ZP35D11G	11	10.78	11.22	5	20	150	1	0.1	8
Y1ZP35D12G	12	11.76	12.24	5	25	150	1	0.1	8
Y1ZP35D13G	13	12.74	13.26	5	30	170	1	0.1	8
Y1ZP35D14G	14	13.72	14.28	5	25	110	1	0.1	10.5
Y1ZP35D15G	15	14.7	15.3	5	30	200	1	0.1	10.5
Y1ZP35D16G	16	15.68	16.32	5	40	200	1	0.1	11.2
Y1ZP35D18G	18	17.64	18.36	5	45	225	1	0.1	12.6
Y1ZP35D20G	20	19.6	20.4	5	55	225	1	0.1	14
Y1ZP35D22G	22	21.56	22.44	5	55	250	1	0.1	15.4
Y1ZP35D24G	24	23.52	24.48	5	70	10	1	0.1	16.8
Y1ZP35D27G	27	26.46	27.54	2	80	300	0.5	0.1	18.9
Y1ZP35D30G	30	29.4	30.6	2	80	300	0.5	0.1	21
Y1ZP35D33G	33	32.34	33.66	2	80	325	0.5	0.1	23.1
Y1ZP35D36G	36	35.28	36.72	2	90	350	0.5	0.1	25.2
Y1ZP35D39G	39	38.22	39.78	2	130	350	0.5	0.1	27.3
Y1ZP35D43G	43	42.14	43.86	2	130	350	0.5	0.1	29.4
Y1ZP35D47G	47	45.83	48.17	2	170	1000	0.25	0.1	36
Y1ZP35D51G	51	49.73	52.27	2	180	1300	0.25	0.1	39
Y1ZP35D56G	56	54.6	57.4	2	200	1400	0.25	0.1	43
Y1ZP35D62G	62	60.45	63.55	2	225	1400	0.25	0.1	47
Y1ZP35D68G	68	66.3	69.7	2	240	1600	0.25	0.1	52
Y1ZP35D75G	75	73.13	76.87	2	265	1700	0.25	0.1	56

Y3ZP2Dxxx Series (SOD323)

▲ Features:

- Constant Voltage control
- Wide Voltage Range Selection 2.4V to 75V
- SOD323-GW Thin SMD package
- RoHS compliant / Green EMC
- Matte Tin (Sn) Lead finish

▲ Mechanical Data

- Case: SOD- 323
- Terminals: Solderable per MIL-STD-750, Method 2026

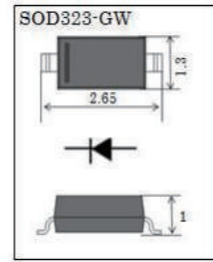

Absolute Maximum Ratings And Characteristics (Ta = 25 ° C)

Parameter	Symbol	Value	Unit
Power Dissipation	P_d	200	mW
Zener current	I_z	P_v/V_z	mA
Junction Temperature	T_j	150	°C
Storage Temperature Range	T_{stg}	-55~+150	°C

Electrical Characteristics (TA = 25 ° C)

Part Number	VZ*1			IZT	ZZT@IZT	ZZK@IZK	Izk	IR	VR
	Nom (V)	Min (V)	Max (V)						
Y3ZP2D2V4	2.4	2.35	2.45	5	100	600	1	50	1
Y3ZP2D2V7	2.7	2.65	2.75	5	100	600	1	20	1
Y3ZP2D3V0	3	2.94	3.06	5	95	600	1	10	1
Y3ZP2D3V3	3.3	3.23	3.37	5	95	600	1	5	1
Y3ZP2D3V6	3.6	3.53	3.67	5	90	600	1	5	1
Y3ZP2D3V9	3.9	3.82	3.98	5	90	600	1	3	1
Y3ZP2D4V3	4.3	4.21	4.39	5	90	600	1	3	1
Y3ZP2D4V7	4.7	4.61	4.79	5	80	500	1	3	2

Part Number	VZ*1			IZT	ZZT@IZT	ZZK@IZK	Izk	IR	VR
	Nom (V)	Min (V)	Max (V)						
Y3ZP2D5V1	5.1	5	5.2	5	60	480	1	2	2
Y3ZP2D5V6	5.6	5.49	5.71	5	40	400	1	1	2
Y3ZP2D6V2	6.2	6.08	6.32	5	10	150	1	3	4
Y3ZP2D6V8	6.8	6.66	6.94	5	15	80	1	2	4
Y3ZP2D7V5	7.5	7.35	7.65	5	15	80	1	1	5
Y3ZP2D8V2	8.2	8.04	8.36	5	15	80	1	0.7	5
Y3ZP2D9V1	9.1	8.92	9.28	5	15	100	1	0.5	6
Y3ZP2D10	10	9.8	10.2	5	20	150	1	0.2	7
Y3ZP2D11	11	10.78	11.22	5	20	150	1	0.1	8
Y3ZP2D12	12	11.76	12.24	5	25	150	1	0.1	8
Y3ZP2D13	13	12.74	13.26	5	30	170	1	0.1	8
Y3ZP2D14	14	13.72	14.28	5	25	110	1	0.1	10.5
Y3ZP2D15	15	14.7	15.3	5	30	200	1	0.1	10.5
Y3ZP2D16	16	15.68	16.32	5	40	200	1	0.1	11.2
Y3ZP2D18	18	17.64	18.36	5	45	225	1	0.1	12.6
Y3ZP2D20	20	19.6	20.4	5	55	225	1	0.1	14
Y3ZP2D22	22	21.56	22.44	5	55	250	1	0.1	15.4
Y3ZP2D24	24	23.52	24.48	5	70	10	1	0.1	16.8
Y3ZP2D27	27	26.46	27.54	2	80	300	0.5	0.1	18.9
Y3ZP2D30	30	29.4	30.6	2	80	300	0.5	0.1	21
Y3ZP2D33	33	32.34	33.66	2	80	325	0.5	0.1	23.1
Y3ZP2D36	36	35.28	36.72	2	90	350	0.5	0.1	25.2
Y3ZP2D39	39	38.22	39.78	2	130	350	0.5	0.1	27.3
Y3ZP2D43	43	42.14	43.86	2	130	350	0.5	0.1	29.4
Y3ZP2D47	47	45.83	48.17	2	170	1000	0.25	0.1	36
Y3ZP2D51	51	49.73	52.27	2	180	1300	0.25	0.1	39
Y3ZP2D56	56	54.6	57.4	2	200	1400	0.25	0.1	43
Y3ZP2D62	62	60.45	63.55	2	225	1400	0.25	0.1	47
Y3ZP2D68	68	66.3	69.7	2	240	1600	0.25	0.1	52
Y3ZP2D75	75	73.13	76.87	2	265	1700	0.25	0.1	56

Y3ZP2Dxxx Series (SOD323)

▲ Features:

- Constant Voltage control
- Wide Voltage Range Selection 2.4V to 75V
- SOD323-GW Thin SMD package
- RoHS compliant / Green EMC
- Matte Tin (Sn) Lead finish

▲ Mechanical Data

- Case: SOD- 323
- Terminals: Solderable per MIL-STD-750, Method 2026

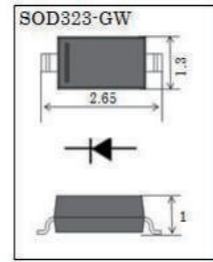

Absolute Maximum Ratings And Characteristics (Ta = 25 ° C)

Parameter	Symbol	Value	Unit
Power Dissipation	P_d	200	mW
Zener current	I_z	P_v/V_z	mA
Junction Temperature	T_j	150	°C
Storage Temperature Range	T_{stg}	-55~+150	°C

Electrical Characteristics (TA = 25 ° C)

Part Number	VZ*1			IZT	ZZT@IZT	ZZK@IZK	Izk	IR	VR
	Nom (V)	Min (V)	Max (V)						
Y3ZP2D2V4	2.4	2.35	2.45	5	100	600	1	50	1
Y3ZP2D2V7	2.7	2.65	2.75	5	100	600	1	20	1
Y3ZP2D3V0	3	2.94	3.06	5	95	600	1	10	1
Y3ZP2D3V3	3.3	3.23	3.37	5	95	600	1	5	1
Y3ZP2D3V6	3.6	3.53	3.67	5	90	600	1	5	1
Y3ZP2D3V9	3.9	3.82	3.98	5	90	600	1	3	1
Y3ZP2D4V3	4.3	4.21	4.39	5	90	600	1	3	1
Y3ZP2D4V7	4.7	4.61	4.79	5	80	500	1	3	2

Part Number	VZ*1			IZT	ZZT@IZT	ZZK@IZK	Izk	IR	VR
	Nom (V)	Min (V)	Max (V)						
Y3ZP2D5V1	5.1	5	5.2	5	60	480	1	2	2
Y3ZP2D5V6	5.6	5.49	5.71	5	40	400	1	1	2
Y3ZP2D6V2	6.2	6.08	6.32	5	10	150	1	3	4
Y3ZP2D6V8	6.8	6.66	6.94	5	15	80	1	2	4
Y3ZP2D7V5	7.5	7.35	7.65	5	15	80	1	1	5
Y3ZP2D8V2	8.2	8.04	8.36	5	15	80	1	0.7	5
Y3ZP2D9V1	9.1	8.92	9.28	5	15	100	1	0.5	6
Y3ZP2D10	10	9.8	10.2	5	20	150	1	0.2	7
Y3ZP2D11	11	10.78	11.22	5	20	150	1	0.1	8
Y3ZP2D12	12	11.76	12.24	5	25	150	1	0.1	8
Y3ZP2D13	13	12.74	13.26	5	30	170	1	0.1	8
Y3ZP2D14	14	13.72	14.28	5	25	110	1	0.1	10.5
Y3ZP2D15	15	14.7	15.3	5	30	200	1	0.1	10.5
Y3ZP2D16	16	15.68	16.32	5	40	200	1	0.1	11.2
Y3ZP2D18	18	17.64	18.36	5	45	225	1	0.1	12.6
Y3ZP2D20	20	19.6	20.4	5	55	225	1	0.1	14
Y3ZP2D22	22	21.56	22.44	5	55	250	1	0.1	15.4
Y3ZP2D24	24	23.52	24.48	5	70	10	1	0.1	16.8
Y3ZP2D27	27	26.46	27.54	2	80	300	0.5	0.1	18.9
Y3ZP2D30	30	29.4	30.6	2	80	300	0.5	0.1	21
Y3ZP2D33	33	32.34	33.66	2	80	325	0.5	0.1	23.1
Y3ZP2D36	36	35.28	36.72	2	90	350	0.5	0.1	25.2
Y3ZP2D39	39	38.22	39.78	2	130	350	0.5	0.1	27.3
Y3ZP2D43	43	42.14	43.86	2	130	350	0.5	0.1	29.4
Y3ZP2D47	47	45.83	48.17	2	170	1000	0.25	0.1	36
Y3ZP2D51	51	49.73	52.27	2	180	1300	0.25	0.1	39
Y3ZP2D56	56	54.6	57.4	2	200	1400	0.25	0.1	43
Y3ZP2D62	62	60.45	63.55	2	225	1400	0.25	0.1	47
Y3ZP2D68	68	66.3	69.7	2	240	1600	0.25	0.1	52
Y3ZP2D75	75	73.13	76.87	2	265	1700	0.25	0.1	56

Y5ZP2Dxxx Series (SOD523)

▲ Features:

- Constant Voltage control
- Wide Voltage Range Selection 2.4V to 75V
- SOD523 Thin SMD package
- RoHS compliant / Green EMC
- Matte Tin (Sn) Lead finish

▲ Mechanical Data

- Case: SOD- 523
- Terminals: Solderable per MIL-STD-750, Method 2026

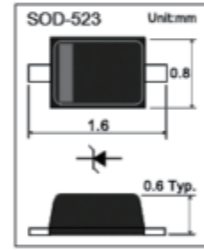

Absolute Maximum Ratings And Characteristics (Ta = 25 ° C)

Parameter	Symbol	Value	Unit
Power Dissipation	P_d	200	mW
Maximum Regulator Current	I_{zM}	P_v/V_z	mA
Junction Temperature	$T_{J,}$	150	°C
Storage Temperature Range	T_{stg}	-55~+150	°C

Electrical Characteristics (TA = 25 ° C)

Part Number	VZ*1			IZT	ZZT@IZT	ZZK@IZK	Izk	IR	VR
	Nom (V)	Min (V)	Max (V)						
Y5ZP2D2V4	2.4	2.20	2.60	5	100	600	1	50	1
Y5ZP2D2V7	2.7	2.5	2.9	5	100	600	1	20	1
Y5ZP2D3V0	3	2.8	3.2	5	95	600	1	10	1
Y5ZP2D3V3	3.3	3.1	3.5	5	95	600	1	5	1
Y5ZP2D3V6	3.6	3.4	3.8	5	90	600	1	5	1
Y5ZP2D3V9	3.9	3.7	4.1	5	90	600	1	3	1
Y5ZP2D4V3	4.3	4.0	4.6	5	90	600	1	3	1
Y5ZP2D4V7	4.7	4.4	5.0	5	80	500	1	3	2

Part Number	VZ*1			IZT	ZZT@IZT	ZZK@IZK	Izk	IR	VR
	Nom (V)	Min (V)	Max (V)						
Y5ZP2D5V1	5.1	4.8	5.4	5	60	480	1	2	2
Y5ZP2D5V6	5.6	5.2	6.0	5	40	400	1	1	2
Y5ZP2D6V2	6.2	5.8	6.6	5	10	150	1	3	4
Y5ZP2D6V8	6.8	6.4	7.2	5	15	80	1	2	4
Y5ZP2D7V5	7.5	7.0	7.9	5	15	80	1	1	5
Y5ZP2D8V2	8.2	7.7	8.7	5	15	80	1	0.7	5
Y5ZP2D9V1	9.1	8.5	9.6	5	15	100	1	0.5	6
Y5ZP2D10	10	9.4	10.6	5	20	150	1	0.2	7
Y5ZP2D11	11	10.4	11.6	5	20	150	1	0.1	8
Y5ZP2D12	12	11.4	12.7	5	25	150	1	0.1	8
Y5ZP2D13	13	12.4	14.1	5	30	170	1	0.1	8
Y5ZP2D15	15	13.8	15.6	5	30	200	1	0.1	10.5
Y5ZP2D16	16	15.3	17.1	5	40	200	1	0.1	11.2
Y5ZP2D18	18	16.8	19.1	5	45	225	1	0.1	12.6
Y5ZP2D20	20	18.8	21.2	5	55	225	1	0.1	14
Y5ZP2D22	22	20.8	23.3	5	55	250	1	0.1	15.4
Y5ZP2D24	24	22.8	25.6	5	70	10	1	0.1	16.8
Y5ZP2D27	27	25.1	28.9	2	80	300	0.5	0.1	18.9
Y5ZP2D30	30	28.0	32.0	2	80	300	0.5	0.1	21
Y5ZP2D33	33	31.0	35.0	2	80	325	0.5	0.1	23.1
Y5ZP2D36	36	34.0	38.0	2	90	350	0.5	0.1	25.2
Y5ZP2D39	39	37.0	41.0	2	130	350	0.5	0.1	27.3
Y5ZP2D43	43	40.0	46.0	2	130	350	0.5	0.1	29.4
Y5ZP2D47	47	44.65	49.35	2	170	1000	0.25	0.1	36
Y5ZP2D51	51	48.45	53.55	2	180	1300	0.25	0.1	39
Y5ZP2D56	56	53.20	58.80	2	200	1400	0.25	0.1	43
Y5ZP2D62	62	58.90	65.10	2	225	1400	0.25	0.1	47
Y5ZP2D68	68	64.60	71.40	2	240	1600	0.25	0.1	52
Y5ZP2D75	75	71.25	78.75	2	265	1700	0.25	0.1	56

Y5ZP2Dxxx Series (SOD523)

▲ Features:

- Constant Voltage control
- Wide Voltage Range Selection 2.4V to 75V
- SOD523 Thin SMD package
- RoHS compliant / Green EMC
- Matte Tin (Sn) Lead finish

▲ Mechanical Data

- Case: SOD- 523
- Terminals: Solderable per MIL-STD-750, Method 2026

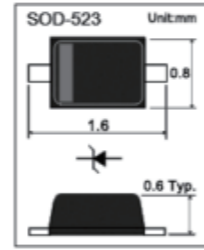

Absolute Maximum Ratings And Characteristics (Ta = 25 ° C)

Parameter	Symbol	Value	Unit
Power Dissipation	P_d	200	mW
Maximum Regulator Current	I_{zM}	P_v/V_z	mA
Junction Temperature	T_j	150	°C
Storage Temperature Range	T_{stg}	-55~+150	°C

Electrical Characteristics (TA = 25 ° C)

Part Number	VZ*1			IZT	ZZT@IZT	ZZK@IZK	Izk	IR	VR
	Nom (V)	Min (V)	Max (V)						
Y5ZP2D2V4	2.4	2.20	2.60	5	100	600	1	50	1
Y5ZP2D2V7	2.7	2.5	2.9	5	100	600	1	20	1
Y5ZP2D3V0	3	2.8	3.2	5	95	600	1	10	1
Y5ZP2D3V3	3.3	3.1	3.5	5	95	600	1	5	1
Y5ZP2D3V6	3.6	3.4	3.8	5	90	600	1	5	1
Y5ZP2D3V9	3.9	3.7	4.1	5	90	600	1	3	1
Y5ZP2D4V3	4.3	4.0	4.6	5	90	600	1	3	1
Y5ZP2D4V7	4.7	4.4	5.0	5	80	500	1	3	2

Part Number	VZ*1			IZT	ZZT@IZT	ZZK@IZK	Izk	IR	VR
	Nom (V)	Min (V)	Max (V)						
Y5ZP2D5V1	5.1	4.8	5.4	5	60	480	1	2	2
Y5ZP2D5V6	5.6	5.2	6.0	5	40	400	1	1	2
Y5ZP2D6V2	6.2	5.8	6.6	5	10	150	1	3	4
Y5ZP2D6V8	6.8	6.4	7.2	5	15	80	1	2	4
Y5ZP2D7V5	7.5	7.0	7.9	5	15	80	1	1	5
Y5ZP2D8V2	8.2	7.7	8.7	5	15	80	1	0.7	5
Y5ZP2D9V1	9.1	8.5	9.6	5	15	100	1	0.5	6
Y5ZP2D10	10	9.4	10.6	5	20	150	1	0.2	7
Y5ZP2D11	11	10.4	11.6	5	20	150	1	0.1	8
Y5ZP2D12	12	11.4	12.7	5	25	150	1	0.1	8
Y5ZP2D13	13	12.4	14.1	5	30	170	1	0.1	8
Y5ZP2D15	15	13.8	15.6	5	30	200	1	0.1	10.5
Y5ZP2D16	16	15.3	17.1	5	40	200	1	0.1	11.2
Y5ZP2D18	18	16.8	19.1	5	45	225	1	0.1	12.6
Y5ZP2D20	20	18.8	21.2	5	55	225	1	0.1	14
Y5ZP2D22	22	20.8	23.3	5	55	250	1	0.1	15.4
Y5ZP2D24	24	22.8	25.6	5	70	10	1	0.1	16.8
Y5ZP2D27	27	25.1	28.9	2	80	300	0.5	0.1	18.9
Y5ZP2D30	30	28.0	32.0	2	80	300	0.5	0.1	21
Y5ZP2D33	33	31.0	35.0	2	80	325	0.5	0.1	23.1
Y5ZP2D36	36	34.0	38.0	2	90	350	0.5	0.1	25.2
Y5ZP2D39	39	37.0	41.0	2	130	350	0.5	0.1	27.3
Y5ZP2D43	43	40.0	46.0	2	130	350	0.5	0.1	29.4
Y5ZP2D47	47	44.65	49.35	2	170	1000	0.25	0.1	36
Y5ZP2D51	51	48.45	53.55	2	180	1300	0.25	0.1	39
Y5ZP2D56	56	53.20	58.80	2	200	1400	0.25	0.1	43
Y5ZP2D62	62	58.90	65.10	2	225	1400	0.25	0.1	47
Y5ZP2D68	68	64.60	71.40	2	240	1600	0.25	0.1	52
Y5ZP2D75	75	71.25	78.75	2	265	1700	0.25	0.1	56

YAZ1Dxxx Series (SMA/DO-214AC)

▲ Features:

- Total power dissipation: Max. 1W.
- Wide zener reverse voltage range 3.3V to 330V.
- Small plastic package suitable for surface mounted design.

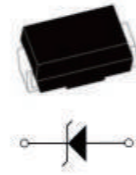

▲ Mechanical Data

- Case: SMAG
- Terminals: Solderable per MIL-STD-750, Method 2026

Absolute Maximum Ratings And Characteristics (Ta = 25 ° C)

Parameter	Symbol	Value	Unit
Power Dissipation	$P_d (T_L=75^\circ C)$	1	W
Zener current	I_z	P_v/V_z	mA
Forward voltage	$V_F(I_F=200mA)$	1.2	V
Junction Temperature Range	T_j	-55~+150	°C
Storage Temperature Range	T_{stg}	-55~+150	°C

Electrical Characteristics (TA = 25 ° C)

Part Number	Nominal Zener Voltage @IT			IZT (mA)	Maximum Zener Impedance	Maximum Reverse Leakage Current			Maximum DC Zener Current
	Nom (V)	Min (V)	Max (V)			Zzt max.@Izt (Ω)	Ir(uA)@V R	VR(V)	
YAZ1D3V3	3.3	3.10	3.50	75	10	100	1	285	
YAZ1D3V6	3.6	3.40	3.80	69	10	100	1	263	
YAZ1D3V9	3.9	3.70	4.10	64	9.0	50	1	243	
YAZ1D4V3	4.3	4.06	4.56	58	9.0	25	1	219	
YAZ1D4V7	4.7	4.50	4.93	53	8.0	10	1	203	
YAZ1D5V1	5.1	4.84	5.36	49	7.0	10	1	186	
YAZ1D5V6	5.6	5.32	5.92	45	5.0	10	2	170	
YAZ1D6V2	6.2	5.86	6.51	41	2.0	10	3	154	
YAZ1D6V8	6.8	6.46	7.18	37	3.5	10	4	140	
YAZ1D7V5	7.5	7.12	7.88	34	4.0	10	5	127	
YAZ1D8V2	8.2	7.79	8.67	31	4.5	10	6	116	
YAZ1D9V1	9.1	8.60	9.59	28	5.0	10	7	104	

Part Number	Nominal Zener Voltage @IT			IZT (mA)	Maximum Zener Impedance	Maximum Reverse Leakage Current			Maximum DC Zener Current
	Nom (V)	Min (V)	Max (V)			Zzt max.@Izt (Ω)	Ir(uA)@V R	VR(V)	
YAZ1D10	10	9.50	10.5	25	7.0	10	7	95	
YAZ1D11	11	10.4	11.6	23	8.0	5	8	86	
YAZ1D12	12	11.4	12.6	21	9.0	5	9	79	
YAZ1D13	13	12.4	14.1	19	10	5	10	71	
YAZ1D15	15	13.8	15.8	17	14	5	11	63	
YAZ1D16	16	15.2	17.1	16	16	5	12	58	
YAZ1D18	18	16.8	19.2	14	20	5	13	52	
YAZ1D20	20	19.0	21.2	13	22	5	15	47	
YAZ1D22	22	20.8	23.3	12	23	5	17	43	
YAZ1D24	24	22.8	26.0	11	25	5	18	38	
YAZ1D27	27	25.3	28.9	9.5	35	5	21	35	
YAZ1D30	30	28.2	32.0	8.5	40	5	23	31	
YAZ1D33	33	31.3	34.9	7.5	45	5	25	28	
YAZ1D36	36	34.2	37.9	7.0	50	5	27	26	
YAZ1D39	39	37.2	41.5	6.5	60	5	30	24	
YAZ1D43	43	40.9	45.6	6.0	70	1	32	22	
YAZ1D47	47	44.9	49.8	5.5	80	1	35	20	
YAZ1D51	51	48.6	54.0	5.0	95	1	38	18	
YAZ1D56	56	53.6	58.8	4.5	110	1	42	17	
YAZ1D62	62	58.9	65.6	4.0	125	1	47	15	
YAZ1D68	68	64.6	71.7	3.7	150	1	52	14	
YAZ1D75	75	71.2	78.8	3.3	175	1	56	12	
YAZ1D82	82	77.9	87.0	3.0	200	1	62	11	
YAZ1D92	91	86.0	96.0	2.8	250	1	69	10	
YAZ1D100	100	95.0	105	2.5	350	1	76	9.5	
YAZ1D110	110	104	116	2.3	450	1	84	8.6	
YAZ1D120	120	114	127	2.0	550	1	91	7.8	
YAZ1D135	135	125	142	1.9	700	1	100	7.0	
YAZ1D150	150	140	157	1.7	900	1	110	6.3	
YAZ1D165	165	155	172	1.6	1100	1	120	5.8	
YAZ1D180	180	170	191	1.4	1200	1	135	5.2	
YAZ1D200	200	189	211	1.2	1400	1	150	4.7	
YAZ1D220	220	209	231	1.0	1600	1	165	4.3	
YAZ1D240	240	229	251	1.0	1800	1	180	3.9	
YAZ1D260	260	249	271	1.0	2000	1	190	3.7	
YAZ1D280	280	269	291	1.0	2100	1	205	3.4	
YAZ1D300	300	289	315	1.0	2300	1	230	3.1	
YAZ1D330	330	313	346	1.0	2500	1	250	2.8	

ZD

YAZ1Dxxx Series (SMA/DO-214AC)

▲ Features:

- Total power dissipation: Max. 1W.
- Wide zener reverse voltage range 3.3V to 330V.
- Small plastic package suitable for surface mounted design.

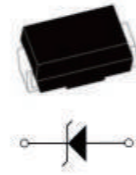

▲ Mechanical Data

- Case: SMAG
- Terminals: Solderable per MIL-STD-750, Method 2026

Absolute Maximum Ratings And Characteristics (Ta = 25 ° C)

Parameter	Symbol	Value	Unit
Power Dissipation	$P_d (T_L=75^\circ C)$	1	W
Zener current	I_z	P_v/V_z	mA
Forward voltage	$V_F(I_F=200mA)$	1.2	V
Junction Temperature Range	T_j	-55~+150	°C
Storage Temperature Range	T_{stg}	-55~+150	°C

Electrical Characteristics (TA = 25 ° C)

Part Number	Nominal Zener Voltage @IT			IZT (mA)	Maximum Zener Impedance	Maximum Reverse Leakage Current		Maximum DC Zener Current
	Nom (V)	Min (V)	Max (V)			Zzt max.@Izt (Ω)	Ir(uA)@V R	
YAZ1D3V3	3.3	3.10	3.50	75	10	100	1	285
YAZ1D3V6	3.6	3.40	3.80	69	10	100	1	263
YAZ1D3V9	3.9	3.70	4.10	64	9.0	50	1	243
YAZ1D4V3	4.3	4.06	4.56	58	9.0	25	1	219
YAZ1D4V7	4.7	4.50	4.93	53	8.0	10	1	203
YAZ1D5V1	5.1	4.84	5.36	49	7.0	10	1	186
YAZ1D5V6	5.6	5.32	5.92	45	5.0	10	2	170
YAZ1D6V2	6.2	5.86	6.51	41	2.0	10	3	154
YAZ1D6V8	6.8	6.46	7.18	37	3.5	10	4	140
YAZ1D7V5	7.5	7.12	7.88	34	4.0	10	5	127
YAZ1D8V2	8.2	7.79	8.67	31	4.5	10	6	116
YAZ1D9V1	9.1	8.60	9.59	28	5.0	10	7	104

Part Number	Nominal Zener Voltage @IT			IZT (mA)	Maximum Zener Impedance	Maximum Reverse Leakage Current		Maximum DC Zener Current
	Nom (V)	Min (V)	Max (V)			Zzt max.@Izt (Ω)	Ir(uA)@V R	
YAZ1D10	10	9.50	10.5	25	7.0	10	7	95
YAZ1D11	11	10.4	11.6	23	8.0	5	8	86
YAZ1D12	12	11.4	12.6	21	9.0	5	9	79
YAZ1D13	13	12.4	14.1	19	10	5	10	71
YAZ1D15	15	13.8	15.8	17	14	5	11	63
YAZ1D16	16	15.2	17.1	16	16	5	12	58
YAZ1D18	18	16.8	19.2	14	20	5	13	52
YAZ1D20	20	19.0	21.2	13	22	5	15	47
YAZ1D22	22	20.8	23.3	12	23	5	17	43
YAZ1D24	24	22.8	26.0	11	25	5	18	38
YAZ1D27	27	25.3	28.9	9.5	35	5	21	35
YAZ1D30	30	28.2	32.0	8.5	40	5	23	31
YAZ1D33	33	31.3	34.9	7.5	45	5	25	28
YAZ1D36	36	34.2	37.9	7.0	50	5	27	26
YAZ1D39	39	37.2	41.5	6.5	60	5	30	24
YAZ1D43	43	40.9	45.6	6.0	70	1	32	22
YAZ1D47	47	44.9	49.8	5.5	80	1	35	20
YAZ1D51	51	48.6	54.0	5.0	95	1	38	18
YAZ1D56	56	53.6	58.8	4.5	110	1	42	17
YAZ1D62	62	58.9	65.6	4.0	125	1	47	15
YAZ1D68	68	64.6	71.7	3.7	150	1	52	14
YAZ1D75	75	71.2	78.8	3.3	175	1	56	12
YAZ1D82	82	77.9	87.0	3.0	200	1	62	11
YAZ1D92	91	86.0	96.0	2.8	250	1	69	10
YAZ1D100	100	95.0	105	2.5	350	1	76	9.5
YAZ1D110	110	104	116	2.3	450	1	84	8.6
YAZ1D120	120	114	127	2.0	550	1	91	7.8
YAZ1D135	135	125	142	1.9	700	1	100	7.0
YAZ1D150	150	140	157	1.7	900	1	110	6.3
YAZ1D165	165	155	172	1.6	1100	1	120	5.8
YAZ1D180	180	170	191	1.4	1200	1	135	5.2
YAZ1D200	200	189	211	1.2	1400	1	150	4.7
YAZ1D220	220	209	231	1.0	1600	1	165	4.3
YAZ1D240	240	229	251	1.0	1800	1	180	3.9
YAZ1D260	260	249	271	1.0	2000	1	190	3.7
YAZ1D280	280	269	291	1.0	2100	1	205	3.4
YAZ1D300	300	289	315	1.0	2300	1	230	3.1
YAZ1D330	330	313	346	1.0	2500	1	250	2.8

ZD

YAZ1P5Dxxx Series (SMA/DO-214AC)

▲ Features:

- Total power dissipation: Max.1.5W.
- Wide zener reverse voltage range 3.3V to 240V.
- Small plastic package suitable for surface mounted design



▲ Mechanical Data

- Case: SMA
- Terminals: Solderable per MIL-STD-750, Method 2026
- Approx. Weight: 0.055g / 0.002oz

Absolute Maximum Ratings And Characteristics (Ta = 25 ° C)

Parameter	Symbol	Value	Unit
Power Dissipation	P _{tot}	1.5	W
Forward Voltage at IF = 10 mA	V _F	1.5	V
Operating and Storage Temperature Range	T _J , T _{stg}	-55~+150	°C

Electrical Characteristics (TA = 25 ° C)

Type	Zener Voltage Range ⁽¹⁾			I _{ZT} (mA)	Dynamic Impedance Z _t (at I _{ZT}) Max (Ω)	Reverse Current		Admissible Zener Current I _{ZM} (mA)
	V _{ZT} (at I _{ZT})					IR Max (μA)	at VR (V)	
	Min (V)	Nom (V)	Max (Ω)					
YAZ1P5D3V3	2.97	3.3	3.63	113.6	10	100	1	454
YAZ1P5D3V6	3.24	3.6	3.96	104.2	9	75	1	416
YAZ1P5D3V9	3.51	3.9	4.29	96.1	7.5	25	1	384
YAZ1P5D4V3	3.87	4.3	4.73	87.2	6	5	1	348
YAZ1P5D4V7	4.23	4.7	5.17	79.8	5	5	1.5	319
YAZ1P5D5V1	4.59	5.1	5.61	73.5	4	5	2	294
YAZ1P5D5V6	5.04	5.6	6.16	66.9	2	5	3	267
YAZ1P5D6V2	5.58	6.2	6.82	60.5	2	5	4	241

Type	Zener Voltage Range ⁽¹⁾			I _{ZT} (mA)	Dynamic Impedance Z _t (at I _{ZT}) Max (Ω)	Reverse Current		Admissible Zener Current I _{ZM} (mA)
	V _{ZT} (at I _{ZT})					IR Max (μA)	at VR (V)	
	Min (V)	Nom (V)	Max (Ω)					
YAZ1P5D6V8	6.12	6.8	7.48	55	2.5	5	5.2	220
YAZ1P5D7V5	6.75	7.5	8.25	50	3	5	6	200
YAZ1P5D8V2	7.38	8.2	9.02	45.7	3.5	5	6.5	182
YAZ1P5D9V1	8.19	9.1	10.01	41.2	4	5	7	164
YAZ1P5D10	9	10	11	37.5	4.5	5	8	150
YAZ1P5D11	9.9	11	12.1	34	5.5	1	8.4	136
YAZ1P5D12	10.8	12	13.2	31.2	6.5	1	9	125
YAZ1P5D13	11.7	13	14.3	28.8	7	1	9.9	115
YAZ1P5D15	13.5	15	16.5	25	9	1	11.4	100
YAZ1P5D16	14.4	16	17.6	23.4	10	1	12.2	93
YAZ1P5D18	16.2	18	19.8	21	12	1	13.7	83
YAZ1P5D20	18	20	22	19	14	1	15.2	75
YAZ1P5D22	19.8	22	24.2	17	18	1	16.7	68
YAZ1P5D24	21.6	24	26.4	16	19	1	18.2	62
YAZ1P5D27	24.3	27	29.7	14	23	1	20.6	55
YAZ1P5D30	27	30	33	12.5	26	1	23	50
YAZ1P5D33	29.7	33	36.3	11.4	33	1	25	45
YAZ1P5D36	32.4	36	39.6	10.4	38	1	27	41
YAZ1P5D39	35.1	39	42.9	9.6	45	1	30	38
YAZ1P5D43	38.7	43	47.3	8.7	53	1	33	34
YAZ1P5D47	42.3	47	51.7	8	67	1	36	31
YAZ1P5D51	45.9	51	56.1	7.3	70	1	39	29
YAZ1P5D56	50.4	56	61.6	6.7	86	1	42	26
YAZ1P5D62	55.8	62	68.2	6	100	1	47	24
YAZ1P5D68	61.2	68	74.8	5.5	120	1	52	22
YAZ1P5D75	67.5	75	82.5	5	140	1	57	20
YAZ1P5D82	73.8	82	90.2	4.6	160	1	62	18
YAZ1P5D91	81.9	91	100.1	4.1	200	1	69	16
YAZ1P5D100	90	100	110	3.7	250	1	76	15
YAZ1P5D110	99	110	121	3.4	300	1	84	13
YAZ1P5D120	108	120	132	3.1	380	1	91	12
YAZ1P5D130	117	130	143	2.9	450	1	100	11
YAZ1P5D150	135	150	165	2.5	600	1	114	10
YAZ1P5D160	144	160	175	2.3	700	1	121.6	9
YAZ1P5D180	162	180	198	2.1	900	1	136.8	8
YAZ1P5D200	180	200	220	1.9	1200	1	152	7
YAZ1P5D240	216	240	264	1.5	1600	1	182.4	6

YAZ1P5Dxxx Series (SMA/DO-214AC)

▲ Features:

- Total power dissipation: Max.1.5W.
- Wide zener reverse voltage range 3.3V to 240V.
- Small plastic package suitable for surface mounted design



▲ Mechanical Data

- Case: SMA
- Terminals: Solderable per MIL-STD-750, Method 2026
- Approx. Weight: 0.055g / 0.002oz

Absolute Maximum Ratings And Characteristics (Ta = 25 ° C)

Parameter	Symbol	Value	Unit
Power Dissipation	P _{tot}	1.5	W
Forward Voltage at IF = 10 mA	V _F	1.5	V
Operating and Storage Temperature Range	T _J , T _{stg}	-55~+150	°C

Electrical Characteristics (TA = 25 ° C)

Type	Zener Voltage Range ⁽¹⁾			I _{ZT} (mA)	Dynamic Impedance Z _{zt} (at I _{ZT}) Max (Ω)	Reverse Current		Admissible Zener Current I _{ZM} (mA)
	V _{ZT} (at I _{ZT})					IR Max (μA)	at VR (V)	
	Min (V)	Nom (V)	Max (Ω)					
YAZ1P5D3V3	2.97	3.3	3.63	113.6	10	100	1	454
YAZ1P5D3V6	3.24	3.6	3.96	104.2	9	75	1	416
YAZ1P5D3V9	3.51	3.9	4.29	96.1	7.5	25	1	384
YAZ1P5D4V3	3.87	4.3	4.73	87.2	6	5	1	348
YAZ1P5D4V7	4.23	4.7	5.17	79.8	5	5	1.5	319
YAZ1P5D5V1	4.59	5.1	5.61	73.5	4	5	2	294
YAZ1P5D5V6	5.04	5.6	6.16	66.9	2	5	3	267
YAZ1P5D6V2	5.58	6.2	6.82	60.5	2	5	4	241

Type	Zener Voltage Range ⁽¹⁾			I _{ZT} (mA)	Dynamic Impedance Z _{zt} (at I _{ZT}) Max (Ω)	Reverse Current		Admissible Zener Current I _{ZM} (mA)
	V _{ZT} (at I _{ZT})					IR Max (μA)	at VR (V)	
	Min (V)	Nom (V)	Max (Ω)					
YAZ1P5D6V8	6.12	6.8	7.48	55	2.5	5	5.2	220
YAZ1P5D7V5	6.75	7.5	8.25	50	3	5	6	200
YAZ1P5D8V2	7.38	8.2	9.02	45.7	3.5	5	6.5	182
YAZ1P5D9V1	8.19	9.1	10.01	41.2	4	5	7	164
YAZ1P5D10	9	10	11	37.5	4.5	5	8	150
YAZ1P5D11	9.9	11	12.1	34	5.5	1	8.4	136
YAZ1P5D12	10.8	12	13.2	31.2	6.5	1	9	125
YAZ1P5D13	11.7	13	14.3	28.8	7	1	9.9	115
YAZ1P5D15	13.5	15	16.5	25	9	1	11.4	100
YAZ1P5D16	14.4	16	17.6	23.4	10	1	12.2	93
YAZ1P5D18	16.2	18	19.8	21	12	1	13.7	83
YAZ1P5D20	18	20	22	19	14	1	15.2	75
YAZ1P5D22	19.8	22	24.2	17	18	1	16.7	68
YAZ1P5D24	21.6	24	26.4	16	19	1	18.2	62
YAZ1P5D27	24.3	27	29.7	14	23	1	20.6	55
YAZ1P5D30	27	30	33	12.5	26	1	23	50
YAZ1P5D33	29.7	33	36.3	11.4	33	1	25	45
YAZ1P5D36	32.4	36	39.6	10.4	38	1	27	41
YAZ1P5D39	35.1	39	42.9	9.6	45	1	30	38
YAZ1P5D43	38.7	43	47.3	8.7	53	1	33	34
YAZ1P5D47	42.3	47	51.7	8	67	1	36	31
YAZ1P5D51	45.9	51	56.1	7.3	70	1	39	29
YAZ1P5D56	50.4	56	61.6	6.7	86	1	42	26
YAZ1P5D62	55.8	62	68.2	6	100	1	47	24
YAZ1P5D68	61.2	68	74.8	5.5	120	1	52	22
YAZ1P5D75	67.5	75	82.5	5	140	1	57	20
YAZ1P5D82	73.8	82	90.2	4.6	160	1	62	18
YAZ1P5D91	81.9	91	100.1	4.1	200	1	69	16
YAZ1P5D100	90	100	110	3.7	250	1	76	15
YAZ1P5D110	99	110	121	3.4	300	1	84	13
YAZ1P5D120	108	120	132	3.1	380	1	91	12
YAZ1P5D130	117	130	143	2.9	450	1	100	11
YAZ1P5D150	135	150	165	2.5	600	1	114	10
YAZ1P5D160	144	160	175	2.3	700	1	121.6	9
YAZ1P5D180	162	180	198	2.1	900	1	136.8	8
YAZ1P5D200	180	200	220	1.9	1200	1	152	7
YAZ1P5D240	216	240	264	1.5	1600	1	182.4	6

YAZ2Dxxx Series (SMA/DO-214AC)

▲ Features:

Total power dissipation: Max. 2W.
Wide zener reverse voltage range 3.3V to 200V.
The marking bar indicates the cathode

▲ Mechanical Data

Case: SMAG
Terminals: Solderable per MIL-STD-750, Method 2026

Absolute Maximum Ratings And Characteristics (Ta = 25 ° C)

Parameter	Symbol	Value	Unit
Power Dissipation	$P_d (T_L=75^{\circ}C)$	2	W
Zener current	I_z	P_v/V_z	mA
Thermal resistance	$R_{\theta JA}$	75	$^{\circ}C/W$
	$R_{\theta JL}$	30	$^{\circ}C/W$
JForward voltage	$V_F(I_F=200mA)$	1.2	V
Operating and Storage Temperature Range	T_j, T_{stg}	-65~+150	$^{\circ}C$

Electrical Characteristics (TA = 25 ° C)

Part Number	Nominal Zener Voltage @IT			IZT (mA)	Maximum Zener Impedance			Maximum Reverse Leakage Current		Maximum DC Zener Current
	Nom (V)	Min (V)	Max (V)		Zzt max.@Izt (Ω)	Zzt max.@Izt (Ω)	IZK(mA)	Ir(uA)@V R	VR(V)	
YAZ2D3V3	3.3	3.14	3.47	145	8	400	1	100	1	548
YAZ2D3V6	3.6	3.42	3.78	139	5	400	1	100	1	502
YAZ2D3V9	3.9	3.71	4.1	128	5	400	1	50	1	464
YAZ2D4V3	4.3	4.09	4.52	116	4.5	400	1	50	1	421
YAZ2D4V7	4.7	4.47	4.94	106	4.5	550	1	10	1	385
YAZ2D5V1	5.1	4.85	5.36	98	3.5	600	1	10	1	354
YAZ2D5V6	5.6	5.32	5.88	89.5	2.5	500	1	10	2	323
YAZ2D6V2	6.2	5.89	6.51	80.5	1.5	700	1	10	3	292
YAZ2D6V8	6.8	6.46	7.14	73.5	2	700	1	10	4	266
YAZ2D7V5	7.5	7.13	7.88	66.5	2	700	0.5	10	5	242
YAZ2D8V2	8.2	7.79	8.61	61	2.3	700	0.5	10	6	220
YAZ2D9V1	9.1	8.65	9.56	55	2.5	700	0.5	10	7	200

Part Number	Nominal Zener Voltage @IT			IZT (mA)	Maximum Zener Impedance			Maximum Reverse Leakage Current		Maximum DC Zener Current
	Nom (V)	Min (V)	Max (V)		Zzt max.@Izt (Ω)	Zzt max.@Izt (Ω)	IZK(mA)	Ir(uA)@V R	VR(V)	
YAZ2D10	10	9.5	10.5	50	3.5	700	0.25	10	7.6	182
YAZ2D11	11	10.45	11.55	45.5	4	700	0.25	1	8.4	166
YAZ2D12	12	11.4	12.6	41.5	4.5	700	0.25	1	9.1	152
YAZ2D13	13	12.35	13.65	38.5	5	700	0.25	0.5	9.9	138
YAZ2D14	14	13.3	14.7	35.7	5.5	700	0.25	0.5	10.6	130
YAZ2D15	15	14.25	15.75	33.4	7	700	0.25	0.5	11.4	122
YAZ2D16	16	15.2	16.8	31.2	8	700	0.25	0.5	12.2	114
YAZ2D17	17	16.15	17.85	29.4	9	750	0.25	0.5	13	107
YAZ2D18	18	17.1	18.9	27.8	10	750	0.25	0.5	13.7	100
YAZ2D19	19	18.05	19.95	26.3	11	750	0.25	0.5	14.4	95
YAZ2D20	20	19	21	25	11	750	0.25	0.5	15.2	90
YAZ2D22	22	20.9	23.1	22.8	12	750	0.25	0.5	16.7	82
YAZ2D24	24	22.8	25.2	20.8	13	750	0.25	0.5	18.2	76
YAZ2D27	27	25.65	28.35	18.5	18	750	0.25	0.5	20.6	68
YAZ2D30	30	28.5	31.5	16.6	20	1000	0.25	0.5	22.5	60
YAZ2D33	33	31.35	34.65	15.1	23	1000	0.25	0.5	25.1	55
YAZ2D36	36	34.2	37.8	13.9	25	1000	0.25	0.5	27.4	50
YAZ2D39	39	37.05	40.95	12.8	30	1000	0.25	0.5	29.7	47
YAZ2D43	43	40.85	45.15	11.6	35	1500	0.25	0.5	32.7	43
YAZ2D47	47	44.65	49.35	10.6	40	1500	0.25	0.5	35.8	39
YAZ2D51	51	48.45	53.55	9.8	48	1500	0.25	0.5	38.8	36
YAZ2D56	56	53.2	58.8	9	55	2000	0.25	0.5	42.6	32
YAZ2D62	62	58.9	65.1	8.1	60	2000	0.25	0.5	47.1	29
YAZ2D68	68	64.6	71.4	7.4	75	2000	0.25	0.5	51.7	27
YAZ2D75	75	71.25	78.75	6.7	90	2000	0.25	0.5	56	24
YAZ2D82	82	77.9	86.1	6.1	100	3000	0.25	0.5	62.2	22
YAZ2D91	91	86.45	95.55	5.5	125	3000	0.25	0.5	69.2	20
YAZ2D100	100	95	105	5	175	3000	0.25	0.5	76	18
YAZ2D110	110	104.5	115.5	4.5	250	4000	0.25	0.5	83.6	17
YAZ2D120	120	114	126	4.2	325	4500	0.25	0.5	91.2	15
YAZ2D130	130	123.5	136.5	3.8	400	5000	0.25	0.5	98.8	14
YAZ2D140	140	133	147	3.6	500	5500	0.25	0.5	106.4	13
YAZ2D150	150	142.5	157.5	3.3	575	6000	0.25	0.5	114	12
YAZ2D160	160	152	168	3.1	650	6500	0.25	0.5	121.6	11
YAZ2D170	170	161.5	178.5	2.9	675	7000	0.25	0.5	130.4	11
YAZ2D180	180	171	189	2.8	725	7000	0.25	0.5	136.8	10
YAZ2D190	190	180.5	199.5	2.6	825	8000	0.25	0.5	144.8	10
YAZ2D200	200	190	210	2.5	1900	9990	0.25	0.5	152	9

YAZ2Dxxx Series (SMA/DO-214AC)

▲ Features:

Total power dissipation: Max. 2W.
Wide zener reverse voltage range 3.3V to 200V.
The marking bar indicates the cathode

▲ Mechanical Data

Case: SMAG
Terminals: Solderable per MIL-STD-750, Method 2026

Absolute Maximum Ratings And Characteristics (Ta = 25 ° C)

Parameter	Symbol	Value	Unit
Power Dissipation	$P_d (T_L=75^\circ\text{C})$	2	W
Zener current	I_z	P_v/V_z	mA
Thermal resistance	$R_{\theta JA}$	75	$^\circ\text{C/W}$
	$R_{\theta JL}$	30	$^\circ\text{C/W}$
JForward voltage	$V_F(I_F=200\text{mA})$	1.2	V
Operating and Storage Temperature Range	T_j, T_{stg}	-65~+150	$^\circ\text{C}$

Electrical Characteristics (TA = 25 ° C)

Part Number	Nominal Zener Voltage @IT			IZT (mA)	Maximum Zener Impedance			Maximum Reverse Leakage Current		Maximum DC Zener Current
	Nom (V)	Min (V)	Max (V)		Zzt max.@Izt (Ω)	Zzt max.@Izt (Ω)	IZK(mA)	Ir(uA)@V R	VR(V)	
YAZ2D3V3	3.3	3.14	3.47	145	8	400	1	100	1	548
YAZ2D3V6	3.6	3.42	3.78	139	5	400	1	100	1	502
YAZ2D3V9	3.9	3.71	4.1	128	5	400	1	50	1	464
YAZ2D4V3	4.3	4.09	4.52	116	4.5	400	1	50	1	421
YAZ2D4V7	4.7	4.47	4.94	106	4.5	550	1	10	1	385
YAZ2D5V1	5.1	4.85	5.36	98	3.5	600	1	10	1	354
YAZ2D5V6	5.6	5.32	5.88	89.5	2.5	500	1	10	2	323
YAZ2D6V2	6.2	5.89	6.51	80.5	1.5	700	1	10	3	292
YAZ2D6V8	6.8	6.46	7.14	73.5	2	700	1	10	4	266
YAZ2D7V5	7.5	7.13	7.88	66.5	2	700	0.5	10	5	242
YAZ2D8V2	8.2	7.79	8.61	61	2.3	700	0.5	10	6	220
YAZ2D9V1	9.1	8.65	9.56	55	2.5	700	0.5	10	7	200

Part Number	Nominal Zener Voltage @IT			IZT (mA)	Maximum Zener Impedance			Maximum Reverse Leakage Current		Maximum DC Zener Current
	Nom (V)	Min (V)	Max (V)		Zzt max.@Izt (Ω)	Zzt max.@Izt (Ω)	IZK(mA)	Ir(uA)@V R	VR(V)	
YAZ2D10	10	9.5	10.5	50	3.5	700	0.25	10	7.6	182
YAZ2D11	11	10.45	11.55	45.5	4	700	0.25	1	8.4	166
YAZ2D12	12	11.4	12.6	41.5	4.5	700	0.25	1	9.1	152
YAZ2D13	13	12.35	13.65	38.5	5	700	0.25	0.5	9.9	138
YAZ2D14	14	13.3	14.7	35.7	5.5	700	0.25	0.5	10.6	130
YAZ2D15	15	14.25	15.75	33.4	7	700	0.25	0.5	11.4	122
YAZ2D16	16	15.2	16.8	31.2	8	700	0.25	0.5	12.2	114
YAZ2D17	17	16.15	17.85	29.4	9	750	0.25	0.5	13	107
YAZ2D18	18	17.1	18.9	27.8	10	750	0.25	0.5	13.7	100
YAZ2D19	19	18.05	19.95	26.3	11	750	0.25	0.5	14.4	95
YAZ2D20	20	19	21	25	11	750	0.25	0.5	15.2	90
YAZ2D22	22	20.9	23.1	22.8	12	750	0.25	0.5	16.7	82
YAZ2D24	24	22.8	25.2	20.8	13	750	0.25	0.5	18.2	76
YAZ2D27	27	25.65	28.35	18.5	18	750	0.25	0.5	20.6	68
YAZ2D30	30	28.5	31.5	16.6	20	1000	0.25	0.5	22.5	60
YAZ2D33	33	31.35	34.65	15.1	23	1000	0.25	0.5	25.1	55
YAZ2D36	36	34.2	37.8	13.9	25	1000	0.25	0.5	27.4	50
YAZ2D39	39	37.05	40.95	12.8	30	1000	0.25	0.5	29.7	47
YAZ2D43	43	40.85	45.15	11.6	35	1500	0.25	0.5	32.7	43
YAZ2D47	47	44.65	49.35	10.6	40	1500	0.25	0.5	35.8	39
YAZ2D51	51	48.45	53.55	9.8	48	1500	0.25	0.5	38.8	36
YAZ2D56	56	53.2	58.8	9	55	2000	0.25	0.5	42.6	32
YAZ2D62	62	58.9	65.1	8.1	60	2000	0.25	0.5	47.1	29
YAZ2D68	68	64.6	71.4	7.4	75	2000	0.25	0.5	51.7	27
YAZ2D75	75	71.25	78.75	6.7	90	2000	0.25	0.5	56	24
YAZ2D82	82	77.9	86.1	6.1	100	3000	0.25	0.5	62.2	22
YAZ2D91	91	86.45	95.55	5.5	125	3000	0.25	0.5	69.2	20
YAZ2D100	100	95	105	5	175	3000	0.25	0.5	76	18
YAZ2D110	110	104.5	115.5	4.5	250	4000	0.25	0.5	83.6	17
YAZ2D120	120	114	126	4.2	325	4500	0.25	0.5	91.2	15
YAZ2D130	130	123.5	136.5	3.8	400	5000	0.25	0.5	98.8	14
YAZ2D140	140	133	147	3.6	500	5500	0.25	0.5	106.4	13
YAZ2D150	150	142.5	157.5	3.3	575	6000	0.25	0.5	114	12
YAZ2D160	160	152	168	3.1	650	6500	0.25	0.5	121.6	11
YAZ2D170	170	161.5	178.5	2.9	675	7000	0.25	0.5	130.4	11
YAZ2D180	180	171	189	2.8	725	7000	0.25	0.5	136.8	10
YAZ2D190	190	180.5	199.5	2.6	825	8000	0.25	0.5	144.8	10
YAZ2D200	200	190	210	2.5	1900	9990	0.25	0.5	152	9

Package Outline

SOD123



UNIT		A	C	D	E	E1	L1	b	A1	\angle
mm	max	1.3	0.22	1.8	2.8	3.9	0.45	0.7	0.2	9°
	min	0.9	0.09	1.5	2.5	3.6	0.25	0.5	-	
mil	max	51	8.7	71	110	154	18	28	8	
	min	35	3.5	59	98	142	10	20	-	

SOD323

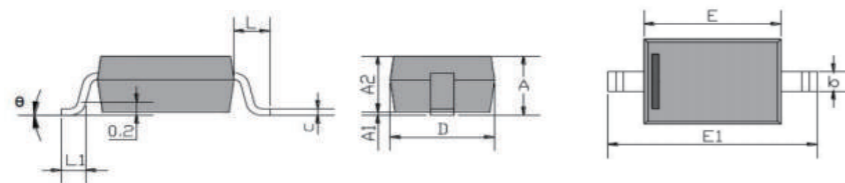

Symbol	A	A1	A2	B	C	D	E	E1	L	L1	θ	
Dimensions in mm	Min		0.000	0.800	0.250	0.080	1.200	1.600	2.500	0.475REF	0.250	0°
	Max	1.000	0.100	0.900	0.350	0.150	1.400	1.800	2.700		0.400	8°

SOD523

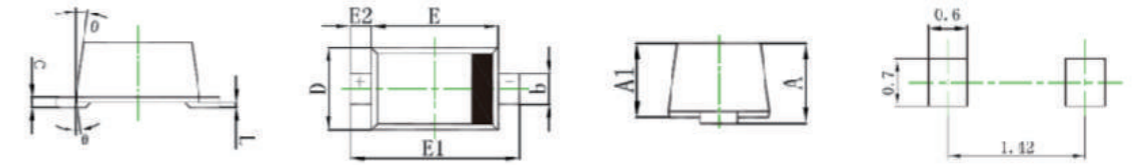

Symbol	A	A1	B	C	D	E	E1	E2	L	θ	
Dimensions in mm	Min	0.77	0.70	0.35	0.15	0.85	1.30	1.70	0.20REF	0.07	7°
	Max	0.51	0.50	0.25	0.08	0.75	1.10	1.50		0.01	

SMA/DO-214AC

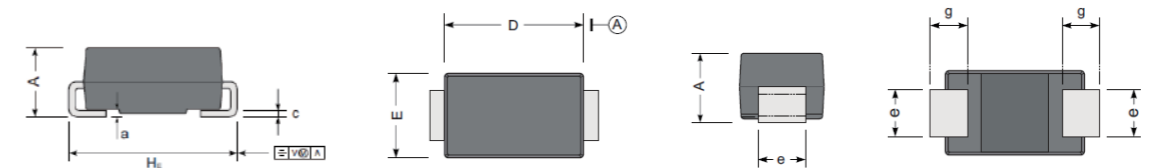

UNIT		A	D	E	He	c	e	g	a
mm	max	2.2	4.5	2.7	5.2	0.31	1.6	1.5	0.3
	min	1.9	4.0	2.3	4.7	0.15	1.3	0.9	
mil	max	87	181	106	205	12	63	59	12
	min	75	157	91	185	6	51	35	

Package Outline

SOD123



UNIT		A	C	D	E	E1	L1	b	A1	\angle
mm	max	1.3	0.22	1.8	2.8	3.9	0.45	0.7	0.2	9°
	min	0.9	0.09	1.5	2.5	3.6	0.25	0.5	-	
mil	max	51	8.7	71	110	154	18	28	8	
	min	35	3.5	59	98	142	10	20	-	

SOD323

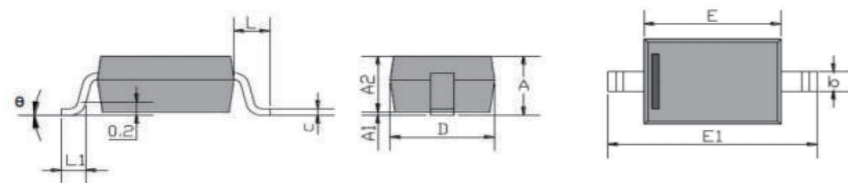

Symbol	A	A1	A2	B	C	D	E	E1	L	L1	θ	
Dimensions in mm	Min		0.000	0.800	0.250	0.080	1.200	1.600	2.500	0.475REF	0.250	0°
	Max	1.000	0.100	0.900	0.350	0.150	1.400	1.800	2.700		0.400	8°

SOD523

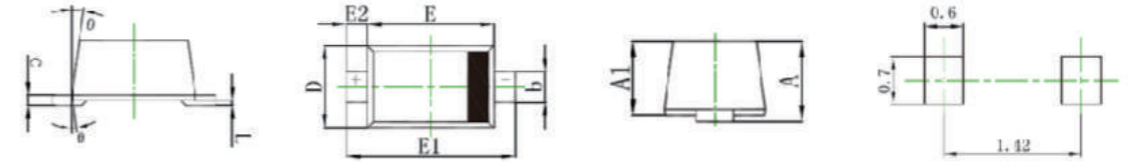

Symbol	A	A1	B	C	D	E	E1	E2	L	θ	
Dimensions in mm	Min	0.77	0.70	0.35	0.15	0.85	1.30	1.70	0.20REF	0.07	7°
	Max	0.51	0.50	0.25	0.08	0.75	1.10	1.50		0.01	

SMA/DO-214AC

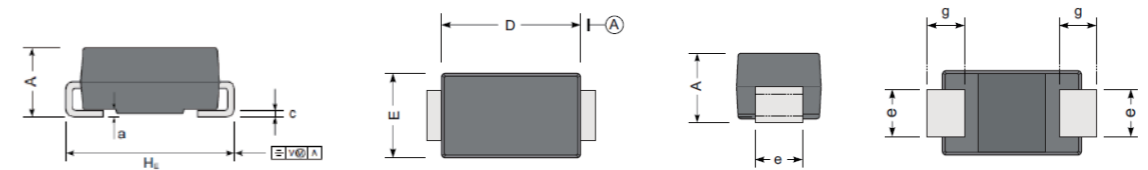

UNIT		A	D	E	He	c	e	g	a
mm	max	2.2	4.5	2.7	5.2	0.31	1.6	1.5	0.3
	min	1.9	4.0	2.3	4.7	0.15	1.3	0.9	
mil	max	87	181	106	205	12	63	59	12
	min	75	157	91	185	6	51	35	

场效应管 MOSFET(Metal Oxide Semiconductor Field Effect Transistor)

金属-氧化物半导体场效应晶体管 (Metal-Oxide-Semiconductor Field-Effect Transistor, MOSFET), 也简称为场效应管, 其利用多数载流子导电, 所以为单极型器件。

场效应晶体管是电压控制元件。

MOSFET的4种类型: P沟道增强型, P沟道耗尽型, N沟道增强型, N沟道耗尽型

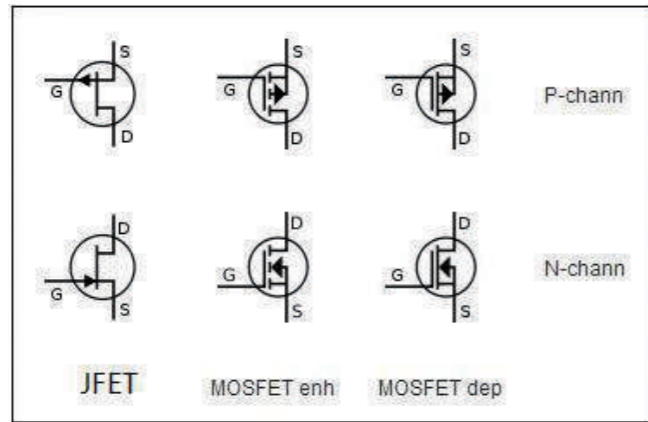

命名规则

1) VDMOS

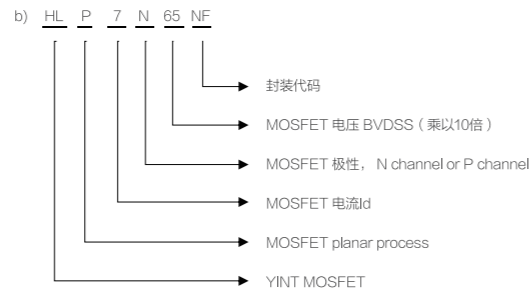
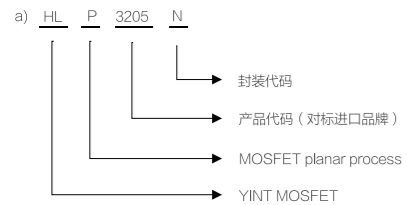

2) HLG3401A1N

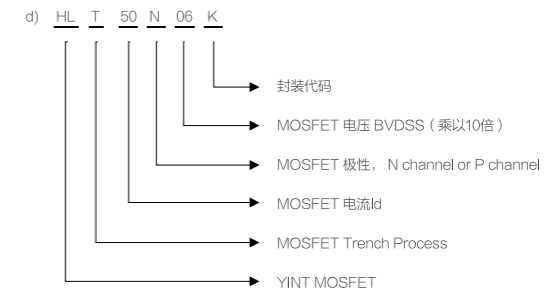
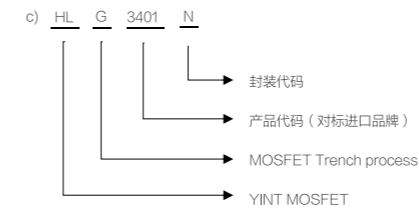

3) SGT (Shielded-Gate Trench) MOS

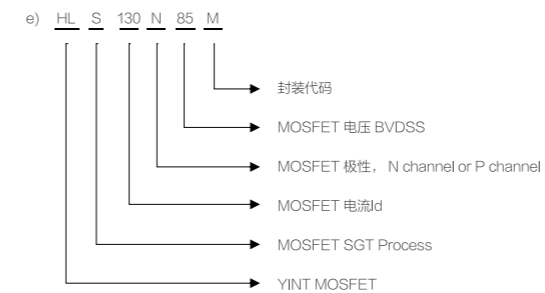

4) SJ (Super Junction) MOS

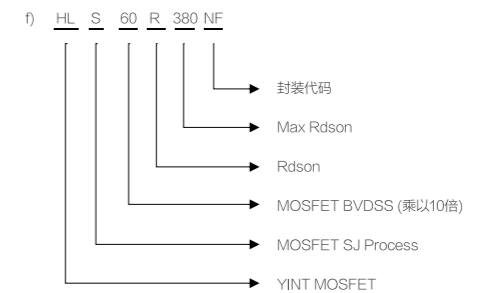

5) Dual MOS

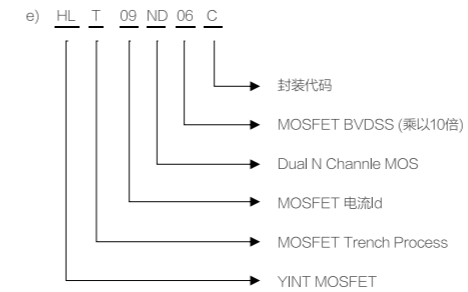

场效应管 MOSFET(Metal Oxide Semiconductor Field Effect Transistor)

金属-氧化物半导体场效应晶体管 (Metal-Oxide-Semiconductor Field-Effect Transistor, MOSFET), 也简称为场效应管, 其利用多数载流子导电, 所以为单极型器件。

场效应晶体管是电压控制元件。

MOSFET的4种类型: P沟道增强型, P沟道耗尽型, N沟道增强型, N沟道耗尽型

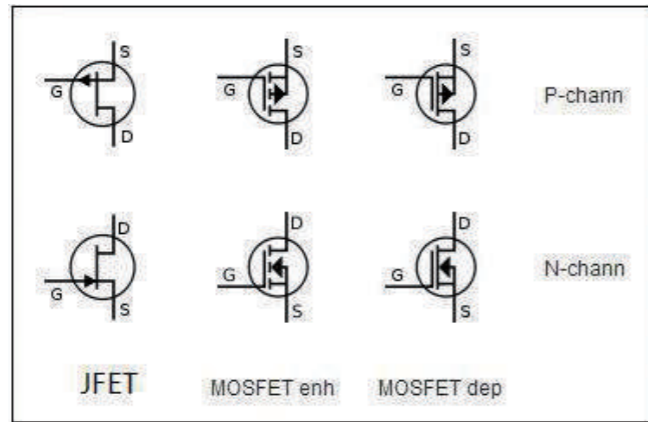

命名规则

1) VDMOS

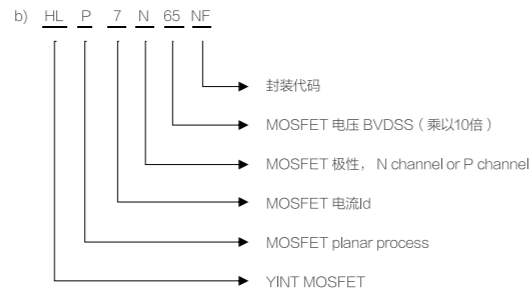
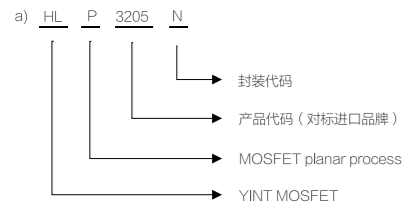

2) HLG3401A1N

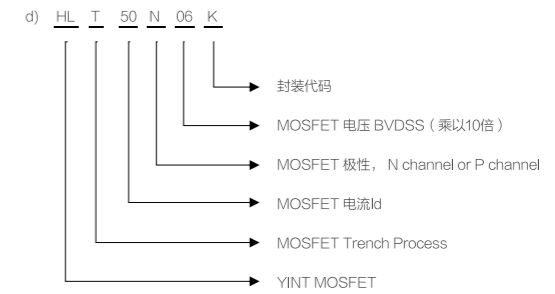
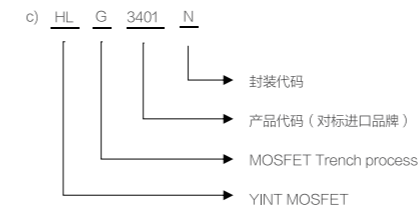

3) SGT (Shielded-Gate Trench) MOS

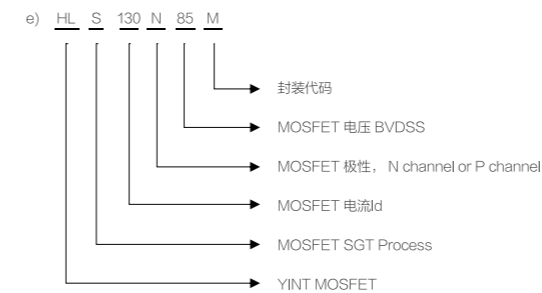

4) SJ (Super Junction) MOS

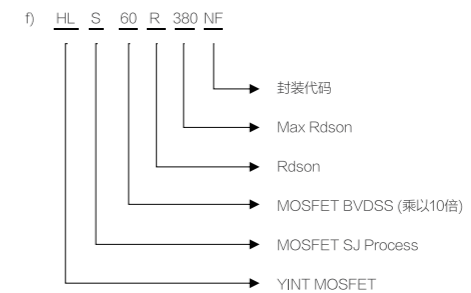

5) Dual MOS

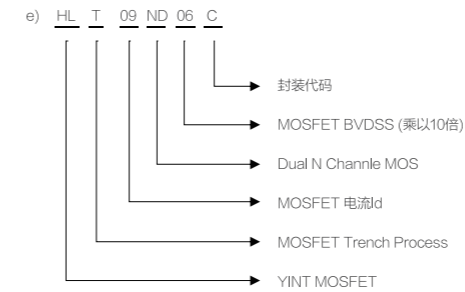

主要参数

V_{DS} :	Drain-Source Voltage	C_{rss} :	Reverse Transfer Capacitance
V_{GS} :	Gate-Source Voltage	Q_g :	Total Gate Charge
I_b :	Continuous Drain Current	Q_{gd} :	Gate-Drain Charge
BV_{DSS} :	Drain-Source Breakdown Voltage	Q_{gs} :	Gate-Source Charge
$V_{GS(th)}$:	Gate Threshold Voltage	$T_d(on)$:	Turn-on Delay Time
$R_{DS(on)}$:	Drain-Source On-State Resistance	T_r :	Turn-on Rise Time
I_{GSS} :	Gate-Body Leakage Current	$T_d(off)$:	Turn-off Delay Time
I_{DSS} :	Zero Gate Voltage Drain Current	T_f :	Turn-off fall Time
g_{fs} :	Forward Transconductance	T_{rr} :	Diodes Reverse Recovery Time
$V_{F_{DS}}$:	Diode Forward Voltage	Q_{rr} :	Diodes Reverse Recovery Charge
C_{iss} :	Input Capacitance	E_{AS} :	Avalanche energy, single pulse
C_{oss} :	Output Capacitance	R_g :	Gate resistance

作用

MOSFET 的三种工作状态：导通，截止和可变电阻区（线性工作区）。

- ▲ 做电平转换用
- ▲ 做开关管用
- ▲ 缓启动用
- ▲ 防反接用
- ▲ 做逻辑转换用
- ▲ 隔离
- ▲ 放大
- ▲ 驱动
- ▲ 控制

应用

- ▲ 消防：气体检测器、气体报警器、传感器、火焰探测器、防火门控制器、消防设备电源监控器、烟感探测器、光纤感温火灾探测器、消防远程控制系统
- ▲ 工控：打印机控制板、设备控制板、直流无刷控制、锂电保护板、园林工具
- ▲ 医疗：血液检测仪器、血糖仪、核酸检测仪器、超声波电源
- ▲ 驱动：马达控制应用、LED 灯具的驱动
- ▲ 照明：金卤灯整流器、LED照明电源、CCFL 节能灯、氙气灯整流器
- ▲ 电器：电源适配器、PC电源、家用产品电源、智能家居、智能锁
- ▲ 两轮三轮电动车：控制器、中控、仪表、
- ▲ 新能源电动车：充电桩、车载蓝牙、门窗控制器、BMS保护板
- ▲ 通信：UPS、设备电源、控制器
- ▲ 开关电源：仪器设备电源、充电器、

Trench MOSFET

Voltage	Part Name	$V_{(BR)DSS}$ (V)	I_b (A)	Configuration	$R_{DS(on)-typ}$ (m Ω) 10V	$R_{DS(on)-typ}$ (m Ω) 4.5V	$V_{GS(th)-min}$ (V)	$V_{GS(th)-max}$ (V)	Package
-12	HLG2301GA1N	-12	-2	Single	-	73	-0.4	-1	SOT-23
	HLG2305EA1N	-12	-4.1	Single	-	29	-0.45	-1	SOT-23
	HLT6P01A1N	-12	-6	Single	-	19	-0.4	-1	SOT-23
	HLT9P01C	-12	-9	Single	-	11.5	-0.4	-1	SOP8
-15	HLG3417A1N	-15	-4.5	Single	-	27	-0.45	-1	SOT-23
	HLG2301EA1N	-15	-2.6	Single	-	55	-0.4	-1	SOT-23
	HLG2301FA1N	-15	-3	Single	-	42	-0.4	-1	SOT-23
-20	HLG2305CA1N	-15	-5.6	Single	-	23	-0.4	-1	SOT-23
	HLG2301A1N	-20	-2.3	Single	-	90	-0.4	-1	SOT-23
	HLG2301BA1N	-20	-3	Single	-	58	-0.4	-1	SOT-23
	HLG2301CA1N	-20	-3.2	Single	-	49	-0.4	-1	SOT-23
	HLG2301DA1N	-20	-2	Single	-	120	-0.4	-1	SOT-23
	HLG2305A1N	-20	-5	Single	-	32	-0.4	-1	SOT-23
	HLG2305A6	-20	-5	Single	-	32	-0.4	-1	SOT-23-6
	HLG3415A1N	-20	-4	Single	-	31	-0.4	-1	SOT-23
	HLT7P02A1N	-20	-7	Single	-	20	-0.4	-1	SOT-23
	HLT13P02C	-20	-13	Single	-	13	-0.4	-1	SOP-8L
	HLT50P02K	-20	-50	Single	-	6.6	-0.4	-1	TO-252
	-30	HLG3453A1N	-30	-2	Single	115	150	-1	-2.5
HLG2303A1N		-30	-2.6	Single	72	110	-1	-2.5	SOT-23
HLG2303BA1N		-30	-3	Single	55	80	-1	-2.5	SOT-23
HLG3407A1N		-30	-4.3	Single	42	50	-1	-2.5	SOT-23
HLG3401A1N		-30	-4.3	Single	40	46	-0.4	-1	SOT-23
HLG9435C		-30	-5	Single	30	46	-1	-2.5	SOP-8L
HLG4449C		-30	-7	Single	25	37	-1	-2.5	SOP-8L
HLT8P03C		-30	-8	Single	19	27	-1	-2.5	SOP-8L
HLT9P03C		-30	-9	Single	15	20	-1	-2.5	SOP-8L
HLG4435C		-30	-10	Single	13	18	-1	-2.5	SOP-8L
HLT10P03C		-30	-10	Single	13	18	-1	-2.5	SOP-8L
HLG4407C		-30	-12	Single	9.5	14	-1	-2.5	SOP-8L
HLT12P03C		-30	-12	Single	9.5	14	-1	-2.5	SOP-8L
HLT15P03C		-30	-15	Single	8.5	11.5	-1	-2.5	SOP-8L
HLT18P03C		-30	-18	Single	5	6.2	-1	-2.5	SOP-8L
HLT15P03		-30	-15	Single	19	27	-1	-2.5	TO-252,TO-251
HLT20P03		-30	-20	Single	16	23	-1	-2.5	TO-252,TO-251
HLT30P03		-30	-30	Single	13	19	-1	-2.5	TO-252,TO-251
HLT40P03		-30	-40	Single	9.5	14	-1	-2.5	TO-252,TO-251
HLT50P03		-30	-50	Single	7.5	11.5	-1	-2.5	TO-252,TO-251
HLT60P03	-30	-60	Single	6	9	-1	-2.5	TO-252,TO-251	
HLT70P03	-30	-70	Single	5	7.5	-1	-2.5	TO-252,TO-251	
HLT30P03PF5	-30	-30	Single	13	19	-1	-2.5	PDFN5060-8L	
HLT40P03PF5	-30	-40	Single	9	14	-1	-2.5	PDFN5060-8L	
HLT50P03PF5	-30	-50	Single	6	9	-1	-2.5	PDFN5060-8L	
HLT60P03PF5	-30	-60	Single	5	7.5	-1	-2.5	PDFN5060-8L	
HLT30P03PF4	-30	-30	Single	16	22	-1	-2.5	PDFN3333-8L	

主要参数

V_{DS} :	Drain-Source Voltage	C_{rss} :	Reverse Transfer Capacitance
V_{GS} :	Gate-Source Voltage	Q_g :	Total Gate Charge
I_b :	Continuous Drain Current	Q_{gd} :	Gate-Drain Charge
BV_{DSS} :	Drain-Source Breakdown Voltage	Q_{gs} :	Gate-Source Charge
$V_{GS(th)}$:	Gate Threshold Voltage	$T_d(on)$:	Turn-on Delay Time
$R_{DS(on)}$:	Drain-Source On-State Resistance	T_r :	Turn-on Rise Time
I_{GSS} :	Gate-Body Leakage Current	$T_d(off)$:	Turn-off Delay Time
I_{DSS} :	Zero Gate Voltage Drain Current	T_f :	Turn-off fall Time
g_{fs} :	Forward Transconductance	T_{rr} :	Diodes Reverse Recovery Time
$V_{F_{DS}}$:	Diode Forward Voltage	Q_{rr} :	Diodes Reverse Recovery Charge
C_{iss} :	Input Capacitance	E_{AS} :	Avalanche energy, single pulse
C_{oss} :	Output Capacitance	R_g :	Gate resistance

作用

MOSFET 的三种工作状态：导通，截止和可变电阻区（线性工作区）。

- ▲ 做电平转换用
- ▲ 做开关管用
- ▲ 缓启动用
- ▲ 防反接用
- ▲ 做逻辑转换用
- ▲ 隔离
- ▲ 放大
- ▲ 驱动
- ▲ 控制

应用

- ▲ 消防：气体检测器、气体报警器、传感器、火焰探测器、防火门控制器、消防设备电源监控器、烟感探测器、光纤感温火灾探测器、消防远程控制系统
- ▲ 工控：打印机控制板、设备控制板、直流无刷控制、锂电保护板、园林工具
- ▲ 医疗：血液检测仪器、血糖仪、核酸检测仪器、超声波电源
- ▲ 驱动：马达控制应用、LED 灯具的驱动
- ▲ 照明：金卤灯整流器、LED照明电源、CCFL 节能灯、氙气灯整流器
- ▲ 电器：电源适配器、PC电源、家用产品电源、智能家居、智能锁
- ▲ 两轮三轮电动车：控制器、中控、仪表、
- ▲ 新能源电动车：充电桩、车载蓝牙、门窗控制器、BMS保护板
- ▲ 通信：UPS、设备电源、控制器
- ▲ 开关电源：仪器设备电源、充电器、

Trench MOSFET

Voltage	Part Name	$V_{(BR)DSS}$ (V)	I_b (A)	Configuration	$R_{DS(on)-typ}$ (m Ω) 10V	$R_{DS(on)-typ}$ (m Ω) 4.5V	$V_{GS(th)-min}$ (V)	$V_{GS(th)-max}$ (V)	Package	
-12	HLG2301GA1N	-12	-2	Single	-	73	-0.4	-1	SOT-23	
	HLG2305EA1N	-12	-4.1	Single	-	29	-0.45	-1	SOT-23	
	HLT6P01A1N	-12	-6	Single	-	19	-0.4	-1	SOT-23	
	HLT9P01C	-12	-9	Single	-	11.5	-0.4	-1	SOP8	
-15	HLG3417A1N	-15	-4.5	Single	-	27	-0.45	-1	SOT-23	
	HLG2301EA1N	-15	-2.6	Single	-	55	-0.4	-1	SOT-23	
	HLG2301FA1N	-15	-3	Single	-	42	-0.4	-1	SOT-23	
-20	HLG2305CA1N	-15	-5.6	Single	-	23	-0.4	-1	SOT-23	
	HLG2301A1N	-20	-2.3	Single	-	90	-0.4	-1	SOT-23	
	HLG2301BA1N	-20	-3	Single	-	58	-0.4	-1	SOT-23	
	HLG2301CA1N	-20	-3.2	Single	-	49	-0.4	-1	SOT-23	
	HLG2301DA1N	-20	-2	Single	-	120	-0.4	-1	SOT-23	
	HLG2305A1N	-20	-5	Single	-	32	-0.4	-1	SOT-23	
	HLG2305A6	-20	-5	Single	-	32	-0.4	-1	SOT-23-6	
	HLG3415A1N	-20	-4	Single	-	31	-0.4	-1	SOT-23	
	HLT7P02A1N	-20	-7	Single	-	20	-0.4	-1	SOT-23	
	HLT13P02C	-20	-13	Single	-	13	-0.4	-1	SOP-8L	
	HLT50P02K	-20	-50	Single	-	6.6	-0.4	-1	TO-252	
	-30	HLG3453A1N	-30	-2	Single	115	150	-1	-2.5	SOT-23
		HLG2303A1N	-30	-2.6	Single	72	110	-1	-2.5	SOT-23
		HLG2303BA1N	-30	-3	Single	55	80	-1	-2.5	SOT-23
HLG3407A1N		-30	-4.3	Single	42	50	-1	-2.5	SOT-23	
HLG3401A1N		-30	-4.3	Single	40	46	-0.4	-1	SOT-23	
HLG9435C		-30	-5	Single	30	46	-1	-2.5	SOP-8L	
HLG4449C		-30	-7	Single	25	37	-1	-2.5	SOP-8L	
HLT8P03C		-30	-8	Single	19	27	-1	-2.5	SOP-8L	
HLT9P03C		-30	-9	Single	15	20	-1	-2.5	SOP-8L	
HLG4435C		-30	-10	Single	13	18	-1	-2.5	SOP-8L	
HLT10P03C		-30	-10	Single	13	18	-1	-2.5	SOP-8L	
HLG4407C		-30	-12	Single	9.5	14	-1	-2.5	SOP-8L	
HLT12P03C		-30	-12	Single	9.5	14	-1	-2.5	SOP-8L	
HLT15P03C		-30	-15	Single	8.5	11.5	-1	-2.5	SOP-8L	
HLT18P03C		-30	-18	Single	5	6.2	-1	-2.5	SOP-8L	
HLT15P03		-30	-15	Single	19	27	-1	-2.5	TO-252,TO-251	
HLT20P03		-30	-20	Single	16	23	-1	-2.5	TO-252,TO-251	
HLT30P03		-30	-30	Single	13	19	-1	-2.5	TO-252,TO-251	
HLT40P03		-30	-40	Single	9.5	14	-1	-2.5	TO-252,TO-251	
HLT50P03		-30	-50	Single	7.5	11.5	-1	-2.5	TO-252,TO-251	
HLT60P03	-30	-60	Single	6	9	-1	-2.5	TO-252,TO-251		
HLT70P03	-30	-70	Single	5	7.5	-1	-2.5	TO-252,TO-251		
HLT30P03PF5	-30	-30	Single	13	19	-1	-2.5	PDFN5060-8L		
HLT40P03PF5	-30	-40	Single	9	14	-1	-2.5	PDFN5060-8L		
HLT50P03PF5	-30	-50	Single	6	9	-1	-2.5	PDFN5060-8L		
HLT60P03PF5	-30	-60	Single	5	7.5	-1	-2.5	PDFN5060-8L		
HLT30P03PF4	-30	-30	Single	16	22	-1	-2.5	PDFN3333-8L		

Trench MOSFET

Voltage	Part Name	V _{BR(DSS)} (V)	I _b (A)	Configuration	RDS(on)-typ (mΩ) 10V	RDS(on)-typ (mΩ) 4.5V	V _{GS(th)-min} (V)	V _{GS(th)-max} (V)	Package	
-30	HLT40P03PF4	-30	-40	Single	9.5	15.5	-1	-2.5	PDFN3333-8L	
	HLT50P03PF4	-30	-50	Single	5	6.9	-1	-2.5	PDFN3333-8L	
	HLT5P04	-40	-5	Single	65	85	-1	-2.5	SOT-23,SOP-8L	
	HLT7P04C	-40	-7	Single	40	55	-1	-2.5	SOP-8L	
	HLT9P04C	-40	-9	Single	36	47	-1	-2.5	SOP-8L	
-40	HLT15P04	-40	-15	Single	27	40	-1	-2.5	TO-252,TO-251	
	HLT40P04	-40	-40	Single	10	15	-1	-2.5	TO-252,TO-251	
	HLT70P04	-40	-70	Single	7.5	11.5	-1	-2.5	TO-252,TO-251	
	HLT15P04C	-40	-15	Single	40	55	-1	-2.5	PDFN3333-8L	
	HLT20P04C	-40	-20	Single	36	47	-1	-2.5	PDFN3333-8L	
	HLT25P04	-40	-25	Single	27	40	-1	-2.5	PDFN5060-8L	
	HLT55P04	-40	-55	Single	10	15	-1	-2.5	PDFN5060-8L	
	HLT90P04	-40	-90	Single	7.5	11.5	-1	-2.5	PDFN5060-8L	
	HLT15P55	-55	-15	Single	60	-	-2	-4	TO-252,TO-251	
	HLT30P55	-55	-30	Single	31	-	-2	-4	TO-220,TO-263,TO-252,TO-251	
-60	HLT4P06	-60	-4	Single	100	-	-1	-2.5	SOT-23, SOT-223,SOT-23-3,SOP-8L	
	HLT5P06	-60	-5	Single	80	-	-1	-2.5	SOT-23, SOT-223,SOT-23-3,SOP-8L	
	HLT10P06	-60	-10	Single	100	-	-1	-2.5	TO-252,TO-251	
	HLT12P06	-60	-12	Single	80	-	-1	-2.5	TO-252,TO-251	
	HLT18P06	-60	-18	Single	45	-	-1	-2.5	TO-252,TO-251	
-100	HLT30P06	-60	-30	Single	30	-	-1	-2.5	TO-252,TO-251	
	HLT50P06	-60	-50	Single	22	-	-1	-2.5	TO-252,TO-251	
	HLT4P10	-100	-4	Single	170	200	-1	-2.5	SOT-223, SOP-8L	
	HLT13P10	-100	-13	Single	170	200	-1	-2.5	TO-252,TO-251	
	HLT18P10	-100	-18	Single	85	95	-1	-2.5	TO-252,TO-251	
20	HLT30P10	-100	-30	Single	44	48	-1	-2.5	TO-252,TO-251,TO-220,TO-263	
	HLG3134	20	0.75	Single	-	165	0.35	1.1	SOT-23,SOT-323,SOT-523,SOT-723	
	HLG2302B	20	3	Single	-	38	0.55	1.25	SOT-23	
	HLG8205A6	20	6	Single	-	18	0.45	1	SOT-23-6	
	HLG2300	20	4.5	Single	-	20	0.45	1	SOT-23	
	HLG2302	20	4.3	Single	-	21	0.55	1.25	SOT-23	
	HLT10N02	20	10	Single	-	11	0.45	1	SOP-8L	
	HLG3416E	20	7	Single	-	13	0.45	1	SOT-23	
	HLT30N02	20	30	Single	-	6.5	0.45	1	TO-252	
	HLT60N02	20	60	Single	-	4.5	0.45	1	TO-252	
	HLT90N02PF4	20	60	Single	-	2.8	0.45	1	PDFN3333-8L	
	HLT90N02	20	90	Single	-	2.8	0.45	1	TO-252	
	HLT180N02	20	180	Single	-	1.8	0.45	1	TO-252	
	30	HLG3400	30	5.6	Single	20	24	0.65	1.5	SOT-23
		HLG3404	30	5.6	Single	17	26	1	2.5	SOT-23
HLT9N03C		30	9	Single	13	21	1	2.5	SOP-8L	
HLT12N03C		30	12	Single	7	11	1	2.5	SOP-8L	
HLT45N03		30	45	Single	6.5	10.5	1	2.5	TO-252,PDFN3333-8L	
HLT15N03C		30	15	Single	4.8	6.6	1	2.5	SOP-8L	
HLT60N03		30	60	Single	4.5	6.2	1	2.5	TO-252,PDFN3333-8L	

Trench MOSFET

Voltage	Part Name	V _{BR(DSS)} (V)	I _b (A)	Configuration	RDS(on)-typ (mΩ) 10V	RDS(on)-typ (mΩ) 4.5V	V _{GS(th)-min} (V)	V _{GS(th)-max} (V)	Package
30	HLT30N03	30	30	Single	9	15	1	2.5	TO-252,TO-251
	HLT40N03	30	40	Single	7.5	11.5	1	2.5	TO-252,TO-251
	HLT50N03	30	50	Single	6	9	1	2.5	TO-252,TO-251
	HLT80N03	30	80	Single	4.5	7.5	1	2.5	TO-252,TO-251
	HLT100N03	30	100	Single	3.3	6	1	2.5	TO-252,TO-251
	HLT120N03	30	120	Single	2.9	4.8	1	2.5	TO-252,TO-220,TO-263
	HLT150N03	30	150	Single	2.3	4.2	1	2.5	TO-252,TO-220,TO-263
	HLT150N03PF5	30	150	Single	2	3.6	1	2.5	PDFN5060-8L
	HLT180N03	30	180	Single	2	3.5	1	2.5	TO-252,TO-220,TO-263
	HLT180N03PF5	30	180	Single	1.6	3	1	2.5	PDFN5060-8L
	HLT200N03	30	200	Single	1.4	2.3	1	2.5	TO-252,TO-220,TO-263
	HLT200N03PF5	30	200	Single	1.1	2	1	2.5	PDFN5060-8L
	HLT5N04A1N	40	5	Single	30	40	1	2.5	SOT-23
	HLT7N04C	40	7	Single	30	40	1	2.5	SOP-8L
	40	HLT9N04C	40	9	Single	18	25	1	2.5
HLT10N04C		40	10	Single	15	20	1	2.5	SOP-8L
HLT11N04C		40	11	Single	12	15	1	2.5	SOP-8L
HLT40N04		40	40	Single	12	15	1	2.5	TO-252,PDFN3333-8L
HLT12N04C		40	12	Single	7.5	11	1	2.5	SOP-8L
HLT50N04		40	50	Single	7.5	11	1	2.5	TO-252,PDFN3333-8L
HLT60N04		40	60	Single	6	9	1	2.5	TO-252,PDFN3333-8L
HLT70N04		40	70	Single	5	6.5	1	2.5	TO-252,TO-220,TO-263
HLT80N04		40	80	Single	4.5	6	1	2.5	TO-252,TO-220,TO-263
HLT100N04		40	100	Single	3.3	4.8	1	2.5	TO-252,TO-220,TO-263
HLT120N04		40	120	Single	2.9	4	1	2.5	TO-252,TO-220,TO-263, PDFN5060-8L
HLT150N04		40	150	Single	2.5	3.5	1	2.5	TO-252,TO-220,TO-263, PDFN5060-8L
HLT180N04		40	180	Single	2	3	1	2.5	TO-252,TO-220,TO-263, PDFN5060-8L
HLT200N04		40	200	Single	1	-	2	4	TO-220,TO-247
50		HLG138	50	0.34	Single	1100	1300	1	2
	HLG7002	60	0.3	Single	1100	1300	1	2	SOT-23, SOT-323
	HLG7002E	60	0.3	Single	1100	1300	1	2	SOT-23, SOT-323
	HLT3N06	60	3	Single	85	95	1	2	SOT-23
	HLT10N06	60	10	Single	38	46	1	2.5	TO-252, SOP-8L
	HLT5N06	60	5	Single	26	33	1	2.5	SOT-223,SOP-8L
	HLT15N06	60	15	Single	26	33	1	2.5	TO-252, SOP-8L
	HLT20N06	60	20	Single	21	28	1	2.5	TO-252, TO-251
	HLT6N06	60	6	Single	21	28	1	2.5	SOT-223,SOP-8L
	HLT30N06	60	30	Single	18	24	1	2.5	TO-252, TO-251
	HLT50N06	60	50	Single	12	16	1	2.5	TO-252, TO-220, TO-251
	HLT9N06	60	9	Single	12	16	1	2.5	SOT-223,SOP-8L
	HLT30N06PF5	60	30	Single	12	16	1	2.5	PDFN5060-8L
	HLT60N06	60	60	Single	8	10	1	2.5	TO-252, TO-220, TO-251,TO-263
	HLT70N06	60	70	Single	7.2	-	2	4	TO-220, TO-263
60	HLT80N06	60	80	Single	5.8	7.5	1	2.5	TO-252, TO-220, TO-251,TO-263
	HLT120N06	60	120	Single	4.8	-	2	4	TO-252, TO-220, TO-251,TO-263

Trench MOSFET

Voltage	Part Name	V _{BR(DSS)} (V)	I _b (A)	Configuration	RDS(on)-typ (mΩ) 10V	RDS(on)-typ (mΩ) 4.5V	V _{GS(th)-min} (V)	V _{GS(th)-max} (V)	Package
-30	HLT40P03PF4	-30	-40	Single	9.5	15.5	-1	-2.5	PDFN3333-8L
	HLT50P03PF4	-30	-50	Single	5	6.9	-1	-2.5	PDFN3333-8L
	HLT5P04	-40	-5	Single	65	85	-1	-2.5	SOT-23,SOP-8L
	HLT7P04C	-40	-7	Single	40	55	-1	-2.5	SOP-8L
	HLT9P04C	-40	-9	Single	36	47	-1	-2.5	SOP-8L
-40	HLT15P04	-40	-15	Single	27	40	-1	-2.5	TO-252,TO-251
	HLT40P04	-40	-40	Single	10	15	-1	-2.5	TO-252,TO-251
	HLT70P04	-40	-70	Single	7.5	11.5	-1	-2.5	TO-252,TO-251
	HLT15P04C	-40	-15	Single	40	55	-1	-2.5	PDFN3333-8L
	HLT20P04C	-40	-20	Single	36	47	-1	-2.5	PDFN3333-8L
	HLT25P04	-40	-25	Single	27	40	-1	-2.5	PDFN5060-8L
	HLT55P04	-40	-55	Single	10	15	-1	-2.5	PDFN5060-8L
	HLT90P04	-40	-90	Single	7.5	11.5	-1	-2.5	PDFN5060-8L
	HLT15P55	-55	-15	Single	60	-	-2	-4	TO-252,TO-251
	HLT30P55	-55	-30	Single	31	-	-2	-4	TO-220,TO-263,TO-252,TO-251
-55	HLT4P06	-60	-4	Single	100	-	-1	-2.5	SOT-23, SOT-223,SOT-23-3,SOP-8L
	HLT5P06	-60	-5	Single	80	-	-1	-2.5	SOT-23, SOT-223,SOT-23-3,SOP-8L
	HLT10P06	-60	-10	Single	100	-	-1	-2.5	TO-252,TO-251
	HLT12P06	-60	-12	Single	80	-	-1	-2.5	TO-252,TO-251
	HLT18P06	-60	-18	Single	45	-	-1	-2.5	TO-252,TO-251
-60	HLT30P06	-60	-30	Single	30	-	-1	-2.5	TO-252,TO-251
	HLT50P06	-60	-50	Single	22	-	-1	-2.5	TO-252,TO-251
	HLT4P10	-100	-4	Single	170	200	-1	-2.5	SOT-223, SOP-8L
	HLT13P10	-100	-13	Single	170	200	-1	-2.5	TO-252,TO-251
	HLT18P10	-100	-18	Single	85	95	-1	-2.5	TO-252,TO-251
-100	HLT30P10	-100	-30	Single	44	48	-1	-2.5	TO-252,TO-251,TO-220,TO-263
	HLG3134	20	0.75	Single	-	165	0.35	1.1	SOT-23,SOT-323,SOT-523,SOT-723
	HLG2302B	20	3	Single	-	38	0.55	1.25	SOT-23
	HLG8205A6	20	6	Single	-	18	0.45	1	SOT-23-6
	HLG2300	20	4.5	Single	-	20	0.45	1	SOT-23
	HLG2302	20	4.3	Single	-	21	0.55	1.25	SOT-23
	HLT10N02	20	10	Single	-	11	0.45	1	SOP-8L
	HLG3416E	20	7	Single	-	13	0.45	1	SOT-23
	HLT30N02	20	30	Single	-	6.5	0.45	1	TO-252
	HLT60N02	20	60	Single	-	4.5	0.45	1	TO-252
20	HLT90N02PF4	20	60	Single	-	2.8	0.45	1	PDFN3333-8L
	HLT90N02	20	90	Single	-	2.8	0.45	1	TO-252
	HLT180N02	20	180	Single	-	1.8	0.45	1	TO-252
	HLG3400	30	5.6	Single	20	24	0.65	1.5	SOT-23
	HLG3404	30	5.6	Single	17	26	1	2.5	SOT-23
	HLT9N03C	30	9	Single	13	21	1	2.5	SOP-8L
	HLT12N03C	30	12	Single	7	11	1	2.5	SOP-8L
	HLT45N03	30	45	Single	6.5	10.5	1	2.5	TO-252,PDFN3333-8L
	HLT15N03C	30	15	Single	4.8	6.6	1	2.5	SOP-8L
	HLT60N03	30	60	Single	4.5	6.2	1	2.5	TO-252,PDFN3333-8L

Trench MOSFET

Voltage	Part Name	V _{BR(DSS)} (V)	I _b (A)	Configuration	RDS(on)-typ (mΩ) 10V	RDS(on)-typ (mΩ) 4.5V	V _{GS(th)-min} (V)	V _{GS(th)-max} (V)	Package
30	HLT30N03	30	30	Single	9	15	1	2.5	TO-252,TO-251
	HLT40N03	30	40	Single	7.5	11.5	1	2.5	TO-252,TO-251
	HLT50N03	30	50	Single	6	9	1	2.5	TO-252,TO-251
	HLT80N03	30	80	Single	4.5	7.5	1	2.5	TO-252,TO-251
	HLT100N03	30	100	Single	3.3	6	1	2.5	TO-252,TO-251
	HLT120N03	30	120	Single	2.9	4.8	1	2.5	TO-252,TO-220,TO-263
	HLT150N03	30	150	Single	2.3	4.2	1	2.5	TO-252,TO-220,TO-263
	HLT150N03PF5	30	150	Single	2	3.6	1	2.5	PDFN5060-8L
	HLT180N03	30	180	Single	2	3.5	1	2.5	TO-252,TO-220,TO-263
	HLT180N03PF5	30	180	Single	1.6	3	1	2.5	PDFN5060-8L
	HLT200N03	30	200	Single	1.4	2.3	1	2.5	TO-252,TO-220,TO-263
	HLT200N03PF5	30	200	Single	1.1	2	1	2.5	PDFN5060-8L
	HLT5N04A1N	40	5	Single	30	40	1	2.5	SOT-23
	HLT7N04C	40	7	Single	30	40	1	2.5	SOP-8L
	40	HLT9N04C	40	9	Single	18	25	1	2.5
HLT10N04C		40	10	Single	15	20	1	2.5	SOP-8L
HLT11N04C		40	11	Single	12	15	1	2.5	SOP-8L
HLT40N04		40	40	Single	12	15	1	2.5	TO-252,PDFN3333-8L
HLT12N04C		40	12	Single	7.5	11	1	2.5	SOP-8L
HLT50N04		40	50	Single	7.5	11	1	2.5	TO-252,PDFN3333-8L
HLT60N04		40	60	Single	6	9	1	2.5	TO-252,PDFN3333-8L
HLT70N04		40	70	Single	5	6.5	1	2.5	TO-252,TO-220,TO-263
HLT80N04		40	80	Single	4.5	6	1	2.5	TO-252,TO-220,TO-263
HLT100N04		40	100	Single	3.3	4.8	1	2.5	TO-252,TO-220,TO-263
HLT120N04		40	120	Single	2.9	4	1	2.5	TO-252,TO-220,TO-263, PDFN5060-8L
HLT150N04		40	150	Single	2.5	3.5	1	2.5	TO-252,TO-220,TO-263, PDFN5060-8L
HLT180N04		40	180	Single	2	3	1	2.5	TO-252,TO-220,TO-263, PDFN5060-8L
HLT200N04		40	200	Single	1	-	2	4	TO-220,TO-247
50		HLG138	50	0.34	Single	1100	1300	1	2
	HLG7002	60	0.3	Single	1100	1300	1	2	SOT-23, SOT-323
	HLG7002E	60	0.3	Single	1100	1300	1	2	SOT-23, SOT-323
	HLT3N06	60	3	Single	85	95	1	2	SOT-23
	HLT10N06	60	10	Single	38	46	1	2.5	TO-252, SOP-8L
	HLT5N06	60	5	Single	26	33	1	2.5	SOT-223,SOP-8L
	HLT15N06	60	15	Single	26	33	1	2.5	TO-252, SOP-8L
	HLT20N06	60	20	Single	21	28	1	2.5	TO-252, TO-251
	HLT6N06	60	6	Single	21	28	1	2.5	SOT-223,SOP-8L
	HLT30N06	60	30	Single	18	24	1	2.5	TO-252, TO-251
	HLT50N06	60	50	Single	12	16	1	2.5	TO-252, TO-220, TO-251
	HLT9N06	60	9	Single	12	16	1	2.5	SOT-223,SOP-8L
	HLT30N06PF5	60	30	Single	12	16	1	2.5	PDFN5060-8L
	HLT60N06	60	60	Single	8	10	1	2.5	TO-252, TO-220, TO-251,TO-263
	HLT70N06	60	70	Single	7.2	-	2	4	TO-220, TO-263
60	HLT80N06	60	80	Single	5.8	7.5	1	2.5	TO-252, TO-220, TO-251,TO-263
	HLT120N06	60	120	Single	4.8	-	2	4	TO-252, TO-220, TO-251,TO-263

Trench MOSFET

Voltage	Part Name	V _{BRIDSS} (V)	I _b (A)	Configuration	RDS(on)-typ (mΩ) 10V	RDS(on)-typ (mΩ) 4.5V	V _{GS(th)-min} (V)	V _{GS(th)-max} (V)	Package
60	HLT150N06	60	150	Single	3.2	-	2	4	TO-220, TO-263
	HLT200N06	60	200	Single	2.5	-	2	4	TO-220, TO-263
68	HLT78N07	68	78	Single	6.6	-	2	4	TO-252, TO-220, TO-251, TO-263
	HLT95N07	68	95	Single	5.8	-	2	4	TO-220, TO-263
	HLT120N07	68	120	Single	5	-	2	4	TO-220, TO-263
75	HLT140N07	68	140	Single	3.5	-	2	4	TO-220, TO-263
	HLT210N75	75	210	Single	3	-	2	4	TO-220, TO-263
80	HLT60N08	80	60	Single	11	-	2	4	TO-252, TO-220, TO-251, TO-263
	HLT70N08	80	70	Single	10	-	2	4	TO-252, TO-220, TO-251, TO-263
	HLT80N08	80	80	Single	7	7.8	1	2.5	TO-252, TO-220, TO-251, TO-263
	HLT80NH08	80	80	Single	7.5	-	2	4	TO-252, TO-220, TO-251, TO-263
	HLT140N08	80	140	Single	5	-	2	4	TO-220, TO-263
	HLT200N08	80	200	Single	3	-	2	4	TO-220, TO-263
	HLT250N08	80	250	Single	1.9	-	2	4	TO-220, TO-263
100	HLT320N08	80	320	Single	1.3	-	2	4	TO-247
	HLG123A1N	100	0.2	Single	3000	3500	1	2.5	SOT-23, SOT-323
	HLT2N10	100	2	Single	250	260	1	2.5	SOT-23
	HLT15N10	100	15	Single	94	100	1	2.5	TO-252, TO-251
	HLT17N10	100	17	Single	55	65	1	2.5	TO-252, TO-251, PDFN3333-8L
	HLT30N10	100	30	Single	24	27	1	2.5	TO-252, TO-251
	HLT8N10	100	8	Single	24	27	1	2.5	SOT-223
	HLT50N10	100	50	Single	17	-	2	4	TO-220, TO-263
	HLT20N10	100	20	Single	14	17	1	2.5	SOP-8L
	HLT60N10	100	60	Single	14	-	2	4	TO-220, TO-263
	HLT120N10	100	120	Single	7	-	2	4	TO-220, TO-263
	HLT140N10	100	140	Single	5	-	2	4	TO-220, TO-263
	HLT180N10	100	180	Single	4	-	2	4	TO-220, TO-263
150	HLT2N15	150	2	Single	260	320	1	2.5	SOT-23, SOT-223, SOP-8L
	HLT20N15	150	20	Single	65	-	2	4	TO-252, TO-251
	HLT5N15	150	5	Single	30	40	1	2.5	SOT-223, SOP-8L
	HLT40N15	150	40	Single	30	40	1	2.5	TO-252, TO-251
	HLT50N15	150	50	Single	20	-	2	4	TO-220, TO-263
	HLT100N15	150	100	Single	10	-	2	4	TO-220, TO-263
200	HLT2N20	200	2	Single	520	-	1	2.5	SOT-223
	HLT4N20	200	4	Single	60	-	2	4	SOT-223, SOP-8L
	HLT25N20	200	25	Single	60	-	1	2.5	TO-252, TO-251
	HLT40N20	200	40	Single	36	-	2	4	TO-220, TO-263
	HLT75N20	200	75	Single	18	-	2	4	TO-220, TO-263

SGT MOSFET

Voltage	Part Name	V _{BRIDSS} (V)	I _b (A)	Configuration	RDS(on)-typ (mΩ) 10V	RDS(on)-typ (mΩ) 4.5V	V _{GS(th)-min} (V)	V _{GS(th)-max} (V)	Package	
-100	HLS6P100C	-100	-6	Single	75	90	-1	-2.5	SOP-8	
	HLS20P100	-100	-20	Single	75	90	-1	-2.5	TO-252, PDFN5X6-8L	
-60	HLS30P60	-60	-30	Single	40	42	-1	-3	TO-252, PDFN5X6-8L	
	HLS6P60	-60	-6.5	Single	40	42	-1	-3	SOP-8	
30	HLS30N30PF3	30	30	Single	8.5	11	1	2.5	PDFN3X3-8L	
	HLS40N30PF3	30	40	Single	6	9	1	2.5	PDFN3X3-8L	
	HLS60N30PF3	30	60	Single	3.5	5	1	2.5	PDFN3X3-8L	
	HLS120N30K	30	120	Single	3.5	4.5	1	2.5	TO-252	
	HLS150N30K	30	150	Single	2.8	3.5	1	2.5	TO-252	
	HLS180N30K	30	180	Single	2.2	3	1	2.5	TO-252	
	HLS75N30PF5	30	75	Single	3.2	4.2	1	2.5	PDFN5X6-8L	
	HLS90N30PF5	30	90	Single	2.4	3.1	1	2.5	PDFN5X6-8L	
	HLS120N30PF5	30	120	Single	1.95	2.85	1	2.5	PDFN5X6-8L	
	HLS150N30PF5	30	150	Single	1.5	2	1	2.5	PDFN5X6-8L	
	HLS170N30PF5	30	170	Single	1.1	1.45	1	2.5	PDFN5X6-8L	
	HLS190N30PF5	30	190	Single	0.97	1.25	1	2.5	PDFN5X6-8L	
	HLS210N30PF5	30	210	Single	0.72	0.85	1	2.5	PDFN5X6-8L	
	40	HLS40N40PF3	40	40	Single	6.8	10	1	2.5	PDFN3X3-8L
		HLS60N40PF3	40	60	Single	4.2	5.7	1	2.5	PDFN3X3-8L
HLS45N40K		40	45	Single	6.6	10	1	2.5	TO-252	
HLS70N40K		40	70	Single	4.8	7	1	2.5	TO-252	
HLS90N40K		40	90	Single	3.2	3.6	1	2.5	TO-252	
HLS110N40K		40	110	Single	2.35	2.8	1	2.5	TO-252	
HLS45N40PF5		40	45	Single	6.4	9.5	1	2.5	PDFN5X6-8L	
HLS85N40PF5		40	85	Single	3	4	1	2.5	PDFN5X6-8L	
HLS110N40PF5		40	110	Single	2.4	3.3	1	2.5	PDFN5X6-8L	
HLS130N40PF5		40	130	Single	1.8	2.8	1	2.5	PDFN5X6-8L	
HLS170N40PF5		40	170	Single	1.4	1.9	1	2.5	PDFN5X6-8L	
HLS200N40PF5		40	200	Single	0.85	1.1	1	2.5	PDFN5X6-8L	
HLS150N40		40	150	Single	1.75	2	2.5	4	TO-220, TO-263	
HLS170N40		40	170	Single	1.4	1.7	1	2.5	TO-220, TO-263	
HLS200N40		40	200	Single	1.1	1.3	1	2.5	TO-220, TO-263	
60	HLS11N60C	60	11	Single	11	14	1	2.5	SOP-8	
	HLS16N60C	60	16	Single	8.2	9.6	1	2.5	SOP-8	
	HLS20N60C	60	20	Single	4	4.6	1	2.5	SOP-8	
	HLS45N60K	60	45	Single	8.5	12	1	2.5	TO-252	
	HLS60N60K	60	60	Single	7.3	10	1	2.5	TO-252	
	HLS105N60K	60	105	Single	4.1	5.6	1	2.5	TO-252	
	HLS120N60K	60	120	Single	3.5	4	1	2.5	TO-252	
	HLS135N60K	60	132	Single	3.1	4.4	1	2.5	TO-252	
	HLS150N60K	60	150	Single	2.7	-	2.5	4	TO-252	
	HLS40N60PF5	60	40	Single	8.5	12	1	2.5	PDFN5X6-8L	
	HLS60N60PF5	60	60	Single	5.6	8	1	2.5	PDFN5X6-8L	
	HLS80N60PF5	60	80	Single	3.8	4.5	1	2.5	PDFN5X6-8L	
HLS90N60PF5	60	90	Single	2.8	3.5	1	2.5	PDFN5X6-8L		

Trench MOSFET

Voltage	Part Name	V _{BRIDSS} (V)	I _b (A)	Configuration	RDS(on)-typ (mΩ) 10V	RDS(on)-typ (mΩ) 4.5V	V _{GS(th)-min} (V)	V _{GS(th)-max} (V)	Package
60	HLT150N06	60	150	Single	3.2	-	2	4	TO-220, TO-263
	HLT200N06	60	200	Single	2.5	-	2	4	TO-220, TO-263
68	HLT78N07	68	78	Single	6.6	-	2	4	TO-252, TO-220, TO-251, TO-263
	HLT95N07	68	95	Single	5.8	-	2	4	TO-220, TO-263
	HLT120N07	68	120	Single	5	-	2	4	TO-220, TO-263
75	HLT140N07	68	140	Single	3.5	-	2	4	TO-220, TO-263
	HLT210N75	75	210	Single	3	-	2	4	TO-220, TO-263
80	HLT60N08	80	60	Single	11	-	2	4	TO-252, TO-220, TO-251, TO-263
	HLT70N08	80	70	Single	10	-	2	4	TO-252, TO-220, TO-251, TO-263
	HLT80N08	80	80	Single	7	7.8	1	2.5	TO-252, TO-220, TO-251, TO-263
	HLT80NH08	80	80	Single	7.5	-	2	4	TO-252, TO-220, TO-251, TO-263
	HLT140N08	80	140	Single	5	-	2	4	TO-220, TO-263
	HLT200N08	80	200	Single	3	-	2	4	TO-220, TO-263
	HLT250N08	80	250	Single	1.9	-	2	4	TO-220, TO-263
	HLT320N08	80	320	Single	1.3	-	2	4	TO-247
100	HLG123A1N	100	0.2	Single	3000	3500	1	2.5	SOT-23, SOT-323
	HLT2N10	100	2	Single	250	260	1	2.5	SOT-23
	HLT15N10	100	15	Single	94	100	1	2.5	TO-252, TO-251
	HLT17N10	100	17	Single	55	65	1	2.5	TO-252, TO-251, PDFN3333-8L
	HLT30N10	100	30	Single	24	27	1	2.5	TO-252, TO-251
	HLT8N10	100	8	Single	24	27	1	2.5	SOT-223
	HLT50N10	100	50	Single	17	-	2	4	TO-220, TO-263
	HLT20N10	100	20	Single	14	17	1	2.5	SOP-8L
	HLT60N10	100	60	Single	14	-	2	4	TO-220, TO-263
	HLT120N10	100	120	Single	7	-	2	4	TO-220, TO-263
150	HLT140N10	100	140	Single	5	-	2	4	TO-220, TO-263
	HLT180N10	100	180	Single	4	-	2	4	TO-220, TO-263
	HLT2N15	150	2	Single	260	320	1	2.5	SOT-23, SOT-223, SOP-8L
	HLT20N15	150	20	Single	65	-	2	4	TO-252, TO-251
	HLT5N15	150	5	Single	30	40	1	2.5	SOT-223, SOP-8L
	HLT40N15	150	40	Single	30	40	1	2.5	TO-252, TO-251
	HLT50N15	150	50	Single	20	-	2	4	TO-220, TO-263
	HLT100N15	150	100	Single	10	-	2	4	TO-220, TO-263
200	HLT2N20	200	2	Single	520	-	1	2.5	SOT-223
	HLT4N20	200	4	Single	60	-	2	4	SOT-223, SOP-8L
	HLT25N20	200	25	Single	60	-	1	2.5	TO-252, TO-251
	HLT40N20	200	40	Single	36	-	2	4	TO-220, TO-263
	HLT75N20	200	75	Single	18	-	2	4	TO-220, TO-263

SGT MOSFET

Voltage	Part Name	V _{BRIDSS} (V)	I _b (A)	Configuration	RDS(on)-typ (mΩ) 10V	RDS(on)-typ (mΩ) 4.5V	V _{GS(th)-min} (V)	V _{GS(th)-max} (V)	Package	
-100	HLS6P100C	-100	-6	Single	75	90	-1	-2.5	SOP-8	
	HLS20P100	-100	-20	Single	75	90	-1	-2.5	TO-252, PDFN5X6-8L	
-60	HLS30P60	-60	-30	Single	40	42	-1	-3	TO-252, PDFN5X6-8L	
	HLS6P60	-60	-6.5	Single	40	42	-1	-3	SOP-8	
30	HLS30N30PF3	30	30	Single	8.5	11	1	2.5	PDFN3X3-8L	
	HLS40N30PF3	30	40	Single	6	9	1	2.5	PDFN3X3-8L	
	HLS60N30PF3	30	60	Single	3.5	5	1	2.5	PDFN3X3-8L	
	HLS120N30K	30	120	Single	3.5	4.5	1	2.5	TO-252	
	HLS150N30K	30	150	Single	2.8	3.5	1	2.5	TO-252	
	HLS180N30K	30	180	Single	2.2	3	1	2.5	TO-252	
	HLS75N30PF5	30	75	Single	3.2	4.2	1	2.5	PDFN5X6-8L	
	HLS90N30PF5	30	90	Single	2.4	3.1	1	2.5	PDFN5X6-8L	
	HLS120N30PF5	30	120	Single	1.95	2.85	1	2.5	PDFN5X6-8L	
	HLS150N30PF5	30	150	Single	1.5	2	1	2.5	PDFN5X6-8L	
	HLS170N30PF5	30	170	Single	1.1	1.45	1	2.5	PDFN5X6-8L	
	HLS190N30PF5	30	190	Single	0.97	1.25	1	2.5	PDFN5X6-8L	
	HLS210N30PF5	30	210	Single	0.72	0.85	1	2.5	PDFN5X6-8L	
	40	HLS40N40PF3	40	40	Single	6.8	10	1	2.5	PDFN3X3-8L
		HLS60N40PF3	40	60	Single	4.2	5.7	1	2.5	PDFN3X3-8L
HLS45N40K		40	45	Single	6.6	10	1	2.5	TO-252	
HLS70N40K		40	70	Single	4.8	7	1	2.5	TO-252	
HLS90N40K		40	90	Single	3.2	3.6	1	2.5	TO-252	
HLS110N40K		40	110	Single	2.35	2.8	1	2.5	TO-252	
HLS45N40PF5		40	45	Single	6.4	9.5	1	2.5	PDFN5X6-8L	
HLS85N40PF5		40	85	Single	3	4	1	2.5	PDFN5X6-8L	
HLS110N40PF5		40	110	Single	2.4	3.3	1	2.5	PDFN5X6-8L	
HLS130N40PF5		40	130	Single	1.8	2.8	1	2.5	PDFN5X6-8L	
HLS170N40PF5		40	170	Single	1.4	1.9	1	2.5	PDFN5X6-8L	
HLS200N40PF5		40	200	Single	0.85	1.1	1	2.5	PDFN5X6-8L	
HLS150N40		40	150	Single	1.75	2	2.5	4	TO-220, TO-263	
HLS170N40		40	170	Single	1.4	1.7	1	2.5	TO-220, TO-263	
HLS200N40		40	200	Single	1.1	1.3	1	2.5	TO-220, TO-263	
60	HLS11N60C	60	11	Single	11	14	1	2.5	SOP-8	
	HLS16N60C	60	16	Single	8.2	9.6	1	2.5	SOP-8	
	HLS20N60C	60	20	Single	4	4.6	1	2.5	SOP-8	
	HLS45N60K	60	45	Single	8.5	12	1	2.5	TO-252	
	HLS60N60K	60	60	Single	7.3	10	1	2.5	TO-252	
	HLS105N60K	60	105	Single	4.1	5.6	1	2.5	TO-252	
	HLS120N60K	60	120	Single	3.5	4	1	2.5	TO-252	
	HLS135N60K	60	132	Single	3.1	4.4	1	2.5	TO-252	
	HLS150N60K	60	150	Single	2.7	-	2.5	4	TO-252	
	HLS40N60PF5	60	40	Single	8.5	12	1	2.5	PDFN5X6-8L	
	HLS60N60PF5	60	60	Single	5.6	8	1	2.5	PDFN5X6-8L	
	HLS80N60PF5	60	80	Single	3.8	4.5	1	2.5	PDFN5X6-8L	
HLS90N60PF5	60	90	Single	2.8	3.5	1	2.5	PDFN5X6-8L		

SGT MOSFET

Voltage	Part Name	V _{BR(DSS)} (V)	I _b (A)	Configuration	RDS(on)-typ (mΩ) 10V	RDS(on)-typ (mΩ) 4.5V	V _{(GS)th-min} (V)	V _{(GS)th-max} (V)	Package
60	HLS150N60PF5	60	150	Single	2.1	2.8	1	2.5	PDFN5X6-8L
	HLS180N60PF5	60	180	Single	1.7	2.3	1	2.5	PDFN5X6-8L
	HLS220N60PF5	60	220	Single	1.4	1.9	1	2.5	PDFN5X6-8L
	HLS105N60	60	105	Single	3.9	5.3	1	2.5	TO-220, TO-263
	HLS140N60	60	140	Single	2.9	4.1	1	2.5	TO-220, TO-263
	HLS180N60	60	180	Single	2.5	-	2.5	4	TO-220, TO-263
	HLS190N60	60	190	Single	2.2	-	2.5	4	TO-220, TO-263
	HLS200N60	60	200	Single	1.8	-	2.5	4	TO-220, TO-263
	HLS230N60	60	230	Single	1.5	-	2.5	4	TO-220, TO-263
	HLS200NH60Q	60	200	Single	2	-	2.5	4	TO-247
80	HLS230NH60Q	60	230	Single	1.7	-	2.5	4	TO-247
	HLS14N80C	80	14	Single	6.4	8.6	1	2.5	SOP-8
	HLS17N80C	80	17	Single	4.6	6.2	1	2.5	SOP-8
	HLS85N80K	80	85	Single	6.5	9	1	2.5	TO-252
	HLS110N80K	80	110	Single	4.6	6.2	1	2.5	TO-252
	HLS85N80PF5	80	85	Single	6.3	8.7	1	2.5	PDFN5X6-8L
	HLS100N80PF5	80	100	Single	4.3	5.9	1	2.5	PDFN5X6-8L
	HLS132NH80PF5	80	132	Single	3	-	2.5	4	PDFN5X6-8L
	HLS132N80PF5	80	132	Single	3	3.7	1	2.5	PDFN5X6-8L
	HLS145NH80PF5	80	145	Single	2.4	-	2.5	4	PDFN5X6-8L
100	HLS145N80PF5	80	145	Single	2.4	3.4	1	2.5	PDFN5X6-8L
	HLS85N80	80	85	Single	6	8.4	1	2.5	TO-220, TO-263
	HLS130N85	85	130	Single	4.3	-	2.5	4	TO-220, TO-263
	HLS135N85	85	135	Single	4.1	-	2.5	4	TO-220, TO-263
	HLS187N80	80	187	Single	2.9	-	2.5	4	TO-220, TO-263
	HLS250N80	80	250	Single	1.8	-	2.5	4	TO-220, TO-263
	HLS187N80Q	80	187	Single	3.1	-	2.5	4	TO-247
	HLS250N80Q	80	250	Single	2.1	-	2.5	4	TO-247
	HLS7N100C	100	7.4	Single	22	26	1	2.5	SOP-8
	HLS12N100C	100	12	Single	9.9	11.5	1	2.5	SOP-8
100	HLS16N100C	100	16	Single	7.9	9.1	1	2.5	SOP-8
	HLS35N100K	100	35	Single	18	22	1	2.5	TO-252
	HLS45N100K	100	45	Single	15.5	20	1	2.5	TO-252
	HLS72N100K	100	72	Single	9	11	1	2.5	TO-252
	HLS90N100K	100	90	Single	7.5	9.5	1	2.5	TO-252
	HLS105N100K	100	105	Single	6.4	7.8	1	2.5	TO-252
	HLS30N100PF5	100	30	Single	21	25	1	2.5	PDFN5X6-8L
	HLS40N100PF5	100	40	Single	15.5	20	1	2.5	PDFN5X6-8L
	HLS55N100PF5	100	55	Single	9.5	11.5	1	2.5	PDFN5X6-8L
	HLS55NH100PF5	100	55	Single	9	12	2.5	4	PDFN5X6-8L
100	HLS72N100PF5	100	75	Single	7.2	-	2.5	4	PDFN5X6-8L
	HLS112N100PF5	100	112	Single	4.6	5.6	1	2.5	PDFN5X6-8L
	HLS128NH100PF5	100	128	Single	3.7	-	2.5	4	PDFN5X6-8L
	HLS47N100	100	47	Single	18	23	1	2.5	TO-220, TO-263
	HLS72N100	100	72	Single	12	-	2.5	4	TO-220, TO-263

SGT MOSFET

Voltage	Part Name	V _{BR(DSS)} (V)	I _b (A)	Configuration	RDS(on)-typ (mΩ) 10V	RDS(on)-typ (mΩ) 4.5V	V _{(GS)th-min} (V)	V _{(GS)th-max} (V)	Package
100	HLS100N100	100	100	Single	7.5	-	2.5	4	TO-220, TO-263
	HLS120N100	100	120	Single	6.2	-	2.5	4	TO-220, TO-263
	HLS135N100	100	135	Single	4.6	-	2.5	4	TO-220, TO-263
	HLS155N100	100	155	Single	3.9	-	2.5	4	TO-220, TO-263
	HLS170N100	100	172	Single	3.4	-	2.5	4	TO-220, TO-263
	HLS190N100	100	190	Single	2.8	-	2.5	4	TO-220, TO-263
	HLS190N100Q	100	190	Single	3	-	2.5	4	TO-247
	HLS250N100Q	100	250	Single	2.2	-	2.5	4	TO-247
	HLS300N100Q	100	300	Single	1.8	-	2.5	4	TO-247
	120	HLS50N120PF5	120	50	Single	10	12	1	2.5
HLS83N120PF5		120	83	Single	7.8	8.6	1	2.5	PDFN5X6-8L
HLS99N120PF5		120	99	Single	5.8	7.5	1	2.5	PDFN5X6-8L
HLS50N120K		120	50	Single	8.8	10.7	1	2.5	TO-252
HLS110N120K		120	110	Single	7.8	8.6	1	2.5	TO-252
HLS50N120		120	50	Single	8.8	10.7	1	2.5	TO-220, TO-263
HLS100N120		120	100	Single	5.8	7.5	1	2.5	TO-220, TO-263
HLS160N120		120	160	Single	4.4	5	1	2.5	TO-220, TO-263
HLS200N120		120	200	Single	3.6	-	2.5	4	TO-220, TO-263
HLS247N120		120	247	Single	3	-	2.5	4	TO-220, TO-263
150	HLS197N120Q	120	197	Single	3.8	-	2.5	4	TO-247
	HLS247N120Q	120	247	Single	3.2	-	2.5	4	TO-247
	HLS50N150PF5	150	50	Single	21	-	2.5	4	PDFN5X6-8L
	HLS60N150PF5	150	60	Single	15	-	2.5	4	PDFN5X6-8L
	HLS80N150PF5	150	80	Single	8	9.4	1	2.5	PDFN5X6-8L
	HLS20N150K	150	20	Single	56	68	1	2.5	TO-252
	HLS30N150K	150	30	Single	41	-	2.5	4	TO-252
	HLS45N150K	150	45	Single	24	-	2.5	4	TO-252
	HLS70N150K	150	70	Single	16	19	1	2.5	TO-252
	HLS80N150	150	80	Single	13.7	-	2.5	4	TO-220, TO-263
200	HLS110N150	150	110	Single	10.8	-	2.5	4	TO-220, TO-263
	HLS122N150	150	122	Single	8.2	-	1	2.5	TO-220, TO-263
	HLS164N150	150	164	Single	5.9	-	2.5	4	TO-220, TO-263
	HLS110N150Q	150	110	Single	11	-	2.5	4	TO-247
	HLS122N150Q	150	122	Single	8.4	-	1	2.5	TO-247
	HLS164N150Q	150	164	Single	6.1	-	2.5	4	TO-247
	HLS18N200K	200	18	Single	95	106	1	2.5	TO-252
	HLS100N200	200	100	Single	10.4	-	2.5	4	TO-220, TO-263
	HLS132N200	200	132	Single	8.6	-	2.5	4	TO-220, TO-263
	HLS100N200Q	200	100	Single	10.5	-	2.5	4	TO-247
250	HLS132N200Q	200	132	Single	8.8	-	2.5	4	TO-247
	HLS13N250	250	13	Single	180	190	1	2.5	TO-220, TO-263
	HLS25N250	250	25	Single	87	93	1	2.5	TO-220, TO-263
	HLS93N250	250	93	Single	16.3	-	2.5	4	TO-220, TO-263
HLS93N250Q	250	93	Single	15.5	-	2.5	4	TO-247	

SGT MOSFET

Voltage	Part Name	V _{BR(DSS)} (V)	I _b (A)	Configuration	RDS(on)-typ (mΩ) 10V	RDS(on)-typ (mΩ) 4.5V	V _{(GS)th-min} (V)	V _{(GS)th-max} (V)	Package
60	HLS150N60PF5	60	150	Single	2.1	2.8	1	2.5	PDFN5X6-8L
	HLS180N60PF5	60	180	Single	1.7	2.3	1	2.5	PDFN5X6-8L
	HLS220N60PF5	60	220	Single	1.4	1.9	1	2.5	PDFN5X6-8L
	HLS105N60	60	105	Single	3.9	5.3	1	2.5	TO-220, TO-263
	HLS140N60	60	140	Single	2.9	4.1	1	2.5	TO-220, TO-263
	HLS180N60	60	180	Single	2.5	-	2.5	4	TO-220, TO-263
	HLS190N60	60	190	Single	2.2	-	2.5	4	TO-220, TO-263
	HLS200N60	60	200	Single	1.8	-	2.5	4	TO-220, TO-263
	HLS230N60	60	230	Single	1.5	-	2.5	4	TO-220, TO-263
	HLS200NH60Q	60	200	Single	2	-	2.5	4	TO-247
80	HLS230NH60Q	60	230	Single	1.7	-	2.5	4	TO-247
	HLS14N80C	80	14	Single	6.4	8.6	1	2.5	SOP-8
	HLS17N80C	80	17	Single	4.6	6.2	1	2.5	SOP-8
	HLS85N80K	80	85	Single	6.5	9	1	2.5	TO-252
	HLS110N80K	80	110	Single	4.6	6.2	1	2.5	TO-252
	HLS85N80PF5	80	85	Single	6.3	8.7	1	2.5	PDFN5X6-8L
	HLS100N80PF5	80	100	Single	4.3	5.9	1	2.5	PDFN5X6-8L
	HLS132NH80PF5	80	132	Single	3	-	2.5	4	PDFN5X6-8L
	HLS132N80PF5	80	132	Single	3	3.7	1	2.5	PDFN5X6-8L
	HLS145NH80PF5	80	145	Single	2.4	-	2.5	4	PDFN5X6-8L
100	HLS145N80PF5	80	145	Single	2.4	3.4	1	2.5	PDFN5X6-8L
	HLS85N80	80	85	Single	6	8.4	1	2.5	TO-220, TO-263
	HLS130N85	85	130	Single	4.3	-	2.5	4	TO-220, TO-263
	HLS135N85	85	135	Single	4.1	-	2.5	4	TO-220, TO-263
	HLS187N80	80	187	Single	2.9	-	2.5	4	TO-220, TO-263
	HLS250N80	80	250	Single	1.8	-	2.5	4	TO-220, TO-263
	HLS187N80Q	80	187	Single	3.1	-	2.5	4	TO-247
	HLS250N80Q	80	250	Single	2.1	-	2.5	4	TO-247
	HLS7N100C	100	7.4	Single	22	26	1	2.5	SOP-8
	HLS12N100C	100	12	Single	9.9	11.5	1	2.5	SOP-8
100	HLS16N100C	100	16	Single	7.9	9.1	1	2.5	SOP-8
	HLS35N100K	100	35	Single	18	22	1	2.5	TO-252
	HLS45N100K	100	45	Single	15.5	20	1	2.5	TO-252
	HLS72N100K	100	72	Single	9	11	1	2.5	TO-252
	HLS90N100K	100	90	Single	7.5	9.5	1	2.5	TO-252
	HLS105N100K	100	105	Single	6.4	7.8	1	2.5	TO-252
	HLS30N100PF5	100	30	Single	21	25	1	2.5	PDFN5X6-8L
	HLS40N100PF5	100	40	Single	15.5	20	1	2.5	PDFN5X6-8L
	HLS55N100PF5	100	55	Single	9.5	11.5	1	2.5	PDFN5X6-8L
	HLS55NH100PF5	100	55	Single	9	12	2.5	4	PDFN5X6-8L
100	HLS72N100PF5	100	75	Single	7.2	-	2.5	4	PDFN5X6-8L
	HLS112N100PF5	100	112	Single	4.6	5.6	1	2.5	PDFN5X6-8L
	HLS128NH100PF5	100	128	Single	3.7	-	2.5	4	PDFN5X6-8L
	HLS47N100	100	47	Single	18	23	1	2.5	TO-220, TO-263
	HLS72N100	100	72	Single	12	-	2.5	4	TO-220, TO-263

SGT MOSFET

Voltage	Part Name	V _{BR(DSS)} (V)	I _b (A)	Configuration	RDS(on)-typ (mΩ) 10V	RDS(on)-typ (mΩ) 4.5V	V _{(GS)th-min} (V)	V _{(GS)th-max} (V)	Package
100	HLS100N100	100	100	Single	7.5	-	2.5	4	TO-220, TO-263
	HLS120N100	100	120	Single	6.2	-	2.5	4	TO-220, TO-263
	HLS135N100	100	135	Single	4.6	-	2.5	4	TO-220, TO-263
	HLS155N100	100	155	Single	3.9	-	2.5	4	TO-220, TO-263
	HLS170N100	100	172	Single	3.4	-	2.5	4	TO-220, TO-263
	HLS190N100	100	190	Single	2.8	-	2.5	4	TO-220, TO-263
	HLS190N100Q	100	190	Single	3	-	2.5	4	TO-247
	HLS250N100Q	100	250	Single	2.2	-	2.5	4	TO-247
	HLS300N100Q	100	300	Single	1.8	-	2.5	4	TO-247
	120	HLS50N120PF5	120	50	Single	10	12	1	2.5
HLS83N120PF5		120	83	Single	7.8	8.6	1	2.5	PDFN5X6-8L
HLS99N120PF5		120	99	Single	5.8	7.5	1	2.5	PDFN5X6-8L
HLS50N120K		120	50	Single	8.8	10.7	1	2.5	TO-252
HLS110N120K		120	110	Single	7.8	8.6	1	2.5	TO-252
HLS50N120		120	50	Single	8.8	10.7	1	2.5	TO-220, TO-263
HLS100N120		120	100	Single	5.8	7.5	1	2.5	TO-220, TO-263
HLS160N120		120	160	Single	4.4	5	1	2.5	TO-220, TO-263
HLS200N120		120	200	Single	3.6	-	2.5	4	TO-220, TO-263
HLS247N120		120	247	Single	3	-	2.5	4	TO-220, TO-263
150	HLS197N120Q	120	197	Single	3.8	-	2.5	4	TO-247
	HLS247N120Q	120	247	Single	3.2	-	2.5	4	TO-247
	HLS50N150PF5	150	50	Single	21	-	2.5	4	PDFN5X6-8L
	HLS60N150PF5	150	60	Single	15	-	2.5	4	PDFN5X6-8L
	HLS80N150PF5	150	80	Single	8	9.4	1	2.5	PDFN5X6-8L
	HLS20N150K	150	20	Single	56	68	1	2.5	TO-252
	HLS30N150K	150	30	Single	41	-	2.5	4	TO-252
	HLS45N150K	150	45	Single	24	-	2.5	4	TO-252
	HLS70N150K	150	70	Single	16	19	1	2.5	TO-252
	HLS80N150	150	80	Single	13.7	-	2.5	4	TO-220, TO-263
200	HLS110N150	150	110	Single	10.8	-	2.5	4	TO-220, TO-263
	HLS122N150	150	122	Single	8.2	-	1	2.5	TO-220, TO-263
	HLS164N150	150	164	Single	5.9	-	2.5	4	TO-220, TO-263
	HLS110N150Q	150	110	Single	11	-	2.5	4	TO-247
	HLS122N150Q	150	122	Single	8.4	-	1	2.5	TO-247
	HLS164N150Q	150	164	Single	6.1	-	2.5	4	TO-247
	HLS18N200K	200	18	Single	95	106	1	2.5	TO-252
	HLS100N200	200	100	Single	10.4	-	2.5	4	TO-220, TO-263
	HLS132N200	200	132	Single	8.6	-	2.5	4	TO-220, TO-263
	HLS100N200Q	200	100	Single	10.5	-	2.5	4	TO-247
250	HLS132N200Q	200	132	Single	8.8	-	2.5	4	TO-247
	HLS13N250	250	13	Single	180	190	1	2.5	TO-220, TO-263
	HLS25N250	250	25	Single	87	93	1	2.5	TO-220, TO-263
	HLS93N250	250	93	Single	16.3	-	2.5	4	TO-220, TO-263
HLS93N250Q	250	93	Single	15.5	-	2.5	4	TO-247	

VDMOS

Voltage	Part Name	V _{(BR)DSS} (V)	I _b (A)	Configuration	R _{DS(on)-typ} 10V(Ω)	R _{DS(on)-max} 10V(Ω)	V _{(GS)th-min} (V)	V _{(GS)th-max} (V)	Package	
650	HLP20N65	650	20	Single	0.42	0.5	2	4	TO-263,TO-220,TO-220F	
	HLP25N65	650	25	Single	0.25	0.3	2	4	TO-247,TO-3P	
	HLP35N65	650	35	Single	0.14	0.17	2	4	TO-247,TO-3P	
	HLP1N70	700	1.2	Single	9.3	13.5	2	4	TO-92,TO-251,TO-252,TO-220F	
700	HLP2N70	700	2	Single	4.1	4.8	2	4	TO-252,TO-251,TO-220F	
	HLP3N70	700	3	Single	3.5	4.1	2	4	TO-252,TO-251,TO-220F	
	HLP4N70	700	4	Single	2.6	3	2	4	TO-252,TO-251,TO-220F	
	HLP5N70	700	5	Single	1.9	2.4	2	4	TO-252,TO-251,TO-220F	
	HLP6N70	700	6	Single	1.3	1.6	2	4	TO-252,TO-251,TO-220F	
	HLP7N70	700	7	Single	1.15	1.4	2	4	TO-252,TO-251,TO-220F	
	HLP8N70	700	8	Single	0.95	1.1	2	4	TO-263,TO-220,TO-220F	
	HLP9N70	700	9	Single	0.83	1	2	4	TO-263,TO-220,TO-220F	
	HLP11N70	700	11	Single	0.7	0.85	2	4	TO-263,TO-220,TO-220F	
	HLP13N70	700	13	Single	0.65	0.8	2	4	TO-263,TO-220,TO-220F	
	HLP15N70	700	15	Single	0.56	0.66	2	4	TO-263,TO-220,TO-220F	
	HLP18N70	700	18	Single	0.45	0.55	2	4	TO-263,TO-220,TO-220F	
	800	HLP3N80	800	3	Single	4	4.8	2	4	TO-263,TO-220,TO-220F,TO-252,TO-251
		HLP4N80	800	4	Single	3.2	3.8	2	4	TO-263,TO-220,TO-220F,TO-252,TO-251
		HLP5N80	800	5	Single	2.3	2.8	2	4	TO-263,TO-220,TO-220F,TO-252,TO-251
		HLP7N80	800	7	Single	1.35	1.6	2	4	TO-263,TO-220,TO-220F,TO-252,TO-251
HLP9N80		800	9	Single	1	1.2	2	4	TO-263,TO-220,TO-220F	
HLP10N80		800	10	Single	0.74	1	2	4	TO-263,TO-220,TO-220F	
HLP12N80		800	12	Single	0.66	0.8	2	4	TO-263,TO-220,TO-220F	
HLP14N80		800	14	Single	0.6	0.72	2	4	TO-263,TO-220,TO-220F	
900		HLP2N90	900	2	Single	5	6	2	4	TO-252,TO-251,TO-220F,TO-220
		HLP3N90	900	3	Single	4	4.8	2	4	TO-252,TO-251,TO-220F,TO-220
	HLP4N90	900	4	Single	3	3.5	2	4	TO-252,TO-251,TO-220F,TO-220	
	HLP6N90	900	6	Single	1.7	2	2	4	TO-263,TO-220,TO-220F	
	HLP9N90	900	9	Single	0.95	1.3	2	4	TO-263,TO-220,TO-220F,TO-3P,TO-247	
	HLP11N90	900	11	Single	0.75	1	2	4	TO-3P,TO-247	
	HLP16N90	900	16	Single	0.58	0.78	2	4	TO-3P,TO-247	
	HLP20N90	900	20	Single	0.28	0.4	2	4	TO-3P,TO-247	
1000	HLP2N100	1000	2	Single	6	7.2	2	4	TO-252,TO-251,TO-220F	
	HLP3N100	1000	3	Single	4.6	5.5	2	4	TO-263,TO-220,TO-220F	
	HLP4N100	1000	4	Single	3.6	4.3	2	4	TO-263,TO-220,TO-220F,TO-3P,TO-247	
	HLP5N100	1000	5	Single	2.1	2.5	2	4	TO-3P,TO-247	
	HLP6N100	1000	6	Single	1.2	1.5	2	4	TO-3P,TO-247	
	1200	HLP2N120	1200	2	Single	7.5	9	2	4	TO-263,TO-220,TO-220F
HLP3N120		1200	3	Single			2	4	TO-263,TO-220,TO-220F	
HLP4N120		1200	4	Single			2	4	TO-3P,TO-247	
HLP5N120		1200	5	Single	2.8	3.4	2	4	TO-3P,TO-247	
HLP6N120		1200	6	Single	1.9	2.2	2	4	TO-3P,TO-247	
HLP8N120		1200	8	Single	1.3	1.6	2	4	TO-3P,TO-247	
1500	HLP3N150	1500	3	Single	6	7.2	2	4	TO-3P,TO-247	
	HLP4N150	1500	4	Single	4.5	6	2	4	TO-3P,TO-247	

SJ MOSFET

Voltage	Part Name	V _{(BR)DSS} (V)	I _b (A)	Configuration	R _{DS(on)-typ} 10V(Ω)	R _{DS(on)-max} 10V(Ω)	V _{(GS)th-min} (V)	V _{(GS)th-max} (V)	Package	
500	HLS50R5K4	500	1	Single	4.9	5.4	2.5	4	TO-251, TO-252	
	HLS50R1K5	500	2	Single	1.3	1.5	2.5	4	TO-251, TO-252	
	HLS50R690	500	4	Single	0.63	0.69	2.5	4	TO-251, TO-252, TO-220, TO-263, TO-220F	
	HLS50R500	500	6	Single	0.45	0.5	2.5	4	TO-251, TO-252, TO-220, TO-263, TO-220F	
	HLS50R400	500	7	Single	0.36	0.4	2.5	4	TO-251, TO-252, TO-220, TO-263, TO-220F	
	HLS50R250	500	11	Single	0.25	0.28	2.5	4	TO-220, TO-263, TO-220F	
	HLS50R120	500	20	Single	0.1	0.12	2.5	4	TO-220, TO-263, TO-220F, TO-3P, TO-247	
	HLS50R060	500	47	Single	0.05	0.06	2.5	4	TO-3P, TO-247	
	600	HLS60R7K5	600	1	Single	6.5	7.5	2.5	4	TO-251, TO-252
		HLS60R1K7	600	2	Single	1.5	1.7	2.5	4	TO-251, TO-252
HLS60R840		600	4	Single	0.84	0.9	2.5	4	TO-251, TO-252, TO-220, TO-263, TO-220F	
HLS60R700		600	6	Single	0.63	0.7	2.5	4	TO-251, TO-252, TO-220, TO-263, TO-220F	
HLS60R580		600	7	Single	0.5	0.58	2.5	4	TO-251, TO-252, TO-220, TO-263, TO-220F	
HLS60R330		600	11	Single	0.29	0.33	2.5	4.5	TO-251, TO-252, TO-220, TO-263, TO-220F	
HLS60R240		600	15	Single	0.21	0.24	2.5	4.5	TO-220, TO-263, TO-220F	
HLS60R180		600	20	Single	0.16	0.18	2.5	4	TO-220, TO-263, TO-220F	
HLS60R075		600	47	Single	0.068	0.075	2.5	4	TO-3P, TO-247	
HLS60R060		600	53	Single	0.06	0.07	2.5	4	TO-3P, TO-247	
650	HLS65R9K2	650	1	Single	8.4	9.2	2.5	4	TO-251, TO-252	
	HLS65R2K2	650	2	Single	2	2.2	2.5	4	TO-251, TO-252	
	HLS65R940	650	4	Single	0.88	1	2.5	4	TO-251, TO-252, TO-220, TO-263, TO-220F	
	HLS65R750	650	6	Single	0.7	0.8	2.5	4	TO-251, TO-252, TO-220, TO-263, TO-220F	
	HLS65R600	650	7	Single	0.54	0.6	2.5	4	TO-251, TO-252, TO-220, TO-263, TO-220F	
	HLS65R420	650	10	Single	0.38	0.42	2.5	4	TO-220, TO-263, TO-220F	
	HLS65R380	650	11	Single	0.34	0.38	2.5	4	TO-220, TO-263, TO-220F	
	HLS65R260	650	15	Single	0.23	0.26	2.5	4.5	TO-220, TO-263, TO-220F	
	HLS65R160	650	20	Single	0.14	0.16	2.5	4	TO-220, TO-263, TO-220F	
	HLS65R080	650	47	Single	0.072	0.08	2.5	4	TO-3P, TO-247	
700	HLS70R040	650	72	Single	0.035	0.04	2.5	4.5	TO-3P, TO-247	
	HLS70R2K8	700	2	Single	2.5	2.8	2.5	4	TO-251, TO-252	
	HLS70R1K5	700	3	Single	1.3	1.5	2.5	4	TO-251, TO-252	
	HLS70R1K4	700	4	Single	1.26	1.4	2.5	4	TO-251, TO-252, TO-220, TO-263, TO-220F	
	HLS70R950	700	6	Single	0.86	1	2.5	4	TO-251, TO-252, TO-220, TO-263, TO-220F	
	HLS70R600	700	7	Single	0.53	0.6	2.5	4.5	TO-251, TO-252, TO-220, TO-263, TO-220F	
	HLS70R450	700	11	Single	0.38	0.45	2.5	4.5	TO-220, TO-263, TO-220F	
	HLS70R360	700	11	Single	0.32	0.36	2.5	4.5	TO-220, TO-263, TO-220F	
	HLS70R170	700	20	Single	0.15	0.17	2.5	4.5	TO-220, TO-263, TO-220F	
	HLS70R190	700	20	Single	0.17	0.19	2.5	4.5	TO-220, TO-263, TO-220F	
800	HLS70R110	700	47	Single	0.1	0.11	2.5	4	TO-3P, TO-247	
	HLS80R1K5	800	4	Single	1.3	1.5	2.5	4	TO-251, TO-252	
	HLS80R1K1	800	6	Single	0.95	1.1	2.5	4	TO-251, TO-252, TO-220, TO-263, TO-220F	
	HLS80R300	800	15	Single	0.26	0.3	2.5	4.5	TO-220, TO-263, TO-220F	
	HLS80R250	800	18	Single	0.24	0.28	2.5	4.5	TO-220, TO-263, TO-220F	
	900	HLS90R350	900	15	Single	0.3	0.35	2.5	4.5	TO-220, TO-263, TO-220F
		HLS100R500	1000	12	Single	0.4	0.5	2.5	4.5	TO-220, TO-263, TO-220F
	1100	HLS110R550	1100	12	Single	0.41	0.5	2.5	4.5	TO-220, TO-263, TO-220F
	1200	HLS120R800	1200	12	Single	0.62	0.8	2.5	4.5	TO-220, TO-263, TO-220F

VDMOS

Voltage	Part Name	V _{(BR)DSS} (V)	I _b (A)	Configuration	R _{DS(on)-typ} 10V(Ω)	R _{DS(on)-max} 10V(Ω)	V _{(GS)th-min} (V)	V _{(GS)th-max} (V)	Package	
650	HLP20N65	650	20	Single	0.42	0.5	2	4	TO-263,TO-220,TO-220F	
	HLP25N65	650	25	Single	0.25	0.3	2	4	TO-247,TO-3P	
	HLP35N65	650	35	Single	0.14	0.17	2	4	TO-247,TO-3P	
700	HLP1N70	700	1.2	Single	9.3	13.5	2	4	TO-92,TO-251,TO-252,TO-220F	
	HLP2N70	700	2	Single	4.1	4.8	2	4	TO-252,TO-251,TO-220F	
	HLP3N70	700	3	Single	3.5	4.1	2	4	TO-252,TO-251,TO-220F	
	HLP4N70	700	4	Single	2.6	3	2	4	TO-252,TO-251,TO-220F	
	HLP5N70	700	5	Single	1.9	2.4	2	4	TO-252,TO-251,TO-220F	
	HLP6N70	700	6	Single	1.3	1.6	2	4	TO-252,TO-251,TO-220F	
	HLP7N70	700	7	Single	1.15	1.4	2	4	TO-252,TO-251,TO-220F	
	HLP8N70	700	8	Single	0.95	1.1	2	4	TO-263,TO-220,TO-220F	
	HLP9N70	700	9	Single	0.83	1	2	4	TO-263,TO-220,TO-220F	
	HLP11N70	700	11	Single	0.7	0.85	2	4	TO-263,TO-220,TO-220F	
	HLP13N70	700	13	Single	0.65	0.8	2	4	TO-263,TO-220,TO-220F	
	HLP15N70	700	15	Single	0.56	0.66	2	4	TO-263,TO-220,TO-220F	
800	HLP18N70	700	18	Single	0.45	0.55	2	4	TO-263,TO-220,TO-220F	
	HLP3N80	800	3	Single	4	4.8	2	4	TO-263,TO-220,TO-220F,TO-252,TO-251	
	HLP4N80	800	4	Single	3.2	3.8	2	4	TO-263,TO-220,TO-220F,TO-252,TO-251	
	HLP5N80	800	5	Single	2.3	2.8	2	4	TO-263,TO-220,TO-220F,TO-252,TO-251	
	HLP7N80	800	7	Single	1.35	1.6	2	4	TO-263,TO-220,TO-220F,TO-252,TO-251	
	HLP9N80	800	9	Single	1	1.2	2	4	TO-263,TO-220,TO-220F	
	HLP10N80	800	10	Single	0.74	1	2	4	TO-263,TO-220,TO-220F	
	HLP12N80	800	12	Single	0.66	0.8	2	4	TO-263,TO-220,TO-220F	
	HLP14N80	800	14	Single	0.6	0.72	2	4	TO-263,TO-220,TO-220F	
	HLP2N90	900	2	Single	5	6	2	4	TO-252,TO-251,TO-220F,TO-220	
900	HLP3N90	900	3	Single	4	4.8	2	4	TO-252,TO-251,TO-220F,TO-220	
	HLP4N90	900	4	Single	3	3.5	2	4	TO-252,TO-251,TO-220F,TO-220	
	HLP6N90	900	6	Single	1.7	2	2	4	TO-263,TO-220,TO-220F	
	HLP9N90	900	9	Single	0.95	1.3	2	4	TO-263,TO-220,TO-220F,TO-3P,TO-247	
	HLP11N90	900	11	Single	0.75	1	2	4	TO-3P,TO-247	
	HLP16N90	900	16	Single	0.58	0.78	2	4	TO-3P,TO-247	
	HLP20N90	900	20	Single	0.28	0.4	2	4	TO-3P,TO-247	
	1000	HLP2N100	1000	2	Single	6	7.2	2	4	TO-252,TO-251,TO-220F
		HLP3N100	1000	3	Single	4.6	5.5	2	4	TO-263,TO-220,TO-220F
		HLP4N100	1000	4	Single	3.6	4.3	2	4	TO-263,TO-220,TO-220F,TO-3P,TO-247
HLP5N100		1000	5	Single	2.1	2.5	2	4	TO-3P,TO-247	
HLP6N100		1000	6	Single	1.2	1.5	2	4	TO-3P,TO-247	
HLP2N120		1200	2	Single	7.5	9	2	4	TO-263,TO-220,TO-220F	
1200	HLP3N120	1200	3	Single			2	4	TO-263,TO-220,TO-220F	
	HLP4N120	1200	4	Single			2	4	TO-3P,TO-247	
	HLP5N120	1200	5	Single	2.8	3.4	2	4	TO-3P,TO-247	
	HLP6N120	1200	6	Single	1.9	2.2	2	4	TO-3P,TO-247	
1500	HLP8N120	1200	8	Single	1.3	1.6	2	4	TO-3P,TO-247	
	HLP3N150	1500	3	Single	6	7.2	2	4	TO-3P,TO-247	
	HLP4N150	1500	4	Single	4.5	6	2	4	TO-3P,TO-247	

SJ MOSFET

Voltage	Part Name	V _{(BR)DSS} (V)	I _b (A)	Configuration	R _{DS(on)-typ} 10V(Ω)	R _{DS(on)-max} 10V(Ω)	V _{(GS)th-min} (V)	V _{(GS)th-max} (V)	Package	
500	HLS50R5K4	500	1	Single	4.9	5.4	2.5	4	TO-251, TO-252	
	HLS50R1K5	500	2	Single	1.3	1.5	2.5	4	TO-251, TO-252	
	HLS50R690	500	4	Single	0.63	0.69	2.5	4	TO-251, TO-252, TO-220, TO-263, TO-220F	
	HLS50R500	500	6	Single	0.45	0.5	2.5	4	TO-251, TO-252, TO-220, TO-263, TO-220F	
	HLS50R400	500	7	Single	0.36	0.4	2.5	4	TO-251, TO-252, TO-220, TO-263, TO-220F	
	HLS50R250	500	11	Single	0.25	0.28	2.5	4	TO-220, TO-263, TO-220F	
	HLS50R120	500	20	Single	0.1	0.12	2.5	4	TO-220, TO-263, TO-220F, TO-3P, TO-247	
	HLS50R060	500	47	Single	0.05	0.06	2.5	4	TO-3P, TO-247	
	600	HLS60R7K5	600	1	Single	6.5	7.5	2.5	4	TO-251, TO-252
		HLS60R1K7	600	2	Single	1.5	1.7	2.5	4	TO-251, TO-252
		HLS60R840	600	4	Single	0.84	0.9	2.5	4	TO-251, TO-252, TO-220, TO-263, TO-220F
		HLS60R700	600	6	Single	0.63	0.7	2.5	4	TO-251, TO-252, TO-220, TO-263, TO-220F
HLS60R580		600	7	Single	0.5	0.58	2.5	4	TO-251, TO-252, TO-220, TO-263, TO-220F	
HLS60R330		600	11	Single	0.29	0.33	2.5	4.5	TO-251, TO-252, TO-220, TO-263, TO-220F	
HLS60R240		600	15	Single	0.21	0.24	2.5	4.5	TO-220, TO-263, TO-220F	
HLS60R180		600	20	Single	0.16	0.18	2.5	4	TO-220, TO-263, TO-220F	
HLS60R075		600	47	Single	0.068	0.075	2.5	4	TO-3P, TO-247	
HLS60R060		600	53	Single	0.06	0.07	2.5	4	TO-3P, TO-247	
650		HLS65R9K2	650	1	Single	8.4	9.2	2.5	4	TO-251, TO-252
		HLS65R2K2	650	2	Single	2	2.2	2.5	4	TO-251, TO-252
	HLS65R940	650	4	Single	0.88	1	2.5	4	TO-251, TO-252, TO-220, TO-263, TO-220F	
	HLS65R750	650	6	Single	0.7	0.8	2.5	4	TO-251, TO-252, TO-220, TO-263, TO-220F	
	HLS65R600	650	7	Single	0.54	0.6	2.5	4	TO-251, TO-252, TO-220, TO-263, TO-220F	
	HLS65R420	650	10	Single	0.38	0.42	2.5	4	TO-220, TO-263, TO-220F	
	HLS65R380	650	11	Single	0.34	0.38	2.5	4	TO-220, TO-263, TO-220F	
	HLS65R260	650	15	Single	0.23	0.26	2.5	4.5	TO-220, TO-263, TO-220F	
	HLS65R160	650	20	Single	0.14	0.16	2.5	4	TO-220, TO-263, TO-220F	
	HLS65R080	650	47	Single	0.072	0.08	2.5	4	TO-3P, TO-247	
	700	HLS65R040	650	72	Single	0.035	0.04	2.5	4.5	TO-3P, TO-247
		HLS70R2K8	700	2	Single	2.5	2.8	2.5	4	TO-251, TO-252
HLS70R1K5		700	3	Single	1.3	1.5	2.5	4	TO-251, TO-252	
HLS70R1K4		700	4	Single	1.26	1.4	2.5	4	TO-251, TO-252, TO-220, TO-263, TO-220F	
HLS70R950		700	6	Single	0.86	1	2.5	4	TO-251, TO-252, TO-220, TO-263, TO-220F	
HLS70R600		700	7	Single	0.53	0.6	2.5	4.5	TO-251, TO-252, TO-220, TO-263, TO-220F	
HLS70R450		700	11	Single	0.38	0.45	2.5	4.5	TO-220, TO-263, TO-220F	
HLS70R360		700	11	Single	0.32	0.36	2.5	4.5	TO-220, TO-263, TO-220F	
HLS70R170		700	20	Single	0.15	0.17	2.5	4.5	TO-220, TO-263, TO-220F	
HLS70R190		700	20	Single	0.17	0.19	2.5	4.5	TO-220, TO-263, TO-220F	
800		HLS70R110	700	47	Single	0.1	0.11	2.5	4	TO-3P, TO-247
		HLS80R1K5	800	4	Single	1.3	1.5	2.5	4	TO-251, TO-252
	HLS80R1K1	800	6	Single	0.95	1.1	2.5	4	TO-251, TO-252, TO-220, TO-263, TO-220F	
	HLS80R300	800	15	Single	0.26	0.3	2.5	4.5	TO-220, TO-263, TO-220F	
	HLS80R250	800	18	Single	0.24	0.28	2.5	4.5	TO-220, TO-263, TO-220F	
	900	HLS90R350	900	15	Single	0.3	0.35	2.5	4.5	TO-220, TO-263, TO-220F
HLS100R500		1000	12	Single	0.4	0.5	2.5	4.5	TO-220, TO-263, TO-220F	
1100		HLS110R550	1100	12	Single	0.41	0.5	2.5	4.5	TO-220, TO-263, TO-220F
		1200	HLS120R800	1200	12	Single	0.62	0.8	2.5	4.5

Multi MOS

Voltage	Part Name	V _{(BR)DSS} (V)	I _b (A)	Configuration	R _{DS(on)-typ} (mΩ) 10V	R _{DS(on)-max} (mΩ) 4.5V	V _{(GS)th-min} (V)	V _{(GS)th-max} (V)	Package
-30	HLT5PD03C	-30	-5	Dual P	37	52	-1	-2.5	SOP-8L
-30	HLT10PD03C	-30	-10	Dual P	13	19	-1	-2.5	SOP-8L
-30	HLT12P03C	-30	-12	Dual P	9.5	14	-1	-2.5	SOP-8L
-60	HLT5PD06C	-60	-5	Dual P	58	-	-1	-3	SOP-8L
20	HLT1ND02EF26	20	0.75	Dual N	-	150	0.4	1.2	DFN2020-6
20	HLG8205A6	20	6	Dual N Common Drain	-	17	0.5	1.2	SOT-23-6
20	HLT1NP02EA6	20 -20	0.5 -0.65	N+P	- -	200 380	0.4 -0.4	1 -1	SOT-23-6
20	HLT3NP02A6	20 -20	3 -3	N+P	- -	28 60	0.5 -0.5	1 -1	SOT-23-6
20	HLT3N2P02A6	20 -20	3 -2	N+P	- -	45 90	0.5 -0.5	1 -1	SOT-23-6
20	HLT10N6P02C	20 -20	10 -6	N+P	- -	12 34	0.5 -0.5	1 -1	SOP-8L
30	HLT9ND03C	30	8.5	Dual N	14	23	1	2.5	SOP-8L
30	HLT12ND03PF4	30	12	Dual N	12	23	1	2.5	PDFN3333-8L
30	HLT12ND03C	30	12	Dual N	7	11	1	2.5	SOP-8L
30	HLT18ND03C	30	18	Dual N	4.5	7.5	1	2.5	SOP-8L
30	HLT30ND03PF4	30	30	Dual N	7	11	1	2.5	PDFN3333-8L
30	HLT15ND03C	30	15	Dual N	4.8	6.6	1	2.5	SOP-8L
30	HLT6NP03C	30 -30	6 -6.5	N+P	25 22	33 34	1 -1	3 -2.5	SOP-8
30	HL30D2519K4	30 -30	25 -19	N+P Common Drain	8.5 28	11.8 48	1 -1	3 -2.5	TO-252-4
30	HLT30NP03PF5	30 -30	35 -30	N+P	9 10.5	11 16	1 -1	2.5 -3	PDFN5060-8L
30	HLT10N9P03C	30 -30	10 -9	N+P	7.5 15	11 21	1 -1	3 -3	SOP-8
40	HLT30N15PK4	40 -40	30 -15	N+P Common Drain	14 29	19 34	1 -1	2.5 -2.5	TO-252-4
40	HLT7ND04C	40	7	Dual N	29	38	1	2.5	SOP-8L
40	HLT9ND04C	40	9	Dual N	18	25	1	2.5	SOP-8L
40	HLT12ND04C	40	12	Dual N	8	11	1	2.5	SOP-8L
40	HLT30N15P04PF5	40 -40	30 -15	N+P	14 29	19 34	1 -1	2.5 -2.5	DFN5060-8
40	HLT8NP04C	40 -40	8 -8	N+P	14 29	19 34	1 -1	2 -2	SOP-8
40	HLT7N5P04C	40 -40	7 -5	N+P	19.5 32	29 39	1 -1	2 -2	SOP-8
60	HLT05ND06C	60	5	Dual N	26	33	1	2.5	SOP-8L
60	HLT07ND06C	60	7	Dual N	18	22	1	2.5	SOP-8L
60	HLT09ND06C	60	9	Dual N	12	16	1	2.5	SOP-8L
60	HLT6NP06C	60 -60	6.3 -6	N+P	26 64	- -	1.2 -1.5	2.5 -3	SOP-8
60	HLT20N12P06K4	60 -60	20 -12	N+P Common Drain	24 84	30 100	1.2 -1	2.5 -2.2	TO-252-4

霍尔传感器 HALL Sensor

霍尔传感器通过检测磁感应强度的变化，从而输出高低数字逻辑，判断物件的移动和位置。有单极、双极、线性、全级性四种类型以及SOT-23-3和TO-92S两种封装形式。拥有全面的开关和锁存解决方案，满足例如接近开关，无触点式定位，流量检测，电机相位检测等应用需求
 广泛应用于汽车、新能源、工控自动化、无刷电机、家电和消费电子等众多行业领域

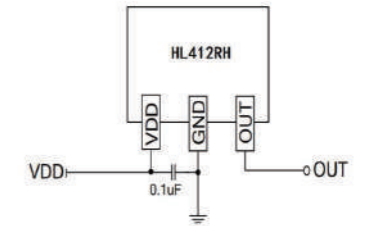

Order P/N	Electrical Characteristics							Reverse Current				
	VIN (V)		IOUT (mA)	BOP (Gauss)	BRP (Gauss)	BHYS (Gauss)	IDD (mA)		Ta(° c)		Reverse Protect	Package Type (V)
	Min.	Max.					Typ.	MAX.	Min.	Max.		
HL412HX Series	4	24	40	30-50	-50--30	80	2.5	4	-55	150	<input checked="" type="checkbox"/>	TO-92S
				10-50	-80--10	60						
				50-80	-80--10	90	4.5	6				
				30-50	-50--30	80						
				10-50	-80--10	60						
HL3100 Series	3	24	50	50	20	30	1	3	-40	85	<input type="checkbox"/>	TO-92S SOT23-3
HL412H Series	3	24	50	25	-25	50	1	3	-40	85	<input checked="" type="checkbox"/>	TO-92S SOT23-3
				-25	25	50	2	3				
				25	-25	50	1	3				
				-25	25	50	2	3				
				25	-25	50	1	3				
HL412RH Series	3	24	50	25	-25	50	1	3	-40	85	<input checked="" type="checkbox"/>	TO-92S SOT23-3
				25	-25	50	1	3				
				-25	25	50	2	3				
				25	-25	50	1	3				
				-25	25	50	2	3				
HL610R	1.7	5.5	1.5	±25	±15	10	-1.0	2.5	-40	125	<input type="checkbox"/>	SOT-23-3 TO-92S
				±35	±25	10						
				±50	±40	10						
HL612X	3	24	50	±55	±25	30	1	3	-40	150	<input checked="" type="checkbox"/>	SOT-23-3 TO-92S
				±85	±55	30						
				±110	±80	30						
				±30	±20	30						
HL4120	3	24	50	15	-15	30	1	3	-40	85	<input checked="" type="checkbox"/>	SOT-23-3 TO-92S
									-40	125		
									-40	150		
HL1300	2.5	5.5	NA	200	-200		1	NA	-20	85	<input type="checkbox"/>	SOT-23-3 TO-92S

Multi MOS

Voltage	Part Name	V _{(BR)DSS} (V)	I _b (A)	Configuration	R _{DS(on)-typ} (mΩ) 10V	R _{DS(on)-max} (mΩ) 4.5V	V _{(GS)th-min} (V)	V _{(GS)th-max} (V)	Package
-30	HLT5PD03C	-30	-5	Dual P	37	52	-1	-2.5	SOP-8L
-30	HLT10PD03C	-30	-10	Dual P	13	19	-1	-2.5	SOP-8L
-30	HLT12P03C	-30	-12	Dual P	9.5	14	-1	-2.5	SOP-8L
-60	HLT5PD06C	-60	-5	Dual P	58	-	-1	-3	SOP-8L
20	HLT1ND02EF26	20	0.75	Dual N	-	150	0.4	1.2	DFN2020-6
20	HLG8205A6	20	6	Dual N Common Drain	-	17	0.5	1.2	SOT-23-6
20	HLT1NP02EA6	20 -20	0.5 -0.65	N+P	- -	200 380	0.4 -0.4	1 -1	SOT-23-6
20	HLT3NP02A6	20 -20	3 -3	N+P	- -	28 60	0.5 -0.5	1 -1	SOT-23-6
20	HLT3N2P02A6	20 -20	3 -2	N+P	- -	45 90	0.5 -0.5	1 -1	SOT-23-6
20	HLT10N6P02C	20 -20	10 -6	N+P	- -	12 34	0.5 -0.5	1 -1	SOP-8L
30	HLT9ND03C	30	8.5	Dual N	14	23	1	2.5	SOP-8L
30	HLT12ND03PF4	30	12	Dual N	12	23	1	2.5	PDFN3333-8L
30	HLT12ND03C	30	12	Dual N	7	11	1	2.5	SOP-8L
30	HLT18ND03C	30	18	Dual N	4.5	7.5	1	2.5	SOP-8L
30	HLT30ND03PF4	30	30	Dual N	7	11	1	2.5	PDFN3333-8L
30	HLT15ND03C	30	15	Dual N	4.8	6.6	1	2.5	SOP-8L
30	HLT6NP03C	30 -30	6 -6.5	N+P	25 22	33 34	1 -1	3 -2.5	SOP-8
30	HL30D2519K4	30 -30	25 -19	N+P Common Drain	8.5 28	11.8 48	1 -1	3 -2.5	TO-252-4
30	HLT30NP03PF5	30 -30	35 -30	N+P	9 10.5	11 16	1 -1	2.5 -3	PDFN5060-8L
30	HLT10N9P03C	30 -30	10 -9	N+P	7.5 15	11 21	1 -1	3 -3	SOP-8
40	HLT30N15PK4	40 -40	30 -15	N+P Common Drain	14 29	19 34	1 -1	2.5 -2.5	TO-252-4
40	HLT7ND04C	40	7	Dual N	29	38	1	2.5	SOP-8L
40	HLT9ND04C	40	9	Dual N	18	25	1	2.5	SOP-8L
40	HLT12ND04C	40	12	Dual N	8	11	1	2.5	SOP-8L
40	HLT30N15P04PF5	40 -40	30 -15	N+P	14 29	19 34	1 -1	2.5 -2.5	DFN5060-8
40	HLT8NP04C	40 -40	8 -8	N+P	14 29	19 34	1 -1	2 -2	SOP-8
40	HLT7N5P04C	40 -40	7 -5	N+P	19.5 32	29 39	1 -1	2 -2	SOP-8
60	HLT05ND06C	60	5	Dual N	26	33	1	2.5	SOP-8L
60	HLT07ND06C	60	7	Dual N	18	22	1	2.5	SOP-8L
60	HLT09ND06C	60	9	Dual N	12	16	1	2.5	SOP-8L
60	HLT6NP06C	60 -60	6.3 -6	N+P	26 64	- -	1.2 -1.5	2.5 -3	SOP-8
60	HLT20N12P06K4	60 -60	20 -12	N+P Common Drain	24 84	30 100	1.2 -1	2.5 -2.2	TO-252-4

霍尔传感器 HALL Sensor

霍尔传感器通过检测磁感应强度的变化，从而输出高低数字逻辑，判断物件的移动和位置。有单极、双极、线性、全级性四种类型以及SOT-23-3和TO-92S两种封装形式。拥有全面的开关和锁存解决方案，满足例如接近开关，无触点式定位，流量检测，电机相位检测等应用需求。广泛应用于汽车、新能源、工控自动化、无刷电机、家电和消费电子等众多行业领域。

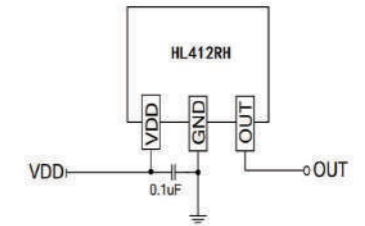

Order P/N	Electrical Characteristics							Reverse Current				
	VIN (V)		IOUT (mA)	BOP (Gauss)	BRP (Gauss)	BHYS (Gauss)	IDD (mA)		Ta(°c)		Reverse Protect	Package Type (V)
	Min.	Max.					Typ.	MAX.	Min.	Max.		
HL412HX Series	4	24	40	30-50	-50--30	80	2.5	4	-55	150	<input checked="" type="checkbox"/>	TO-92S
				10-50	-80--10	60						
				50-80	-80--10	90	4.5	6				
				30-50	-50--30	80						
				10-50	-80--10	60						
HL3100 Series	3	24	50	50	20	30	1	3	-40	85	<input type="checkbox"/>	TO-92S
				-50	-20		2	3				
HL412H Series	3	24	50	25	-25	50	1	3	-40	85	<input checked="" type="checkbox"/>	TO-92S
				-25	25	50	2	3				
				25	-25	50	1	3				
				-25	25	50	2	3				
				25	-25	50	1	3				
HL412RH Series	3	24	50	25	-25	50	1	3	-40	85	<input checked="" type="checkbox"/>	TO-92S
				-25	25	50	2	3				
				-25	25	50	1	3				
				25	-25	50	2	3				
				-25	25	50	2	3				
HL610R	1.7	5.5	1.5	±25	±15	10	-1.0	2.5	-40	125	<input type="checkbox"/>	SOT-23-3
				±35	±25	10						
				±50	±40	10						
HL612X	3	24	50	±55	±25	30	1	3	-40	150	<input checked="" type="checkbox"/>	SOT-23-3
				±85	±55	30						
				±110	±80	30						
				±30	±20	30						
HL4120	3	24	50	15	-15	30	1	3	-40	85	<input checked="" type="checkbox"/>	SOT-23-3
									-40	125		
									-40	150		
HL1300	2.5	5.5	NA	200	-200		1	NA	-20	85	<input type="checkbox"/>	SOT-23-3
												TO-92S

热保护器 YKWA/YKWB

用途

YKWA / YKWB系列热保护器，是对电流、温度双重敏感的热保护器件，为防止因过流、过热而产生的非正常工作提供有效可靠的安全保护。YKWA系列热保护器外壳采用耐高温、热传导快的金属材料制造；YKWB外壳采用耐高温、热传导快的高强度 PBT 工程塑料制造。广泛应用于单相塑料电机，铁壳电机由于过载、堵转等非正常工作状态下引起的过热、过电流保护，也适用于灯具、电池、真空清洗机、PC 板以及变压器等一般电器的过热保护和温度控制。

结构特点

YKWA / YKWB热保护器是采用一定几何形状的双金属片，无需辅助机构，仅靠双金属片的自身感温和电流热效应，使双金属元件的状态发生快速变化，直接带动触点实现自动切断和接通电路，起到过热、过载保护作用。具有体积小、灵敏度高优点。

产品分类、型号及外形结构

- ▲ 产品分类及型号 YKWA / YKWB (设计代号) - XXX (额定动作温度)
- ▲ 外形及结构 热保护器的外形及结构见总装图。

触点额定电容量

AC250V/5A

使用注意事项

- ▲ 温度测试 将热保护器置于恒温精度为 $\pm 1^{\circ}\text{C}$ 的试验箱内进行试验。测温方法采用热电偶或温度计，热电偶或温度计应置于热保护器试样上或尽可能靠近试样，在试验升温过程中，从低于额定动作温度 10°C 开始，温度变化速率不超过 $1^{\circ}\text{C}/\text{min}$ 。通过保护器的测试电流不应超过 0.1A 。
- ▲ 使用环境 保护器不得长期用于 180°C 以上高温环境，防止造成保护器保护温度及绝缘功能失效。不得在强酸、强碱及其它强腐蚀环境下长期使用。
- ▲ 安装与连接 保护器应安装于被保护对象升温的敏感点，与被保护部件有效地紧密接触或直接面向被保护区域。保护器在安装过程中，以防止超出外壳变形或破损而使保护器性能改变，应注意以下几点：
 - 不得使用尖锐的工具对保护器抵压；
 - 不得用重力捶压保护器；
 连接采用电弧法焊接工艺时，焊接电流不得通过热保护器，否则过强电流直接通过热保护器触点会造成破坏作用。

储藏条件

包装箱及部品在运输、贮存过程中均不得遭受雨雪侵袭，挤压与破损，空气相对湿度不大于 90% 。

技术性能

- ▲ 外观性能 热保护器的外壳不得有毛刺、裂纹、变形、锈蚀等现象。标志应正确、端正、清晰、经久耐擦。
- ▲ 引线（端子）抗拉性能 热保护器的引线（端子）应能承受不低于 30N 轴向静拉力，历时 5 秒，应无断裂、松动、脱落现象。
- ▲ 动作特性 额定动作温度热保护器的额定动作温度见附表，热保护器临界脱扣电流温度曲线见附图(仅供参考)
- ▲ 介电性能 热保护器在分断后的引出线应能承受 $\text{AC}660\text{V}$ 试验电压历时 1min 而无击穿闪络现象（泄漏电流整定值 30mA ）。热保护器端子引线与绝缘套管能承受交流 $\text{AC}1500\text{V}$ 试验电压历时 1min 而无击穿闪络现象（泄漏电流整定值 30mA ）。
- ▲ 绝缘性能在正常条件下，引出线（端子）与绝缘套管之间绝缘电阻大于 $100\text{M}\Omega$ （ $\text{DC}500\text{V}$ 兆欧表测量）。
- ▲ 耐久性能 耐湿性能 热保护器应能承受恒定湿热试验方法（ $\text{GB}2423.3\text{Ca}$ ）的考核，其严酷等级为 48h ，湿热试验后的绝缘电阻应不低于 $2\text{M}\Omega$ ，试验后性能应满足下列要求：
 - 试品应无变形破损。
 - 额定动作温度变化应在初期值的 $\pm 5^{\circ}\text{C}$ 或 $\pm 5\%$ (二者取最大者) 以内。
 - 介电强度应符合 5.4.1 条，试验电压为原试验电压的 75% 。
 耐高温性能 将热保护器置于 150°C 的空气环境中保持 24h ，试验后性能应满足下列要求：
 - 试品应无变形破损
 - 额定动作温度变化应在初期值的 $\pm 5^{\circ}\text{C}$ 或 $\pm 5\%$ (二者取最大者) 以内。
 - 介电强度应符合 5.4.1 条，试验电压为原试验电压的 75% 。
 耐低温性能 将热保护器置于 -20°C 的空气环境中保持 48h ，试验后性能应满足下列要求：
 - 试品应无变形破损
 - 额定动作温度变化应在初期值的 $\pm 5^{\circ}\text{C}$ 或 $\pm 5\%$ (二者取最大者) 以内。
 - 介电强度应符合 5.4.1 条，试验电压为原试验电压的 75% 。
 耐热冲击性能 将热保护器置于 150°C ，历时 30min ， -20°C ，历时 30min ，交变放置 5 个周期，试验后性能应温度开关 Trustworthy electronic circuit protection expert YKWA 系列热保护器 2 REV 21.1 满足下列要求：
 - 试品应无变形破损。
 - 额定动作温度变化应在初期值的 $\pm 5^{\circ}\text{C}$ 或 $\pm 5\%$ (二者取最大者) 以内。
 - 介电强度应符合 5.4.1 条，试验电压为原试验电压的 75% 。
 耐振动性能 热保护器应能承受振幅 0.35mm ，频率变化 $10\sim 50\text{Hz}$ ，变化周期 $3\sim 5$ 次/ min ，装夹方向为 X、Y、Z 各试验 1.5h 后，性能应满足下列要求：
 - 额定动作温度变化应在初期值的 $\pm 5^{\circ}\text{C}$ 或 $\pm 5\%$ (二者取最大者) 以内。
 - 试品应无变形破损，端子不应松动脱落。
 寿命 产品在额定电压、电流的条件下，外加热源使其动作 5000 次，应满足下面条件：
 - 动作温度变化应在初始值的 $\pm 5^{\circ}\text{C}$ 以内；
 - 接触电阻应在 $100\text{m}\Omega$ 以下；在额定电压、电流条件下，继续试验至 5000 次后能可靠动作。

热保护器 YKWA/YKWB

用途

YKWA / YKWB系列热保护器，是对电流、温度双重敏感的热保护器件，为防止因过流、过热而产生的非正常工作提供有效可靠的安全保护。YKWA系列热保护器外壳采用耐高温、热传导快的金属材料制造；YKWB外壳采用耐高温、热传导快的高强度 PBT 工程塑料制造。广泛应用于单相塑料电机，铁壳电机由于过载、堵转等非正常工作状态下引起的过热、过电流保护，也适用于灯具、电池、真空清洗机、PC 板以及变压器等一般电器的过热保护和温度控制。

结构特点

YKWA / YKWB热保护器是采用一定几何形状的双金属片，无需辅助机构，仅靠双金属片的自身感温和电流热效应，使双金属元件的状态发生快速变化，直接带动触点实现自动切断和接通电路，起到过热、过载保护作用。具有体积小、灵敏度高优点。

产品分类、型号及外形结构

- ▲ 产品分类及型号 YKWA / YKWB (设计代号) - XXX (额定动作温度)
- ▲ 外形及结构 热保护器的外形及结构见总装图。

触点额定电容量

AC250V/5A

使用注意事项

- ▲ 温度测试 将热保护器置于恒温精度为 $\pm 1^{\circ}\text{C}$ 的试验箱内进行试验。测温方法采用热电偶或温度计，热电偶或温度计应置于热保护器试样上或尽可能靠近试样，在试验升温过程中，从低于额定动作温度 10°C 开始，温度变化速率不超过 $1^{\circ}\text{C}/\text{min}$ 。通过保护器的测试电流不应超过 0.1A 。
- ▲ 使用环境 保护器不得长期用于 180°C 以上高温环境，防止造成保护器保护温度及绝缘功能失效。不得在强酸、强碱及其它强腐蚀环境下长期使用。
- ▲ 安装与连接 保护器应安装于被保护对象升温的敏感点，与被保护部件有效地紧密接触或直接面向被保护区域。保护器在安装过程中，以防止超出外壳变形或破损而使保护器性能改变，应注意以下几点：
 - 不得使用尖锐的工具对保护器抵压；
 - 不得用重力捶压保护器；
 连接采用电弧法焊接工艺时，焊接电流不得通过热保护器，否则过强电流直接通过热保护器触点会造成破坏作用。

储藏条件

包装箱及部品在运输、贮存过程中均不得遭受雨雪侵袭，挤压与破损，空气相对湿度不大于 90% 。

技术性能

- ▲ 外观性能 热保护器的外壳不得有毛刺、裂纹、变形、锈蚀等现象。标志应正确、端正、清晰、经久耐擦。
- ▲ 引线（端子）抗拉性能 热保护器的引线（端子）应能承受不低于 30N 轴向静拉力，历时 5 秒，应无断裂、松动、脱落现象。
- ▲ 动作特性 额定动作温度热保护器的额定动作温度见附表，热保护器临界脱扣电流温度曲线见附图(仅供参考)
- ▲ 介电性能 热保护器在分断后的引出线应能承受 $\text{AC}660\text{V}$ 试验电压历时 1min 而无击穿闪络现象（泄漏电流整定值 30mA ）。热保护器端子引线与绝缘套管能承受交流 $\text{AC}1500\text{V}$ 试验电压历时 1min 而无击穿闪络现象（泄漏电流整定值 30mA ）。
- ▲ 绝缘性能在正常条件下，引出线（端子）与绝缘套管之间绝缘电阻大于 $100\text{M}\Omega$ （ $\text{DC}500\text{V}$ 兆欧表测量）。
- ▲ 耐久性能 耐湿性能 热保护器应能承受恒定湿热试验方法（ $\text{GB}2423.3\text{Ca}$ ）的考核，其严酷等级为 48h ，湿热试验后的绝缘电阻应不低于 $2\text{M}\Omega$ ，试验后性能应满足下列要求：
 - 试品应无变形破损。
 - 额定动作温度变化应在初期值的 $\pm 5^{\circ}\text{C}$ 或 $\pm 5\%$ (二者取最大者) 以内。
 - 介电强度应符合 5.4.1 条，试验电压为原试验电压的 75% 。
 耐高温性能 将热保护器置于 150°C 的空气环境中保持 24h ，试验后性能应满足下列要求：
 - 试品应无变形破损
 - 额定动作温度变化应在初期值的 $\pm 5^{\circ}\text{C}$ 或 $\pm 5\%$ (二者取最大者) 以内。
 - 介电强度应符合 5.4.1 条，试验电压为原试验电压的 75% 。
 耐低温性能 将热保护器置于 -20°C 的空气环境中保持 48h ，试验后性能应满足下列要求：
 - 试品应无变形破损
 - 额定动作温度变化应在初期值的 $\pm 5^{\circ}\text{C}$ 或 $\pm 5\%$ (二者取最大者) 以内。
 - 介电强度应符合 5.4.1 条，试验电压为原试验电压的 75% 。
 耐热冲击性能 将热保护器置于 150°C ，历时 30min ， -20°C ，历时 30min ，交变放置 5 个周期，试验后性能应温度开关 Trustworthy electronic circuit protection expert YKWA 系列热保护器 2 REV 21.1 满足下列要求：
 - 试品应无变形破损。
 - 额定动作温度变化应在初期值的 $\pm 5^{\circ}\text{C}$ 或 $\pm 5\%$ (二者取最大者) 以内。
 - 介电强度应符合 5.4.1 条，试验电压为原试验电压的 75% 。
 耐振动性能 热保护器应能承受振幅 0.35mm ，频率变化 $10\sim 50\text{Hz}$ ，变化周期 $3\sim 5$ 次/ min ，装夹方向为 X、Y、Z 各试验 1.5h 后，性能应满足下列要求：
 - 额定动作温度变化应在初期值的 $\pm 5^{\circ}\text{C}$ 或 $\pm 5\%$ (二者取最大者) 以内。
 - 试品应无变形破损，端子不应松动脱落。
 寿命 产品在额定电压、电流的条件下，外加热源使其动作 5000 次，应满足下面条件：
 - 动作温度变化应在初始值的 $\pm 5^{\circ}\text{C}$ 以内；
 - 接触电阻应在 $100\text{m}\Omega$ 以下；在额定电压、电流条件下，继续试验至 5000 次后能可靠动作。

额定规格的断开，接通温度范围对照表

规格 Specifications	断开温度范围 Open	接通温度范围 Close	规格 Specifications	断开温度范围 Open	接通温度范围 Close
45℃	45℃ ± 5.0℃	30 ± 8.0℃	100℃	100℃ ± 5.0℃	70 ± 15.0℃
50℃	50℃ ± 5.0℃	35 ± 8.0℃	105℃	105℃ ± 5.0℃	70 ± 15.0℃
55℃	55℃ ± 5.0℃	35 ± 10.0℃	110℃	110℃ ± 5.0℃	75 ± 15.0℃
60℃	60℃ ± 5.0℃	40 ± 10.0℃	115℃	115℃ ± 5.0℃	75 ± 15.0℃
65℃	65℃ ± 5.0℃	45 ± 12.0℃	120℃	120℃ ± 5.0℃	80 ± 15.0℃
70℃	70℃ ± 5.0℃	45 ± 15.0℃	125℃	125℃ ± 5.0℃	85 ± 15.0℃
75℃	75℃ ± 5.0℃	50 ± 15.0℃	130℃	130℃ ± 5.0℃	85 ± 15.0℃
80℃	80℃ ± 5.0℃	55 ± 15.0℃	135℃	135℃ ± 5.0℃	90 ± 15.0℃
85℃	85℃ ± 5.0℃	55 ± 15.0℃	140℃	140℃ ± 5.0℃	95 ± 15.0℃
90℃	90℃ ± 5.0℃	60 ± 15.0℃	145℃	145℃ ± 5.0℃	95 ± 15.0℃
95℃	95℃ ± 5.0℃	65 ± 15.0℃	150℃	150℃ ± 5.0℃	100 ± 15.0℃

触点最大容量

YKWA、YKWB 系列热保护器在下列条件下可断开接通保护 5000 次 电压 AC250V 电流 5A。

A-℃ 曲线图

临界脱扣电流与周围温度曲线（仅用于选择认证试验）



尺寸

型号	L	W	H	导线
YKWA	15 ± 0.4	6.5 ± 0.2	3.1 ± 0.1	20# Red Silica Gel Line
YKWB	15.5 ± 0.4	7.3 ± 0.2	3.9 ± 0.1	22#1430 或者 3266 白色电子线 常规线长 70mm, 可定制

构造:

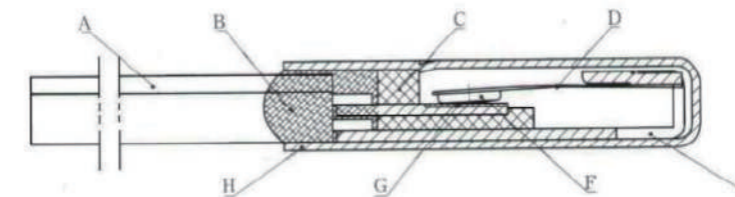

A 导线 B 环氧树脂 C 固定座 D 双金属元件 E 支架 F 触点 G 静触片 H 外壳

额定规格的断开，接通温度范围对照表

规格 Specifications	断开温度范围 Open	接通温度范围 Close	规格 Specifications	断开温度范围 Open	接通温度范围 Close
45℃	45℃ ± 5.0℃	30 ± 8.0℃	100℃	100℃ ± 5.0℃	70 ± 15.0℃
50℃	50℃ ± 5.0℃	35 ± 8.0℃	105℃	105℃ ± 5.0℃	70 ± 15.0℃
55℃	55℃ ± 5.0℃	35 ± 10.0℃	110℃	110℃ ± 5.0℃	75 ± 15.0℃
60℃	60℃ ± 5.0℃	40 ± 10.0℃	115℃	115℃ ± 5.0℃	75 ± 15.0℃
65℃	65℃ ± 5.0℃	45 ± 12.0℃	120℃	120℃ ± 5.0℃	80 ± 15.0℃
70℃	70℃ ± 5.0℃	45 ± 15.0℃	125℃	125℃ ± 5.0℃	85 ± 15.0℃
75℃	75℃ ± 5.0℃	50 ± 15.0℃	130℃	130℃ ± 5.0℃	85 ± 15.0℃
80℃	80℃ ± 5.0℃	55 ± 15.0℃	135℃	135℃ ± 5.0℃	90 ± 15.0℃
85℃	85℃ ± 5.0℃	55 ± 15.0℃	140℃	140℃ ± 5.0℃	95 ± 15.0℃
90℃	90℃ ± 5.0℃	60 ± 15.0℃	145℃	145℃ ± 5.0℃	95 ± 15.0℃
95℃	95℃ ± 5.0℃	65 ± 15.0℃	150℃	150℃ ± 5.0℃	100 ± 15.0℃

触点最大容量

YKWA、YKWB 系列热保护器在下列条件下可断开接通保护 5000 次 电压 AC250V 电流 5A。

A-℃ 曲线图

临界脱扣电流与周围温度曲线（仅用于选择认证试验）



尺寸

型号	L	W	H	导线
YKWA	15 ± 0.4	6.5 ± 0.2	3.1 ± 0.1	20# Red Silica Gel Line
YKWB	15.5 ± 0.4	7.3 ± 0.2	3.9 ± 0.1	22#1430 或者 3266 白色电子线 常规线长 70mm, 可定制

构造:

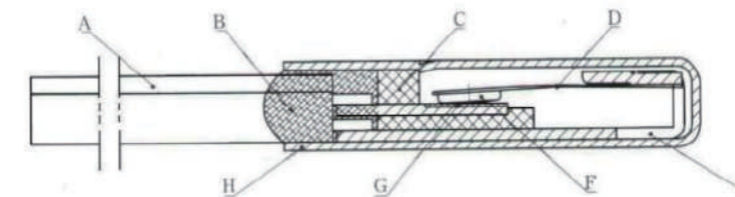

A 导线 B 环氧树脂 C 固定座 D 双金属元件 E 支架 F 触点 G 静触片 H 外壳

共模滤波器 CMF (Common Mode Filter)

Features and Application

- ▲ Powerful components with composite co-fired material to solve EMI problem for high speed differential signal transmission line as
- ▲ MIPI, MHL serial interface in mobile device.

PART NUMBER CODE



- Series name
- Dimensions L*W
- Material code
- Product identification number
- Impedance (ex: 900=90Ω)
- Rated Current Code
A50mA B80mA C100mA D150mA E200mA F300mA G400mA H500mA J700mA K800mA
- YINT internal code
- Packaging style: P-Paper tape, 7" reel

YC2M 2012Bseries

Part No.	Imp. Com.(Ω) ± 25%@100MHz	DCR Max. (Ω)	Rated Current Max.(mA)	Rated Voltage (V)	Withstand Voltage(V)	Insulation Resistance Min.(MΩ)
YC2M2012B670GBE	67	0.4	400	10	25	200
YC2M2012B900GBE	90	0.4	400	10	25	200
YC2M2012B121GBE	120	0.4	400	10	25	200
YC2M2012B161GBE	160	0.5	400	10	25	200
YC2M2012B181GBE	180	0.5	400	10	25	200
YC2M2012B221FBE	220	0.5	300	10	25	200

SHAPES AND DIMENSIONS

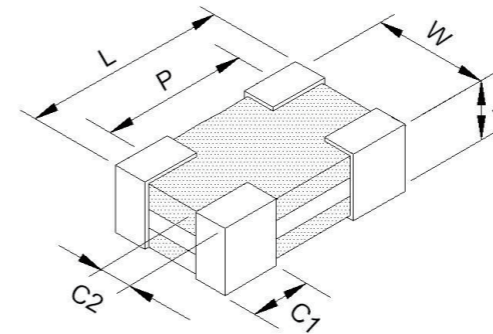

TYPE	Dimension
L	2.00 ± 0.20
W	1.25 ± 0.20
T	1.00 ± 0.10
P	1.60 ± 0.20
C1	0.40 ± 0.20
C2	0.30 ± 0.20
Unit: mm	

CIRCUIT CONFIGURATION & LAYOUT PAD

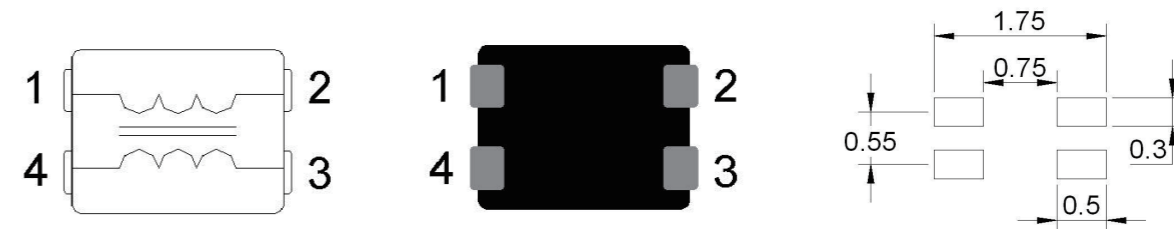

共模滤波器 CMF (Common Mode Filter)

Features and Application

- ▲ Powerful components with composite co-fired material to solve EMI problem for high speed differential signal transmission line as
- ▲ MIPI, MHL serial interface in mobile device.

PART NUMBER CODE



1. Series name
2. Dimensions L*W
3. Material code
4. Product identification number
5. Impedance (ex: 900=90Ω)
6. Rated Current Code
A50mA B80mA C100mA D150mA E200mA F300mA G400mA H500mA J700mA K800mA
7. YINT internal code
8. Packaing style: P-Paper tape, 7" reel

YC2M 2012Bseries

Part No.	Imp. Com.(Ω) ± 25%@100MHz	DCR Max. (Ω)	Rated Current Max.(mA)	Rated Voltage (V)	Withstand Voltage(V)	Insulation Resistance Min.(MΩ)
YC2M2012B670GBE	67	0.4	400	10	25	200
YC2M2012B900GBE	90	0.4	400	10	25	200
YC2M2012B121GBE	120	0.4	400	10	25	200
YC2M2012B161GBE	160	0.5	400	10	25	200
YC2M2012B181GBE	180	0.5	400	10	25	200
YC2M2012B221FBE	220	0.5	300	10	25	200

SHAPES AND DIMENSIONS

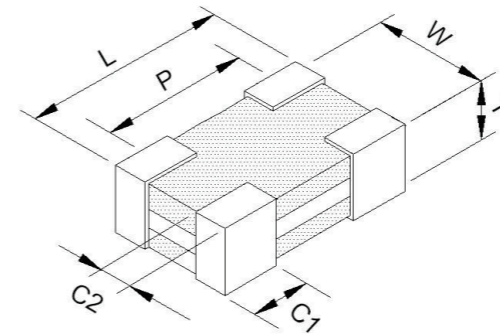

TYPE	Dimension
L	2.00 ± 0.20
W	1.25 ± 0.20
T	1.00 ± 0.10
P	1.60 ± 0.20
C1	0.40 ± 0.20
C2	0.30 ± 0.20
Unit: mm	

CIRCUIT CONFIGURATION & LAYOUT PAD



YC2H 2012G Series

Part No.	Imp. Com.(Ω) \pm 25%@100MHz	DCR Max. (Ω)	Rated Current Max.(mA)	Rated Voltage(V)	Insulation Resistance Min.(M Ω)
YC2H2012GH670EAE	67	1	200	10	100
YC2H2012GH900EAE	90	1	200	10	100
YC2H2012GD500CAE	50	1	100	10	100
YC2H2012GD900EAE	90	1	200	10	100
YC2H2012GD121CAE	120	1.2	100	10	100

SHAPES AND DIMENSIONS

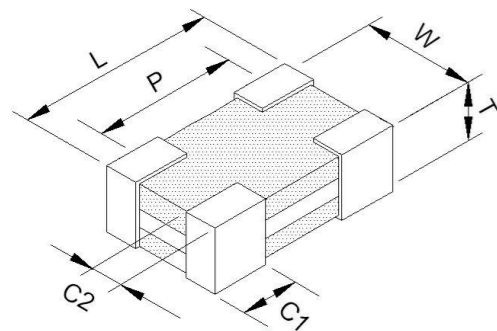

TYPE	Dimension
L	2.00 \pm 0.20
W	1.20 \pm 0.20
T	1.00 \pm 0.10
P	1.60 \pm 0.20
C1	0.40 \pm 0.20
C2	0.30 \pm 0.20
Unit: mm	

CIRCUIT CONFIGURATION & LAYOUT PAD

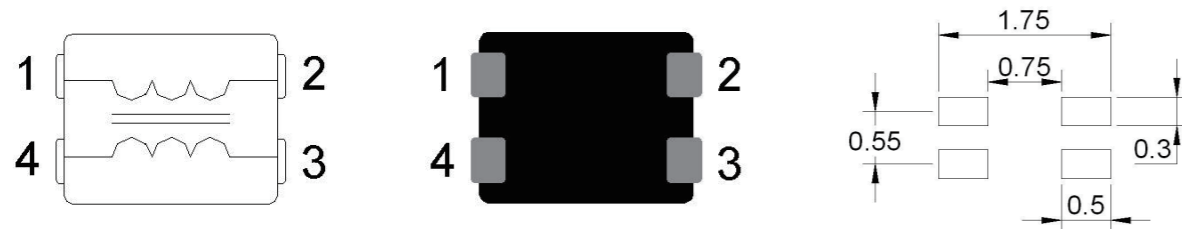

YC2M 1012B series

Part No.	Imp. Com.(Ω) \pm 25%@100MHz	DCR Max. (Ω)	Rated Current Max.(mA)	Rated Voltage (V)	Withstand Voltage(V)	Insulation Resistance Min.(M Ω)
YC2M1012B670FBP	67	0.5	300	10	25	200
YC2M1012B900FBP	90	0.6	300	10	25	200
YC2M1012B121FBP	120	0.6	300	10	25	200

SHAPES AND DIMENSIONS

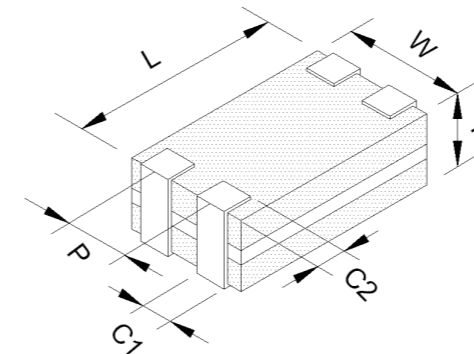

TYPE	Dimension
L	1.25 \pm 0.10
W	1.00 \pm 0.10
T	0.60 \pm 0.10
P	0.50 \pm 0.10
C1	0.30 \pm 0.10
C2	0.20 \pm 0.15
Unit: mm	

CIRCUIT CONFIGURATION & LAYOUT PAD

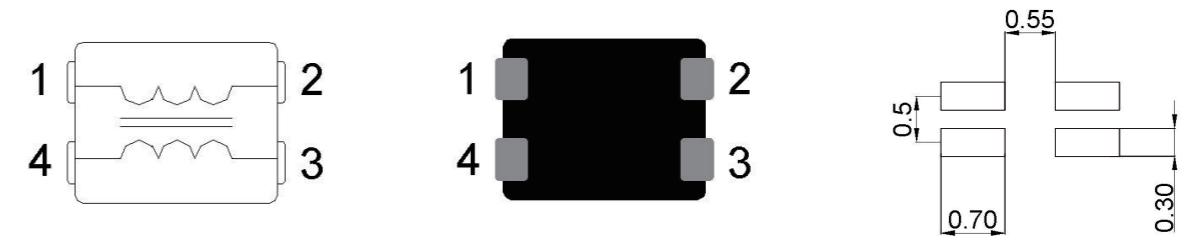

YC2H 2012G Series

Part No.	Imp. Com.(Ω) \pm 25%@100MHz	DCR Max. (Ω)	Rated Current Max.(mA)	Rated Voltage(V)	Insulation Resistance Min.(M Ω)
YC2H2012GH670EAE	67	1	200	10	100
YC2H2012GH900EAE	90	1	200	10	100
YC2H2012GD500CAE	50	1	100	10	100
YC2H2012GD900EAE	90	1	200	10	100
YC2H2012GD121CAE	120	1.2	100	10	100

SHAPES AND DIMENSIONS

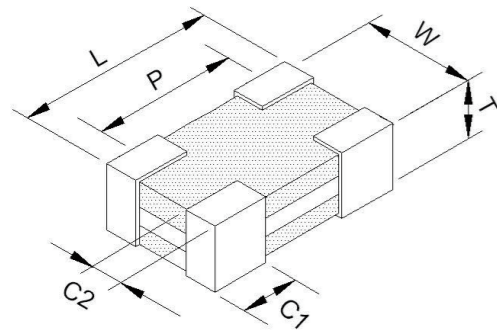

TYPE	Dimension
L	2.00 \pm 0.20
W	1.20 \pm 0.20
T	1.00 \pm 0.10
P	1.60 \pm 0.20
C1	0.40 \pm 0.20
C2	0.30 \pm 0.20
Unit: mm	

CIRCUIT CONFIGURATION & LAYOUT PAD

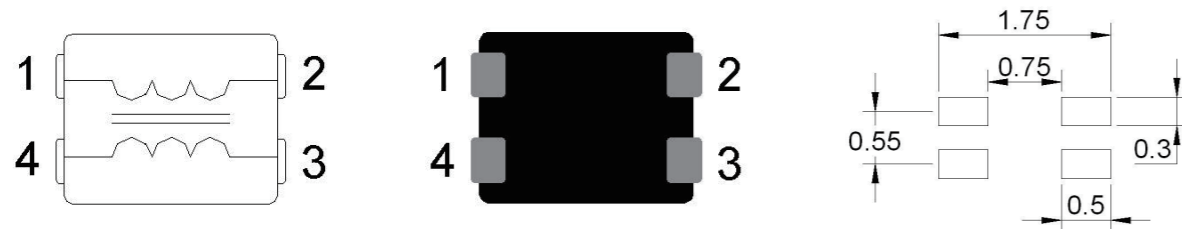

YC2M 1012B series

Part No.	Imp. Com.(Ω) \pm 25%@100MHz	DCR Max. (Ω)	Rated Current Max.(mA)	Rated Voltage (V)	Withstand Voltage(V)	Insulation Resistance Min.(M Ω)
YC2M1012B670FBP	67	0.5	300	10	25	200
YC2M1012B900FBP	90	0.6	300	10	25	200
YC2M1012B121FBP	120	0.6	300	10	25	200

SHAPES AND DIMENSIONS

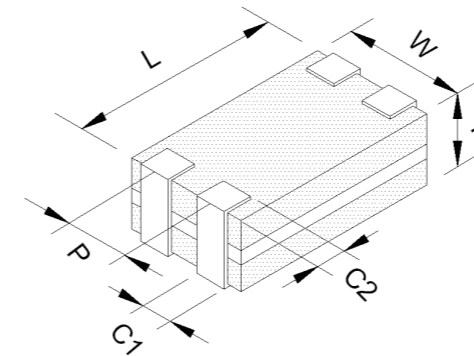

TYPE	Dimension
L	1.25 \pm 0.10
W	1.00 \pm 0.10
T	0.60 \pm 0.10
P	0.50 \pm 0.10
C1	0.30 \pm 0.10
C2	0.20 \pm 0.15
Unit: mm	

CIRCUIT CONFIGURATION & LAYOUT PAD

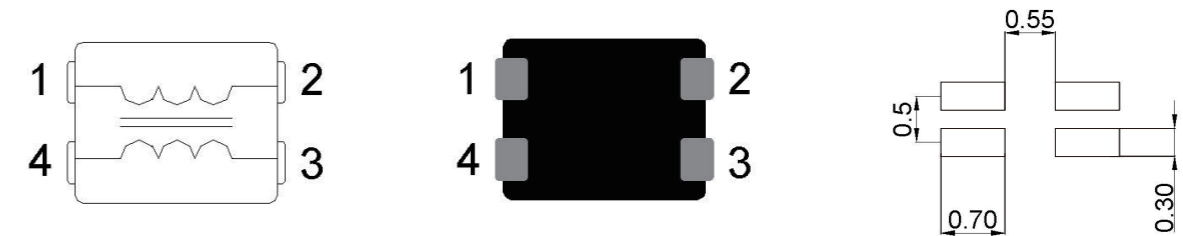

YC2H 1012G series

Part No.	Imp. Com.(Ω) ± 25%@100MHz	DCR Max. (Ω)	Rated Current Max.(mA)	Rated Voltage(V)	Insulation Resistance Min.(MΩ)
YC2H1012GD500CAP	50	1.5	100	10	100
YC2H1012GD670CAP	67	1.5	100	10	100
YC2H1012GD900CAP	90	1.5	100	10	100
YC2H1012GD900CBP	90	3	100	10	100
YC2H1012GS150CAP	15	0.8	100	10	100

SHAPES AND DIMENSIONS

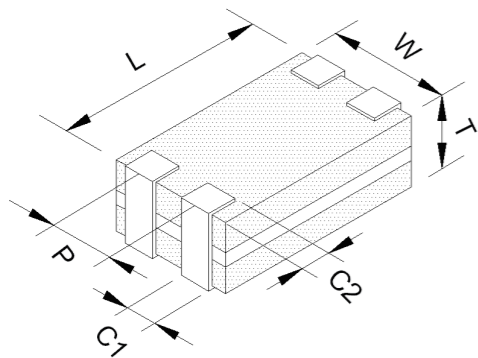

TYPE	Dimension
L	1.25 ± 0.10
W	1.00 ± 0.10
T	0.50 ± 0.10
P	0.55 ± 0.10
C1	0.30 ± 0.10
C2	0.20 ± 0.15
Unit: mm	

CIRCUIT CONFIGURATION & LAYOUT PAD

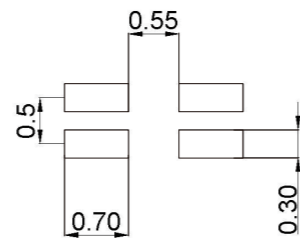
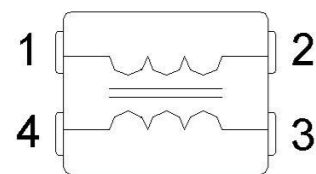

低压差线性稳压器 LDO (Low Dropout Regulator)

传统的线性稳压器，要求输入电压要比输出电压至少高出2V~3V，否则就不能正常工作；如果输入电压和输出电压很接近，最好是选用LDO稳压器。

电压级别及应用领域

电压输出级别	应用领域
1.25V	ARM9, FPGA, DSP等
1.8V	SDRAM, DDR RAM等
2.5V	MCU, DDR RAM等
3.0V	MCU, Nor Flash, Nand Flash, 其他各种接口器件等

LDO特性及应用方向

特性

- ▲ 超低纹波，高精度
- ▲ 低压差
- ▲ 低静态电流
- ▲ 电压监控
- ▲ 复位控制
- ▲ 多通道输出

应用方向

- ▲ 数据采集
- ▲ 电池供电
- ▲ 低功耗场合，如手持仪表
- ▲ 嵌入系统电源管理
- ▲ 工业控制
- ▲ 需要多路供电的嵌入式系统

YC2H 1012G series

Part No.	Imp. Com.(Ω) \pm 25%@100MHz	DCR Max. (Ω)	Rated Current Max.(mA)	Rated Voltage(V)	Insulation Resistance Min.(M Ω)
YC2H1012GD500CAP	50	1.5	100	10	100
YC2H1012GD670CAP	67	1.5	100	10	100
YC2H1012GD900CAP	90	1.5	100	10	100
YC2H1012GD900CBP	90	3	100	10	100
YC2H1012GS150CAP	15	0.8	100	10	100

SHAPES AND DIMENSIONS

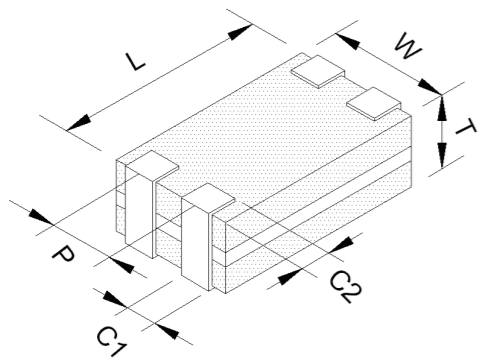

TYPE	Dimension
L	1.25 ± 0.10
W	1.00 ± 0.10
T	0.50 ± 0.10
P	0.55 ± 0.10
C1	0.30 ± 0.10
C2	0.20 ± 0.15
Unit: mm	

CIRCUIT CONFIGURATION & LAYOUT PAD

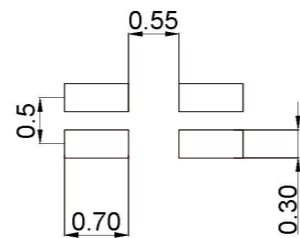
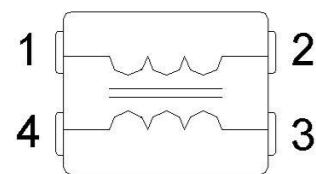

低压差线性稳压器 LDO (Low Dropout Regulator)

传统的线性稳压器，要求输入电压要比输出电压至少高出2V~3V，否则就不能正常工作；如果输入电压和输出电压很接近，最好是选用LDO稳压器。

电压级别及应用领域

电压输出级别	应用领域
1.25V	ARM9, FPGA, DSP等
1.8V	SDRAM, DDR RAM等
2.5V	MCU, DDR RAM等
3.0V	MCU, Nor Flash, Nand Flash, 其他各种接口器件等

LDO特性及应用方向

特性

- ▲ 超低纹波，高精度
- ▲ 低压差
- ▲ 低静态电流
- ▲ 电压监控
- ▲ 复位控制
- ▲ 多通道输出

应用方向

- ▲ 数据采集
- ▲ 电池供电
- ▲ 低功耗场合，如手持仪表
- ▲ 嵌入系统电源管理
- ▲ 工业控制
- ▲ 需要多路供电的嵌入式系统

Low Dropout Regulator

Part Name	Vin (V)	Vout (V)	Iout (mA)	Iq (uA)	Feature	Package
HL6201	12	1.5~5	250	2	Low power dissipation	SOT-23-3, SOT-89, STO-23-5
HL6202	15	1.5~5	150	2		SOT-23-3, SOT-89
HL6205	8	1.2~5	300	1.5		SOT-23, SOT-23-3, SOT-89
HL6206	8	1.2~5	300	3		SOT-23, SOT-23-3, SOT-89
HL62FP	10	1.5~6	350	2		SOT-89
HL71XXM	15	2~5	50	2		SOT-23, SOT-89, TO-92
HL75XXM	15	2~5	150	2		SOT-23, SOT-89, TO-92
HL73XXM	15	1.5~5	250	2		SOT-23, SOT-89, TO-92
HL72XX	15	1.5~5	350	2		SOT-23, SOT-89, TO-92
HL78LXX	18	5/6/8/9/12	100	3000		Bipolarity, Stable voltage
HL78LXXB	18	5/6/8/9/12	300	3000	SOT-89, TO-92	
HL78MXX	36	5/6/8/9/12	500	3000	TO-252	
HL78XX	36	5/6/8/9/12	1000	3000	TO-220	
HL431	36	2.5	100	-	Standard voltage source	SOT-23, TO-92
HL1117	15	1.2/1.8/2.5/2.85/3.3/5/ADJ	1000	2000	Bipolarity 1A LDO	SOT-223, TO-252
HL6219	8	1.2~5	300	30	Low noise	SOT-23-3, SOT-89, STO-23-5
HL6211	8	1.2~5	400	30		SOT-23-3, SOT-89, STO-23-5
HL6221	15	1.6~5	300	10	High ripple rejection ratio	SOT-23-3, SOT-89, STO-23-5
HL6250	8	0.6~5	1000	25	High Ripple, High Current	SOT-89, TO-220
HL6251	8	0.6~5	1000	2	Low power dissipation,	SOT-89, TO-220
HL71XXH	40	2~5	30	3.5	High current	SOT-23, SOT-89, TO-92
HL75XXH	40	2~5	100	3.5	High Voltage Resistance	SOT-23, SOT-89, TO-92
HL1118	15	1.8/3.3	1000	2000	Bipolarity, Dual channel, 1A LDO	SOP8

EMC Laboratory

ESD静电测试仪



符合标准
IEC61000-4-2
GB/T 17626.2
输出电压
接触放电 ±0.1-20kV
空气放电 ±0.1-20kV

雷击浪涌发生器



符合标准
IEC61000-4-5和GB/T17626.5
10/700 μs 5/320 μs
输出电压
0-6000V
0-250A

雷击浪涌发生器



符合标准
IEC61000-4-5和GB/T17626.5
1.2/50 μs-8/20 μs
0-6000V
0-3000A

汽车电子干扰模拟器P5a



符合标准
ISO7637-2、GB/T21437.2
12V系统 24V系统
脉冲电压Us 40~100V 100~200V
输入阻抗Ri 0.5~8Ω
可调 脉冲宽度td 40ms~400ms
可调 上升沿tr 5ms~10ms
可调 脉冲间隔T1 1min~5min
脉冲次数N 1~99次

汽车电子干扰模拟器p5b



符合标准
ISO7637-2、GB/T21437.2
12V系统 24V系统
脉冲电压Us 40~100 V 100~200V
输入阻抗Ri 0.5~8Ω
可调 脉冲宽度td 40~400ms
可调 上升沿tr 5~10ms
可调 脉冲间隔T1 1min~5min
脉冲次数N 1~99次

脉冲群发生器



符合标准
IEC 61000-4-4
GB/T 17626.4
开路输出电压0.25-6KV
脉冲频率1KHz-1200KHz
脉冲前沿5ns ± 30%
脉冲宽度50ns ± 30%, 50Ω
50ns - 15/+100ns, 1000Ω
脉冲串长度个数在1-255可调

Low Dropout Regulator

Part Name	Vin (V)	Vout (V)	Iout (mA)	Iq (uA)	Feature	Package
HL6201	12	1.5~5	250	2	Low power dissipation	SOT-23-3, SOT-89, STO-23-5
HL6202	15	1.5~5	150	2		SOT-23-3, SOT-89
HL6205	8	1.2~5	300	1.5		SOT-23, SOT-23-3, SOT-89
HL6206	8	1.2~5	300	3		SOT-23, SOT-23-3, SOT-89
HL62FP	10	1.5~6	350	2		SOT-89
HL71XXM	15	2~5	50	2		SOT-23, SOT-89, TO-92
HL75XXM	15	2~5	150	2		SOT-23, SOT-89, TO-92
HL73XXM	15	1.5~5	250	2		SOT-23, SOT-89, TO-92
HL72XX	15	1.5~5	350	2		SOT-23, SOT-89, TO-92
HL78LXX	18	5/6/8/9/12	100	3000		Bipolarity, Stable voltage
HL78LXXB	18	5/6/8/9/12	300	3000	SOT-89, TO-92	
HL78MXX	36	5/6/8/9/12	500	3000	TO-252	
HL78XX	36	5/6/8/9/12	1000	3000	TO-220	
HL431	36	2.5	100	-	Standard voltage source	SOT-23, TO-92
HL1117	15	1.2/1.8/2.5/2.85/3.3/5/ADJ	1000	2000	Bipolarity 1A LDO	SOT-223, TO-252
HL6219	8	1.2~5	300	30	Low noise	SOT-23-3, SOT-89, STO-23-5
HL6211	8	1.2~5	400	30		SOT-23-3, SOT-89, STO-23-5
HL6221	15	1.6~5	300	10	High ripple rejection ratio	SOT-23-3, SOT-89, STO-23-5
HL6250	8	0.6~5	1000	25	High Ripple, High Current	SOT-89, TO-220
HL6251	8	0.6~5	1000	2	Low power dissipation,	SOT-89, TO-220
HL71XXH	40	2~5	30	3.5	High current	SOT-23, SOT-89, TO-92
HL75XXH	40	2~5	100	3.5	High Voltage Resistance	SOT-23, SOT-89, TO-92
HL1118	15	1.8/3.3	1000	2000	Bipolarity, Dual channel, 1A LDO	SOP8

EMC Laboratory

ESD静电测试仪



符合标准
IEC61000-4-2
GB/T 17626.2
输出电压
接触放电 ±0.1-20kV
空气放电 ±0.1-20kV

雷击浪涌发生器



符合标准
IEC61000-4-5和GB/T17626.5
10/700 μs 5/320 μs
输出电压
0-6000V
0-250A

雷击浪涌发生器



符合标准
IEC61000-4-5和GB/T17626.5
1.2/50 μs-8/20 μs
0-6000V
0-3000A

汽车电子干扰模拟器P5a



符合标准
ISO7637-2、GB/T21437.2
12V系统 24V系统
脉冲电压Us 40~100V 100~200V
输入阻抗Ri 0.5~8Ω
可调 脉冲宽度td 40ms~400ms
可调 上升沿tr 5ms~10ms
可调 脉冲间隔T1 1min~5min
脉冲次数N 1~99次

汽车电子干扰模拟器p5b



符合标准
ISO7637-2、GB/T21437.2
12V系统 24V系统
脉冲电压Us 40~100 V 100~200V
输入阻抗Ri 0.5~8Ω
可调 脉冲宽度td 40~400ms
可调 上升沿tr 5~10ms
可调 脉冲间隔T1 1min~5min
脉冲次数N 1~99次

脉冲群发生器



符合标准
IEC 61000-4-4
GB/T 17626.4
开路输出电压0.25-6KV
脉冲频率1KHz-1200KHz
脉冲前沿5ns ± 30%
脉冲宽度50ns ± 30%, 50Ω
50ns - 15/+100sn, 1000Ω
脉冲串长度个数在1-255可调

PRODUCTS CATALOG

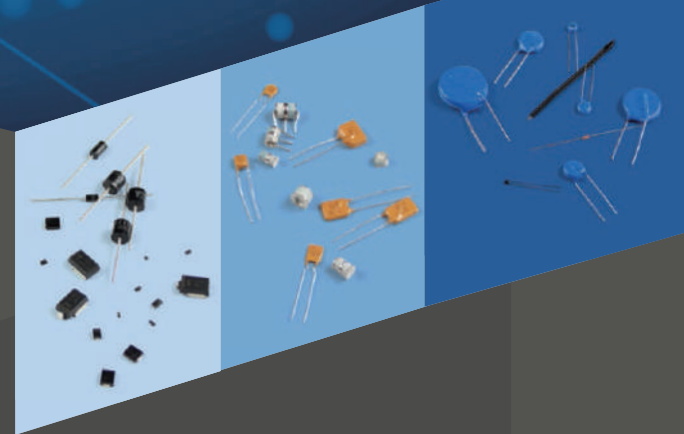

电路保护元器件制造商
解决方案服务商

MANUFACTURER OF CIRCUIT PROTECTION COMPONENTS
PROVIDER OF SOLUTION

选音特就是选品质

CHOOSING YINT IS TO CHOOSE QUALITY

公司总部（华东地区）

中国上海市松江区广富林东路199号启迪漕河泾（中山）科技园水木园9幢4层
Floor 4, No.9 Building, Tus-Caohejing (Zhongshan) Science Park No.199, East Guangfulin Road,
Songjiang District, Shanghai, China
Tel: +86-21-22817629
Fax: +86-21-67689607
Email: sales@yint.com.cn

音特技术研究院

中国上海市松江工业区车墩镇泖亭路188弄财富兴园·国际企业园35号101栋
No.101 Building, No.35 Fortune Zone International Office Park, No.188 Lane, Maoting Road,
Chedun Town, Songjiang District, Shanghai, China

工厂地址

安徽省芜湖市湾沓区新芜经济技术开发区中兴五路领特工业园1栋
No.1 Building, Leader Industrial Park, Zhongxing No.5 Road, Xinwu Economic Development
Zone, Wanzhi District, Wuhu, Anhui Province, China
广东省汕头市龙湖区浦江路电子工业园6栋
No.6 Building, Electronic Industrial Park, Pujiang Road, Longhu District, Shantou, Guangdong
Province, China

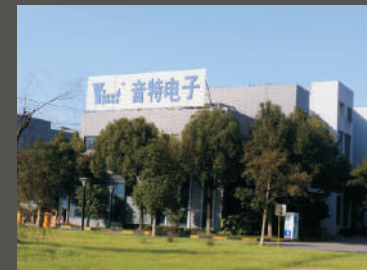

华南地区

深圳市宝安区28区大宝路金富来大厦B座3层
3/F, Building B, Jin Fulai Plaza, Dabao Road, No.28 Zone,
Baoan District, Shenzhen
Tel: +86-755-86655040
Fax: +86-755-86655115
Email: sales@yint.com.cn

西南地区

重庆市南岸区茶园新区同景路5号同景国际广场S1组团A2栋23-1
Room 23-1, Building A2, S1 Zone, Tongjing International Plaza,
No.5 Tongjing Road, Chayuan Area, Nanan District, Chongqing
Tel: +86-23-62948995
Fax: +86-23-62937530
Email: cq@yint.com.cn

印度地区

No.11-12 Aradhana, Classic Paradise Layout, Begur,
Bangalore 560068, Karnataka, India
Tel: +00919945512488 Email: india@yint.com.cn

华北地区

北京市昌平区黄平路19号龙旗广场D座10层1001
Room 101, 10/F, Building D, No.19 Longqqi Plaza, Huangping Road,
Changping District, Beijing
Tel: +86-10-82616984
Fax: +86-10-82616984-621
Email: bj@yint.com.cn

中部地区

河南省郑州市高新区科学大道盛龙友谊公园B座15楼
15F, Tower B, Shenglong Youyi Park, Science Avenue, High-Tech
Zone, Zhengzhou City, Henan
Tel: 0371-66855917-803
Fax: 0371-66859535
Email: saleshn@yint.com.cn

本手册最终解释权归音特电子。手册内容如有变更恕不另行通知。
The right of final interpretation of this catalog belongs to YINT ELECTRONICS.
Catalog is subject to change without notice.

X-ON Electronics

Largest Supplier of Electrical and Electronic Components

Click to view similar products for [Zener Diodes](#) category:

Click to view products by [Yint](#) manufacturer:

Other Similar products are found below :

[RKZ13B2KG#P1](#) [DL5234B](#) [1N4682](#) [1N4693](#) [1N4732A](#) [1N4736A](#) [1N4750A](#) [1N4759ARL](#) [1N5241B](#) [1N5365B](#) [1N5369B](#) [1N747A](#)
[1N964B](#) [1N966B](#) [1N968B](#) [1N972B](#) [JANS1N4974US](#) [1N4692](#) [1N4702](#) [1N4704](#) [1N4711](#) [1N4714](#) [1N4745ARL](#) [1N4752ARL](#) [1N4760ARL](#)
[1N5221B](#) [1N5242BTR](#) [1N5350B](#) [1N5352B](#) [1N961BRR1](#) [1N964BRL](#) [RKZ5.1BKU#P6](#) [3SMAJ5946B-TP](#) [3SMAJ5950B-TP](#)
[MMSZ5230BQ-13-F](#) [MMSZ5232BQ-13-F](#) [BZX84C7V5](#) [3SMAJ5945B-TP](#) [3SMAJ5947B-TP](#) [3SMBJ5941B-TP](#) [DZ2S240M0L](#) [SMAZ27-](#)
[TP](#) [ZMM5224B-7](#) [RD16UM-T1-A](#) [RD39S-T1-A](#) [RD10S-T1-A](#) [CDZT2R5.6B](#) [1N4762A G](#) [Z1SMA18](#) [JANTX1N4553B](#)