

版本	变更内容	工程确认	日期

- TYPE C USB技术要求:
- 电气性能
    - 1.1 额定电流 3A/5A.
    - 1.2 额定电压: 5V.
    - 1.3 耐压: 500 V(AC) for 1 min.
    - 1.4 接触阻抗: 40mΩ Max.
    - 1.5 可靠性和环境测试后阻抗变化不得超过10mΩ.
  - 机械性能
    - 2.1 插入力: 5-20N. 拔出力: 6-20N.
    - 2.2 寿命测试: 5000/10000cycles Max.
    - 2.3 推力: 50N min.
    - 2.4 剥离强度: 150N min.
    - 2.5 扭曲强度: 0.75Nm
  - 材料要求
    - 4.1 胶芯材料: LCP/PA9T
    - 4.2 外壳材料: SPCC/C2680/SUS304
    - 4.3 端子材料: C2680/C5191/C7025
  - 盐雾要求: 24H/48H
  - 工作温度: -20° C~85° C

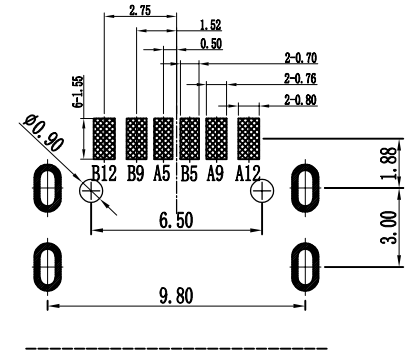
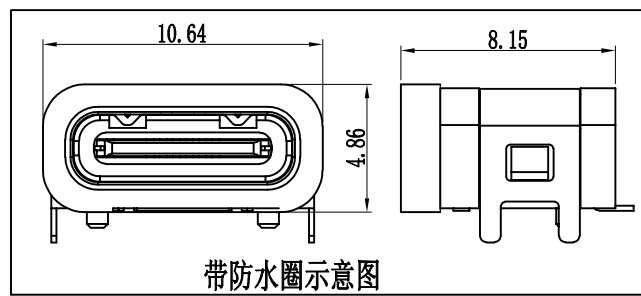
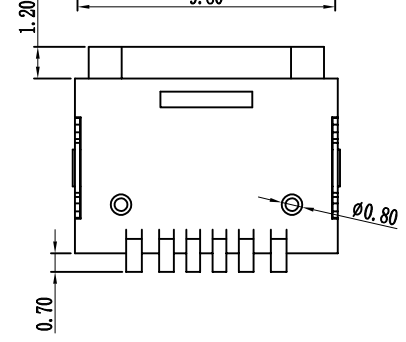
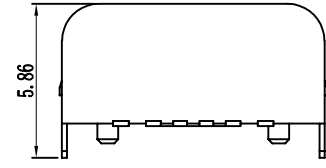
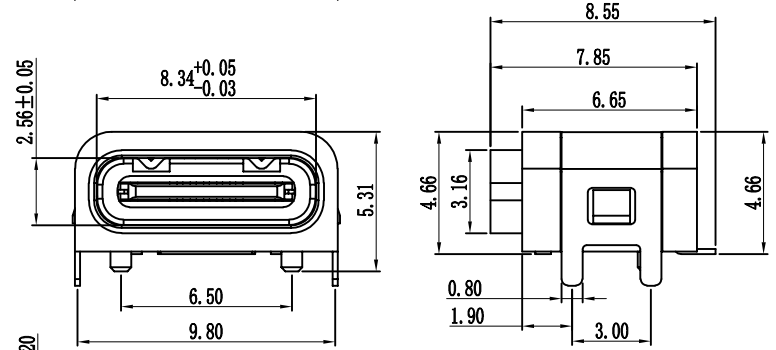
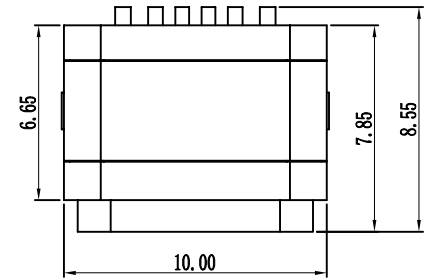
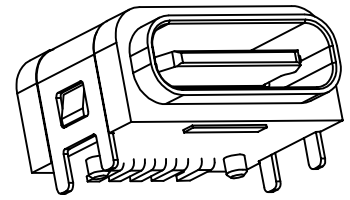

RECOMMENDED P.C.B. LAYOUT  
TOLERANCE UNSPECIFIED ±0.05mm

A5	CC1	B12	GND
A9	VBUS	B9	VBUS
A12	GND	B5	CC2
PIN	SIGNAL NAME	PIN	SIGNAL NAME

<b>深圳市怡远科技有限公司</b> SHENZHEN YIYUAN TECHNOLOGY CO., LTD	
品名 (ITEM NO)	Type C 母座 6P 贴片 防水 长7.85
料号 (PART NO)	YTC-1WP6-2785
图号 (DWG NO)	

页码 (SHEET)	1/1	单位 (UNIT): MM
版本 (REV)	A1	比例 (SCALE)
日期 (DATE)	2021. 10. 12	未注公差 TOLERANCE UNSPECIFIED
设计 (DESIGN)	LUO	X.X ±0.20
审核 (CHECKED)	ROGER LI	X.XX ±0.15
核准 (APPROVED)	ROC ZHAO	X.XXX ±0.10
		X° ±5°
		X.X° ±2°

These drawings and specifications are Shenzhen Yiyuan Technology Co Ltd. The property should not be copied. Without Shenzhen Yiyuan Technology Co. Ltd. Prior written consent to copy or use in any way. Email at info@yiyuanswitches.com

A  
B  
C  
D  
E  
F

A  
E  
C  
D  
E  
F

1 2 3 4 5 6 7 8

## X-ON Electronics

Largest Supplier of Electrical and Electronic Components

*Click to view similar products for [USB Connectors](#) category:*

*Click to view products by [YIYUAN](#) manufacturer:*

Other Similar products are found below :

[950](#) [MUSBD11135](#) [17-200721](#) [217450-1](#) [KMBVX-TH-5S-B30](#) [KUSBX-AS2N-W](#) [KUSBX-SMT2AP1S-W30](#) [935](#) [957](#) [30-498-6](#) [SK-60A-2](#)  
[1734082-1](#) [30-470](#) [30-489](#) [30-541](#) [A-USB A-2P-C](#) [MIKROE-1451](#) [USBFTVSCCG](#) [1-1734084-2](#) [10135326-001LF](#) [4198](#) [USB-A-D-VT](#)  
[USB-A-S-RA-TSMT](#) [1310-1023-02](#) [690-024-633-031](#) [UB-20PMFP-LC7001](#) [17-200011](#) [UB-20AFMM-LL7A01](#) [1040870124](#) [CAP-](#)  
[WCCMLPB1](#) [CAP-WCCMLPC1](#) [2274475-3](#) [UB-20BMFA-SL8001](#) [914-614A2025S10200](#) [USB3FTV7SAGF059](#) [ZX40-B-5S-1500-](#)  
[STDA\(30\)](#) [GSB3116344HR](#) [USB3FTV2SAZNF459](#) [USB3FTV7SAZNF459](#) [U221-041N-1WVS62-F5D](#) [HYCW153-USBD05-500B](#)  
[HYCW219-USBD05-075B](#) [HYCW148-USBD05-117B](#) [HYCW149-USBD05-740B](#) [HYCW204-USBD05-108B](#) [HYCW214-USBA04-113B](#)  
[HYCW213-USBA04-113B](#) [UB-20AMFM-SL7A01](#) [KMMX-BSMT35S-1-B30TR](#) [2345986-1](#)