

6	7	8
版本	变更内容	工程确认 日期

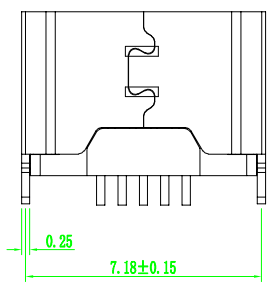

MICRO USB技术要求:

1. 电气性能
 - 1.1. 额定电流: 2A.
 - 1.2. 额定电压: 5V.
 - 1.2. 耐电压: 500 V(AC) for 1 min.
 - 1.3. 接触阻抗: 30 mΩ Max.
可靠性和环境测试后阻抗变化不得超过10mΩ.
 - 1.4. 绝缘阻抗: 100 MΩ min.
2. 机械性能
 - 2.1 插入力: 5~20N. 拔出力: 5~20N.
 - 2.2 寿命测试: 5000cycles.
 - 2.3 推力: 50N min.
 - 2.4 剥离强度: 150N min.
3. 材料要求
 - 3.1 胶芯材料: LCP
 - 3.2 外壳材料: C2680/SPCC
 - 3.3 端子材料: C2680
4. 盐雾要求: 24H
5. 工作温度: -20° C~85° C

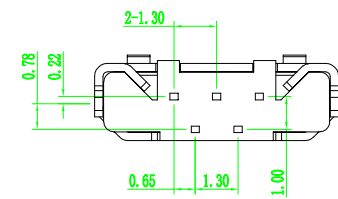
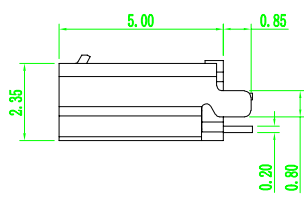
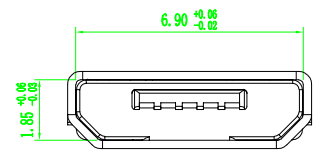
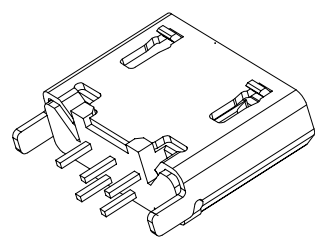
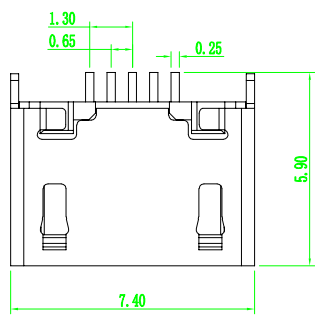
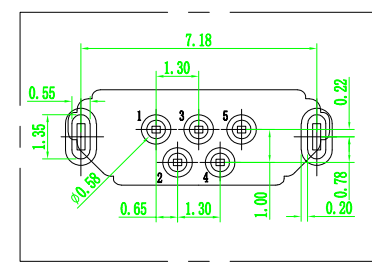

RECOMMENDED P. C. B. LAYOUT

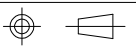
 深圳市怡远科技有限公司 SHENZHEN YIYUAN TECHNOLOGY CO., LTD		页码 (SHEET)	1/1	单位(UNIT): MM
		版本 (REV)	A1	比例(SCALE)
品名 (ITEM NO)	Micro 5P 立式 插件 直边 H=5.0 脚长0.85	日期 (DATE)	2021. 10. 12	 未注公差 TOLERANCE UNSPECIFIED
料号 (PART NO)	YTC-MC-4C50	设计 (DESIGN)	LUO	
图号 (DWG NO)		审核 (CHECKED)	ROGER LI	X.X ±0.20
		核准 (APPROVED)	ROC ZHAO	X.XX ±0.15
				X.XXX ±0.10
				X° ±5°
				X.X° ±2°
These drawings and specifications are Shenzhen Yiyuan Technology Co Ltd.The property should not be copied. Without Shenzhen Yiyuan Technology Co. Ltd.Prior written consent to copy or use in any way				

X-ON Electronics

Largest Supplier of Electrical and Electronic Components

Click to view similar products for [USB Connectors](#) category:

Click to view products by [YIYUAN](#) manufacturer:

Other Similar products are found below :

[950](#) [A-USB B-TOP-C](#) [MUSBA511N5](#) [MUSBC111M5](#) [MUSBD11135](#) [17-200721](#) [217450-1](#) [KMBVX-TH-5S-B30](#) [896-30-004-00-000000](#)
[KUSBX-AS2N-W](#) [KUSBX-SMT2AP1S-W30](#) [935](#) [957](#) [30-498-6](#) [SK-60A-2](#) [1734082-1](#) [30-1574](#) [30-470](#) [30-489](#) [30-541](#) [A-USB A-2P-C](#)
[MIKROE-1451](#) [USBFTV2PEM2G](#) [USBFTVSCCG](#) [4689-1](#) [1-1734084-2](#) [MUSBC11135](#) [USBF21ZNSCC](#) [USBBFTV6ZC](#) [MUSBB151341](#)
[10135326-001LF](#) [M9177/3-1](#) [TJ-105](#) [USB-A-S-F-B-VT](#) [4198](#) [690-024-633-031](#) [UB-20PMFP-LC7001](#) [USBFTVC6MRG](#) [UA-20BMFA-](#)
[SL8001](#) [17-200011](#) [USBFTVC7ZC](#) [UB-20AFMM-LL7A01](#) [USBFTVC2MN](#) [CAP-WCCMLPB1](#) [1310-1031-01](#) [2041386-1](#) [2274475-3](#) [UB-](#)
[20BMFA-SL8001](#) [UB-20PMFP-SC8003](#) [914-614A2025S10200](#)