

# RoHS

CAD GENERATED DRAWING. DON'T CHANGE BY HAND.

REV.	ECN. NO.	APPD.

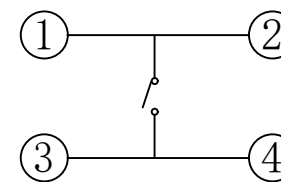
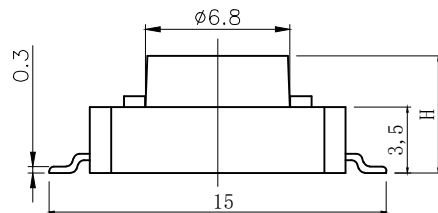
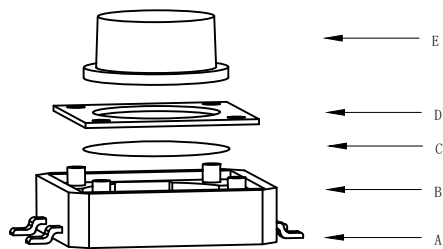

CIRCUIT DIAGRAM

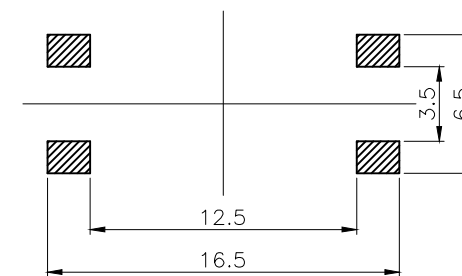
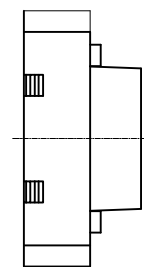
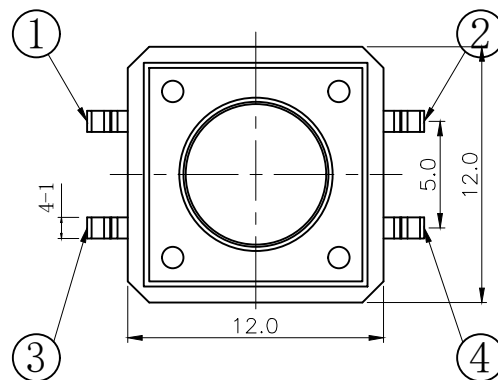
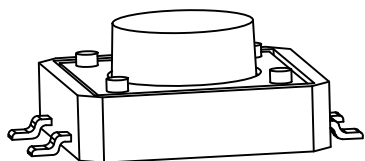

PCB. WELDING DRAWING

### Specification

Operating Life	100,000
Contact rating	50mA@12V DC.
Insulation resistance	1011Ω min.
Contact resistance	100mΩ max. initial.
Dielectric Strength	250 V AC(1mm)
Travel	0.3±0.1mm
Storage Temperature	-30° C to 85° C

Packaging:  
A reel of 500 pieces

### Mechanical

ITEM	DESCRIPTION	MATERIAL	QTY	FINISH/COLOR
E	Button	PPA	1	Black
D	COVER	Brass	1	Cleaning
C	DOME	Stainless Steel	1	Plated Ag
B	HOUSING	PPA	1	Black
A	PIN	PHOSPHOR BRONZE	1	Plated Ag

Type	Operatin Force (gf)	Heiht mm	Button	Leads Shape (G, J, T)	Ground pin (G, L)	Pegs Option (G, L)
YTS1B002	250±50	Q	15.0	B (BLACK)	G	0 (None)
		P	13.0			
		O	12.0			
		N	11.0			
		M	10.0			
		L	9.0			
		K	8.5			
		J	8.0			
		H	7.5			
		G	7.0			
		F	6.5			
		E	6.0			
		D	5.5			
C	5.0					
B	4.5					
A	4.3					

THESE DRAWINGS AND SPECIFICATIONS ARE THE PROPERTY OF YIYUAN TECHNOLOGY CO.,LTD AND SHALL NOT BE REPRODUCED, COPIED OR USED IN ANY MANNER WITHOUT THE PRIOR WRITTEN CONSENT OF YIYUAN TECHNOLOGY CO.,LTD

.X ±0.50	.X° ±2°	UNITS mm
.XX ±0.30	.XX° ±1°	
.XX ±0.10	.XX° ±0.5°	MAT'L
.XXX ±0.05		FINISH
		Q'TY

	<b>深圳市怡远科技有限公司</b> SHENZHEN YIYUAN TECHNOLOGY CO., LTD							
	PART NO. <b>YTS1B002</b>	TITLE: <b>TACTILE SWITCH</b>						
APPD: ROGER	DWG NO.: <b>YTS1B002</b>							
CHKD: ROC								
DR: BILLY WANG 2020/08/21		<table border="1"> <tr> <th>SCALE</th> <th>SHEET</th> <th>REV.</th> </tr> <tr> <td>1/1</td> <td>1/1</td> <td>A1</td> </tr> </table>	SCALE	SHEET	REV.	1/1	1/1	A1
SCALE	SHEET	REV.						
1/1	1/1	A1						

## X-ON Electronics

Largest Supplier of Electrical and Electronic Components

*Click to view similar products for [Tactile Switches](#) category:*

*Click to view products by [YIYUAN](#) manufacturer:*

Other Similar products are found below :

[5GTH92001](#) [5GTH9202242](#) [6407-250V-25273P](#) [ADTSA62NV](#) [ADTSA62RV](#) [B3F-3123](#) [1977177-8](#) [1977266-1](#) [ADTSA63NV](#)  
[ADTSM21NSVTR](#) [ADTSM25RVTR](#) [ADTSM32NVTR](#) [ADTSMW64RV](#) [FSMRA4JHA04](#) [GS4.70F300QP](#) [KSC241J SP DELTA LFS](#)  
[3FTL600RAS](#) [3FTL640RAS](#) [Y96K132V0FPLFS](#) [5GTH9658222](#) [ADTSM31NVTR](#) [2-1977120-7](#) [TSJW-5.2-260-TR](#) [KMT011MNGJLHS](#)  
[B3WN6002S](#) [70-201.0](#) [ADTSG648NV](#) [ADTSM62KSVTR](#) [ADTSM648NV](#) [95C06E3RAT](#) [5GTH96561](#) [3ATH9Q](#) [FSMRA8JHA04](#)  
[HARS0073](#) [Y33R411N9FPLFT](#) [Y31C01402FPLFS](#) [PTS645SK50SMTR92](#) [ADTSM32NVB](#) [KMS233GPWTLFG](#) [Y78B64124FP](#)  
[Y96D113G0FP LFS](#) [Y33A812C5FP LFT](#) [Y56B2D120FP LFS](#) [PTS645 DVM83-BN125-2 LFS](#) [B3W 1000G](#) [KSC621G OL LFS](#) [B3F 1002C](#)  
[B3F 0047H](#) [B3F 1000G](#) [B3W 1002C](#)