

RoHS

CAD GENERATED DRAWING. DON'T CHANGE BY HAND.

REV.	ECN. NO.	APPD.

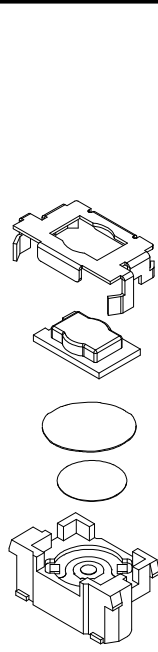

← 6
← 5
← 4
← 3
← 2
← 1

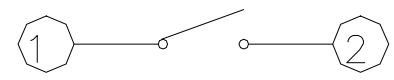
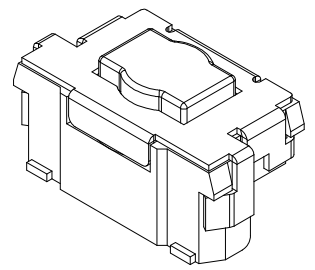
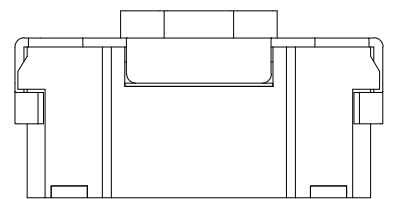

CIRCUIT DIAGRAM

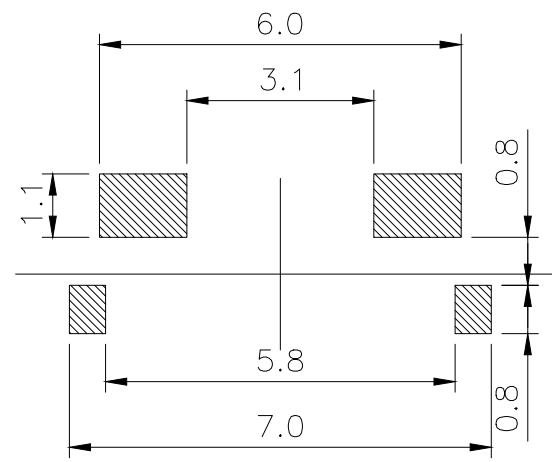
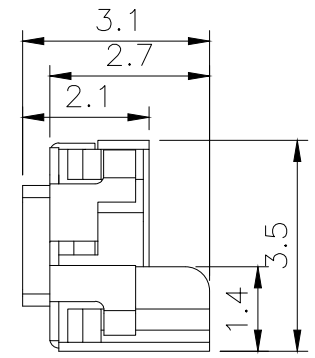
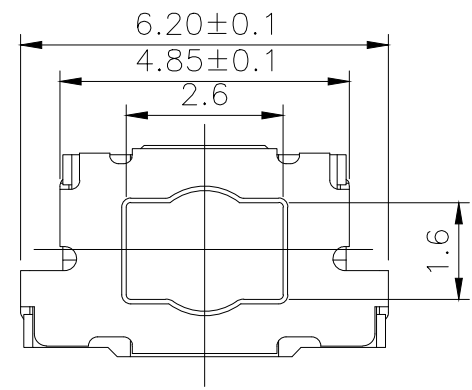

PCB. WELDING DRAWING

Specification

Operating Life	100,000
Contact rating	50mA@12V DC.
Insulation resistance	1011Ω min.
Contact resistance	100mΩ max. initial.
Dielectric Strength	250 V AC(1mm)
Travel	0.2±0.1mm
Storage Temperature	- 30° C to 80° C

Packaging:
a reel of 2,000 pieces

E	Button	LCP	1	White
D	COVER	Phosphor copper	1	Silver
C	DOME	Stainless Steel	1	Plated Ag
B	HOUSING	LCP	1	Black
A	Cards	Phosphor copper	1	Plated Ag
ITEM	DESCRIPTION	MATERIAL	QTY	FINISH/COLOR

Mechanical

P/N	Operating Force (gf)	Height mm	Button	Leads Shape (G, J, T)	Ground pin (0, 1)	Pegs Option (0, 1)
YTS1C017	2	250±50	B	3.5	0 (None)	0 (none)
	1	180±50	A	3.1	0 (None)	0 (none)

X. ±0.50	X.° ± 2°	UNITS mm
.X ±0.30	.X° ± 1°	
.XX ±0.10	.XX° ± 0.5°	MAT'L
.XXX ± 0.05		
THESE DRAWINGS AND SPECIFICATIONS ARE THE PROPERTY OF YIYUAN TECHNOLOGY CO.,LTD AND SHALL NOT BE REPRODUCED, COPIED OR USED IN ANY MANNER WITHOUT THE PRIOR WRITTEN CONSENT OF YIYUAN TECHNOLOGY CO.,LTD		FINISH
		Q' TY



深圳市怡远科技有限公司
SHENZHEN YIYUAN TECHNOLOGY CO., LTD

PART NO. YTS1C017	TITLE: TACTILE SWITCH
APPD: ROGER	DWG NO. : YTS1C017
CHKD: ROC	
DR: BILLY WANG 2020/08/21	

	SCALE	SHEET	REV.
	1/1	1/1	A1

X-ON Electronics

Largest Supplier of Electrical and Electronic Components

Click to view similar products for [Tactile Switches](#) category:

Click to view products by [YIYUAN](#) manufacturer:

Other Similar products are found below :

[5GTH92001](#) [5GTH9202242](#) [ADTSA62NV](#) [ADTSA62RV](#) [B3F-3123](#) [1977177-8](#) [1977266-1](#) [ADTSA63NV](#) [ADTSM21NSVTR](#)
[ADTSM25RVTR](#) [ADTSM32NVTR](#) [ADTSMW64RV](#) [FSMRA4JHA04](#) [GS4.70F300QP](#) [3ESH9R](#) [KSC241J SP DELTA LFS](#) [3FTL600RAS](#)
[3FTL640RAS](#) [Y96K132V0FPLFS](#) [5GSH92001](#) [5GTH9658222](#) [ADTSM31NVTR](#) [2-1977120-7](#) [TSJW-5.2-260-TR](#) [KMT011MNGJLHS](#)
[ADTSG648NV](#) [ADTSM62KSVTR](#) [ADTSM648NV](#) [95C06E3RAT](#) [3ATH9Q](#) [FSM4JSMLXTR](#) [FSM4JSMXL](#) [FSMRA8JHA04](#) [HARS0073](#)
[Y97HS12A5RAFP](#) [Y97BT23B2HAFP](#) [Y33R411N9FPLFT](#) [Y31C01402FPLFS](#) [PTS645SK50SMTR92](#) [ADTSM32NVB](#) [KMS233GPWTLFG](#)
[Y78B42324FP](#) [Y33R21116FPLFT](#) [Y31B43131FPLFG](#) [Y78B64124FP](#) [Y71243251FP](#) [Y33R31119FPLFT](#) [Y97HS12A5TAFP](#)
[PTS638SK25SMTR2LFS](#) [Y97LT25BADBFP](#)