

RoHS

CAD GENERATED DRAWING. DON'T CHANGE BY HAND.

REV.	ECN. NO.	APPD.

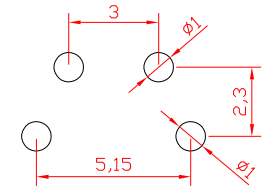
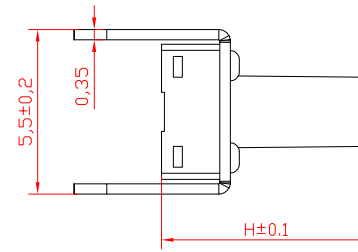
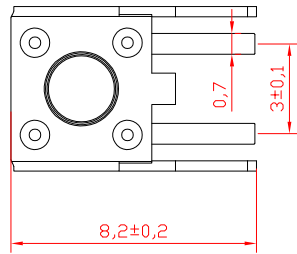
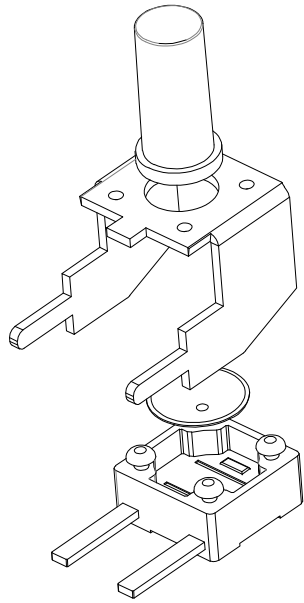

PCB. WELDING DRAWING

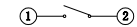
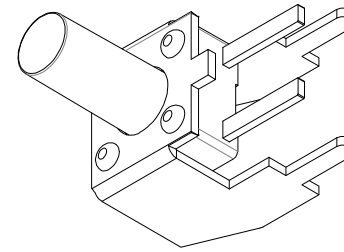
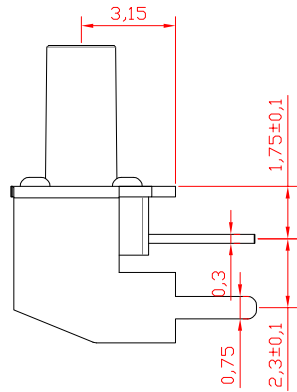

CIRCUIT DIAGRAM

Specification

Operating Life	100,000
Contact rating	50mA@12V DC.
Insulation resistance	≥100 Ω
Contact resistance	≤50m Ω
Dielectric Strength	250 V 50HZ(1mm)
Travel	0.2±0.1mm
Storage Temperature	-30° C to 85° C

Mechanical

ITEM	DESCRIPTION	MATERIAL	QTY	FINISH/COLOR
E	Pin.contact	brass	1	Silver plated
D	base	PPA	1	Temperature 260t (black)
C	reed	Stainless steel	1	Silver coated
B	stents	Cold rolled steel	1	Tin plating
A	button	PPA	1	Temperature 260t (black)

Type	Operating Force(gf)	Height mm	Button	Leads Shape(G,J,T)	Ground pin (0,1)	Pegs Option (0,1)
YTS1H015	250±40	S	xx	T	1	0 (None)
		R	10.5			
		Q	10			
		P	9.5			
		D	9.0			
		N	8.5			
		M	8.0			
		L	7.5			
		K	7.0			
		J	6.5			
		H	6.0			
		G	5.5			
		F	5.0			
		E	4.8			
D	4.5					
C	4.3					
B	3.8					
A	3.5					

.X ±0.50	.X° ±2°	UNITS mm
.X ±0.30	.X° ±1°	
.XX ±0.10	.XX° ±0.5°	MAT'L
.XXX ±0.05		FINISH
THESE DRAWINGS AND SPECIFICATIONS ARE THE PROPERTY OF YIYUAN TECHNOLOGY CO.,LTD AND SHALL NOT BE REPRODUCED, COPIED OR USED IN ANY MANNER WITHOUT THE PRIOR WRITTEN CONSENT OF YIYUAN TECHNOLOGY CO.,LTD		Q'TY



深圳市怡远科技有限公司
SHENZHEN YIYUAN TECHNOLOGY CO.,LTD

PART NO. YTS1H025	TITLE: TACTILE SWITCH
APPD: RDGER	DWG NO.: YTS1H025
CHKD: RDC	
DR: BILLY WANG 2020/08/21	

SCALE	SHEET	REV.
1/1	1/1	A1

X-ON Electronics

Largest Supplier of Electrical and Electronic Components

Click to view similar products for [Tactile Switches](#) category:

Click to view products by [YIYUAN](#) manufacturer:

Other Similar products are found below :

[5GTH92001](#) [5GTH9202242](#) [6407-250V-25273P](#) [ADTSA62NV](#) [ADTSA62RV](#) [B3F-3123](#) [1977177-8](#) [1977266-1](#) [ADTSA63NV](#)
[ADTSM21NSVTR](#) [ADTSM25RVTR](#) [ADTSM32NVTR](#) [ADTSMW64RV](#) [FSMRA4JHA04](#) [GS4.70F300QP](#) [3ESH9R](#) [KSC241J](#) [SP DELTA](#)
[LFS](#) [3FTL600RAS](#) [3FTL640RAS](#) [Y96K132V0FPLFS](#) [5GTH9658222](#) [ADTSM31NVTR](#) [2-1977120-7](#) [TSJW-5.2-260-TR](#)
[KMT011MNGJLHS](#) [70-201.0](#) [ADTSG648NV](#) [ADTSM62KSVTR](#) [ADTSM648NV](#) [95C06E3RAT](#) [5GTH96561](#) [3ATH9Q](#) [FSM4JSMLXTR](#)
[FSM4JSMXL](#) [FSMRA8JHA04](#) [HARS0073](#) [Y97HS12A5RAFP](#) [Y97BT23B2HAFP](#) [Y33R411N9FPLFT](#) [Y31C01402FPLFS](#)
[PTS645SK50SMTR92](#) [ADTSM32NVB](#) [KMS233GPWTLFG](#) [Y78B42324FP](#) [Y33R21116FPLFT](#) [Y31B43131FPLFG](#) [Y78B64124FP](#)
[Y71243251FP](#) [Y33R31119FPLFT](#) [Y97HS12A5TAFP](#)