

RoHS

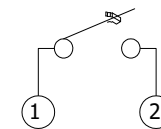

CAD GENERATED DRAWING. DON'T CHANGE BY HAND.

REV. ECN. NO. APPD.

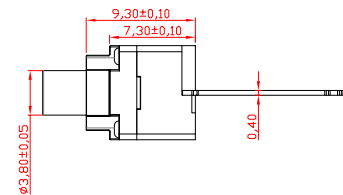
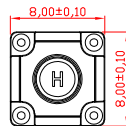
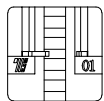
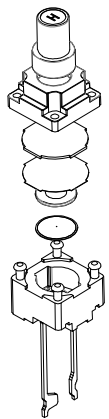

CIRCUIT DIAGRAM

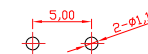
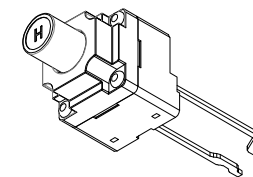
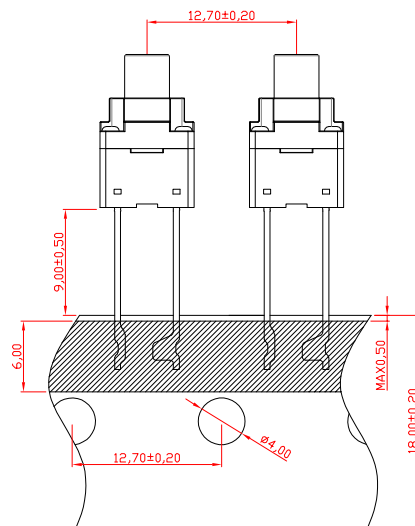
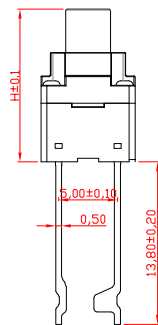

PCB. WELDING DRAWING

Specification

Operating Life	100,000
Contact rating	50mA@12V DC.
Insulation resistance	≥100MΩ
Contact resistance	≤100mΩ
Dielectric Strength	250 V 50HZ(1mm)
Travel	0.3+0.2/-0.1mm
Storage Temperature	-30° C to 80° C

Waterproof: IPX7

ITEM	DESCRIPTION	MATERIAL	QTY	FINISH/CDLDR
E	STEM	LCP	1	Molze
D	COVER	Phosphor copper	1	Silver
C	IDME	Stainless Steel	1	Plated Ag
B	HOUSING	PPA	1	Black
A	PIN	Brass	1	Plated Ag

Mechanical

Type	Operating Force(gf)	Height mm	Button Shape	Leads Shape(G,J,T)	Ground pin (0,1)	Pegs Option (0,1)
YTS1K005	2	15.00	B (BLACK)	T	0 (None)	0 (None)
	250±50	13.00				
	160±50	12.85				

THESE DRAWINGS AND SPECIFICATIONS ARE THE PROPERTY OF YIYUAN TECHNOLOGY CO.,LTD AND SHALL NOT BE REPRODUCED, COPIED OR USED IN ANY MANNER WITHOUT THE PRIOR WRITTEN CONSENT OF YIYUAN TECHNOLOGY CO.,LTD

X. ±0.50	X.* ± 2°	UNITS mm
.X ±0.30	.X* ± 1°	
.XX ±0.10	.XX* ± 0.5°	MAT'L
.XXX ± 0.05		FINISH
		Q'TY



深圳市怡远科技有限公司
SHENZHEN YIYUAN TECHNOLOGY CO.,LTD

PART NO. YTS1K005	TITLE: TACTILE SWITCH 8x8 WATERPROOF
APPD: ROGER	DWG NO.: YTS1K005
CHKD: RDC	SCALE SHEET REV. 1/1 1/1 A1
DR: BILLY WANG 2020/08/21	

Packaging:
Reel of 2,000 pieces.

X-ON Electronics

Largest Supplier of Electrical and Electronic Components

Click to view similar products for [Tactile Switches](#) category:

Click to view products by [YIYUAN](#) manufacturer:

Other Similar products are found below :

[5GTH92001](#) [5GTH9202242](#) [ADTSA62NV](#) [ADTSA62RV](#) [B3F-3123](#) [1977177-8](#) [1977266-1](#) [ADTSA63NV](#) [ADTSM21NSVTR](#)
[ADTSM25RVTR](#) [ADTSM32NVTR](#) [ADTSMW64RV](#) [FSMRA4JHA04](#) [GS4.70F300QP](#) [3ESH9R](#) [KSC241J SP DELTA LFS](#) [3FTL600RAS](#)
[3FTL640RAS](#) [Y96K132V0FPLFS](#) [5GSH92001](#) [5GTH9658222](#) [ADTSM31NVTR](#) [2-1977120-7](#) [TSJW-5.2-260-TR](#) [KMT011MNGJLHS](#)
[ADTSG648NV](#) [ADTSM62KSVTR](#) [ADTSM648NV](#) [95C06E3RAT](#) [3ATH9Q](#) [FSM4JSMLXTR](#) [FSM4JSMXL](#) [FSMRA8JHA04](#) [HARS0073](#)
[Y97HS12A5RAFP](#) [Y97BT23B2HAFP](#) [Y33R411N9FPLFT](#) [Y31C01402FPLFS](#) [PTS645SK50SMTR92](#) [ADTSM32NVB](#) [KMS233GPWTLFG](#)
[Y78B42324FP](#) [Y33R21116FPLFT](#) [Y31B43131FPLFG](#) [Y78B64124FP](#) [Y71243251FP](#) [Y33R31119FPLFT](#) [Y97HS12A5TAFP](#)
[PTS638SK25SMTR2LFS](#) [Y97LT25BADBFP](#)