

RoHS

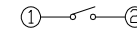

CAD GENERATED DRAWING. DON'T CHANGE BY HAND.

REV.	ECN. NO.	APPD.

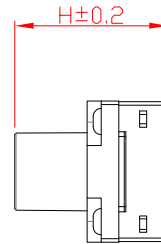
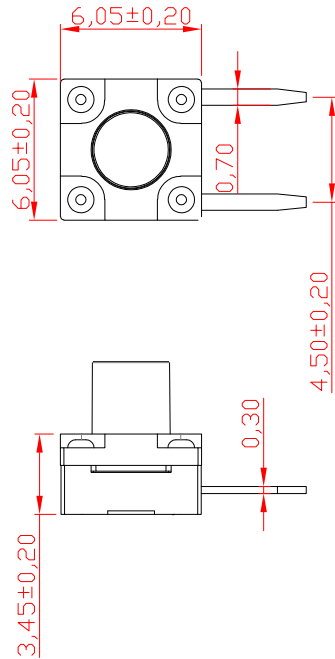
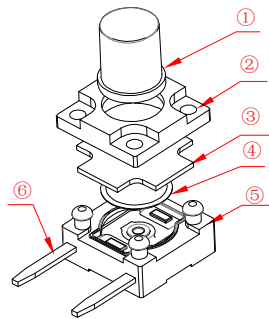

CIRCUIT DIAGRAM

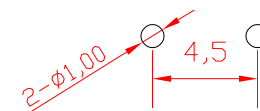
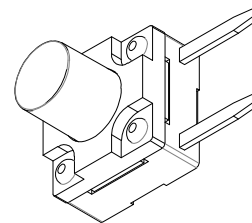

PCB. WELDING DRAWING

Specification

Operating Life	100,000
Contact rating	50mA@12V DC.
Insulation resistance	≥100MΩ
Contact resistance	≤50mΩ
Dielectric Strength	250 V 50HZ(1mm)
Travel	0.25mm
Storage Temperature	- 30° C to 80° C

Mechanical

ITEM	DESCRIPTION	MATERIAL	QTY	FINISH/CDLDR
E	STEM	LCP	1	Molze
D	COVER	Phosphor copper	1	Silver
C	DDME	Stainless Steel	1	Plated Ag
B	HOUSING	PPA	1	Black
A	PIN	Brass	1	Plated Ag

Type	Operating Force(gf)	Height mm	Button	Leads Shape (G,I,T)	Ground pin Option (0,1)	Pegs Option (0,1)
2	250±50	M	9.5	B	T	0
		L	9.0			
		K	8.5			
		J	8.0			
		H	7.5			
		G	7.0			
1	160±50	F	6.5	T	0	0
		E	6.0			
		D	5.5			
		C	5.0			
		B	4.5			
		A	4.3			

.X ±0.50	.X° ± 2°	UNITS mm
.X ±0.30	.X° ± 1°	
.XX ±0.10	.XX° ± 0.5°	MAT'L
.XXX ± 0.05		FINISH
		Q'TY

THESE DRAWINGS AND SPECIFICATIONS ARE THE PROPERTY OF YIYUAN TECHNOLOGY CO.,LTD AND SHALL NOT BE REPRODUCED, COPIED OR USED IN ANY MANNER WITHOUT THE PRIOR WRITTEN CONSENT OF YIYUAN TECHNOLOGY CO.,LTD



深圳市怡远科技有限公司

SHENZHEN YIYUAN TECHNOLOGY CO.,LTD

PART NO. YTS1K016	TITLE: TACTILE SWITCH
APPD: ROGER	DWG NO.: YTS1K016
CHKD: RDC	
DR: BILLY WANG 2020/08/21	

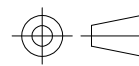

SCALE	SHEET	REV.
1/1	1/1	A1

## X-ON Electronics

Largest Supplier of Electrical and Electronic Components

*Click to view similar products for [Tactile Switches](#) category:*

*Click to view products by [YIYUAN](#) manufacturer:*

Other Similar products are found below :

[5GTH92001](#) [5GTH9202242](#) [ADTSA62NV](#) [ADTSA62RV](#) [B3F-3123](#) [1977177-8](#) [1977266-1](#) [ADTSA63NV](#) [ADTSM21NSVTR](#)  
[ADTSM25RVTR](#) [ADTSM32NVTR](#) [ADTSMW64RV](#) [FSMRA4JHA04](#) [GS4.70F300QP](#) [3ESH9R](#) [KSC241J](#) [SP DELTA LFS](#) [3FTL600RAS](#)  
[3FTL640RAS](#) [Y96K132V0FPLFS](#) [5GSH92001](#) [5GTH9658222](#) [ADTSM31NVTR](#) [2-1977120-7](#) [TSJW-5.2-260-TR](#) [KMT011MNGJLHS](#)  
[ADTSG648NV](#) [ADTSM62KSVTR](#) [ADTSM648NV](#) [95C06E3RAT](#) [3ATH9Q](#) [FSM4JSMLXTR](#) [FSM4JSMXL](#) [FSMRA8JHA04](#) [HARS0073](#)  
[Y97HS12A5RAFP](#) [Y97BT23B2HAFP](#) [Y33R411N9FPLFT](#) [Y31C01402FPLFS](#) [PTS645SK50SMTR92](#) [ADTSM32NVB](#) [KMS233GPWTLFG](#)  
[Y78B42324FP](#) [Y33R21116FPLFT](#) [Y31B43131FPLFG](#) [Y78B64124FP](#) [Y71243251FP](#) [Y33R31119FPLFT](#) [Y97HS12A5TAFP](#)  
[PTS638SK25SMTR2LFS](#) [Y97LT25BADBFP](#)