

REV.	ECN. NO.	APPD.

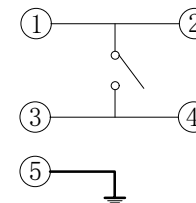

CIRCUIT DIAGRAM

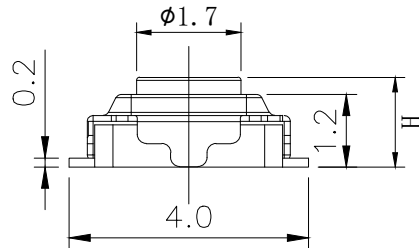
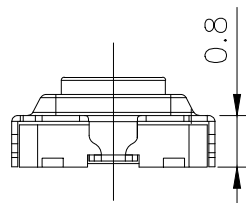
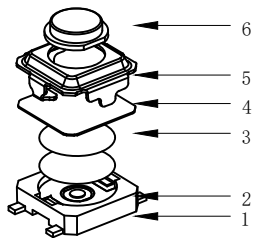
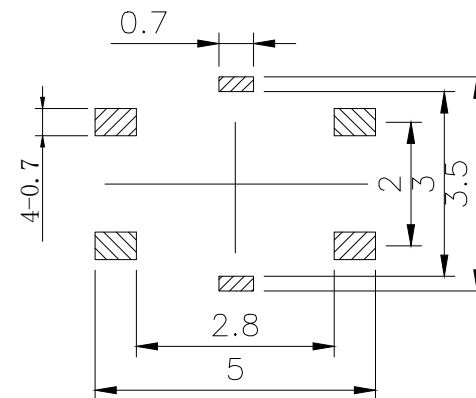
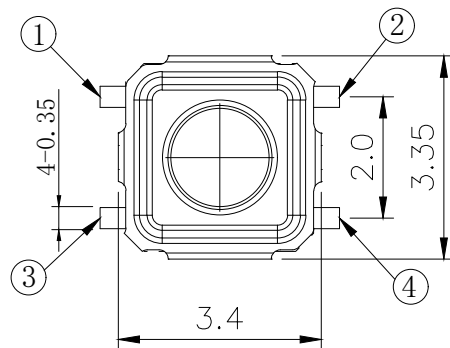
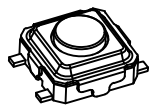

PCB. WELDING DRAWING

Specification

Operating Life	100,000
Contact rating	50mA@12V DC.
Insulation resistance	1011 Ω min.
Contact resistance	100mΩ max. initial.
Dielectric Strength	250 V AC(1mm)
Travel	0.25±0.15mm
Storage Temperature	-30° C to 80° C

Mechanical

ITEM	DESCRIPTION	MATERIAL	QTY	FINISH/COLOR
E	Button	LCP	1	Black
D	COVER	Stainless Steel	1	Cleaning
C	DOME	Stainless Steel	1	Plated Ag
B	HOUSING	PPA	1	Black
A	PIN	PHOSPHOR BRONZE	1	Plated Ag

Type	Operating Force (gf)	Height (mm)	Button	Leads Shape (G, J, T)	Ground pin (0, 1)	Pegs Option (0, 1)
YTS1T007	3	320±50	E	2.5	B (Black) W (White)	G
	2	250±50	D	2.0		
			C	1.8		
			B	1.7		
1	160±50	A	1.5	1 (Ground pin) 0 (None)		

X.	±0.50	X.°	±2°
.X	±0.30	.X°	±1°
.XX	±0.10	.XX°	±0.5°
.XXX	±0.05		

THESE DRAWINGS AND SPECIFICATIONS ARE THE PROPERTY OF YIYUAN TECHNOLOGY CO.,LTD AND SHALL NOT BE REPRODUCED, COPIED OR USED IN ANY MANNER WITHOUT THE PRIOR WRITTEN CONSENT OF YIYUAN TECHNOLOGY CO.,LTD

UNITS	mm
MAT'L	/
FINISH	/
Q'TY	/



深圳市怡远科技有限公司
SHENZHEN YIYUAN TECHNOLOGY CO., LTD

PART NO.	YTS1T007
APPD:	ROGER
CHKD:	ROC
DR:	BILLY WANG 2020/08/21

TITLE:	TACTILE SWITCH	
DWG NO.:	YTS1T007	
SCALE	SHEET	REV.
1/1	1/1	A1

Packaging:
Reel of 4,000 pieces.

X-ON Electronics

Largest Supplier of Electrical and Electronic Components

Click to view similar products for [Tactile Switches](#) category:

Click to view products by [YIYUAN](#) manufacturer:

Other Similar products are found below :

[5GTH92001](#) [5GTH9202242](#) [ADTSA62NV](#) [ADTSA62RV](#) [B3F-3123](#) [1977177-8](#) [1977266-1](#) [ADTSA63NV](#) [ADTSM21NSVTR](#)
[ADTSM25RVTR](#) [ADTSM32NVTR](#) [ADTSMW64RV](#) [FSMRA4JHA04](#) [GS4.70F300QP](#) [3ESH9R](#) [KSC241J](#) [SP DELTA LFS](#) [3FTL600RAS](#)
[3FTL640RAS](#) [Y96K132V0FPLFS](#) [5GSH92001](#) [5GTH9658222](#) [ADTSM31NVTR](#) [2-1977120-7](#) [TSJW-5.2-260-TR](#) [KMT011MNGJLHS](#)
[ADTSG648NV](#) [ADTSM62KSVTR](#) [ADTSM648NV](#) [95C06E3RAT](#) [3ATH9Q](#) [FSM4JSMLXTR](#) [FSM4JSMXL](#) [FSMRA8JHA04](#) [HARS0073](#)
[Y97HS12A5RAFP](#) [Y97BT23B2HAFP](#) [Y33R411N9FPLFT](#) [Y31C01402FPLFS](#) [PTS645SK50SMTR92](#) [ADTSM32NVB](#) [KMS233GPWTLFG](#)
[Y78B42324FP](#) [Y33R21116FPLFT](#) [Y31B43131FPLFG](#) [Y78B64124FP](#) [Y71243251FP](#) [Y33R31119FPLFT](#) [Y97HS12A5TAFP](#)
[PTS638SK25SMTR2LFS](#) [Y97LT25BADBFP](#)