

REV.	ECN. NO.	APPD.

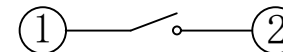

CIRCUIT DIAGRAM

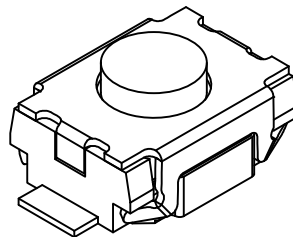
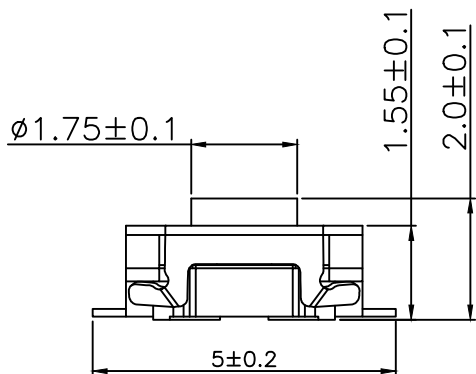
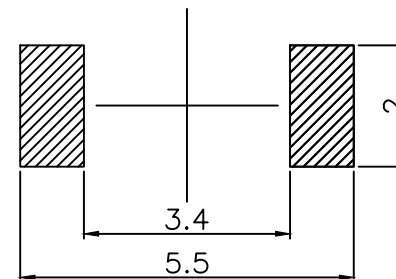
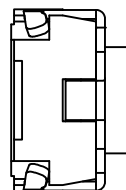
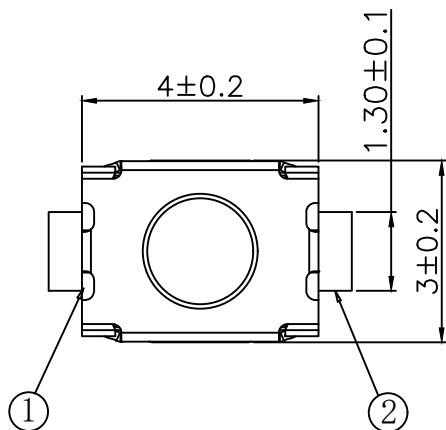

PCB. WELDING DRAWING

Specification

Operating Life	100,000
Contact rating	50mA@12V DC.
Insulation resistance	1011Ω min.
Contact resistance	100mΩ max. initial.
Dielectric Strength	250 V AC(1mm)
Travel	0.2±0.15mm
Storage Temperature	-30° C to 80° C

Packaging:
Reel of 4,000 pieces.

E	Button	LCP/Silica	1	Black/Blue
D	COVER	Stainless Steel	1	Cleaning
C	DOME	Stainless Steel	1	Plated Ag
B	HOUSING	PPA	1	Black
A	PIN	PHOSPHOR BRONZE	1	Plated Ag
ITEM	DESCRIPTION	MATERIAL	QTY	FINISH/COLOR

Mechanical

Type	Operatin Force(gf)	Height mm	Button	Leads Shape(G, J, T)	Ground pin (0, 1)	Pegs Option(0, 1)		
YTS1T009	2	250±50	B	2.0	U(Blue) B(Black)	G	0 (None)	0 (None)
	1	180±50	A	1.8				

X. ±0.50	X.° ±2°	UNITS mm
.X ±0.30	.X° ±1°	
.XX ±0.10	.XX° ±0.5°	MAT'L
.XXX ±0.05		FINISH
THESE DRAWINGS AND SPECIFICATIONS ARE THE PROPERTY OF YIYUAN TECHNOLOGY CO.,LTD AND SHALL NOT BE REPRODUCED OR USED IN ANY MANNER WITHOUT THE PRIOR WRITTEN CONSENT OF YIYUAN TECHNOLOGY CO.,LTD		Q' TY



深圳市怡远科技有限公司
SHENZHEN YIYUAN TECHNOLOGY CO., LTD

PART NO.
YTS1T009

TITLE:
TACTILE SWITCH

APPD: ROGER

DWG NO. :
YTS1T009

CHKD: ROC

DR: BILLY WANG 2020/08/21

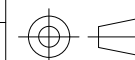

SCALE	SHEET	REV.
1/1	1/1	A1

X-ON Electronics

Largest Supplier of Electrical and Electronic Components

Click to view similar products for [Tactile Switches](#) category:

Click to view products by [YIYUAN](#) manufacturer:

Other Similar products are found below :

[5GTH92001](#) [5GTH9202242](#) [6407-250V-25273P](#) [ADTSA62NV](#) [ADTSA62RV](#) [B3F-3123](#) [1977177-8](#) [1977266-1](#) [ADTSA63NV](#)
[ADTSM21NSVTR](#) [ADTSM25RVTR](#) [ADTSM32NVTR](#) [ADTSMW64RV](#) [FSMRA4JHA04](#) [GS4.70F300QP](#) [KSC241J SP DELTA LFS](#)
[3FTL600RAS](#) [3FTL640RAS](#) [Y96K132V0FPLFS](#) [5GTH9658222](#) [6407-250V-25343P](#) [ADTSM31NVTR](#) [EVQ-P1D05K](#) [2-1977120-7](#) [TSJW-](#)
[5.2-260-TR](#) [KMT011MNGJLHS](#) [B3WN6002S](#) [70-201.0](#) [ADTSG648NV](#) [ADTSM62KSVTR](#) [ADTSM648NV](#) [95C06E3RAT](#) [5GTH96561](#)
[3ATH9Q](#) [FSMRA8JHA04](#) [HARS0073](#) [Y97HS12A5RAFP](#) [Y97BT23B2HAFP](#) [Y33R411N9FPLFT](#) [Y31C01402FPLFS](#)
[PTS645SK50SMTR92](#) [ADTSM32NVB](#) [KMS233GPWTLFG](#) [Y78B64124FP](#) [PTS638SK25SMTR2LFS](#) [Y96D113G0FP LFS](#) [Y33A812C5FP](#)
[LFT](#) [Y56B2D120FP LFS](#) [PTS645 DVM83-BN125-2 LFS](#) [B3W 1000G](#)