

RoHS

CAD GENERATED DRAWING. DON'T CHANGE BY HAND.

REV.	ECN. NO.	APPD.

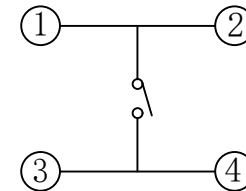
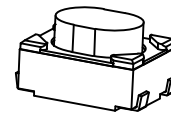
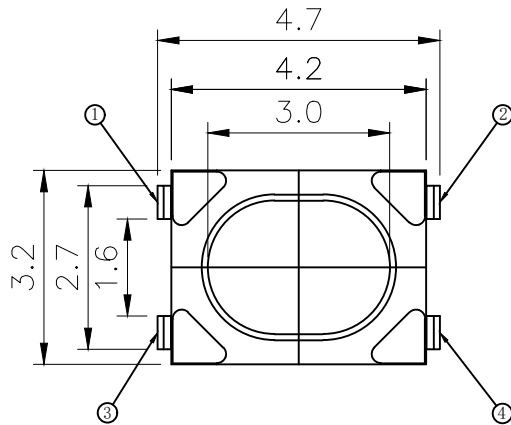
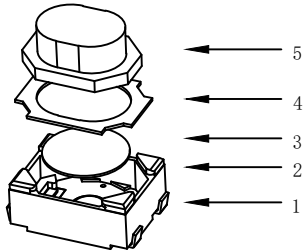

CIRCUIT DIAGRAM

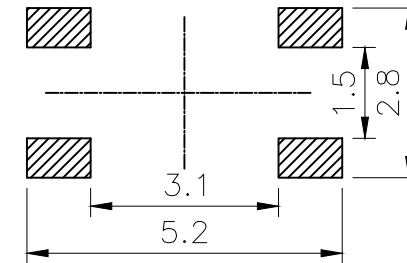
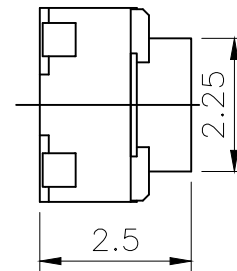

PCB. WELDING DRAWING

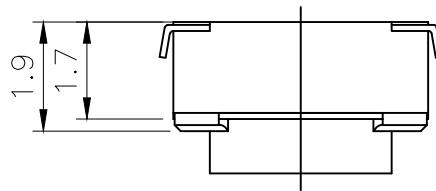

Specification

Operating Life	100,000
Contact rating	50mA@12V DC.
Insulation resistance	1011 Ω min.
Contact resistance	100mΩ max. initial.
Dielectric Strength	250 V AC(1mm)
Travel	0.35±0.15mm
Storage Temperature	-30° C to 85° C

ITEM	DESCRIPTION	MATERIAL	QTY	FINISH/COLOR
E	STEM	PPA	1	White/Black
D	COVER	Stainless Steel	1	Clean
C	DOME	Stainless Steel	1	Plated Ag
B	HOUSING	LCP	1	White
A	PIN	Brass	1	Plated Ag

Mechanical

PN	Operatin g Force (gf)	Heiht mm
YTS1T0161AWJ00	160±50	2.5
YTS1T0162AWJ00	250±50	2.5
YTS1T0163ABJ00	400±50	2.5

.X	±0.50	X.°	±2°	UNITS mm
.XX	±0.30	.X°	±1°	
.XX	±0.10	.XX°	±0.5°	MAT' L /
.XXX	±0.05			
THESE DRAWINGS AND SPECIFICATIONS ARE THE PROPERTY OF YIYUAN TECHNOLOGY CO.,LTD AND SHALL NOT BE REPRODUCED, COPIED OR USED IN ANY MANNER WITHOUT THE PRIOR WRITTEN CONSENT OF YIYUAN TECHNOLOGY CO.,LTD				FINISH /



深圳市怡远科技有限公司
SHENZHEN YIYUAN TECHNOLOGY CO., LTD

Packaging:
Reel of 2,000 pieces.

PART NO.
YTS1T016

TITLE:
TACTILE SWITCH

APPD: ROGER

DWG NO.:
YTS1T016

CHKD: ROC

DR: BILLY WANG 2020/08/21



SCALE	SHEET	REV.
1/1	1/1	A1

X-ON Electronics

Largest Supplier of Electrical and Electronic Components

Click to view similar products for [Tactile Switches](#) category:

Click to view products by [YIYUAN](#) manufacturer:

Other Similar products are found below :

[5GTH92001](#) [5GTH9202242](#) [ADTSA62NV](#) [ADTSA62RV](#) [B3F-3123](#) [1977177-8](#) [1977266-1](#) [ADTSA63NV](#) [ADTSM21NSVTR](#)
[ADTSM25RVTR](#) [ADTSM32NVTR](#) [ADTSMW64RV](#) [FSMRA4JHA04](#) [GS4.70F300QP](#) [3ESH9R](#) [KSC241J](#) [SP DELTA LFS](#) [3FTL600RAS](#)
[3FTL640RAS](#) [Y96K132V0FPLFS](#) [5GSH92001](#) [5GTH9658222](#) [ADTSM31NVTR](#) [2-1977120-7](#) [TSJW-5.2-260-TR](#) [KMT011MNGJLHS](#)
[ADTSG648NV](#) [ADTSM62KSVTR](#) [ADTSM648NV](#) [95C06E3RAT](#) [3ATH9Q](#) [FSM4JSMLXTR](#) [FSM4JSMXL](#) [FSMRA8JHA04](#) [HARS0073](#)
[Y97HS12A5RAFP](#) [Y97BT23B2HAFP](#) [Y33R411N9FPLFT](#) [Y31C01402FPLFS](#) [PTS645SK50SMTR92](#) [ADTSM32NVB](#) [KMS233GPWTLFG](#)
[Y78B42324FP](#) [Y33R21116FPLFT](#) [Y31B43131FPLFG](#) [Y78B64124FP](#) [Y71243251FP](#) [Y33R31119FPLFT](#) [Y97HS12A5TAFP](#)
[PTS638SK25SMTR2LFS](#) [Y97LT25BADBFP](#)