

RoHS

CAD GENERATED DRAWING. DON'T CHANGE BY HAND

REV.	ECN. NO.	APPD.

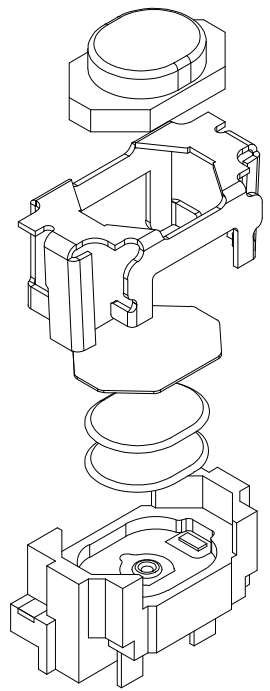

F  
E  
D  
C  
B  
A

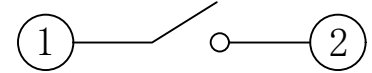
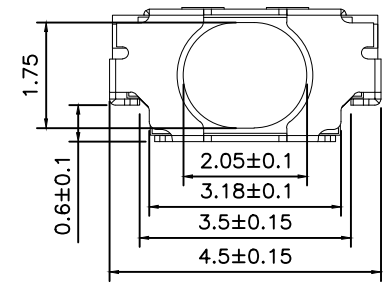
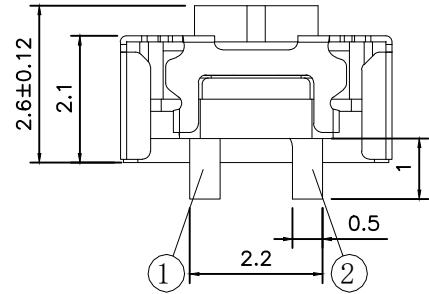
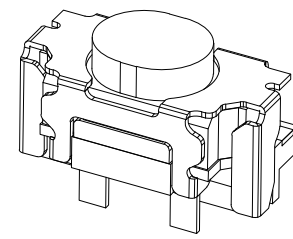
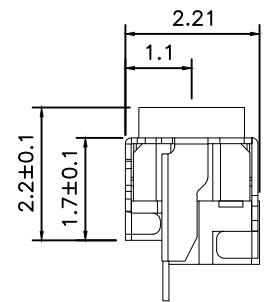

CIRCUIT DIAGRAM

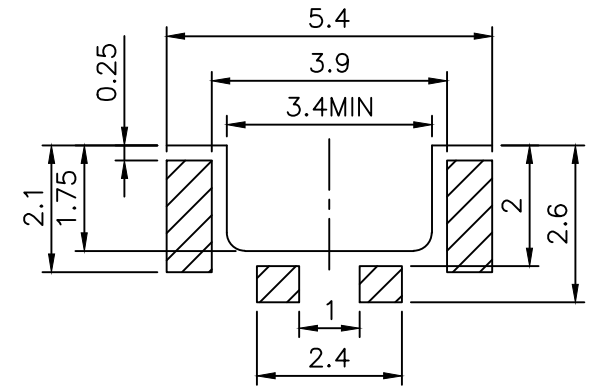

PCB. WELDING DRAWING

Specification

Operating Life	≥300,000
Contact rating	50mA@12V DC.
Insulation resistance	≥100Ω min.
Contact resistance	100mΩ max. initial.
Dielectric Strength	250 V AC(1mm)
Travel	0.15±0.1mm

F	button	LCP	1	Black
E	Cover	Stainless steel	1	Gold plated
D	Dust-proof membrane	polyimide	1	orange
C	shrapnel	Stainless steel	2	Plated Ag
B	noumenon	LCP	1	Black
A	Card	Phosphor copper	1	Plated Ag
ITEM	DESCRIPTION	MATERIAL	QTY	FINISH/COL DR

Mechanical

PN	Operating Force(gf)	Height mm
YTS1T0352AJ00	260±50	2.6
YTS1T0351AJ00	160±50	2.6

X. ±0.50	X.° ±2°	UNITS mm
.X ±0.30	.X° ±1°	
.XX ±0.10	.XX° ±0.5°	MAT'L
.XXX ±0.05		
THESE DRAWINGS AND SPECIFICATIONS ARE THE PROPERTY OF YIYUAN TECHNOLOGY CO.,LTD AND SHALL NOT BE REPRODUCED, COPIED OR USED IN ANY MANNER WITHOUT THE PRIOR WRITTEN CONSENT OF YIYUAN TECHNOLOGY CO.,LTD Email at info@yiyuanswitches.com		FINISH
		Q'TY

**yi YUAN** 深圳市怡远科技有限公司  
SHENZHEN YIYUAN TECHNOLOGY CO.,LTD

PART NO. YTS1T035	TITLE: TACTILE SWITCH 2.2x4.5mm
APPD: ROGER	DWG NO.:
CHKD: RDC	YTS1T035
DR: BILLY WANG 2020/08/21	

Packaging:  
Reel of 3,000 pieces.

	SCALE	SHEET	REV.
	1/1	1/1	A1

## X-ON Electronics

Largest Supplier of Electrical and Electronic Components

*Click to view similar products for [Tactile Switches](#) category:*

*Click to view products by [YIYUAN](#) manufacturer:*

Other Similar products are found below :

[5GTH92001](#) [5GTH9202242](#) [6407-250V-25273P](#) [ADTSA62NV](#) [ADTSA62RV](#) [B3F-3123](#) [1977177-8](#) [1977266-1](#) [ADTSA63NV](#)  
[ADTSM21NSVTR](#) [ADTSM25RVTR](#) [ADTSM32NVTR](#) [ADTSMW64RV](#) [FSMRA4JHA04](#) [GS4.70F300QP](#) [KSC241J SP DELTA LFS](#)  
[3FTL600RAS](#) [3FTL640RAS](#) [Y96K132V0FPLFS](#) [5GTH9658222](#) [6407-250V-25343P](#) [ADTSM31NVTR](#) [2-1977120-7](#) [TSJW-5.2-260-TR](#)  
[KMT011MNGJLHS](#) [B3WN6002S](#) [70-201.0](#) [ADTSG648NV](#) [ADTSM62KSVTR](#) [ADTSM648NV](#) [95C06E3RAT](#) [5GTH96561](#) [3ATH9Q](#)  
[FSMRA8JHA04](#) [HARS0073](#) [Y97HS12A5RAFP](#) [Y97BT23B2HAFP](#) [Y33R411N9FPLFT](#) [Y31C01402FPLFS](#) [PTS645SK50SMTR92](#)  
[ADTSM32NVB](#) [KMS233GPWTLFG](#) [Y78B64124FP](#) [PTS638SK25SMTR2LFS](#) [Y96D113G0FP LFS](#) [Y33A812C5FP LFT](#) [Y56B2D120FP](#)  
[LFS](#) [PTS645 DVM83-BN125-2 LFS](#) [B3W 1000G](#) [KSC621G OL LFS](#)