

RoHS Compliant

REVISIONS							
Rev	DESCRIPTION	DATE	DRAWER	Rev	DESCRIPTION	DATE	DRAWER
A	Initial Drawing	2015.12.11	LUO JIE	C			
B				D			

SPECIFICATIONS			
RATING	RATING	TIMING	TIMING
CONTACT RESISTANCE	CONTACT-RESISTANCE BEFORE OPERATION	OPERATION (TORQUE)	OPERATION (TORQUE)
INSULATION RESISTANCE	INSULATION-RESISTANCE	STROKE (ANGLE)	STROKE (ANGLE)
WITHSTAND VOLTAGE	WITHSTAND-VOLTAGE	CONTACT RESISTANCE (AFTER LIFE CYCLES)	CONTACT-RESISTANCE AFTER LIFE CYCLES TEST
REMARKS:			

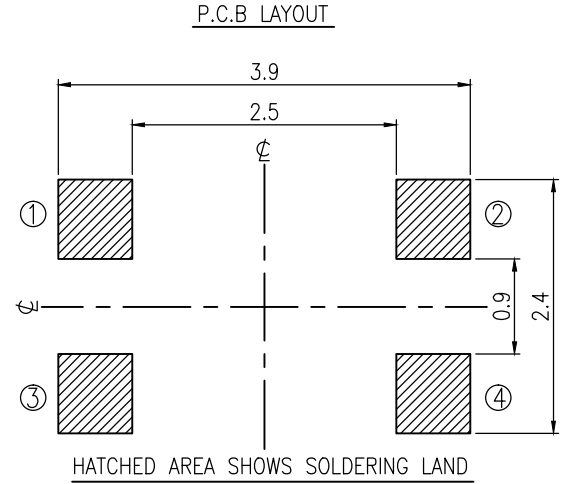
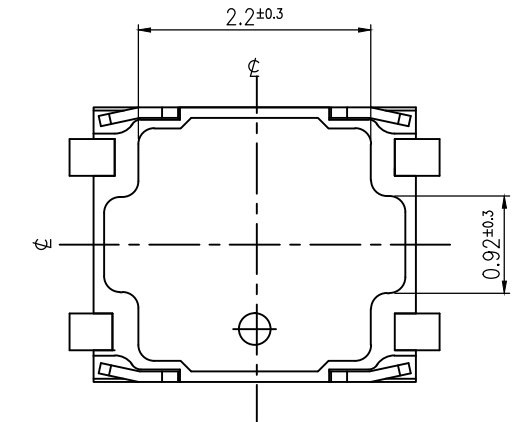
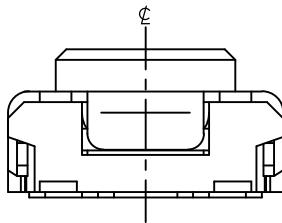
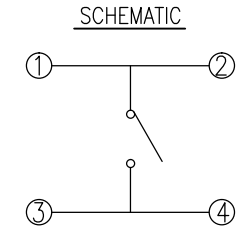
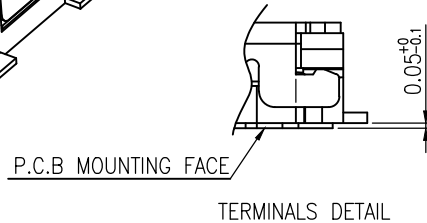
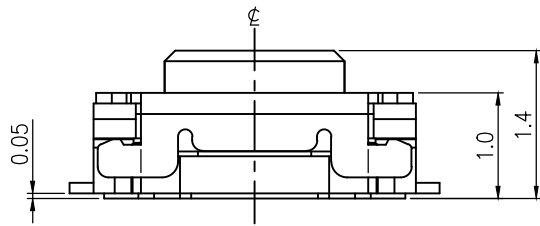
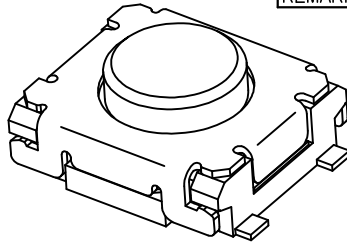
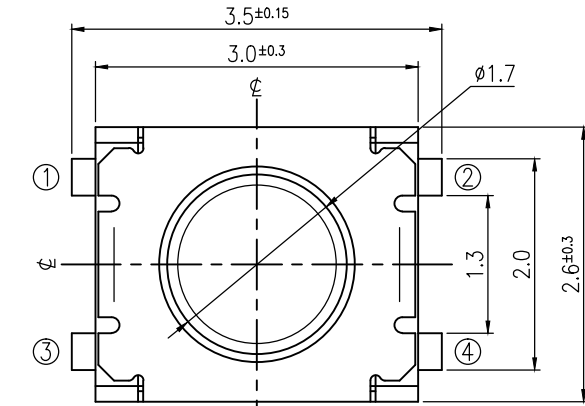

MODEL NO.	OPERATING FORCE	LIFE
YTS830GM	160±50 gf	500,000 CYCLES
YTS830GG	450±80 gf	200,000 CYCLES

TOLERANCES UNLESS OTHERWISE SPECIFIED ±0.1		SIGNATURES		DATE	MODEL
DRAWER	Drawer			Date	TITLE
CHECKED					PART-NAME
REVIEWED					NO.
APPROVALS					PART-NO.

X-ON Electronics

Largest Supplier of Electrical and Electronic Components

Click to view similar products for [Tactile Switches](#) category:

Click to view products by [YIYUAN](#) manufacturer:

Other Similar products are found below :

[5GTH92001](#) [5GTH9202242](#) [ADTSA62NV](#) [ADTSA62RV](#) [B3F-3123](#) [1977177-8](#) [1977266-1](#) [ADTSA63NV](#) [ADTSM21NSVTR](#)
[ADTSM25RVTR](#) [ADTSM32NVTR](#) [ADTSMW64RV](#) [FSMRA4JHA04](#) [GS4.70F300QP](#) [3ESH9R](#) [KSC241J](#) [SP DELTA LFS](#) [3FTL600RAS](#)
[3FTL640RAS](#) [Y96K132V0FPLFS](#) [5GSH92001](#) [5GTH9658222](#) [ADTSM31NVTR](#) [2-1977120-7](#) [TSJW-5.2-260-TR](#) [KMT011MNGJLHS](#)
[ADTSG648NV](#) [ADTSM62KSVTR](#) [ADTSM648NV](#) [95C06E3RAT](#) [3ATH9Q](#) [FSM4JSMLXTR](#) [FSM4JSMXL](#) [FSMRA8JHA04](#) [HARS0073](#)
[Y97HS12A5RAFP](#) [Y97BT23B2HAFP](#) [Y33R411N9FPLFT](#) [Y31C01402FPLFS](#) [PTS645SK50SMTR92](#) [ADTSM32NVB](#) [KMS233GPWTLFG](#)
[Y78B42324FP](#) [Y33R21116FPLFT](#) [Y31B43131FPLFG](#) [Y78B64124FP](#) [Y71243251FP](#) [Y33R31119FPLFT](#) [Y97HS12A5TAFP](#)
[PTS638SK25SMTR2LFS](#) [Y97LT25BADBFP](#)