

RoHS

CAD GENERATED DRAWING. DON'T CHANGE BY HAND.

REV.	ECN. NO.	APPD.

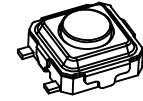
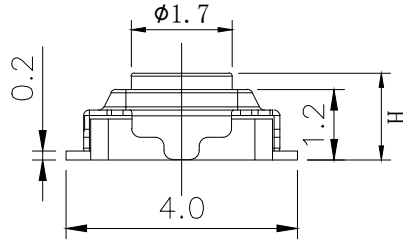
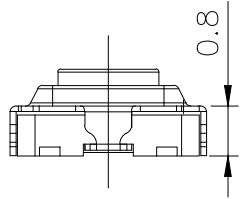
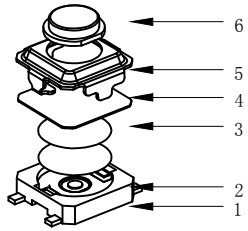

	H
A	1.5
B	1.7
C	2.0

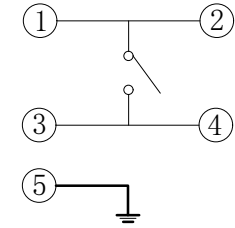

CIRCUIT DIAGRAM

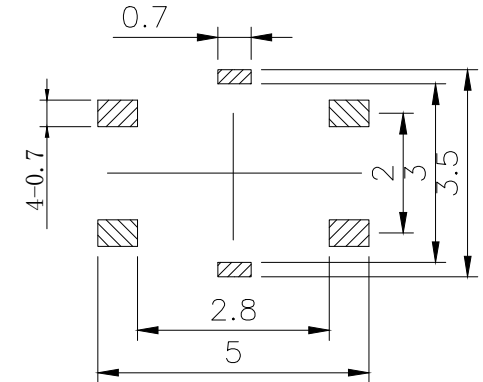

PCB. WELDING DRAWING

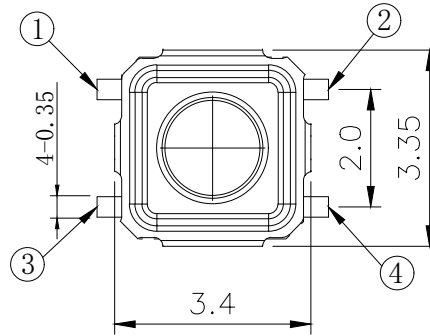

Specification

Rate voltage. current	50mA DC12V
Contact resistance	≤100mΩ
Operating force	160±50gf
Travel	0.20±0.10mm
Insulated resistance	≥100MΩ
Dielectric strength	≥250VAC/1min
Life cycle	≥100000次

6	Button	1	LCP	
5	Cover	1	Stainless steel	Silver
4	Dust film	1	Polyimide	Orange
3	Shrapnel	2	Stainless steel	Silver
2	Housing	1	LCP	Gray
1	Cards	1	Brass	Silver
ITEM	PART NAME	Q' TY	MATERIAL	FINSH/COLOR

X.	±0.50	X. °	± 2°	UNITS mm
.X	±0.30	.X°	± 1°	
.XX	±0.10	.XX°	± 0.5°	MAT'L /
.XXX	±0.05			
THESE DRAWINGS AND SPECIFICATIONS ARE THE PROPERTY OF YIYUAN TECHNOLOGY CO.,LTD AND SHALL NOT BE REPRODUCED, COPIED OR USED IN ANY MANNER WITHOUT THE PRIOR WRITTEN CONSENT OF YIYUAN TECHNOLOGY CO.,LTD				FINISH /



深圳市怡远科技有限公司  
SHENZHEN YIYUAN TECHNOLOGY CO., LTD

PART NO.  
YTS-A007-1H

TITLE:  
TACTILE SWITCH

APPD: ROGER

DWG NO. :  
YTS-A007-1H

CHKD: ROC

DR: BILLY WANG 2020/08/21

	SCALE	SHEET	REV.
	1/1	1/1	A1

## X-ON Electronics

Largest Supplier of Electrical and Electronic Components

*Click to view similar products for [Tactile Switches](#) category:*

*Click to view products by [YIYUAN](#) manufacturer:*

Other Similar products are found below :

[5GTH92001](#) [5GTH9202242](#) [ADTSA62NV](#) [ADTSA62RV](#) [B3F-3123](#) [1977177-8](#) [1977266-1](#) [ADTSA63NV](#) [ADTSM21NSVTR](#)  
[ADTSM25RVTR](#) [ADTSM32NVTR](#) [ADTSMW64RV](#) [FSMRA4JHA04](#) [GS4.70F300QP](#) [3ESH9R](#) [KSC241J SP DELTA LFS](#) [3FTL600RAS](#)  
[3FTL640RAS](#) [Y96K132V0FPLFS](#) [5GSH92001](#) [5GTH9658222](#) [ADTSM31NVTR](#) [2-1977120-7](#) [TSJW-5.2-260-TR](#) [KMT011MNGJLHS](#)  
[ADTSG648NV](#) [ADTSM62KSVTR](#) [ADTSM648NV](#) [95C06E3RAT](#) [3ATH9Q](#) [FSM4JSMLXTR](#) [FSM4JSMXL](#) [FSMRA8JHA04](#) [HARS0073](#)  
[Y97HS12A5RAFP](#) [Y97BT23B2HAFP](#) [Y33R411N9FPLFT](#) [Y31C01402FPLFS](#) [PTS645SK50SMTR92](#) [ADTSM32NVB](#) [KMS233GPWTLFG](#)  
[Y78B42324FP](#) [Y33R21116FPLFT](#) [Y31B43131FPLFG](#) [Y78B64124FP](#) [Y71243251FP](#) [Y33R31119FPLFT](#) [Y97HS12A5TAFP](#)  
[PTS638SK25SMTR2LFS](#) [Y97LT25BADBFP](#)