

RoHS

CAD GENERATED DRAWING. DON'T CHANGE BY HAND.

REV.	ECN. NO.	APPD.

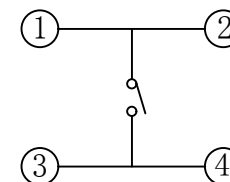
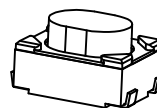
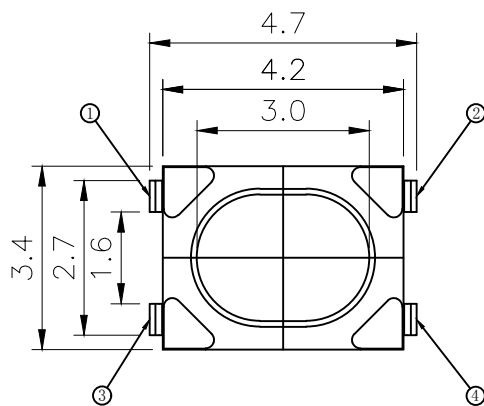
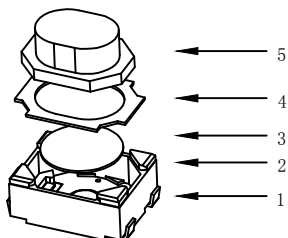

CIRCUIT DIAGRAM

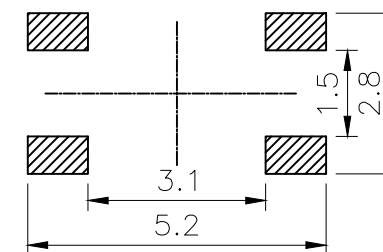
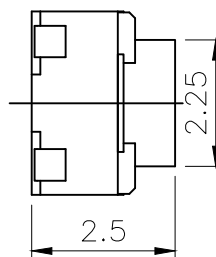

PCB. WELDING DRAWING

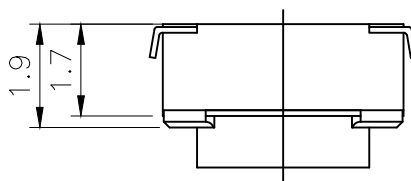

Specification

Rate voltage. current	50mA DC12V
Contact resistance	≤100mΩ
Operating force	260±50gf
Travel	0.20±0.10mm
Insulated resistance	≥100MΩ
Dielectric strength	≥250VAC/1min
Life cycle	≥100000次

ITEM	PART NAME	Q' TY	MATERIAL	FINSH/COLOR
5	Button	1	PPA	White
4	Cover	1	Phosphor copper	Copper tin plating
3	Shrapnel	1	Stainless steel	Silver
2	Housing	1	LCP	White
1	Cards	1	Phosphor copper	Silver

THESE DRAWINGS AND SPECIFICATIONS ARE THE PROPERTY OF YIYUAN TECHNOLOGY CO.,LTD AND SHALL NOT BE REPRODUCED, COPIED OR USED IN ANY MANNER WITHOUT THE PRIOR WRITTEN CONSENT OF YIYUAN TECHNOLOGY CO.,LTD

X. ±0.50	X.° ±2°	UNITS
.X ±0.30	.X° ±1°	mm
.XX ±0.10	.XX° ±0.5°	MAT'L
.XXX ±0.05		FINISH
		Q' TY



深圳市怡远科技有限公司
SHENZHEN YIYUAN TECHNOLOGY CO.,LTD

PART NO.
YTS-A016-2

TITLE:
TACTILE SWITCH

APPD: ROGER

DWG NO. :
YTS-A016-2

CHKD: ROC
DR: BILLY WANG 2020/08/21

	SCALE	SHEET	REV.
	1/1	1/1	A1

X-ON Electronics

Largest Supplier of Electrical and Electronic Components

Click to view similar products for [Tactile Switches](#) category:

Click to view products by [YIYUAN](#) manufacturer:

Other Similar products are found below :

[5GTH92001](#) [5GTH9202242](#) [ADTSA62NV](#) [ADTSA62RV](#) [B3F-3123](#) [1977177-8](#) [1977266-1](#) [ADTSA63NV](#) [ADTSM21NSVTR](#)
[ADTSM25RVTR](#) [ADTSM32NVTR](#) [ADTSMW64RV](#) [FSMRA4JHA04](#) [GS4.70F300QP](#) [3ESH9R](#) [KSC241J SP DELTA LFS](#) [3FTL600RAS](#)
[3FTL640RAS](#) [Y96K132V0FPLFS](#) [5GSH92001](#) [5GTH9658222](#) [ADTSM31NVTR](#) [2-1977120-7](#) [TSJW-5.2-260-TR](#) [KMT011MNGJLHS](#)
[ADTSG648NV](#) [ADTSM62KSVTR](#) [ADTSM648NV](#) [95C06E3RAT](#) [3ATH9Q](#) [FSM4JSMLXTR](#) [FSM4JSMXL](#) [FSMRA8JHA04](#) [HARS0073](#)
[Y97HS12A5RAFP](#) [Y97BT23B2HAFP](#) [Y33R411N9FPLFT](#) [Y31C01402FPLFS](#) [PTS645SK50SMTR92](#) [ADTSM32NVB](#) [KMS233GPWTLFG](#)
[Y78B42324FP](#) [Y33R21116FPLFT](#) [Y31B43131FPLFG](#) [Y78B64124FP](#) [Y71243251FP](#) [Y33R31119FPLFT](#) [Y97HS12A5TAFP](#)
[PTS638SK25SMTR2LFS](#) [Y97LT25BADBFP](#)