

RoHS

CAD GENERATED DRAWING. DON'T CHANGE BY HAND.

REV.	ECN. NO.	APPD.

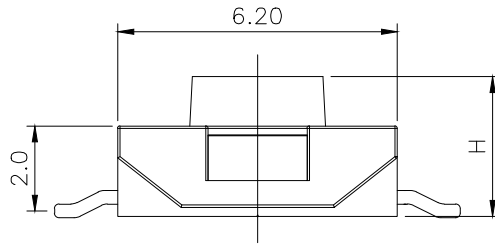
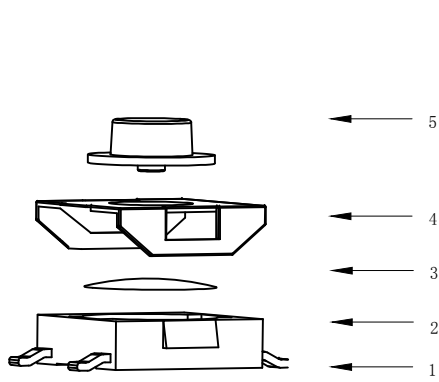

H			
A	2.5	B	3.1
C	3.5	D	4.0

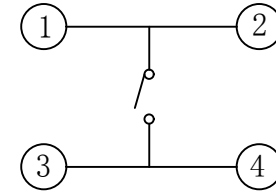

CIRCUIT DIAGRAM

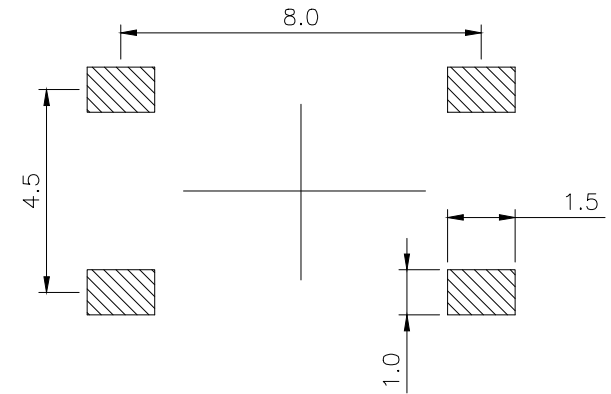
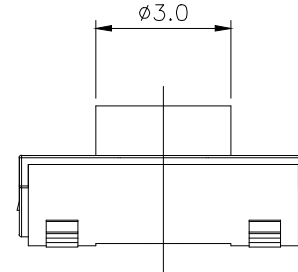
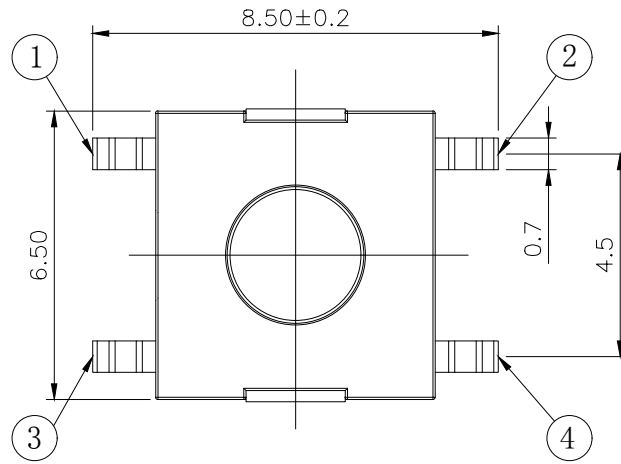
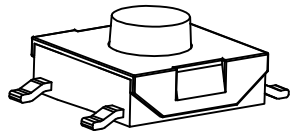

PCB WELDING DRAWING

Specification

Rate voltage, current	50mA DC12V
Contact resistance	≤100mΩ
Operating force	250±50gf
Travel	0.25±0.10mm
Insulated resistance	≥100MΩ
Dielectric strength	≥250VAC/1min
Life cycle	≥100000次

5	Button	1	PPA	Red
4	Cover	1	Iron	Copper tin plating
3	Shrapnel	1	Stainless steel	Silver
2	Housing	1	PPA	Black
1	Cards	1	Brass	Silver
ITEM	PART NAME	Q'TY	MATERIAL	FINSH/COLOR

X.	±0.50	X.°	± 2°
.X	±0.30	.X°	± 1°
.XX	±0.10	.XX°	± 0.5°
.XXX	± 0.05		

THESE DRAWINGS AND SPECIFICATIONS ARE THE PROPERTY OF YIYUAN TECHNOLOGY CO.,LTD AND SHALL NOT BE REPRODUCED, COPIED OR USED IN ANY MANNER WITHOUT THE PRIOR WRITTEN CONSENT OF YIYUAN TECHNOLOGY CO.,LTD

UNITS	mm
MAT'L	—
FINISH	—
Q'TY	—

PART NO.	YTS-E004-2H
APPD:	ROGER
CHKD:	ROC
DR:	BILLY WANG 2020/08/21

**yi YUAN** 深圳市怡远科技有限公司  
SHENZHEN YIYUAN TECHNOLOGY CO., LTD

TITLE: TACTILE SWITCH

DWG NO.: YTS-E004-2H

SCALE	SHEET	REV.
1/1	1/1	A1

## X-ON Electronics

Largest Supplier of Electrical and Electronic Components

*Click to view similar products for [Tactile Switches](#) category:*

*Click to view products by [YIYUAN](#) manufacturer:*

Other Similar products are found below :

[5GTH92001](#) [5GTH9202242](#) [ADTSA62NV](#) [ADTSA62RV](#) [B3F-3123](#) [1977177-8](#) [1977266-1](#) [ADTSA63NV](#) [ADTSM21NSVTR](#)  
[ADTSM25RVTR](#) [ADTSM32NVTR](#) [ADTSMW64RV](#) [FSMRA4JHA04](#) [GS4.70F300QP](#) [3ESH9R](#) [KSC241J](#) [SP DELTA LFS](#) [3FTL600RAS](#)  
[3FTL640RAS](#) [Y96K132V0FPLFS](#) [5GSH92001](#) [5GTH9658222](#) [ADTSM31NVTR](#) [2-1977120-7](#) [TSJW-5.2-260-TR](#) [KMT011MNGJLHS](#)  
[ADTSG648NV](#) [ADTSM62KSVTR](#) [ADTSM648NV](#) [95C06E3RAT](#) [3ATH9Q](#) [FSM4JSMLXTR](#) [FSM4JSMXL](#) [FSMRA8JHA04](#) [HARS0073](#)  
[Y97HS12A5RAFP](#) [Y97BT23B2HAFP](#) [Y33R411N9FPLFT](#) [Y31C01402FPLFS](#) [PTS645SK50SMTR92](#) [ADTSM32NVB](#) [KMS233GPWTLFG](#)  
[Y78B42324FP](#) [Y33R21116FPLFT](#) [Y31B43131FPLFG](#) [Y78B64124FP](#) [Y71243251FP](#) [Y33R31119FPLFT](#) [Y97HS12A5TAFP](#)  
[PTS638SK25SMTR2LFS](#) [Y97LT25BADBFP](#)