

Surface Mount Fast Recovery Rectifier

RS2A—RS2M

Features

- ◆ Low profile package
- ◆ deal for automated placement
- ◆ Glass passivated chip junction
- ◆ High forward surge capability
- ◆ Fast reverse recovery time

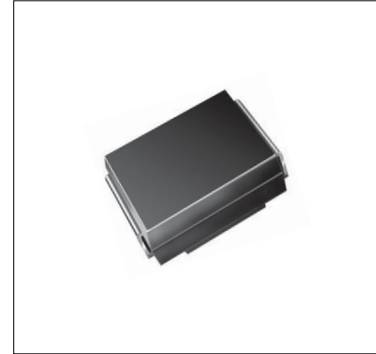

Mechanical Data

Case: DO-214AA (SMB) Molded plastic body

Terminals: Plated leads solderable per MIL-STD-750, Method 2026

High temperature soldering guaranteed: 260°C/10 seconds

Polarity: Cathode line denotes the cathode end

Mounting Position: Any

Maximum Ratings & Electrical Characteristics

Ratings at TA = 25°C unless otherwise specified

Characteristic	Symbol	RS2A	RS2B	RS2D	RS2G	RS2J	RS2K	RS2M	Units
Peak repetitive reverse voltage	VRRM	50	100	200	400	600	800	1000	V
RMS reverse voltage	VRMS	35	70	140	280	420	560	700	V
DC blocking voltage	VDC	50	100	200	400	600	800	1000	V
Maximum average forward output current	IF(AV)	2							A
Peak forward surge current, 8.3ms single half-sine-wave, @TJ = 25°C	IFSM	50							A
Rating for fusing (t < 8.3ms)	I2t	10.4							A2sec
Maximum instantaneous forward voltage @ 2A	VF	1.3							V
Maximum Reverse current Rated VR @TA = 25°C	IR	5							μ A
		@TA = 125°C							
Maximum Reverse Recovery Time IF = 0.5 A, IR = 1 A, Irr = 0.25 A.	Trr	150				250	500		nS

Thermal Characteristics

Characteristic	Symbol	RS2A	RS2B	RS2D	RS2G	RS2J	RS2K	RS2M	Units
Typical thermal resistance (Note 1)	R θJA	55							°C /W
	R θJL	18							
Operating junction temperature range	TJ	- 55 ---- + 150							°C
Storage temperature range	TSTG	- 55 ---- + 150							°C

Note

(1) Device mounted on PCB with 7 mm x 7mm copper pad areas

Surface Mount Fast Recovery Rectifier

RS2A—RS2M

Ratings and Characteristic Curves ($T_A=25^\circ\text{C}$ unless otherwise noted)

Fig.1-Forward Current Derating Curve

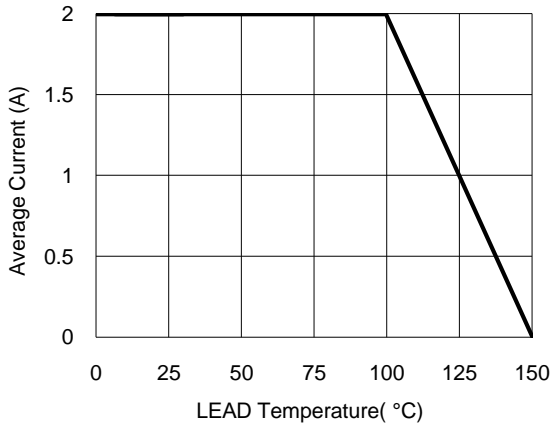

Fig.2- Surge Current Derating Curve

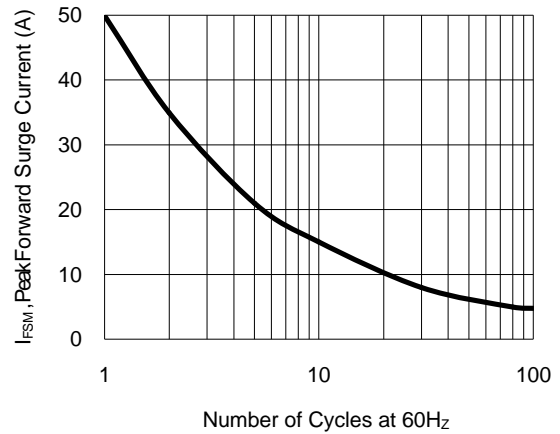

Fig.3- Typical Forward Voltage Characteristic

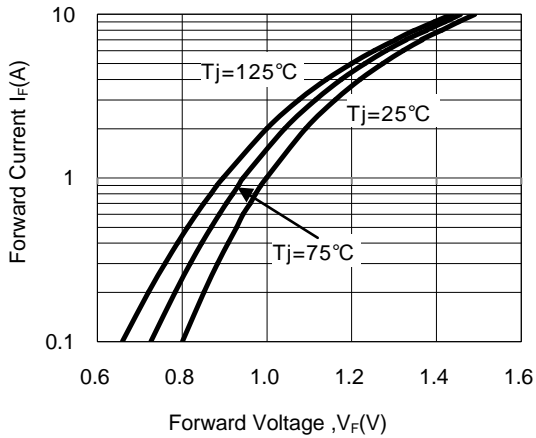
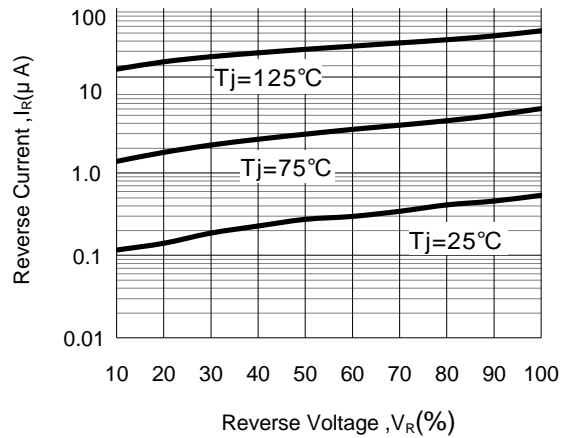

Fig.4- Typical Reverse Characteristic



Surface Mount Fast Recovery Rectifier

RS2A—RS2M

Package Outline Dimensions(unit:mm)

DO-214AA (SMB)

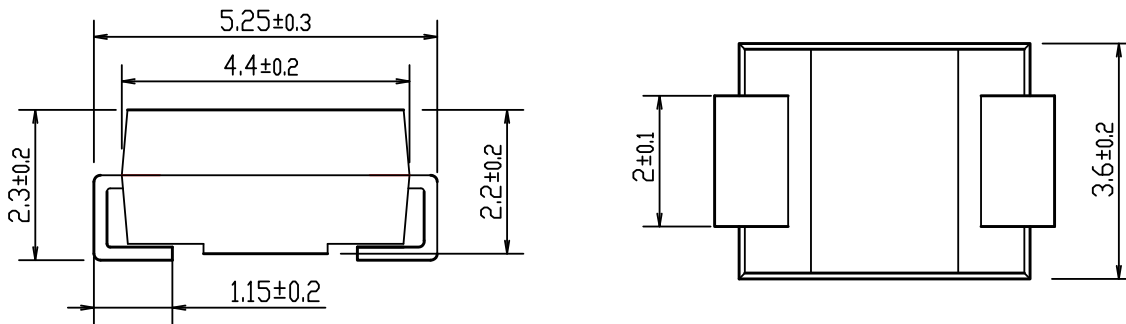

Mounting Pad Layout(unit:mm)

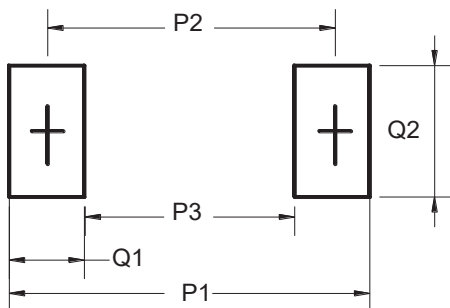

Dim	Millimeters
P1	6.80
P2	4.30
P3	1.80
Q1	2.50
Q2	2.30

Ordering Information

Part No.	Marking	Package	Shipping
RS2A	RS2A	SMB	3000PCS /Tape&Reel
RS2B	RS2B	SMB	3000PCS /Tape&Reel
RS2D	RS2D	SMB	3000PCS /Tape&Reel
RS2G	RS2G	SMB	3000PCS /Tape&Reel
RS2J	RS2J	SMB	3000PCS /Tape&Reel
RS2K	RS2K	SMB	3000PCS /Tape&Reel
RS2M	RS2M	SMB	3000PCS /Tape&Reel

X-ON Electronics

Largest Supplier of Electrical and Electronic Components

Click to view similar products for [Rectifiers](#) category:

Click to view products by [Yjsemi](#) manufacturer:

Other Similar products are found below :

[70HFR40](#) [FR105 R0](#) [RL252-TP](#) [150KR30A](#) [1N5397](#) [1N4002G](#) [1N4005-TR](#) [UFS120Je3/TR13](#) [JANS1N6640US](#) [481235F](#)
[RRE02VS6SGTR](#) [067907F](#) [MS306](#) [70HF40](#) [T110HF60](#) [T85HFL60S02](#) [US2JFL-TP](#) [A1N5404G-G](#) [CRS12\(T5L,TEMQ\)](#) [ACGRB207-HF](#)
[CLH07\(TE16L,Q\)](#) [CLH03\(TE16L,Q\)](#) [ACGRC307-HF](#) [ACEFC304-HF](#) [NTE6356](#) [NTE6359](#) [85HFR60](#) [40HFR60](#) [70HF120](#) [85HFR80](#)
[D126A45C](#) [SCF7500](#) [D251N08B](#) [SCHJ22.5K](#) [SM100](#) [SCPA2](#) [SDHD5K](#) [ACGRA4001-HF](#) [D1821SH45T PR](#) [D1251S45T](#) [NTE6358](#)
[NTE5850](#) [NTE5819](#) [NTE5837](#) [NTE5892](#) [NTE5900](#) [NTE5911](#) [NTE5915](#) [NTE5921](#) [NTE6104](#)