

■ Features

- Excellent for attenuation characteristics in low frequency range.
- Withstand voltage:AC 1.8KV.
- Flat wire used for excellent EMC noise suppressed.
- In addition to the standard versions of parameters shown here,custom designed are available meet your exact requirement.

■ Applications

- Ideally used in noise prevention for TV,VCR,AV etc.

■ Shapes and Dimensions (Unit: mm)

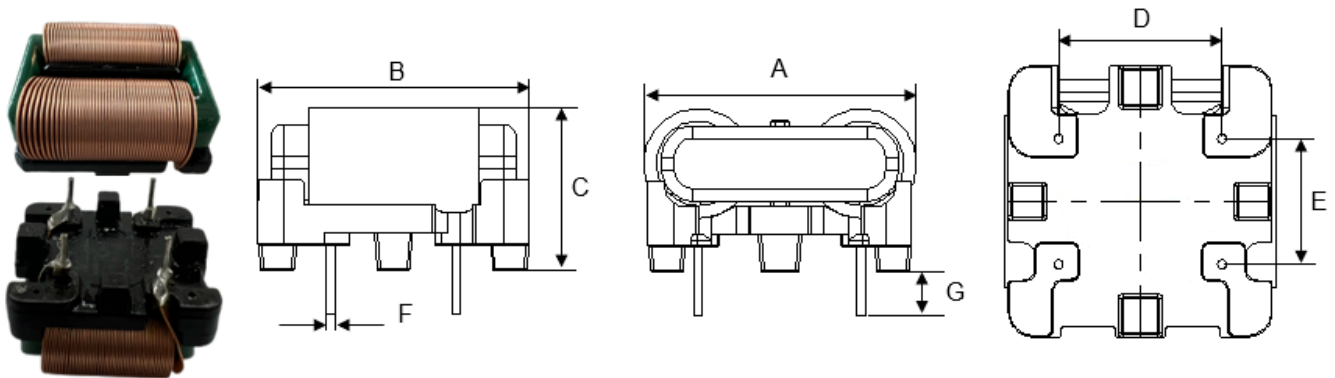

PCB aperture $\geq \Phi 1.2\text{mm}$

TYPE	A Max.	B Max.	C Max.	D	E	F	G
YDFW1918T-202W04015	24.5	22.5	15.5	13.0±0.5	10.0±0.5	0.7±0.1	3.5±0.5

■ Winding construction:

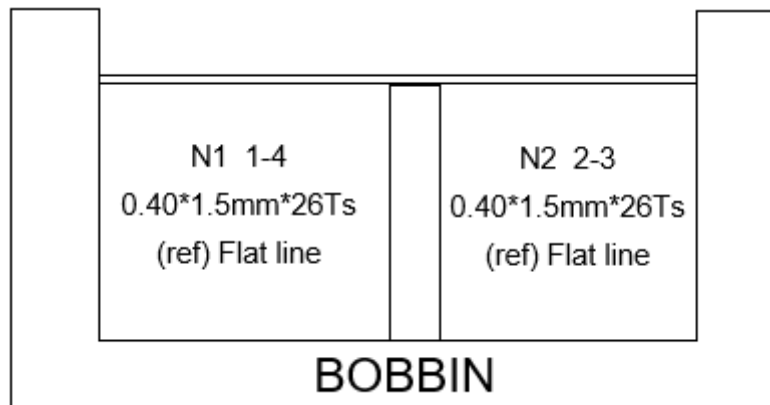

■ Connection

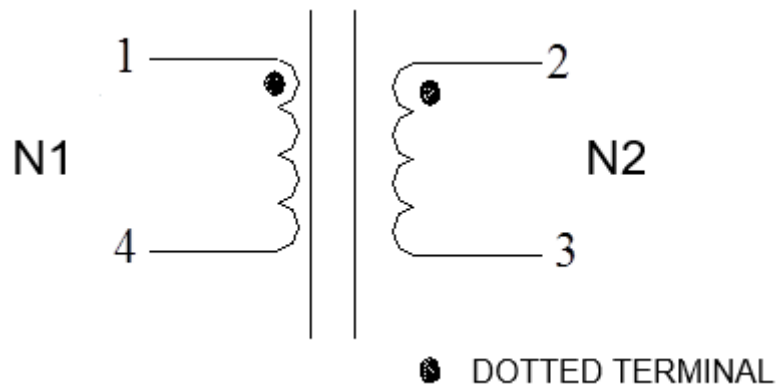

■ Manufacture specification

1. Base (2+2), magnetic core is YDFW1918 magnetic core; Lead Pitch:10*13
2. Winding sequence: N1 winding N2 at the same time;
3. The product needs to be immersed in oil and lead free process;

■ Electric Characteristics:

NO.	ITEMS	MEASURED POINT	TECHNICAL DATA	TESTING CONDITION	APPARATUS
1	INDUCTANCE	$L_{1-4}=L_{2-3}$	2mH Min.	1KHz,0.25V SER 25°	HP4284A or 100 Ω internal resistance tester
2	DCR	$DCR_{1-4}=DCR_{2-3}$	50 mΩ MAX	25° short Other Pin	
3	HI-POT TEST	COIL 1 TO COIL 2	No breakdown	1.5KVAc 5mA 3 SEC	CS9912BI
		COIL - CORE		1.0KVAc 5mA 3 SEC	
4	TURNS RATIO	N1:N2	26:26	1KHz,0.25V	CH3250

■ Package semblable

- 1, Type ,Product name,QTY,manufacture period ,shipping date,supplier name and the stamp of out-inspection must be stated in the out packaging.
- 2,The same product but different manufacture period number mustn't be put in the same container.
- 3, Complete seal,no breakage on outer container,no crack is required when the customer received the goods.
- 4, The packing materials can't have any breakage when opening the container.The products should be packed in layer and spacer.If there are no enough products to a container,filler will be put in.

■ Test requirement

- 1,The label of waterproof or lettering should be needed on each minimum packing and manufacture period,type or size should be stated.
- 2,Keep the appearance neat.
- 3,During production,all products must be tested electric chacter and electricity-resistant intensity.
- 4,Before shipping,the product must be had a sampling test according to acknowledgment by national industry standard.Test report will be showed and the date of testing will be noted after qualified.

■ Material list

List 1:

ITEM	TYPE	MATERIAL	SPEC		MANUFACTURE	UL NO.
			°C	UL94		
WIRE	Φ0.40*1.5m m	1UEW	180	N/A	Guangdong liziwire Electric Technology Co Ltd	E504985
					YOU TUO ENTERPRISE CO.,LTD	E338133
Varnish	1032XXX				Shen zhen noble flower technology industrial co ltd	E213437

List 2:

ITEM	TYPE	PRODUCT MANUFACTURE	MATERIAL	SPEC		MATERIAL MANUFACTURE	UL NO.	ROHS
				°C	UL94			
BOBBIN	YDFW1918 pedestal	MEIRISHENG ELECTRONICS CO; LTD	T375HF	150	V-0	CHANG CHUN PLASTICS CO LTD	E59481	Y

List 3:

ITEM	TYPE	MATERIAL	SPEC		MANUFACTURE
			°C	UL94	
CORE	YDFW1918 pedestal	R12K	N/A	N/A	ShanDongHengRui Magent technolgy co.,ltd
		R12K OR Equivalent			ACME Electronics(guangzhou) Co.,Ltd
					JIU XIN

■ Storage conditions

- 1, Temperature - 10~40 °C Relative humidity: 30~70%.
- 2, It is forbidden to keep the product in corrosive substances, such as sulfur, chlorine or acid, or it will cause oxygen at the end and reduce the weldability.
- 3, In order to avoid the influence of moisture, dust and other substances, the product should be kept on the shelf.
- 4, The products shall be kept in the warehouse, avoiding thermal shock, vibration and direct light.

X-ON Electronics

Largest Supplier of Electrical and Electronic Components

Click to view similar products for [Common Mode Chokes / Filters](#) category:

Click to view products by [YJYCOIN](#) manufacturer:

Other Similar products are found below :

[PE-64683](#) [ST6118T-R](#) [FE3X025-10-7NL](#) [T8114NLT](#) [TCM0806G-350-2P-T](#) [TCM0806G-650-2P-T](#) [IND-0110](#) [UAL21VR0802000](#)
[UALSC023000000](#) [UALSC1020JH000](#) [UALSU10VD20010](#) [UALSU9VD070100](#) [36-00037](#) [CM7060M132R-10](#) [UALW21HS072450](#)
[UALSU9H0208000](#) [UAL24VK06450CH](#) [PLT10HH501100PNB](#) [PLT10HH401100PNB](#) [PLT10HH1026R0PNB](#) [36-00029-01](#) [PE-67531](#)
[TLH10UB](#) [113 0R5](#) [2752045447](#) [CM8663Z161B-10](#) [7351V](#) [CMF16-153131](#) [T8116NLT](#) [CMS2-10-R](#) [FE2X10-4-2NL](#) [T8003NLT](#) [CTX01-](#)
[13663](#) [CTX66-19521-R](#) [RC212-0.5-10M](#) [RC112-0.4-15M](#) [RC212-0.6-6M8](#) [RC212-0.4-15M](#) [RC112-0.3-30M](#) [4534-3](#)
[WTCF2012Z0M751PB](#) [PH9408.814NLT](#) [B82498B3221J000](#) [PAC6006.364NLT](#) [PAC6006.444NLT](#) [PAC6006.204NLT](#) [PH9407.204NLT](#)
[PAC6006.264NLT](#) [PH9408.105NLT](#) [PH9408.494NLT](#) [PAC6006.104NLT](#)