

**■ Features**

- High density packaging with a pitch of 2.54mm(0.1 inch) max. is possible.  
This series requires less space and has greater EMI suppression effects.
- Different types with the same shape are available.
- Excellent in physical properties, such as terminal strength, flexure strength, soldering resistance and solderability.
- Applicable to both flow and reflow soldering.
- High impedance cover wide frequency ranges.
- YI series can be used in high current circuits due to its low DC resistance.
- Operating temperature: -40°C ~ +125°C.

**■ Applications**

- Computers and peripheral devices, personal computers, VCR and cameras.
- Noise suppression in digital equipments, car stereo, car engines controllers and OA electronic instruments.
- Communication equipment.

**■ Product Identification**

$\frac{YI}{(1)}$      $\frac{\square\square\square\square\square\square}{(2)}$      $\frac{\square}{(3)}$      $\frac{\square\square\square}{(4)}$  -  $\frac{\square\square\square\square}{(5)}$

- (1) : Type
- (2) : Dimensions
- (3) : Material Code
- (4) : Impedance
- (5) : Rated Current

**Shapes and Dimensions (Unit: mm)**

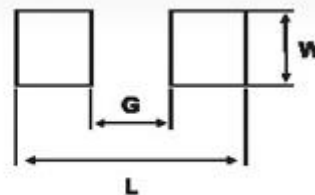
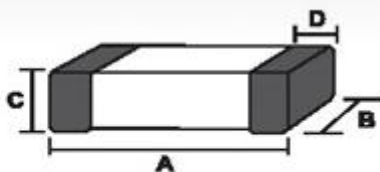
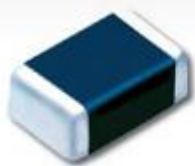

TYPE	A	B	C	D	L	W	G
YI321611	3.2±0.2	1.6±0.2	1.1±0.2	0.5±0.3	4.40	1.80	1.20

**Electrical Requirements**

Part Number	Impedance(Ω) ±25%	Test Freq. (MHz)	DCR MAX. (Ω)	Rating Current MAX (A)
YI321611U391-3R0T	390	100	0.05	3.0

TEST INSTRUMENTS:

HP 4338A MILLIOHM METER

HP 4291B RF IMPEDANCE/MATERIAL ANALYZER

**Impedance VS. Frequency characteristic**

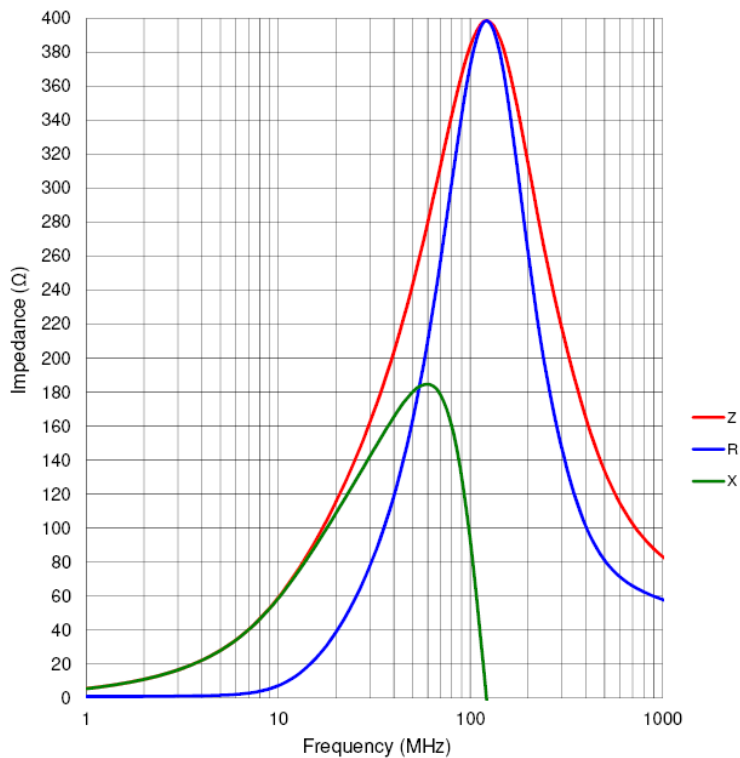

**Reliability test**

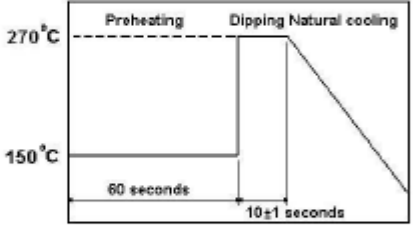
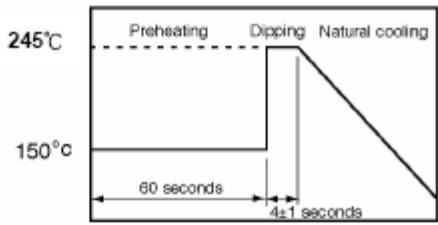
Item	Performance	Test condition
Operating temperature range	-55 °C to + 125 °C	
Storage temperature and umidity ranges	40 °C MAX., 70% RH MAX.	
Soldering heat resistance	The chip shall not be cracks. More than 75% of terminal electrode shall be covered with solder.	Preheat: 150 °C, 60 seconds Solder temperature : $270 \pm 5$ °C Flux: Rosin Dip time: $10 \pm 1$ seconds 
Solderability	More than 90% of the terminal electrode shall be covered with new solder.	Preheat: 150 °C, 60 seconds Solder temperature: $245 \pm 5$ °C Flux: Rosin Dip time: $4 \pm 1$ seconds 

**Recommended Soldering Conditions**

(REFLOW TEMPERATURE PROFILE) **Lead-Free**

A	$260 \pm 5^{\circ}\text{C}$
B	$230 \pm 5^{\circ}\text{C}$
C	$30 \pm 10 \text{ sec}$
D	$150^{\circ}\text{C}$
E	$180^{\circ}\text{C}$
F	$90 \pm 30 \text{ sec}$

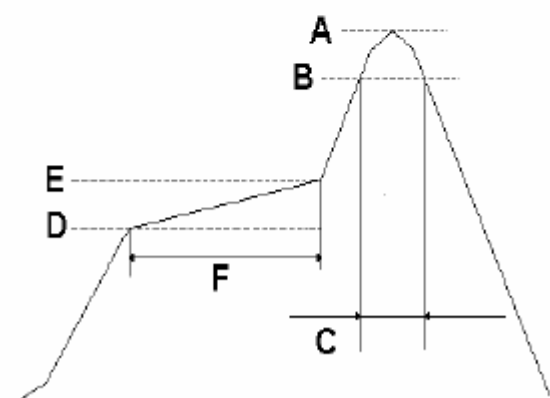

**Reliability test**

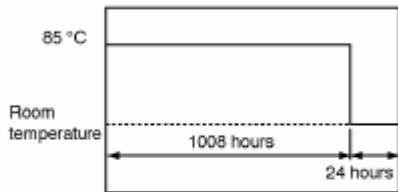
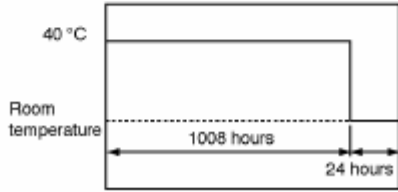
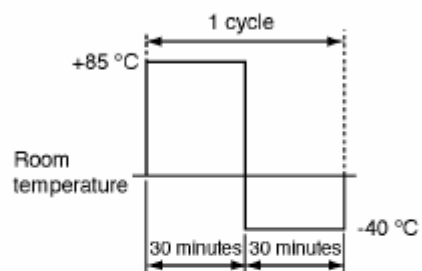
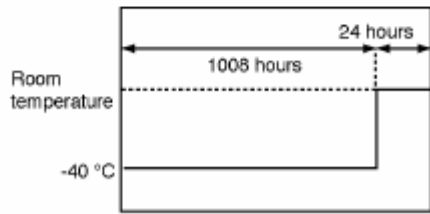
Item	Performance	Test condition
High temperature resistance	Appearance: Ferrite shall not be damaged. Impedance: Within±20% of the initial value.	Temperature: 85±2℃ Testing time: 1008±12 hours Measurement: After placing for 24 hours min. 
Humidity resistance	Appearance: Ferrite shall not be damaged. Impedance: Within±20% of the initial value	Humidity: 90 to 95% RH Temperature: 40±2℃ Testing time: 1008±12 hours Measurement: After placing for 24 hours min. 
Thermal Shock	Appearance: Cracking, chipping or any other defects harmful to the characteristics shall not be allowed. Impedance: Within±20% of the initial value	Temperature: -40℃, +85℃, kept stabilized for 30 minutes each Cycle: 100 cycles Measurement: After placing for 24 hours min. 
Low temperature storage life test	Appearance: Cracking, chipping or any other defects harmful to the characteristics shall not be allowed. Impedance: Within±20% of the initial value.	Temperature: -40±2℃ Testing time: 1008±12 hours Measurement: After placing for 24 hours min. 

**■ Taping Dimensions(Unit:mm)**

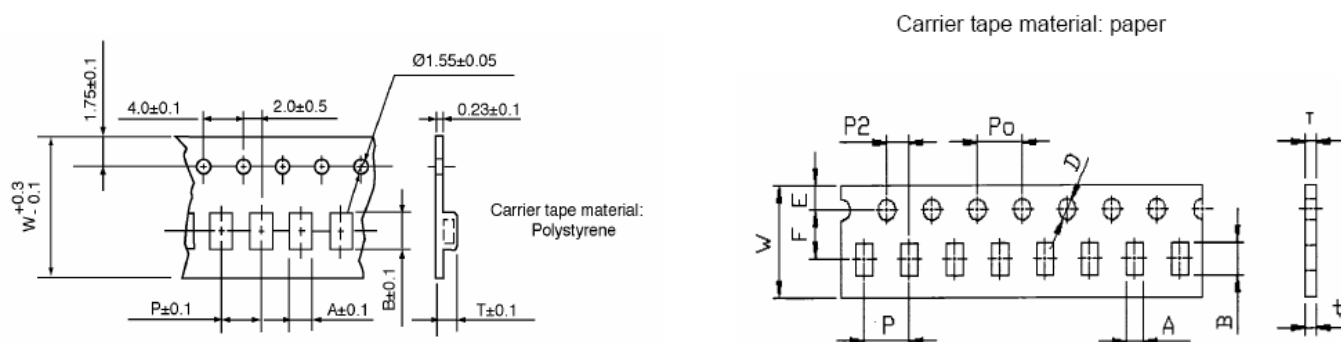

Material:Paper						
TYPE	A	B	W	P	T	CHIPS/REEL
100505	0.62	1.12	8	2	0.60	10000
160808	1.10	1.90	8	4	0.95	4000
201209	1.50	2.30	8	4	0.95	4000
Material:Polystyrene						
TYPE	A	B	W	P	T	CHIPS/REEL
160808	1.01	1.80	8	4	1.02	4000
201209	1.42	2.25	8	4	1.04	4000
201212	1.50	2.35	8	4	1.45	3000
321611	1.88	3.50	8	4	1.27	3000
322513	2.77	3.42	8	4	1.55	2000
451616	1.93	4.95	12	4	1.93	2000
453215	3.66	4.95	12	8	1.85	1000
YA3216M4	1.88	3.50	8	4	1.40	3000

**Reel Dimensions(Unit:mm)**

Material:Paper, Plastic

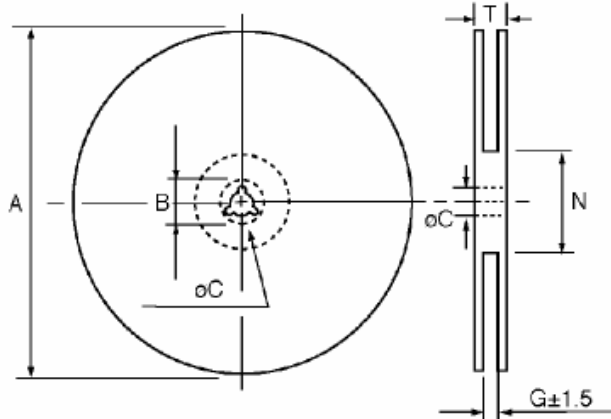

TYPE	8mm	12mm
A	178±2	178±2
B	21.0±0.8	21.0±0.8
C	13.0±0.8	13.0±0.8
G	10.0	14.0
N	75	75
T	12.5	16.5

**Direction of rolling**

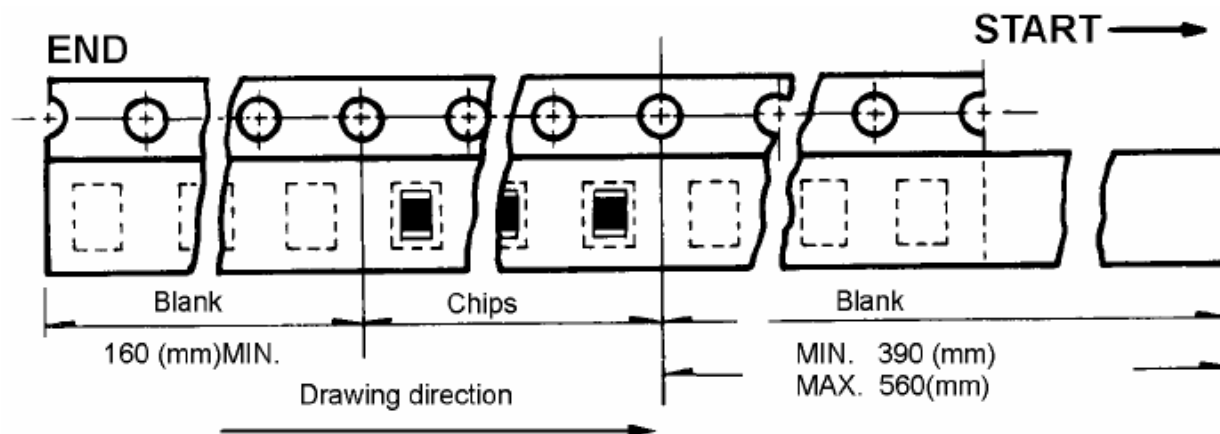

## X-ON Electronics

Largest Supplier of Electrical and Electronic Components

*Click to view similar products for [Ferrite Beads](#) category:*

*Click to view products by [YJYCOIN](#) manufacturer:*

Other Similar products are found below :

[CZB1EGTTP700P](#) [CZB1JGTTD152P](#) [CZB1JGTTD601P](#) [CZB2AFTTD800P](#) [CZB2AGTTD121P](#) [CZB2AGTTD601P](#) [CZB2BFTTE600P](#)  
[PE-0402FB121ST](#) [NCB0603R301TR050F](#) [NCB0805A320TR050F](#) [NCB-H1206B680TR300F](#) [SMB2.5-1TR](#) [SMB2.5R-2](#) [CZB1EGTTP121P](#)  
[CZB1JGTTD102P](#) [CZB1JGTTD121P](#) [CZB1JGTTD221P](#) [CZB1JGTTD600P](#) [CZB2AGTTD301P](#) [CZB2BFTTE301P](#) [CZB2BFTTE601P](#)  
[4221R-1](#) [4221R-2](#) [4221R-3](#) [432703041971](#) [EMI0805R-2000](#) [EMI0805R-600](#) [SBY100505T-100Y-N](#) [NCB-GH0402D121TR060F](#) [NCB-](#)  
[H1812D125TR150F](#) [CZB2AGTTD102P](#) [NCB0402P301TR005F](#) [NCB0603R152TR030F](#) [NCB0805A121TR050F](#) [NCB0805A301TR070F](#)  
[NCB3312K900TR500F](#) [NCB-H0805A221TR300F](#) [NCB-H1806E181TR300F](#) [NCB0402P221TR030F](#) [NCB0402P300TR030F](#)  
[NCB0402P601TR030F](#) [NCB0805A102TR040F](#) [NCB1806E151TR020F](#) [NCB-H0402P100TR200F](#) [NCB-H0603R121TR300F](#) [NCB-](#)  
[H0805A220TR600F](#) [NCB-H1206B601TR200F](#) [CIM21J252NE](#) [EMI0805R-220](#) [74279250](#)