

■ Features

- SMD construction, and low profile.
- High Impedance and Excellent Frequency Characteristic.
- Self Electromagnetic Shielding.
- Low Magnetic Flux Leakage.

■ Applications

- LED Light, TV game, Monitor, etc.
- EMI common-mode noise.

■ Product Identification

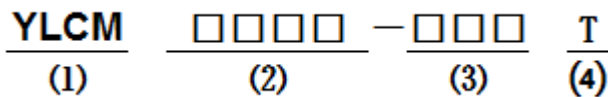

- (1) : Type
- (2) : Dimensions
- (3) : Inductance Value
- (4) : Taping

■ Shapes and Dimensions (Unit: mm)

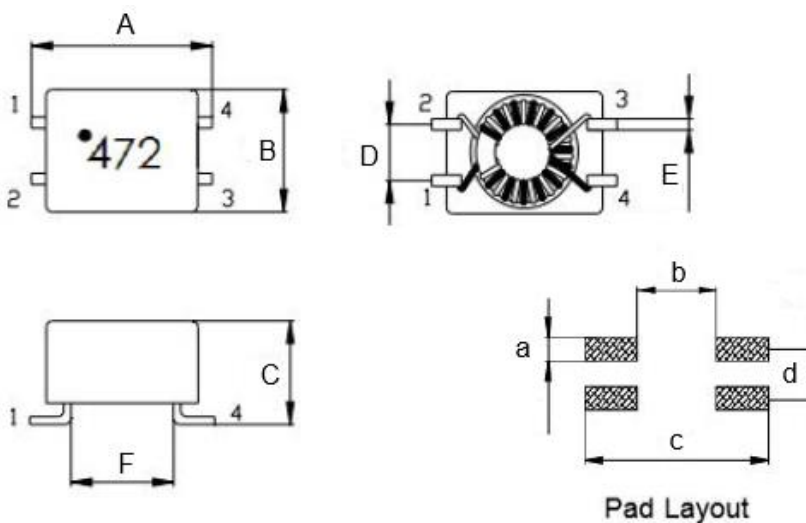

TYPE	A Max.	B Max.	C Max.	D Typ.	E Typ.	F Typ.	a Typ.	b Typ.	c Typ.	d Typ.
YLCM0904	9.50	5.60	5.20	2.54	0.50	5.50	1.00	4.50	10.50	2.54

■ Circuit Diagram

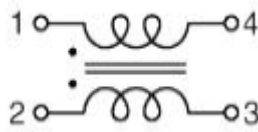

■ YLCM0904 Series

Part Number	Inductance +50%/-30% @100KHz/0.1V	Leakage Inductance L1-4(2-3short) @100KHz/0.1V	DC Resistance (mΩ)Max.	Current Rating (A)	Impedance (Ω)Min.	Freq. Range (MHz)	Rated Volt.(Vdc) Max.
YLCM0904-110T	11 uH	0.08 uH Typ	120	1.0	160	20-300	50V
YLCM0904-250T	25 uH	0.15 uH Typ	200	0.9	450	20-150	50V
YLCM0904-510T	51 uH	0.20 uH Typ	300	0.8	800	20-100	50V
YLCM0904-101T	100 uH	0.25 uH Typ	100	0.7	600	3-20	50V
YLCM0904-471T	470 uH	0.28 uH Typ	280	0.7	1200	2-15	50V
YLCM0904-102T	1000 uH	0.28 uH Typ	300	0.7	1800	1-10	50V
YLCM0904-222T	2200 uH	0.29 uH Typ	400	0.5	3000	0.8-5	50V
YLCM0904-472T	4700 uH	0.30 uH Typ	700	0.4	5000	0.5-3	50V

1. Rated Current: Temp.rise 40°C Typ
2. Operating Temperature: -40°C up to +85°C
- 3.Storage Temperature: -40°C up to +85°C

■ Material List

NO.	ITEM	DESCRIPTION	SUPPLIER
1	CORE	FERRITE	FENGYIN OR EQ
2	CASE	PM-9630	SHUO CHENG OR EQ
3	WIRE	P180 Grd1	ELEKTRISOLA OR EQ
4	ADHESIVE	XNR3614	CHANGLAI OR EQ
5	TIN	107H	SHENMAO OR EQ
6	INK	WHITE	BON MARQUE OR EQ

Reliability Testing

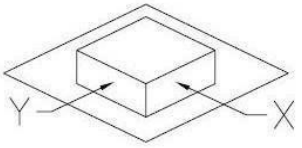
Operating Temperature	- 40 to + 85 °C (Contain Heating coil)
Appearance Inspection	No external defects by visual inspection
Terminal Strength 	After soldering , between copper plaet and terminals of coils , push in two directions of X , Y with standing 10N(1.02kg) for10+/-2 sec. Terminal should not peel off. (Refer to figure at right)
Heat endurance of reflow soldering	Refer to figure
Insulating resistance	Over 100 MΩ at 100V D.C . between wire and core .
Dielectric Strength	Apply at 0.5KV 3mA for 1 minute between wire and core .
Temperature characteristics	Inductance coefficient (0~2,000) × 10 / °C (- 20 ~ + 80 °C)
Humidity characteristics	Inductance deviation within ± 10% , after 96 hours in 90~95% relative humidity at 40 ± 2 °C and 1 hours drying under normal condition .

A test is made under the above mentioned condition , and it is kept for 2 hours in the normal

Recommended soldering temp.Graph

IR Reflow profile

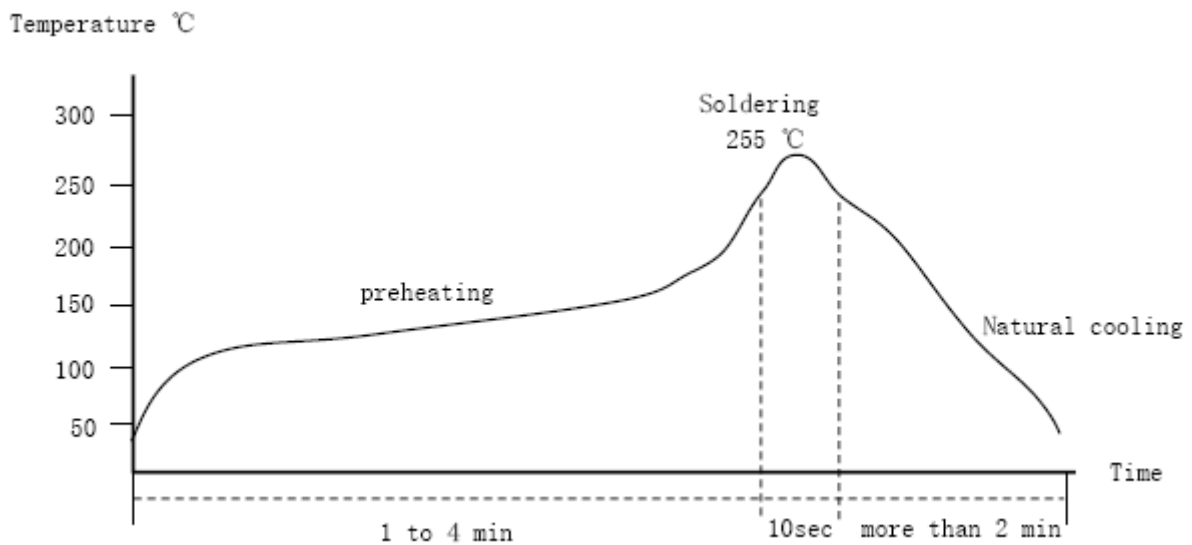

Temperature and humidity. After that,no mechanical and electrical defect should be found.

■ Taping Dimensions(Unit:mm)

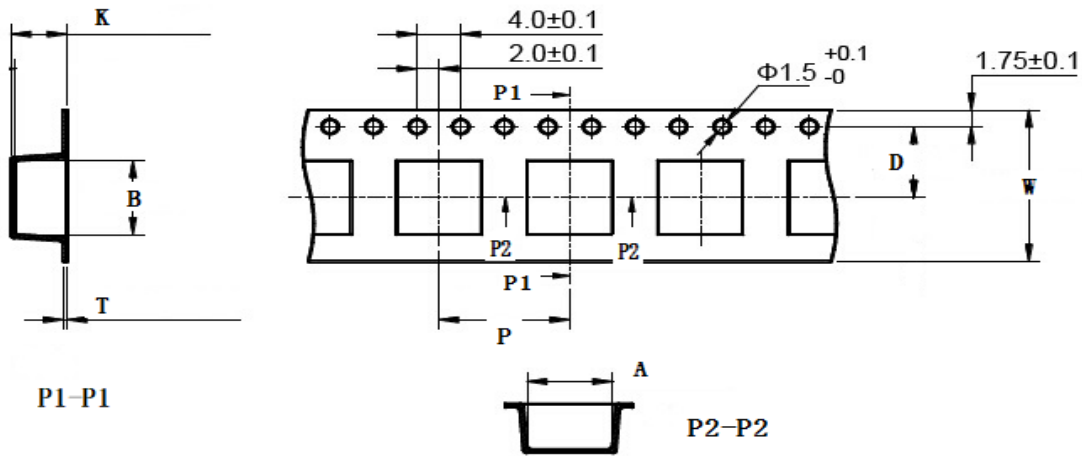

TYPE	W	A	B	D	P	K	T	MPQ
YLCM0904	16.0±0.3	6.4±0.3	6.4±0.1	7.5±0.1	8.0±0.1	5.0±0.1	0.40±0.05	1500

■ Reel Dimensions(Unit:mm)



TYPE	W	W1	A	B	C	D
YLCM0904	330±2.0	24.4±1.5	30.4MAX	23.9 Min	13.0±0.50	21.0±0.80

Direction of rolling

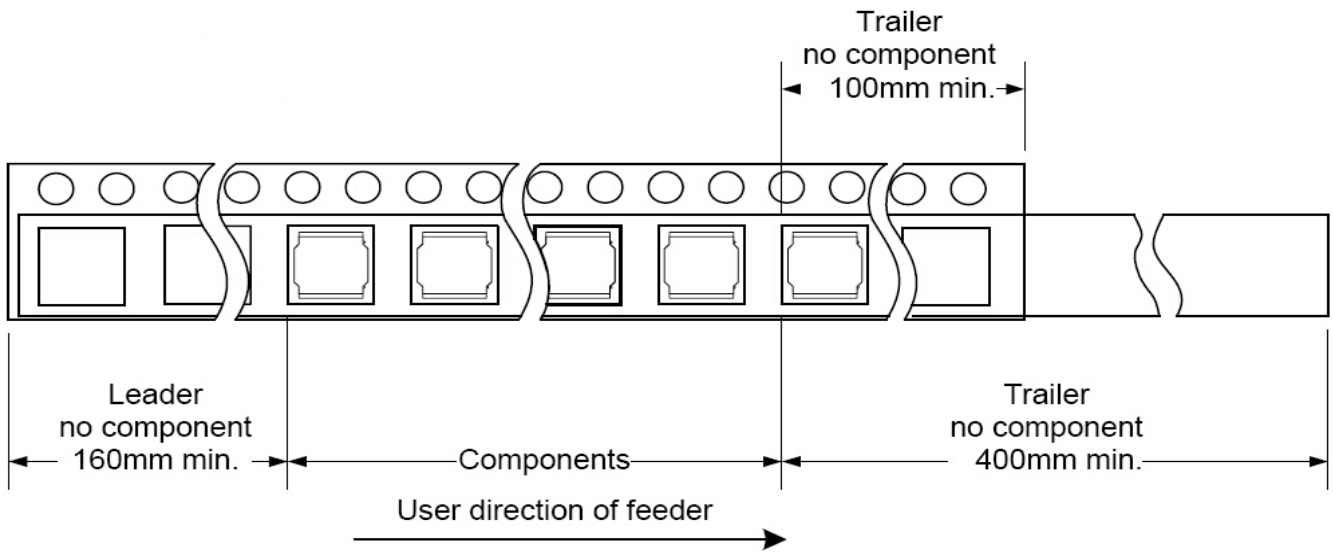

Cover tape peel off condition

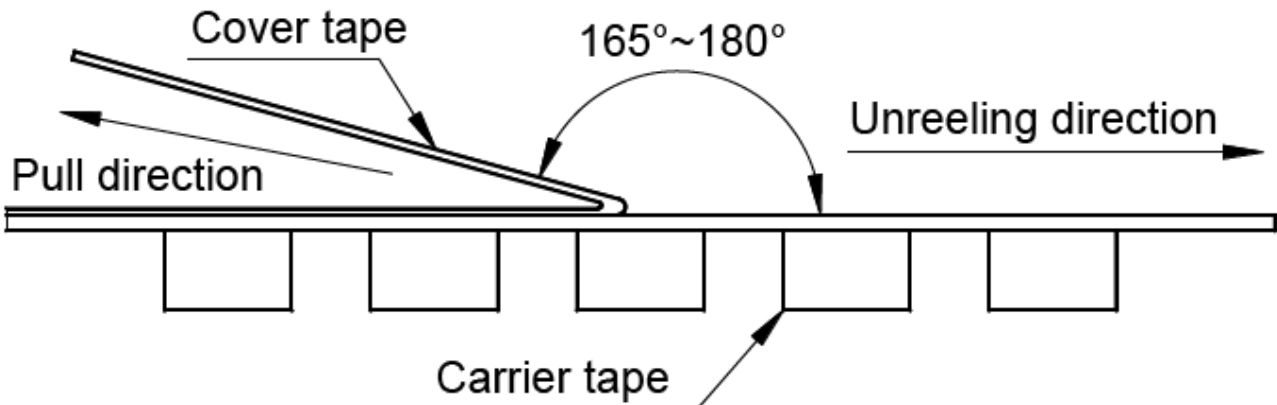

Cover tape peel force shall be 0.1N to 1.3N.

Reference peel speed 300±10mm/min.

X-ON Electronics

Largest Supplier of Electrical and Electronic Components

Click to view similar products for [Common Mode Chokes / Filters](#) category:

Click to view products by [YJYCOIN](#) manufacturer:

Other Similar products are found below :

[PE-64683](#) [ST6118T-R](#) [FE3X025-10-7NL](#) [T8114NLT](#) [TCM0806G-350-2P-T](#) [TCM0806G-650-2P-T](#) [IND-0110](#) [UAL21VR0802000](#)
[UALSC023000000](#) [UALSC1020JH000](#) [UALSU10VD20010](#) [UALSU9VD070100](#) [36-00037](#) [CM7060M132R-10](#) [UALW21HS072450](#)
[UALSU9H0208000](#) [UAL24VK06450CH](#) [PLT10HH501100PNB](#) [PLT10HH401100PNB](#) [PLT10HH1026R0PNB](#) [36-00029-01](#) [PE-67531](#)
[TLH10UB](#) [113 0R5](#) [2752045447](#) [CM8663Z161B-10](#) [7351V](#) [CMF16-153131](#) [T8116NLT](#) [CMS2-10-R](#) [FE2X10-4-2NL](#) [T8003NLT](#) [CTX01-](#)
[13663](#) [CTX66-19521-R](#) [RC212-0.5-10M](#) [RC112-0.4-15M](#) [RC212-0.6-6M8](#) [RC212-0.4-15M](#) [RC112-0.3-30M](#) [4534-3](#)
[WTCF2012Z0M751PB](#) [PH9408.814NLT](#) [B82498B3221J000](#) [PAC6006.364NLT](#) [PAC6006.444NLT](#) [PAC6006.204NLT](#) [PH9407.204NLT](#)
[PAC6006.264NLT](#) [PH9408.105NLT](#) [PH9408.494NLT](#) [PAC6006.104NLT](#)