

■ Features

- SMD construction, and low profile.
- High Impedance and Excellent Frequency Characteristic.
- Self Electromagnetic Shielding.
- Low Magnetic Flux Leakage.

■ Applications

- LED Light, TV game, Monitor, etc.
- EMI common-mode noise.

■ Product Identification

$\frac{\text{YLM}}{(1)} \quad \frac{\square\square\square\square}{(2)} - \frac{\square\square\square}{(3)} \quad \frac{\text{T}}{(4)}$

(1) : Type

(2) : Dimensions

(3) : Inductance value

(4) : Taping

Shapes and Dimensions (Unit: mm)

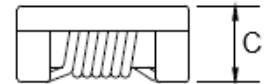
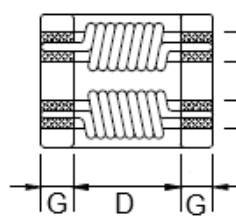
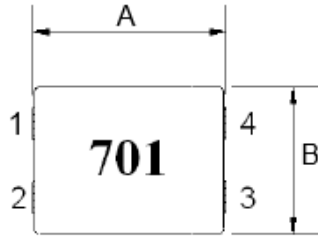
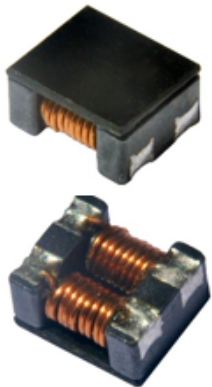

TYPE	A	B	C Max	D Typ	E	F	G
YLM7060	7.0±0.5	6.0±0.5	3.8	3.5	1.5±0.5	1.5±0.5	1.7±0.5

Circuit Diagram

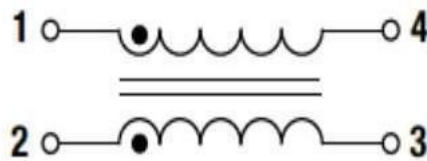

YLM7060 Series

Part Number	Z (Ω) @100MHz/0.1V		DC Resistance (mΩ) Max.	Rated Current (A) max.	Rated Volt. (V)max.	IR(MΩ) min.	Marking
	Min	Typ					
YLM7060-400T	40	70	5	15.0	125	10	400
YLM7060-101T	100	140	10	9.0	125	10	101
YLM7060-301T	225	300	10	5.0	125	10	301
YLM7060-501T	275	350	10	5.0	125	10	501
YLM7060-601T	500	700	15	4.0	125	10	601
YLM7060-701T	500	700	15	4.0	125	10	701
YLM7060-102T	800	1020	17	3.0	125	10	102
YLM7060-132T	910	1300	21	2.5	125	10	132
YLM7060-272T	2000	2700	63	1.0	125	10	272
YLM7060-302T	2500	3000	75	0.9	125	10	302

Material List

NO.	ITEM	DESCRIPTION	SUPPLIER
1	CORE	FERRITE	SINCORES OR EQ
2	WIRE	2UEW P180	ELEKTRISOLA OR EQ
3	BASE	LCP	LIANGCHENG OR EQ
4	SOLDER	Sn Cu	SHENMAO OR EQ
5	EPOXY	ME-5890	PENGNO OR EQ
6	INK	WHITE	BON MARK

Reliability Testing

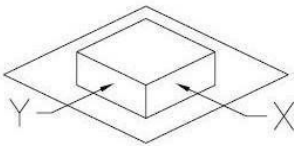
Operating Temperature	- 30 to + 100 °C (Contain Heating coil)
Appearance Inspection	No external defects by visual inspection
Terminal Strength 	<p>After soldering , between copper plaet and terminals of coils , push in two directions of X , Y with standing 10N(1.02kg) for10+/-2 sec.</p> <p>Terminal should not peel off. (Refer to figure at right)</p>
Heat endurance of reflow soldering	Refer to figure
Insulating resistance	Over 100 MΩ at 100V D.C . between wire and core .
Dielectric Strength	Apply at 0.5KV 3mA for 1 minute between wire and core .
Temperature characteristics	Inductance coefficient (0~2,000) × 10 / °C(- 30 ~ + 100 °C)
Humidity characteristics	Inductance deviation within ± 10% , after 96 hours in 90~95% relative humidity at 40 ± 2 °C and 1 hours drying under normal condition .
A test is made under the above mentioned condition , and it is kept for 2 hours in the normal	

Recommended soldering temp.Graph

IR Reflowprofile

Temperature °C

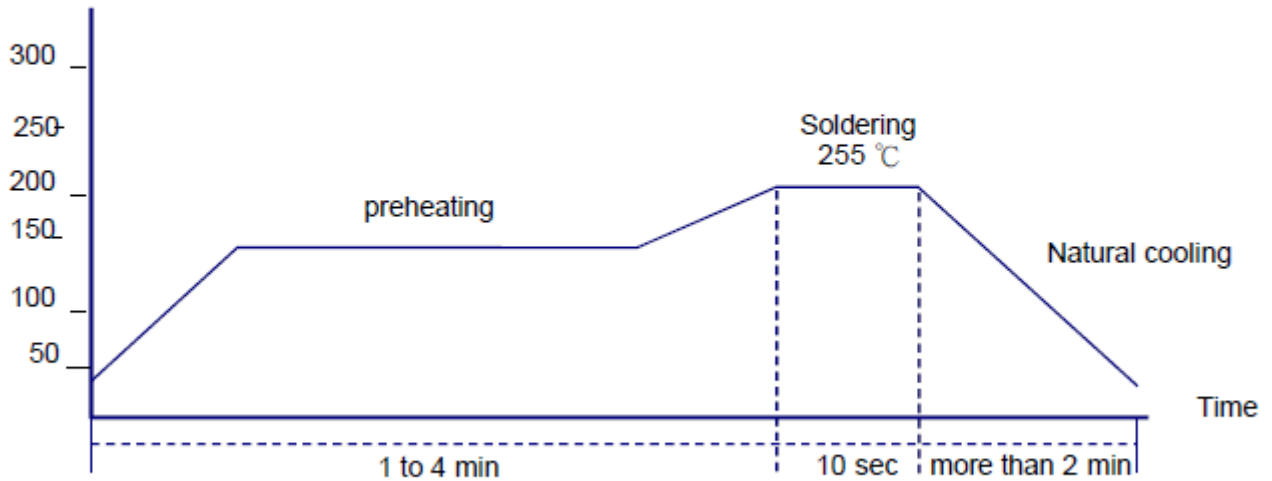

Temperature and humidity . After that , no mechanical and electrical defect should be found .

Taping Dimensions(Unit:mm)

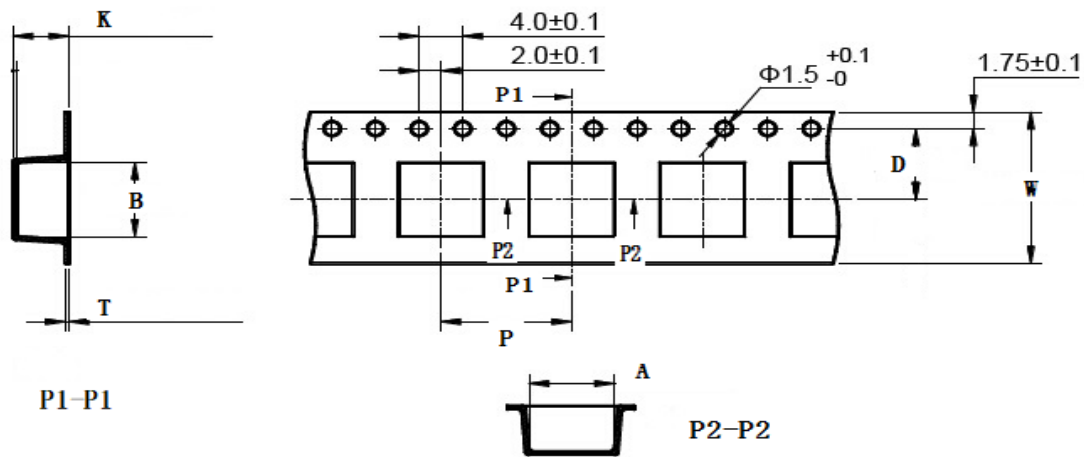

TYPE	W	A	B	D	P	K	T	MPQ
YLM7060	16.0±0.3	6.9±0.3	8.4±0.3	7.5±0.1	12±0.1	4.2±0.1	0.40±0.05	1500

Reel Dimensions(Unit:mm)

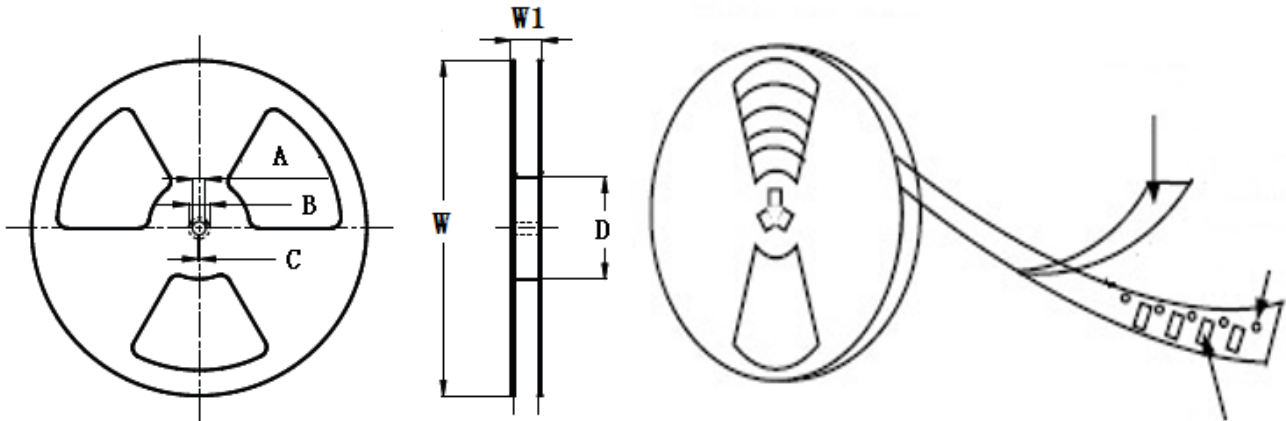

TYPE	W	W1	A	B	C	D
YLM7060	330±2.0	16.4±2.0	13.0±0.50	21.0±0.80	2.0±0.50	100Min

Direction of rolling

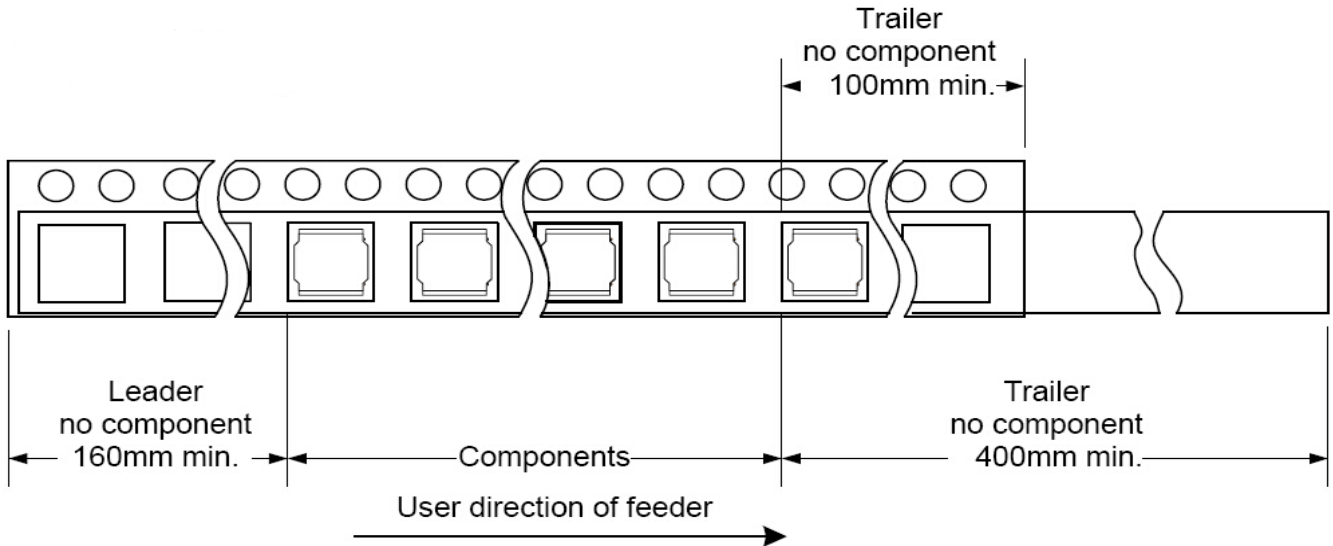

■ Cover tape peel off condition

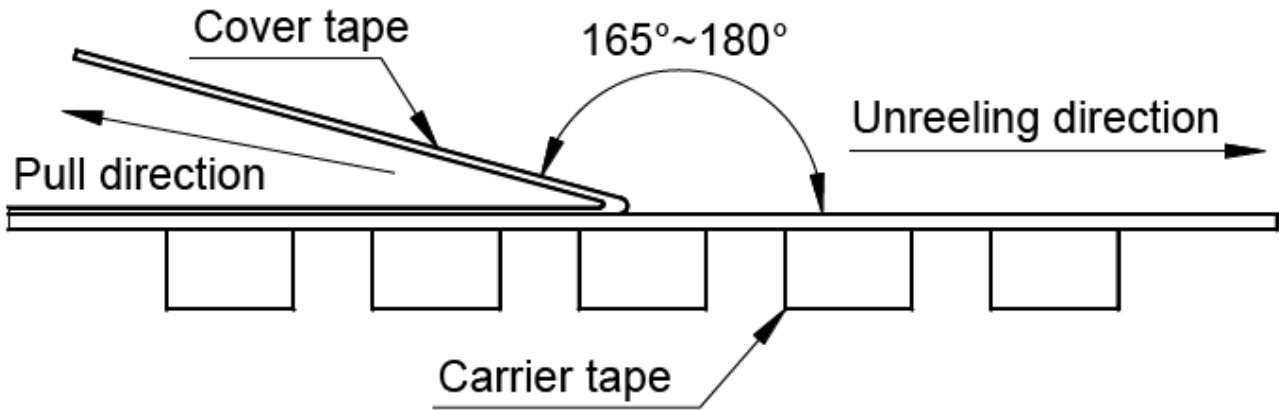

Cover tape peel force shall be 0.1N to 1.3N.

Reference peel speed 300±10mm/min.

X-ON Electronics

Largest Supplier of Electrical and Electronic Components

Click to view similar products for [Common Mode Chokes / Filters](#) category:

Click to view products by [YJYCOIN](#) manufacturer:

Other Similar products are found below :

[74279408](#) [PE-62911NL](#) [PE-64683](#) [RD5122-6-9M6](#) [RGCMF1210900H3T](#) [ST6118T-R](#) [FE3X025-10-7NL](#) [T8114NLT](#) [RD5122-10-6M0](#)
[TCM0806G-350-2P-T](#) [TCM0806G-650-2P-T](#) [IND-0110](#) [UAL21VR0802000](#) [UALSC023000000](#) [UALSC1020JH000](#) [UALSC1520JH000](#)
[UALSU10VR15019](#) [UALSU9VD070100](#) [36-00037](#) [5701610000](#) [UALW21HS200290](#) [UALW21HS072450](#) [UALSU9HF050500](#)
[UALSU9H0208000](#) [UAL24VK06450CH](#) [PLT10HH501100PNB](#) [PLT10HH401100PNB](#) [PLT10HH1026R0PNB](#) [PE-67531](#) [TLH10UB 113](#)
[OR5](#) [2752045447](#) [CMS3-11-R](#) [7351V](#) [7408-RC](#) [CMF16-153131](#) [744252510](#) [T8116NLT](#) [CMS2-10-R](#) [DLW44SN101SK2L](#) [FE2X10-4-2NL](#)
[744253200](#) [744253101](#) [744252220](#) [TX8111NLT](#) [UAL30VR3500470](#) [CTX01-19077-R](#) [T8003NLT](#) [CTX01-13663](#) [CTX66-19521-R](#)
[7446630047](#)