

■ Features

- Low profile construction and miniature size.
- Magnetic shielded construction.
- High current saturation.
- Operating temperature:-40°C ~ +125°C.
- RoHS compliant

■ Applications

- For small DC/DC converter(HDD,DVC,DSC,PDA,LCD display etc.).
- Car navigation systems,telecom base stations.
- VR,AR,LED lighting.

■ Product Identification

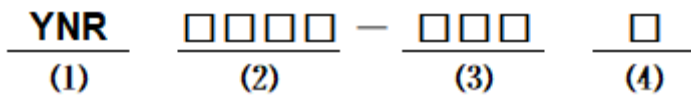

(1) : Type

(2) : Dimensions

(3) : Inductance value

(4) : Inductance Tolerance; N=±30%,M=±20%, K=±10%

■ Shapes and Dimensions (Unit: mm)

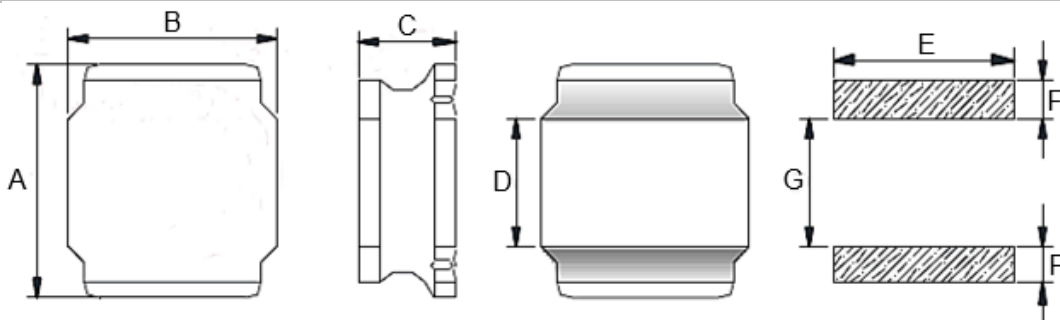

TYPE	A	B	C Max.	D	E Ref.	F Ref.	G Ref.
YNR2016	2.0±0.2	1.6±0.2	1.05	0.80±0.2	1.60	0.70	0.70

■ YNR2016 Series

Part Number	Inductance (uH) @100KHz	DC Resistance (Ω)		Heat Rating Current (A)	Saturation Current (A)
		Typ.	Max.		
YNR2016-R24□	0.24	0.033	0.040	2.80	3.70
YNR2016-R33□	0.33	0.041	0.048	2.40	3.00
YNR2016-R47□	0.47	0.050	0.060	2.30	2.30
YNR2016-R68□	0.68	0.063	0.076	2.00	1.95
YNR2016-1R0□	1.00	0.096	0.114	1.45	1.65
YNR2016-1R5□	1.50	0.145	0.174	1.10	1.35
YNR2016-2R2□	2.20	0.215	0.265	1.05	1.20
YNR2016-3R3□	3.30	0.290	0.345	0.85	1.00
YNR2016-4R7□	4.70	0.400	0.480	0.70	0.75
YNR2016-6R8□	6.80	0.610	0.800	0.55	0.70
YNR2016-8R2□	8.20	0.730	0.940	0.53	0.68
YNR2016-100□	10.0	0.800	1.000	0.50	0.65
YNR2016-120□	12.0	1.100	1.430	0.36	0.62
YNR2016-150□	15.0	1.300	1.700	0.30	0.50
YNR2016-220□	22.0	1.400	1.700	0.32	0.30

- ※ The saturation current value is the DC current value having inductance decrease down to 30%.(at 20°C)
- ※ The temperature rise current value is the DC current value having temperature increase up to 40°C. (at 20°C)
- ※ The rated current is the DC current value that satisfies both of current value saturation current value and temperature rise current value.

■ Taping Dimensions(Unit:mm)

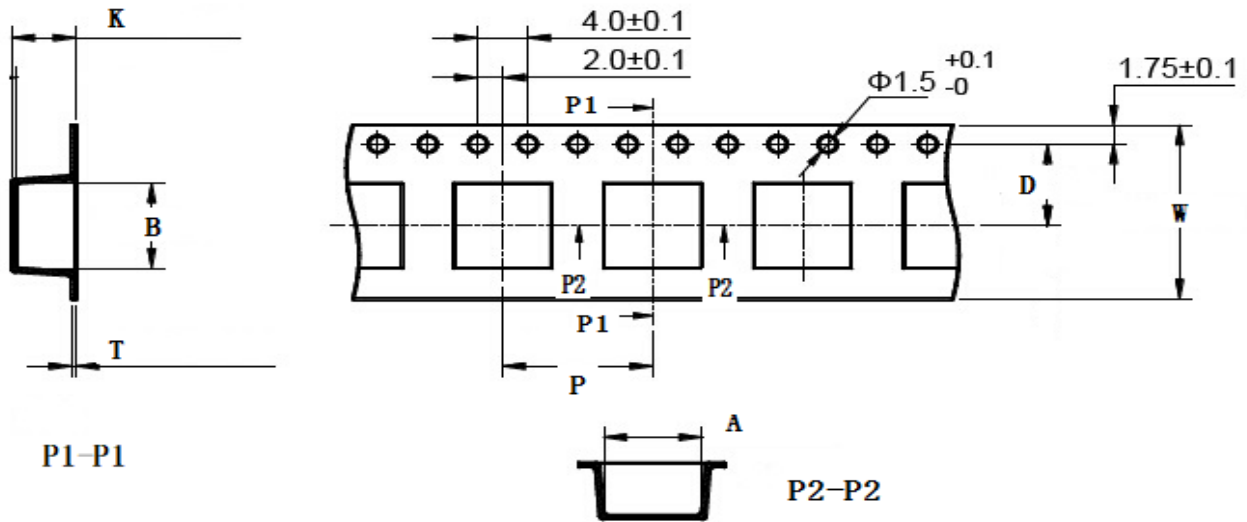

TYPE	Chip Thickness	W	A	B	D	P	K Max	T Max	MPQ
YNR2016	1.00	8.00	2.00	2.40	3.50	4.00	1.20	0.25	2000

■ Reel Dimensions(Unit:mm)

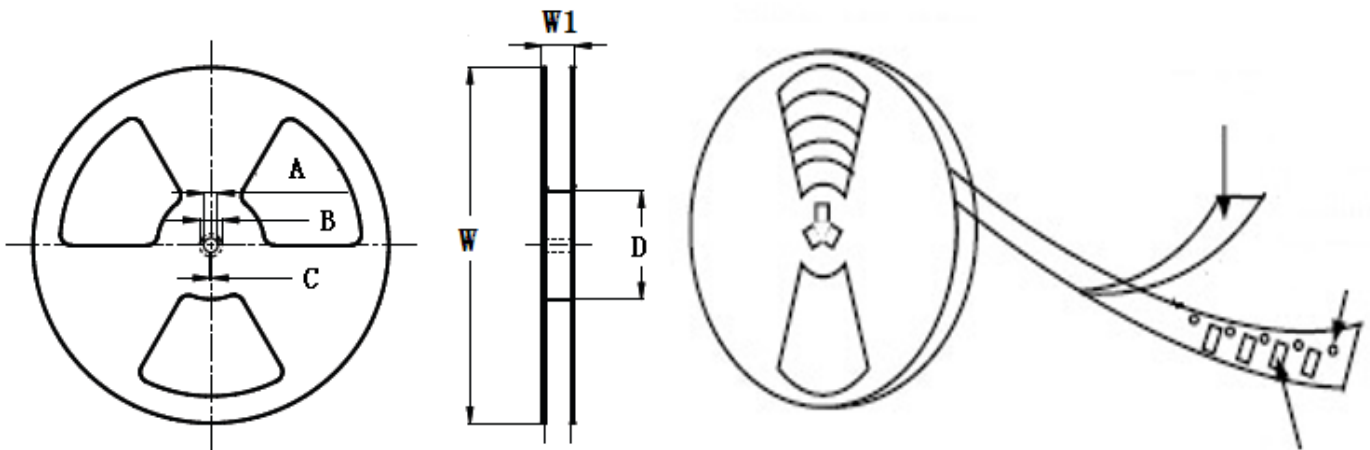

TYPE	W	W1	A	B	C	D
YNR2016	178±2.0	8.40±1.50	4.3±0.20	5.0±0.10	3.0±0.10	58±2.0

Direction of rolling



Cover tape peel off condition

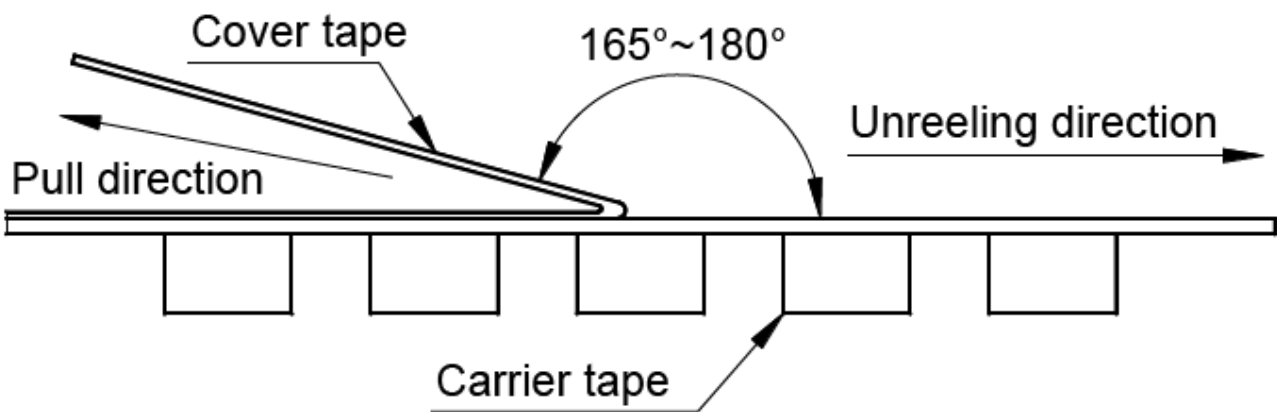

Cover tape peel force shall be 0.1N to 1.3N.

Reference peel speed 300±10mm/min.

X-ON Electronics

Largest Supplier of Electrical and Electronic Components

Click to view similar products for [Fixed Inductors](#) category:

Click to view products by [YJYCOIN](#) manufacturer:

Other Similar products are found below :

[CR32NP-151KC](#) [CR32NP-180KC](#) [CR32NP-181KC](#) [CR32NP-1R5MC](#) [CR32NP-390KC](#) [CR32NP-3R9MC](#) [CR32NP-680KC](#) [CR32NP-820KC](#) [CR32NP-8R2MC](#) [CR43NP-390KC](#) [CR43NP-560KC](#) [CR43NP-680KC](#) [CR54NP-181KC](#) [CR54NP-470LC](#) [CR54NP-820KC](#) [CR54NP-8R5MC](#) [70F224AI](#) [MGDQ4-00004-P](#) [MHL1ECTTP18NJ](#) [MHQ1005P10NJ](#) [MHQ1005P1N0S](#) [MHQ1005P2N4S](#) [MHQ1005P3N6S](#) [MHQ1005P5N1S](#) [MHQ1005P8N2J](#) [PE-51506NL](#) [PE-53601NL](#) [PE-53602NL](#) [PE-53630NL](#) [PE-53824SNLT](#) [PE-92100NL](#) [PG0434.801NLT](#) [PG0936.113NLT](#) [9220-20](#) [9310-16](#) [PM06-2N7](#) [PM06-39NJ](#) [A01TK](#) [1206CS-471XJ](#) [HC2LP-R47-R](#) [HC2-R47-R](#) [HC3-2R2-R](#) [HCF1305-3R3-R](#) [1206CS-151XG](#) [RCH664NP-140L](#) [RCH664NP-4R7M](#) [RCH8011NP-221L](#) [RCP1317NP-332L](#) [RCP1317NP-391L](#) [RCR1010NP-470M](#)