

■ Features

- Low profile construction and miniature size.
- Magnetic shielded construction.
- High current saturation.
- Operating temperature: -40°C ~ +125°C.
- RoHS compliant

■ Applications

- For small DC/DC converter(HDD,DVC,DSC,PDA,LCD display etc.).
- Car navigation systems,telecom base stations.
- VR,AR,LED lighting.

■ Product Identification

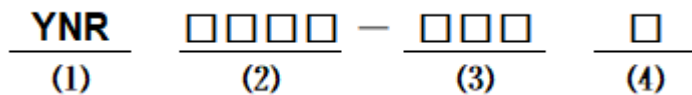

(1) : Type

(2) : Dimensions

(3) : Inductance value

(4) : Inductance Tolerance; N=±30%,M=±20%, K=±10%

■ Shapes and Dimensions (Unit: mm)

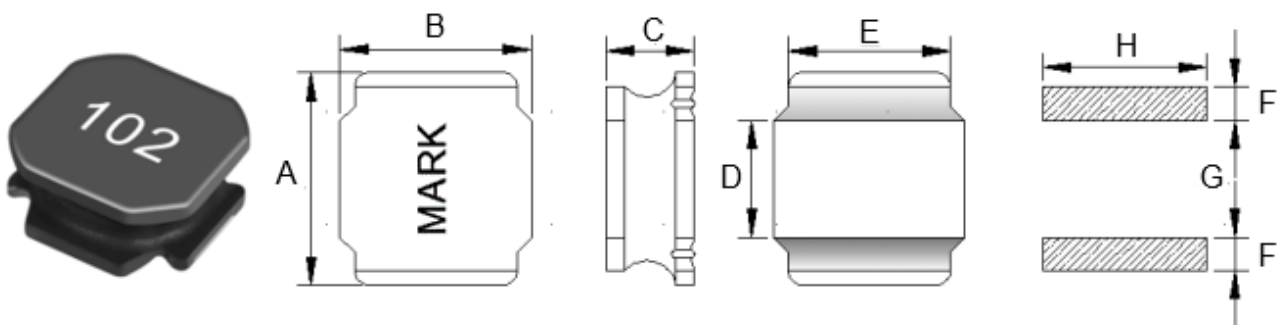

TYPE	A	B	C Max.	D	E Ref.	F Ref.	G Ref.	H Ref.
YNR4030	4.0±0.2	4.0±0.2	3.0	1.8±0.3	3.2	1.3	1.6	3.7

■ Electrical Characteristics List

Part Number	Inductance (uH)	Test Freq. (KHz/V)	DCR Max. (Ω)	Heat Rating Current (A)	Saturation Current (A)
YNR4030-501M	500 \pm 20%	100/0.25	9.027	0.15	0.28

- ※ The saturation current value is the DC current value having inductance decrease down to 30%.(at 20°C)
- ※ The temperature rise current value is the DC current value having temperature increase up to 40°C. (at 20°C)
- ※ The rated current is the DC current value that satisfies both of current value saturation current value and temperature rise current value.

■ Taping Dimensions(Unit:mm)

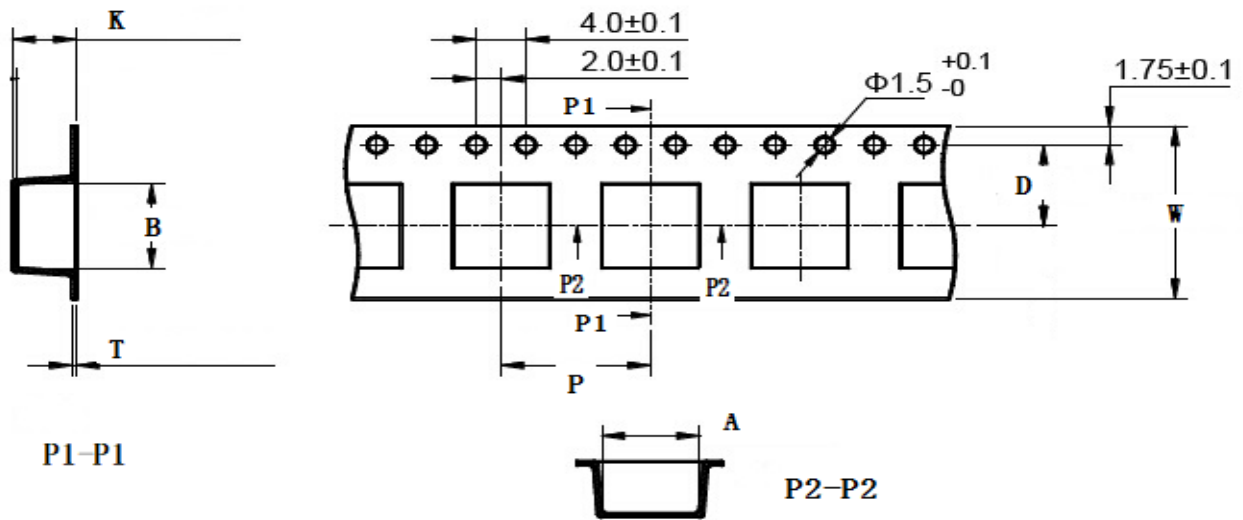

TYPE	Chip Thickness	W	A	B	D	P	K Max	T Max	MPQ
YNR4030	3.00	12.0	4.30	4.30	5.50	8.00	3.20	0.40	2000

■ Reel Dimensions(Unit:mm)

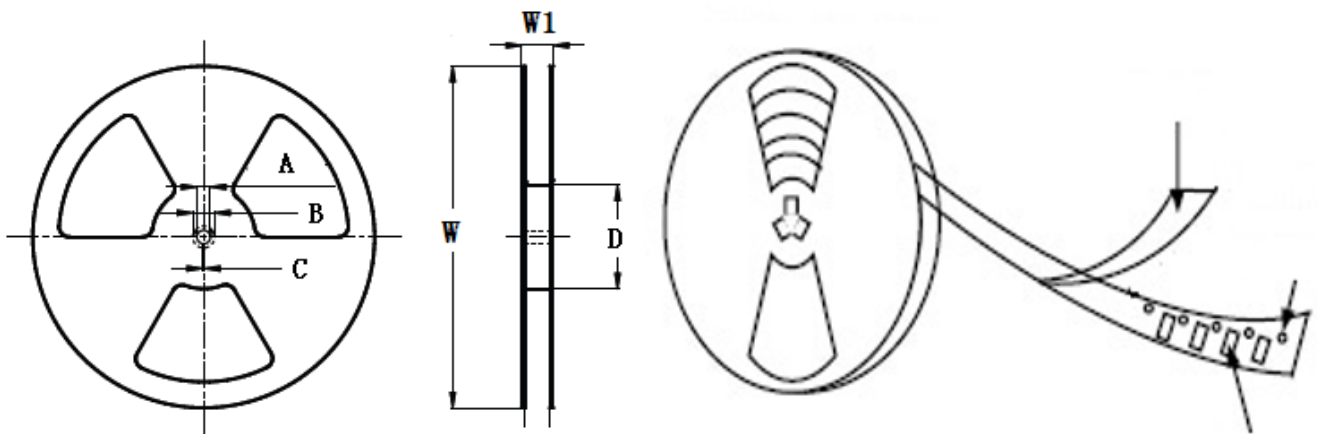

TYPE	W	W1	A	B	C	D
YNR4030	330±2.0	12.8±1.50	13.0±0.50	21.0±0.80	2.0±0.50	100 Min

Direction of rolling

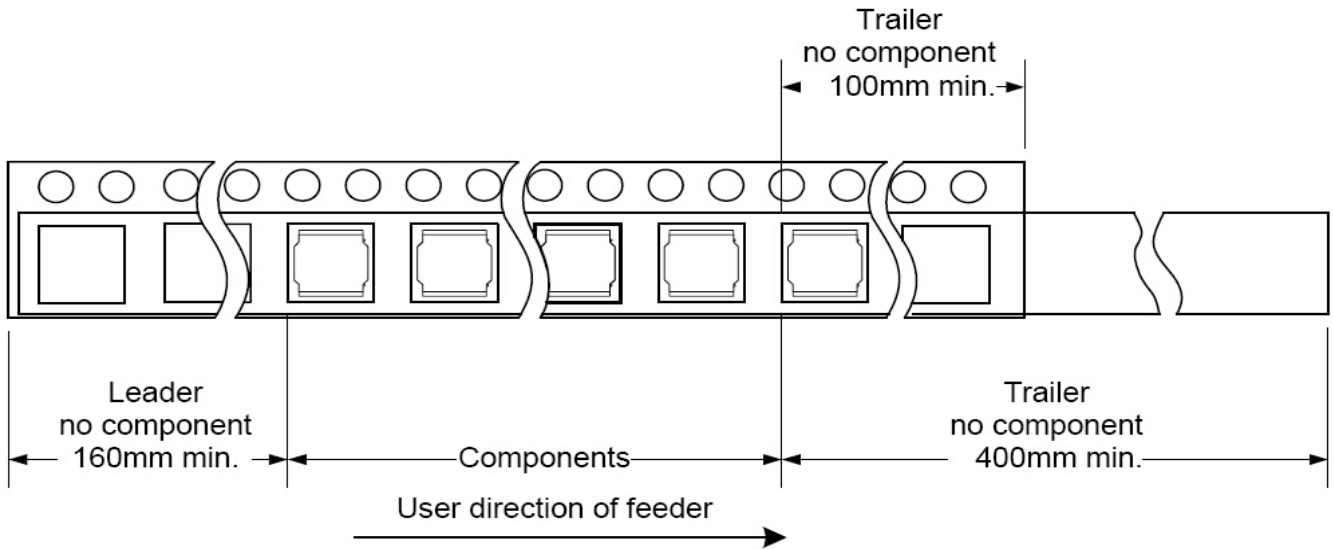

Cover tape peel off condition

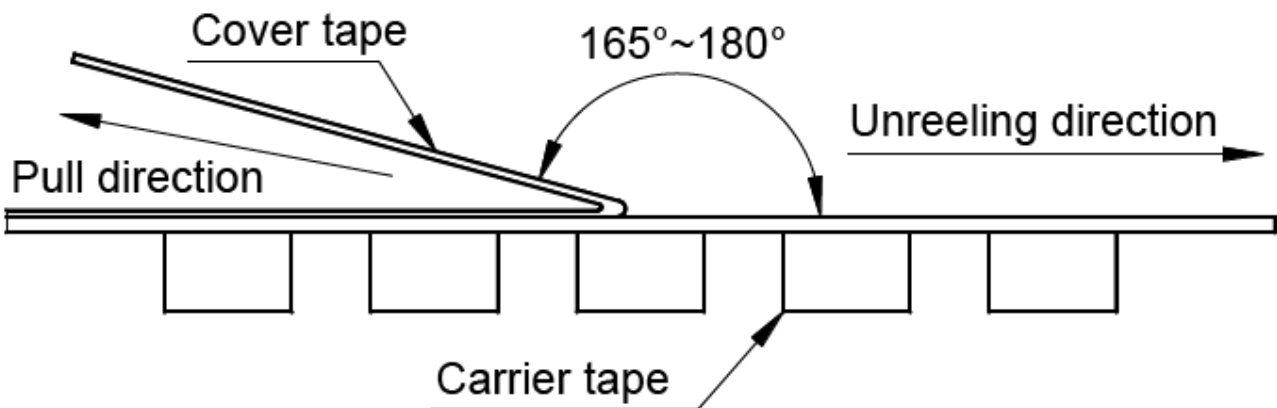

Cover tape peel force shall be 0.1N to 1.3N.

Reference peel speed 300±10mm/min.

X-ON Electronics

Largest Supplier of Electrical and Electronic Components

Click to view similar products for [Fixed Inductors](#) category:

Click to view products by [YJYCOIN](#) manufacturer:

Other Similar products are found below :

[CR32NP-100KC](#) [CR54NP-470LC](#) [70F224AI](#) [MGDQ4-00004-P](#) [MHQ1005P10NJ](#) [MHQ1005P1N0S](#) [MHQ1005P2N4S](#) [MHQ1005P3N6S](#)
[MHQ1005P5N1S](#) [MHQ1005P8N2J](#) [PE-53601NL](#) [PE-53602NL](#) [PG0936.113NLT](#) [9220-20](#) [9310-16](#) [PM06-2N7](#) [PM06-39NJ](#) [A01TK](#)
[1206CS-471XJ](#) [HC2-R47-R](#) [HC8-1R2-R](#) [HCF1305-3R3-R](#) [1206CS-151XG](#) [RCH664NP-140L](#) [RCH664NP-4R7M](#) [RCP1317NP-391L](#)
[RCR110DNP-331L](#) [DH2280-4R7M](#) [DS1608C-106](#) [B10TJ](#) [B82498B3101J000](#) [ELJ-RE27NJF2](#) [1812CS-153XJ](#) [1812CS-183XJ](#) [1812CS-](#)
[223XJ](#) [1812LS-104XJ](#) [1812LS-105XJ](#) [1812LS-124XJ](#) [1812LS-154XJ](#) [1812LS-223XJ](#) [1812LS-224XJ](#) [1812LS-563XJ](#) [1812LS-683XJ](#)
[1812LS-824XJ](#) [NIN-FB101JTR110F](#) [NIN-FB471JTR62F](#) [NIN-FC1R5JTR220F](#) [NIN-HCR15JTRF](#) [NIN-HCR33JTRF](#) [NIN-HDR22JTRF](#)