

■ Features

- Assemblage design, sturdy structure.
- High inductance, high current, low magnetic loss, low ESR, small parasitic capacitance.
- Flat wire winding, achieve alow D.C. Resistance.
- Temperature rise current and saturation current is less influenced by environment.
- Operating temperature range: -40°C ~ +125°C.

■ Applications

- Low profile, high current power supplies.
- Battery powered devices.
- DC/DC converters in distributed power systems.
- DC/DC converters for field programmable gate array.

■ Product Identification

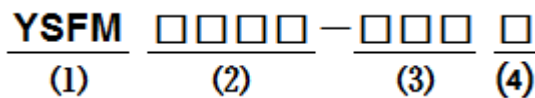

- (1) : Type
- (2) : Dimensions
- (3) : Inductance value
- (4) : Inductance Tolerance: M=±20%,K=±10%,J=±5%

■ Shapes and Dimensions (Unit: mm)

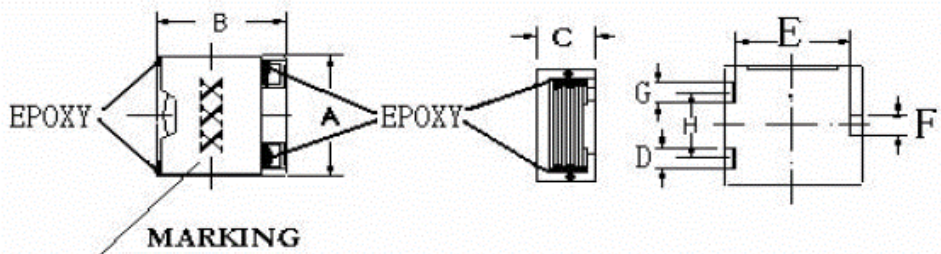

TYPE	A Max.	B Max.	C Max.	D	E Typ.	F	G	H
YSFM1480	14.9	15.0	8.1	2.8±0.2	10.5	2.3±0.2	2.8±0.2	9.0±0.5

Electrical requirements

Part Number	L (uH)	Test Freq.	DCR Max.(MΩ)	I sat (A)	I rms (A)
YSFM1480-R70M	0.7±20%	100KHz/0.25V	3.0	40	19
YSFM1480-1R8M	1.8±20%	100KHz/0.25V	3.9	30	18
YSFM1480-2R2M	2.2±20%	100KHz/0.25V	3.9	25	18
YSFM1480-3R1M	3.1±20%	100KHz/0.25V	3.9	18	18
YSFM1480-4R7M	4.7±20%	100KHz/0.25V	3.9	15	18
YSFM1480-6R1M	6.1±20%	100KHz/0.25V	8.0	15	12
YSFM1480-100M	10±20%	100KHz/0.25V	10.0	10	10
YSFM1480-150M	15±20%	100KHz/0.25V	10.0	8	10
YSFM1480-220M	22±20%	100KHz/0.25V	24.0	6	6

- ※ All test data is based on 25 °C ambient.
- ※ DC current(A) that will cause an approximate ΔT40°C.
- ※ DC current(A) that will cause L0 to drop approximately 25% Typ.
- ※ The part temperature (ambient + temp rise) should not exceed 125°C under worst case operating conditions. Circuit design,component.PWB trace size and thickness,airflow and other cooling provision all affect the part temperature.Part temperature should be verified in the den application.

Electrical schematics

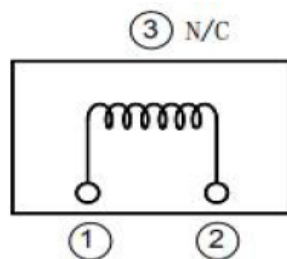

Recommended PCB layout

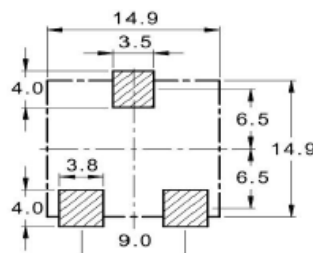

Current characteristic

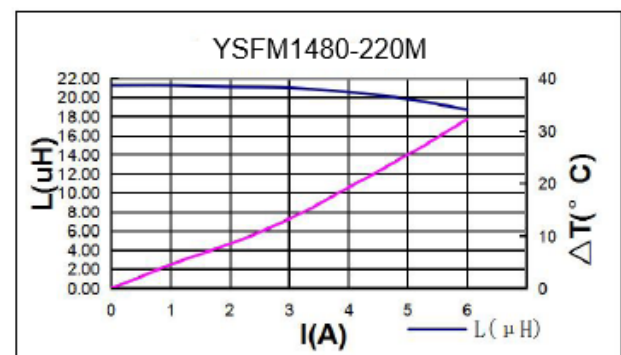
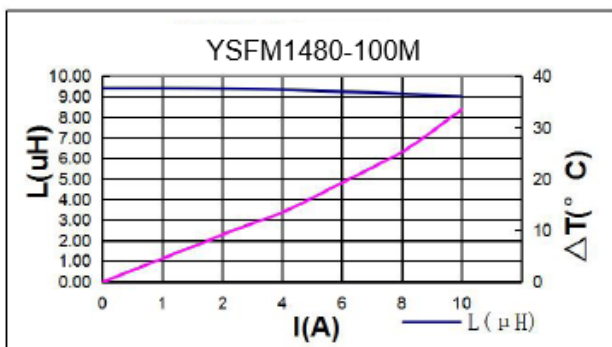
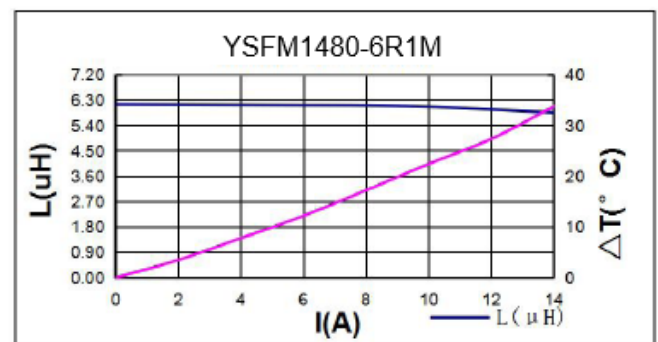
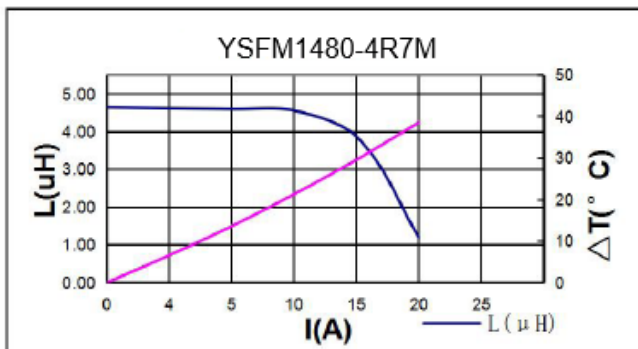
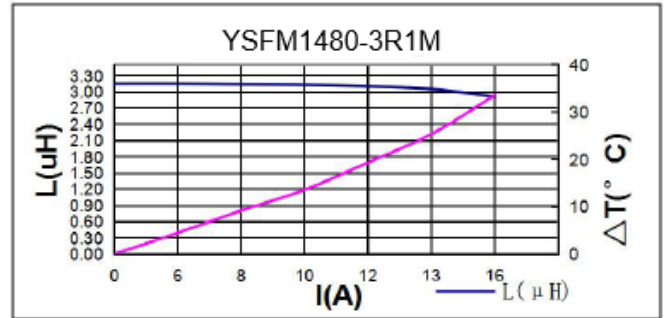
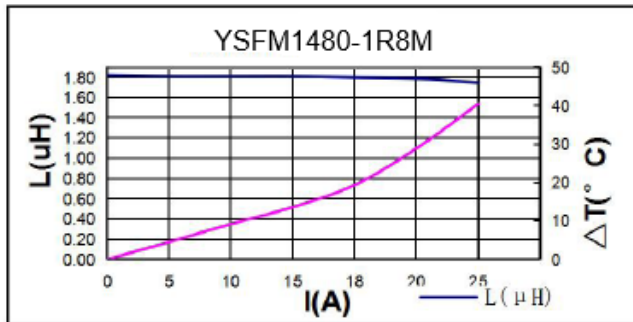

■ Reliability

Item	Specification and Requirement	Test Method
Solder ability test	Terminals area must have 95% min solder coverage	Solder heat proof: ① Preheating: $160 \pm 10^{\circ}\text{C}$ for 90 seconds ② Retention time: $245 \pm 5^{\circ}\text{C}$ for 2 ± 0.5 seconds
Vibration test	Inductance change: Within $\pm 5\%$ Without Mechanical damage such as break	① Vibration frequency: (10Hz to 55Hz to 10Hz) in 60 seconds as a period ② Vibration time: Period cycled for 2 hours in each of 3 mutual perpendicular directions. ③ Amplitude: 1.5mm Max.
Shock test	Inductance change: Within $\pm 5\%$ Without Mechanical damage such as break	① Peak value: 100G. ② Duration of pulse: 11ms. ③ Times in each positive and negative direction of 3 mutual perpendicular directions
Thermal shock	Inductance change: Within $\pm 5\%$ Without Mechanical damage such as break	① Repeat 100 cycle as follow ($-55 \pm 2^{\circ}\text{C}$ 30 \pm 3 minutes), Room temperature, 5 minutes ($+125 \pm 2^{\circ}\text{C}$, 30 \pm 3 minutes) ② Recovery: 48+4/-0 hours of recovery Under the standard condition after the test. (see Note 1)
High temperature life test	Inductance change: Within $\pm 5\%$ Without Mechanical damage such as break	① Environment condition: $85 \pm 2^{\circ}\text{C}$ Applied current: Rated current ② Duration: 1000+4/-0 hours (see Note 1)
Humidity Resistance	Inductance change: Within $\pm 5\%$ Without Mechanical damage such as break	① Environment condition: $60 \pm 2^{\circ}\text{C}$ Humidity: 90-95% Applied current: Rated current ② Duration: 1000+4/-0 hours (see Note 1)
Low temperature life test	Inductance change: Within $\pm 5\%$ Without Mechanical damage such as break	Store temperature $-55 \pm 2^{\circ}\text{C}$ for total 1000+4/-0 hours
High temperature life test	Inductance change: Within $\pm 5\%$ Without Mechanical damage such as break	Store temperature $+125 \pm 2^{\circ}\text{C}$ for total 1000+4/-0 hours

Reflow Profile

Power Choke Coil Type

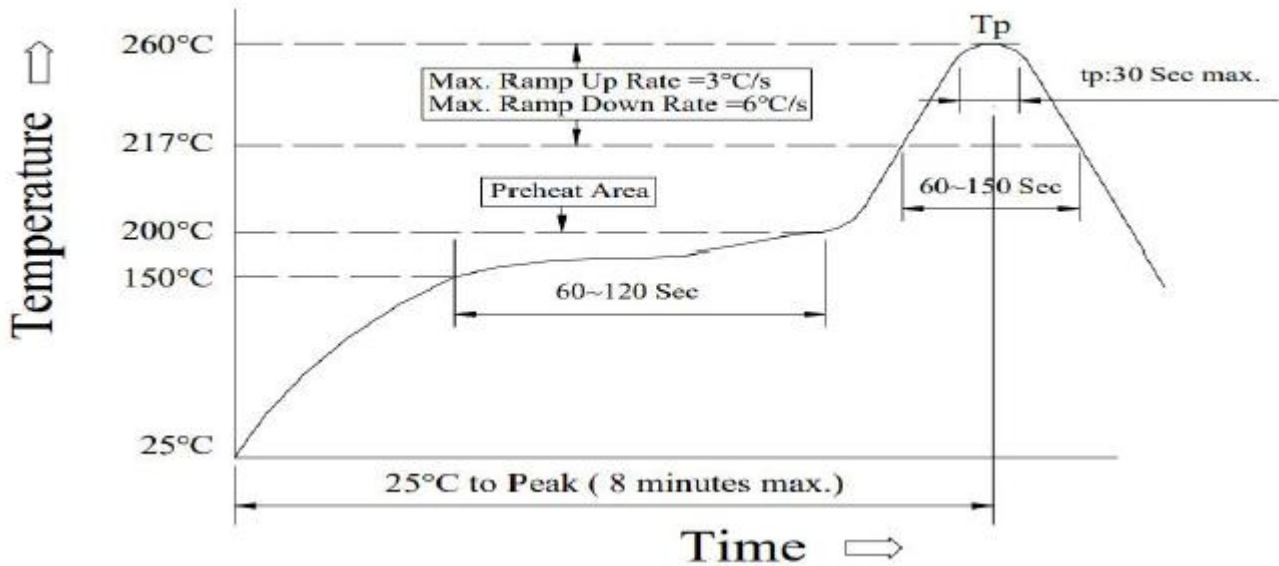

Reflow Soldering Method

Reflow Soldering	Tp:255 ~ 260°C Max. 30 seconds(tp)
	217°C 60 ~ 150 seconds
Pre-Heat	150 ~ 200°C 60 ~ 150 seconds
Time 25°C to peak temperature	8 minutes Max.

Soldering iron method

350±5°C Max.3 seconds.

■ Taping Dimensions(Unit:mm)

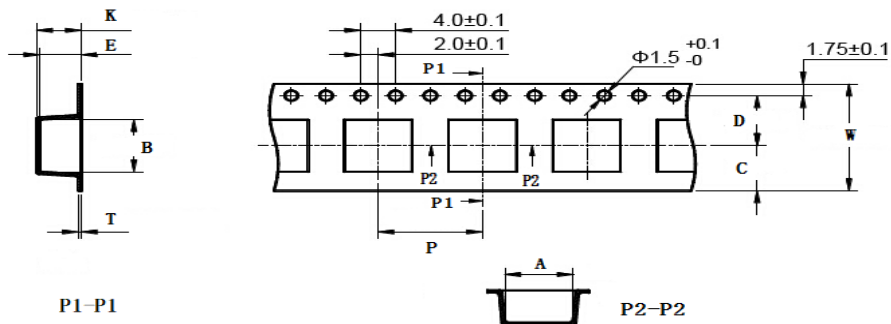

TYPE	W	A	B	C	D	E	P	K Ref	T	MPQ
YSFM1480	32±0.3	17.5±0.1	18.8±0.1	10.75	11.5±0.1	7.0±0.1	24±0.1	7.5	0.50±0.05	300

■ Reel Dimensions(Unit:mm)

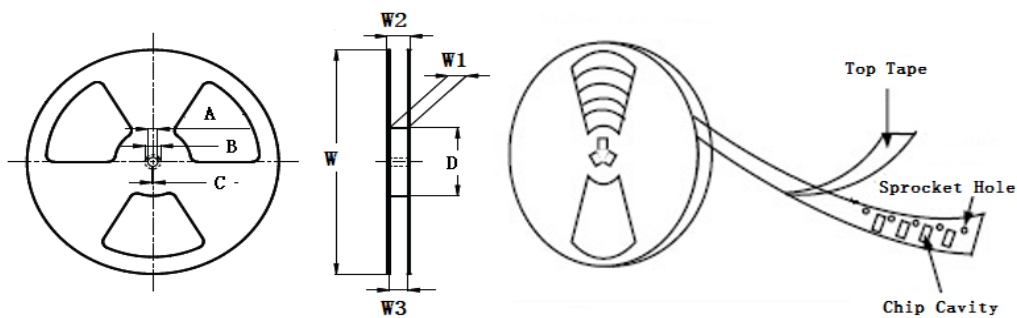

TYPE	W	W1	W2	W3	A	B	C	D
YSFM1480	330±2.0	32.5±1.5	30.4MAX	23.9 Min	13.0±0.50	21.0±0.80	2.0±0.50	100 Min

Direction of rolling

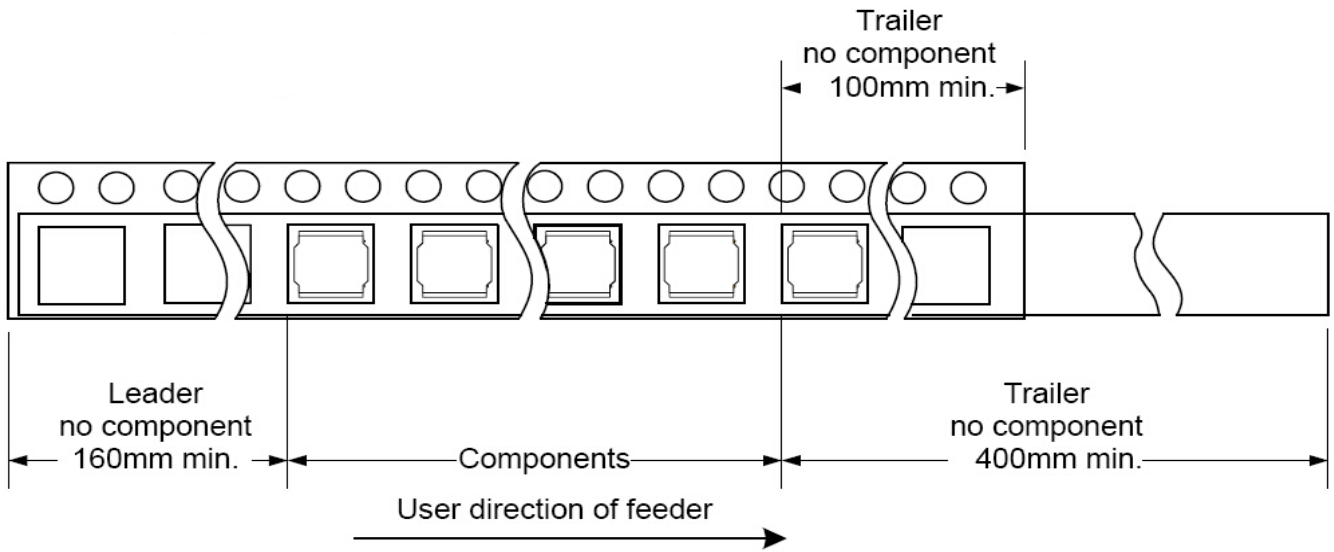

Cover tape peel off condition

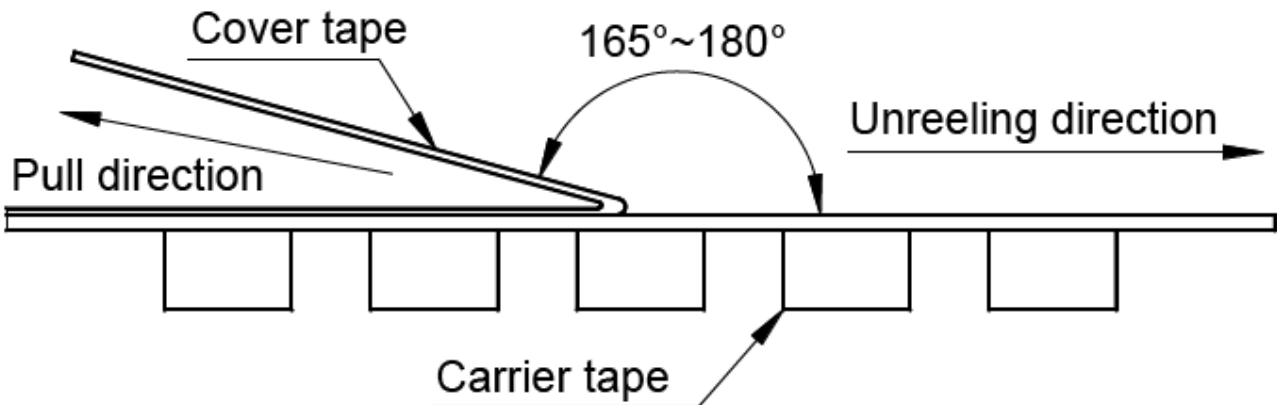

Cover tape peel force shall be 0.1N to 1.3N.

Reference peel speed 300±10mm/min.

X-ON Electronics

Largest Supplier of Electrical and Electronic Components

Click to view similar products for [Fixed Inductors](#) category:

Click to view products by [YJYCOIN](#) manufacturer:

Other Similar products are found below :

[CR32NP-100KC](#) [CR54NP-470LC](#) [70F224AI](#) [MGDQ4-00004-P](#) [MHQ1005P10NJ](#) [MHQ1005P1N0S](#) [MHQ1005P2N4S](#) [MHQ1005P3N6S](#)
[MHQ1005P5N1S](#) [MHQ1005P8N2J](#) [PE-53601NL](#) [PE-53602NL](#) [PG0936.113NLT](#) [9220-20](#) [9310-16](#) [PM06-2N7](#) [PM06-39NJ](#) [A01TK](#)
[1206CS-471XJ](#) [HC2-R47-R](#) [HC8-1R2-R](#) [HCF1305-3R3-R](#) [1206CS-151XG](#) [RCH664NP-140L](#) [RCH664NP-4R7M](#) [RCP1317NP-391L](#)
[RCR110DNP-331L](#) [DH2280-4R7M](#) [DS1608C-106](#) [B10TJ](#) [B82498B3101J000](#) [ELJ-RE27NJF2](#) [1812CS-153XJ](#) [1812CS-183XJ](#) [1812CS-](#)
[223XJ](#) [1812LS-104XJ](#) [1812LS-105XJ](#) [1812LS-124XJ](#) [1812LS-154XJ](#) [1812LS-223XJ](#) [1812LS-224XJ](#) [1812LS-563XJ](#) [1812LS-683XJ](#)
[1812LS-824XJ](#) [NIN-FB101JTR110F](#) [NIN-FB471JTR62F](#) [NIN-FC1R5JTR220F](#) [NIN-HCR15JTRF](#) [NIN-HCR33JTRF](#) [NIN-HDR22JTRF](#)