

**■ Features**

- Assemblage design, sturdy structure.
- High inductance, high current, low magnetic loss, low ESR, small parasitic capacitance.
- Flat wire winding, achieve a low D.C. Resistance.
- Temperature rise current and saturation current is less influenced by environment.
- Operating temperature range: -40°C ~ +125°C.

**■ Applications**

- Low profile, high current power supplies.
- Battery powered devices.
- DC/DC converters in distributed power systems.
- DC/DC converters for field programmable gate array.

**■ Product Identification**

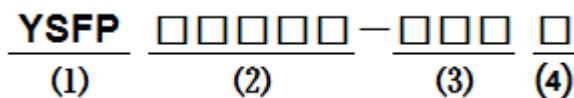

- (1) : Type
- (2) : Dimensions
- (3) : Inductance value
- (4) : Inductance Tolerance: M=±20%, K=±10%, J=±5%

**■ Shapes and Dimensions (Unit: mm)**

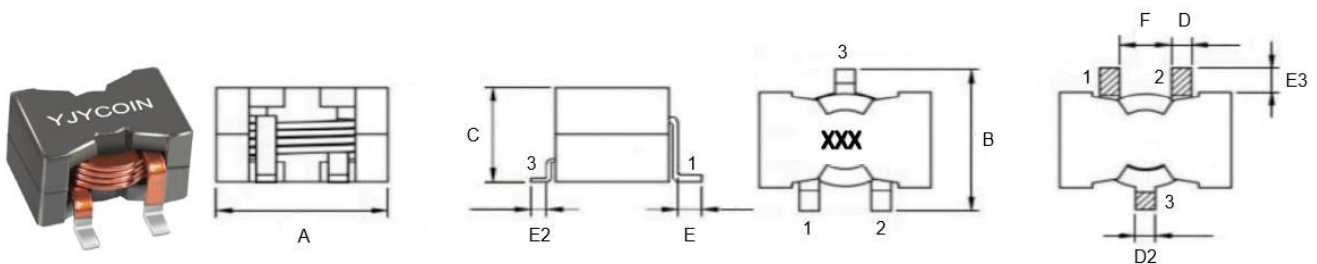

TYPE	A Max.	B Max.	C Max.	D	D2.	E	E2	E3	F
YSFP2014S	21.5	22.5	14.5	3.0±0.5	2.5±0.5	3.0±0.5	1.8±0.5	4.0~6.5	7.0±0.5

## ■ Electrical requirements

Part Number	L (uH)	Test Freq.	DCR Max.(mΩ)	I sat (A)	I rms (A)
YSFP2014S-2R2M	2.2±20%	100KHz/0.25V	2.3	55	28
YSFP2014S-2R7M	2.7±20%	100KHz/0.25V	2.3	48	28
YSFP2014S-3R1M	3.1±20%	100KHz/0.25V	2.3	48	28
YSFP2014S-4R7M	4.7±20%	100KHz/0.25V	2.4	35	23
YSFP2014S-6R8M	6.8±20%	100KHz/0.25V	2.4	29	23
YSFP2014S-100M	10±20%	100KHz/0.25V	7.0	23	18
YSFP2014S-150M	15±20%	100KHz/0.25V	9.5	18	16
YSFP2014S-220M	22±20%	100KHz/0.25V	9.5	13	16
YSFP2014S-330M	33±20%	100KHz/0.25V	9.5	9	16

- ※ All test data is based on 25 °C ambient.
- ※ DC current(A) that will cause an approximate ΔT40°C.
- ※ DC current(A) that will cause L0 to drop approximately 30% Typ.
- ※ The part temperature (ambient + temp rise) should not exceed 125°C under worst case operating conditions.  
Circuit design,component.PWB trace size and thickness,airflow and other cooling provision all affect the part temperature.Part temperature should be verified in the den application.

## ■ Electrical schematics

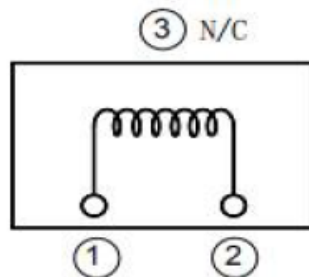

## ■ Recommended PCB Layout

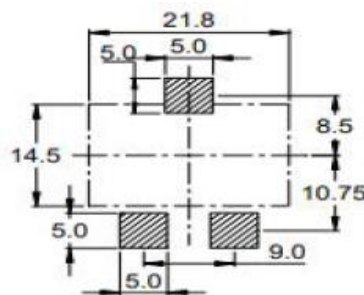

**Saturation current VS temperature rise current curve**

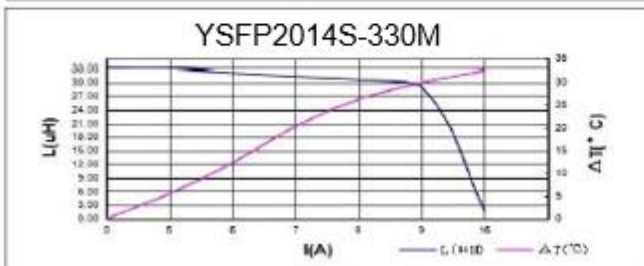
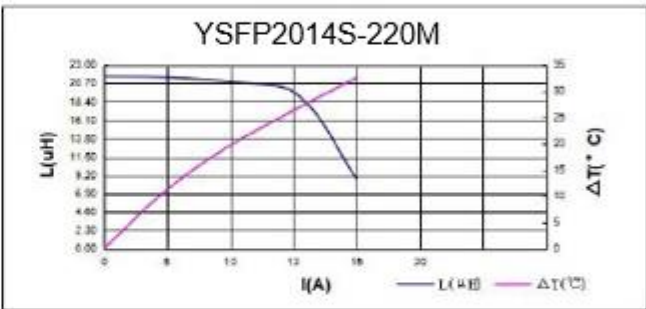
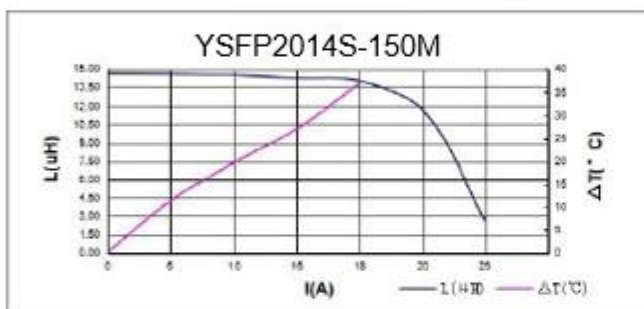
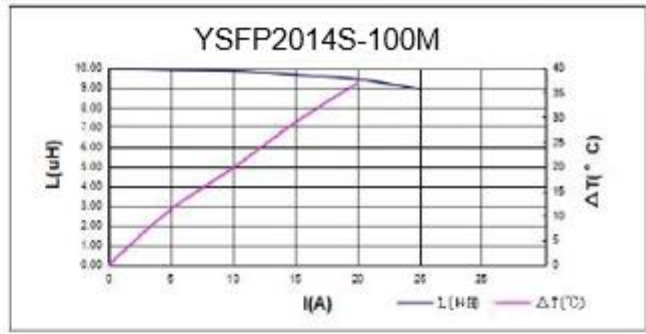
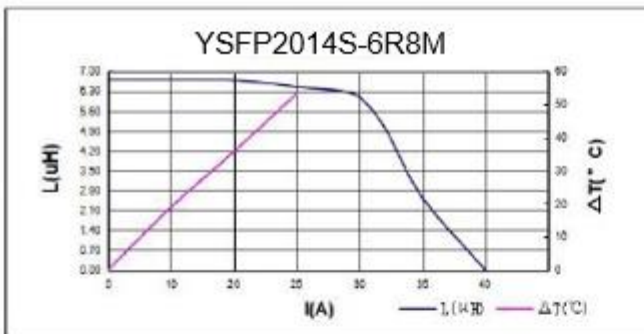
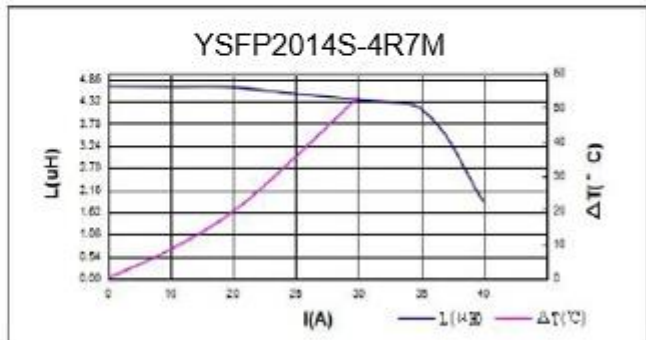
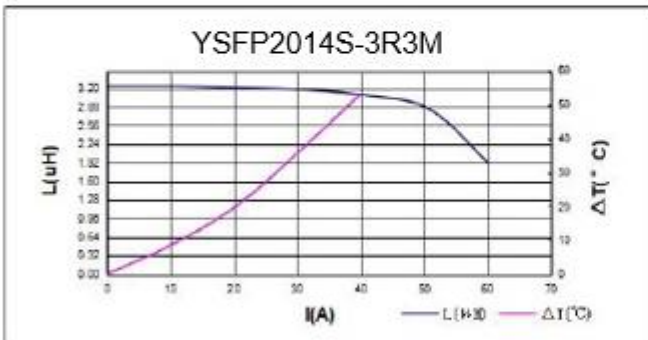
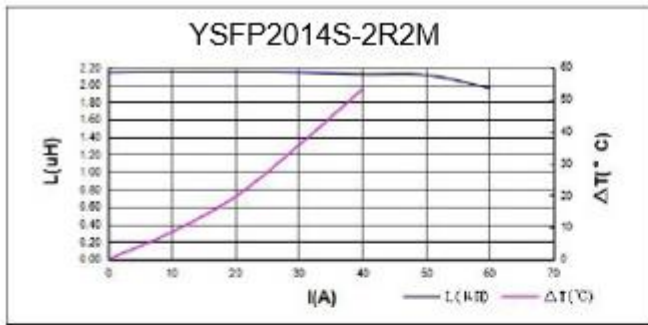

## ■ Reliability

Item	Specification and Requirement	Test Method
Solderability test	Terminals area must have 95% min solder coverage	Solder heat proof: ① Preheating: $160 \pm 10^{\circ}\text{C}$ for 90 seconds ② Retention time: $245 \pm 5^{\circ}\text{C}$ for $2 \pm 0.5$ seconds
Vibration test	Inductance change: Within $\pm 5\%$ Without Mechanical damage such as break	① Vibration frequency: (10Hz to 55Hz to 10Hz) in 60 seconds as a period ② Vibration time: Period cycled for 2 hours in each of 3 mutual perpendicular directions. ③ Amplitude: 1.5mm Max.
Shock test	Inductance change: Within $\pm 5\%$ Without Mechanical damage such as break	① Peak value: 100G. ② Duration of pulse: 11ms. ③ Times in each positive and negative direction of 3 mutual perpendicular directions
Thermal shock	Inductance change: Within $\pm 5\%$ Without Mechanical damage such as break	① Repeat 100 cycle as follow ( $-55 \pm 2^{\circ}\text{C}$ 30 $\pm$ 3 minutes), Room temperature, 5 minutes ( $+125 \pm 2^{\circ}\text{C}$ , 30 $\pm$ 3 minutes) ② Recovery: 48+4/-0 hours of recovery Under the standard condition after the test. (see Note 1)
High temperature life test	Inductance change: Within $\pm 5\%$ Without Mechanical damage such as break	① Environment condition: $85 \pm 2^{\circ}\text{C}$ Applied current: Rated current ② Duration: 1000+4/-0 hours (see Note 1)
Humidity Resistance	Inductance change: Within $\pm 5\%$ Without Mechanical damage such as break	① Environment condition: $60 \pm 2^{\circ}\text{C}$ Humidity: 90-95% Applied current: Rated current ② Duration: 1000+4/-0 hours (see Note 1)
Low temperature life test	Inductance change: Within $\pm 5\%$ Without Mechanical damage such as break	Store temperature $-55 \pm 2^{\circ}\text{C}$ for total 1000+4/-0 hours
High temperature life test	Inductance change: Within $\pm 5\%$ Without Mechanical damage such as break	Store temperature $+125 \pm 2^{\circ}\text{C}$ for total 1000+4/-0 hours

**Reflow Profile**

Power Choke Coil Type

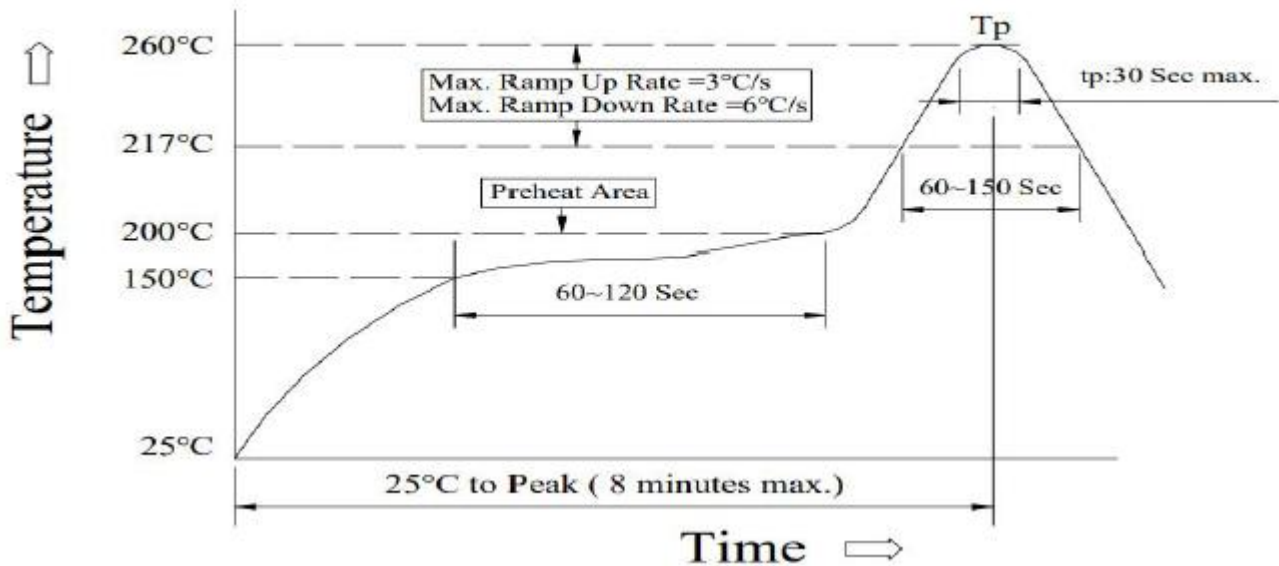

**Reflow Soldering Method**

Reflow Soldering	Tp:255 ~ 260°C Max. 30 seconds(tp)
	217°C 60 ~ 150 seconds
Pre-Heat	150 ~ 200°C 60 ~ 150 seconds
Time 25°C to peak temperature	8 minutes Max.

**Soldering iron method**

350±5°C Max.3 seconds.

**■ Taping Dimensions(Unit:mm)**

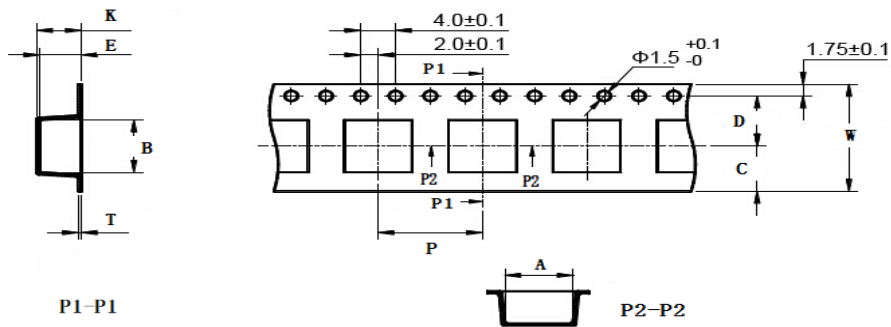

TYPE	W	A	B	C	D	E	P	K Ref	T	MPQ
YSFP2014S	32±0.3	17.5±0.1	18.8±0.1	10.75	11.5±0.1	7.0±0.1	24±0.1	7.5	0.5±0.05	100

**■ Reel Dimensions(Unit:mm)**

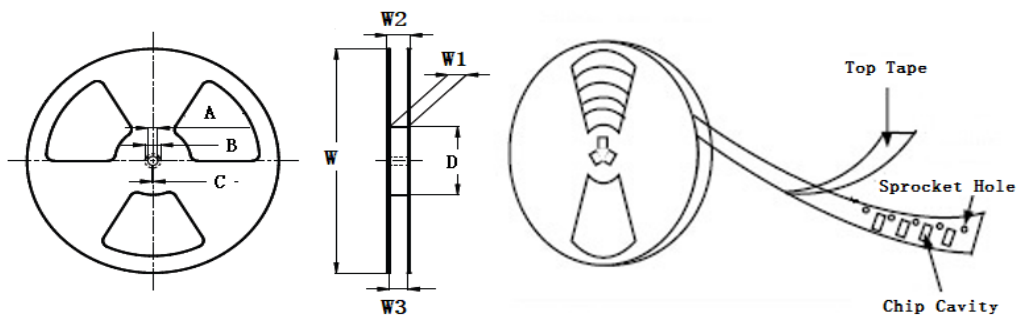

TYPE	W	W1	W2	W3	A	B	C	D
YSFP2014S	330±2.0	32.5±1.5	30.4MAX	23.9 Min	13.0±0.50	21.0±0.80	2.0±0.50	100 Min

**Direction of rolling**

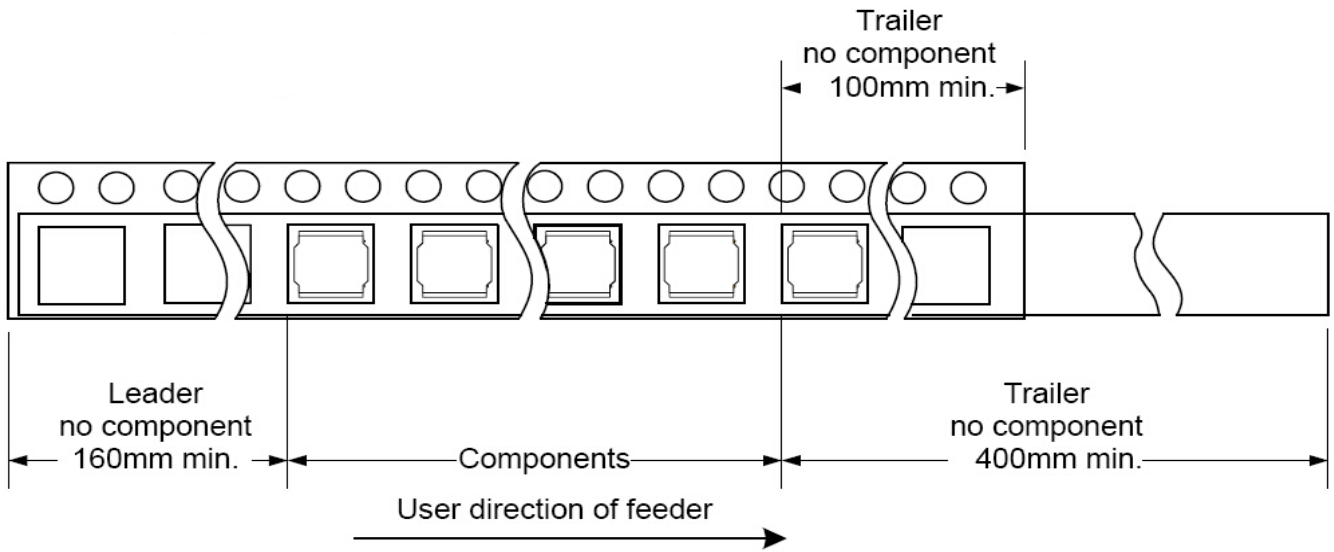

**Cover tape peel off condition**

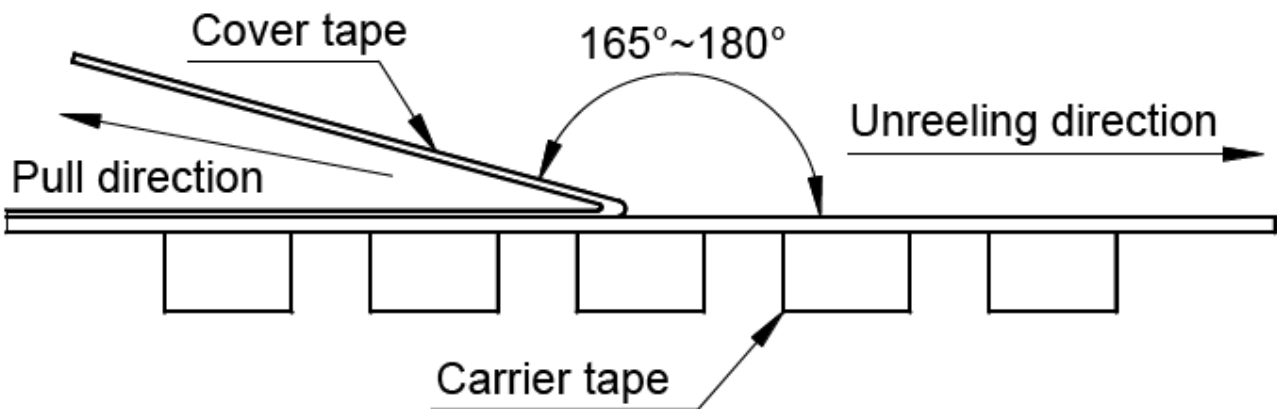

Cover tape peel force shall be 0.1N to 1.3N.

Reference peel speed 300±10mm/min.



## X-ON Electronics

Largest Supplier of Electrical and Electronic Components

*Click to view similar products for [Fixed Inductors](#) category:*

*Click to view products by [YJYCOIN](#) manufacturer:*

Other Similar products are found below :

[CR32NP-100KC](#) [70F224AI](#) [MHQ1005P10NJ](#) [MHQ1005P1N0S](#) [MHQ1005P2N4S](#) [MHQ1005P3N6S](#) [MHQ1005P5N1S](#) [MHQ1005P8N2J](#)  
[PE-53601NL](#) [PE-53602NL](#) [PG0936.113NLT](#) [9220-20](#) [9310-16](#) [PM06-2N7](#) [PM06-39NJ](#) [A01TK](#) [1206CS-471XJ](#) [HC2-R47-R](#) [HC8-1R2-R](#)  
[HCF1305-3R3-R](#) [1206CS-151XG](#) [RCH664NP-4R7M](#) [RCP1317NP-391L](#) [DH2280-4R7M](#) [DS1608C-106](#) [B10TJ](#) [B82498B3101J000](#) [ELJ-](#)  
[RE27NJF2](#) [1812CS-153XJ](#) [1812CS-183XJ](#) [1812CS-223XJ](#) [1812LS-104XJ](#) [1812LS-105XJ](#) [1812LS-124XJ](#) [1812LS-154XJ](#) [1812LS-223XJ](#)  
[1812LS-224XJ](#) [1812LS-563XJ](#) [1812LS-683XJ](#) [1812LS-824XJ](#) [NIN-FB101JTR110F](#) [NIN-FB471JTR62F](#) [NIN-FC1R5JTR220F](#) [NIN-](#)  
[HCR15JTRF](#) [NIN-HCR33JTRF](#) [NIN-HDR22JTRF](#) [NIN-HDR82JTRF](#) [NIN-HK2N7STRF](#) [NIN-PA150KTR370F](#) [NIN-PB100KTR550F](#)