

**■ Features**

- Molding Inductor.
- Low Profile,Low Temp.
- Large Current.
- Customize For Different Need.
- Operating temperature:-55℃ ~ +125℃(Including self - temperature rise).

**■ Applications**

- General Electronic.
- Video Device,TV,TFT.
- Power Module for PC.
- NB/Lap Top Computer.
- Server,VGA Card/Module.

**■ Product Identification**

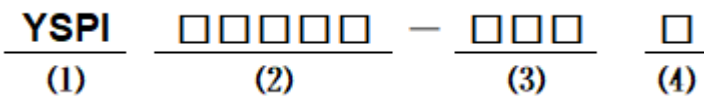

(1) : Type

(2) : Dimensions

(3) : Inductance value

(4) : Inductance Tolerance: N=±30%,M=±20%

**■ Shapes and Dimensions (Unit: mm)**

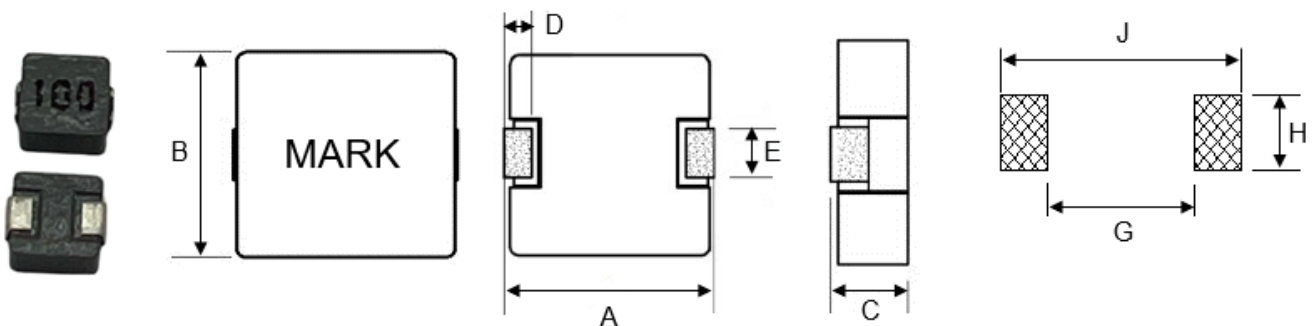

TYPE	A	B	C	D	E	G Ref.	H Ref.	J Ref.
YSPI0320T	3.4±0.3	3.2±0.3	1.8±0.2	0.7±0.2	1.2±0.2	1.9	1.45	4.1

## ■ YSPI0320T Series

Part Number	Inductance ( $\mu$ H) @100KHz 1V	DC Resistance ( $m\Omega$ ) Max.	Saturation Current Isat(A)	Heat Rating Current Irms (A)
YSPI0320T-R33M	0.33 $\pm$ 20%	21	10.0	8.0
YSPI0320T-R47M	0.47 $\pm$ 20%	23	9.0	7.0
YSPI0320T-R68M	0.68 $\pm$ 20%	29	7.0	5.5
YSPI0320T-1R0M	1.0 $\pm$ 20%	38	5.0	4.0
YSPI0320T-1R5M	1.5 $\pm$ 20%	50	4.0	3.8
YSPI0320T-2R2M	2.2 $\pm$ 20%	75	3.7	3.5
YSPI0320T-3R3M	3.3 $\pm$ 20%	145	3.5	3.0
YSPI0320T-4R7M	4.7 $\pm$ 20%	200	3.0	2.6
YSPI0320T-5R6M	5.6 $\pm$ 20%	238	2.6	2.2
YSPI0320T-6R8M	6.8 $\pm$ 20%	300	2.2	1.9
YSPI0320T-8R2M	8.2 $\pm$ 20%	390	1.9	1.6
YSPI0320T-100M	10 $\pm$ 20%	422	1.6	1.4

- ※ All test data is referenced to 25 °C ambient.
- ※ Irms (A):DC current (A) that will cause an approximate  $\Delta T$  of 40 °C(reference ambient temperature is 25 °C).
- ※ Isat(A):DC current (A) that will cause L0 to drop approximately 30%.
- ※ The part temperature (ambient + temp rise) should not exceed 125°C under worst case operating conditions.  
Circuit design, component placement, PWB trace size and thickness, airflow and other cooling provisions all affect the part temperature. Part temperature should be verified in the end application.

## ■ Mechanical Reliability

Item	Specification and Requirement	Test Method
Solderability	1. No case deformation or change in visual 2. New solder coverage More than 95%	1.Preheat: 155°C±5°C , 60S±2S 2.Tin: lead-free. 3.Temperature:240°C±5°C, flux 3.0S±0.5S.
Mechanical shock	1. No case deformation or change in visual 2. $\Delta L/L_0 \leq \pm 10\%$	1. Acceleration: 100G 2. Pulse time: 6ms 3. 3 times in each positive and negative direction of 3 mutual perpendicular directions
Mechanical vibration	1. No case deformation or change in visual 2. $\Delta L/L_0 \leq \pm 10\%$	1. Reflow: 2times 2. Frequency: 10HZ ~ 50HZ ~ 10HZ, 20 Min/Cycles 3. Amplitude: 1.52 mm±10% 4. Directions: X,Y,Z 5. Time: 12 cycle / direction

## ■ Endurance Reliability

Item	Specification and Requirement	Test Method
Thermal Shock	Inductance change: Within ±10% Without distinct damage in appearance	1. First -55°C for 30 minutes, last 125°C for 30 minutes as 1 cycle. Go through 1000 cycles. 2. Max transfer time is 3 minutes. 3. Measured at room temperature after placing for 24±2 hours
Humidity Resistance	Inductance change: Within ±10% Without distinct damage in appearance	1.Reflow 2 times, 2.85°C,85%RH,1000 hours 3.Measured at room temperature after placing for 24±2 hours
Low temperature storage	Inductance change: Within ±10% Without distinct damage in appearance	1. Temperature: -55 ± 2°C 2. Time: 1000 hours 3. Measured at room temperature after placing for 24±2 hours
High temperature storage	Inductance change: Within ±10% Without distinct damage in appearance	1. Temperature: +125 ± 2°C 2. Time: 1000 hours 3. Measured at room temperature after placing for 24±2 hours

**Recommended Soldering Technologies**

**Re-flowing Profile**

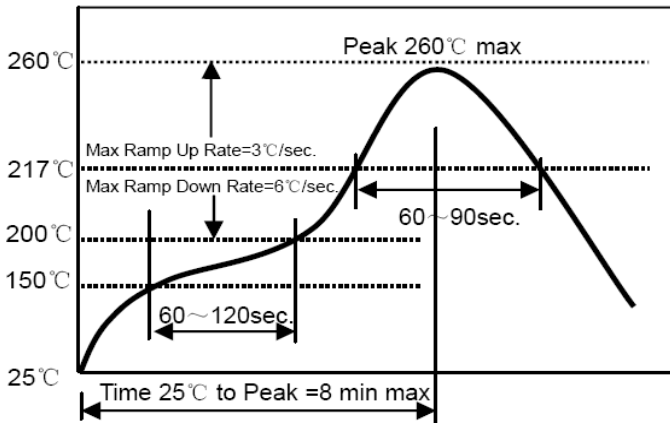

Preheat condition: 150 ~200°C/60~120sec.  
 Allowed time above 217°C: 60~90sec.  
 Peak temp: 260°C  
 Max time at Peak temp: 10 sec.  
 Solder paste: Sn/3.0Ag/0.5Cu  
 Allowed Reflow time: 2x max

**Iron Soldering Profile**

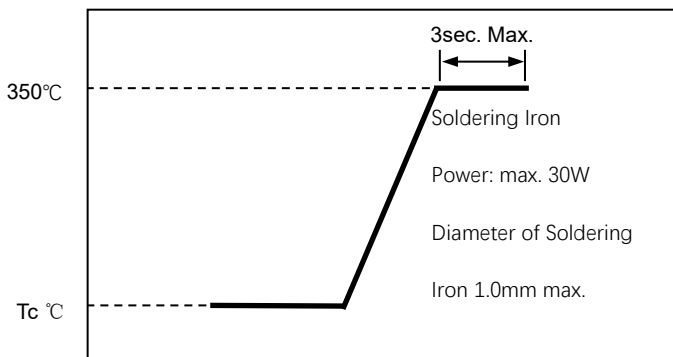

Iron soldering power: Max. 30W  
 Pre-heating: 150°C/60sec.  
 Soldering Tip temperature: 350°C Max.  
 Soldering time: 3sec. Max.  
 Solder paste: Sn/3.0Ag/0.5Cu  
 Max.1 times for iron soldering

**■ Taping Dimensions(Unit:mm)**

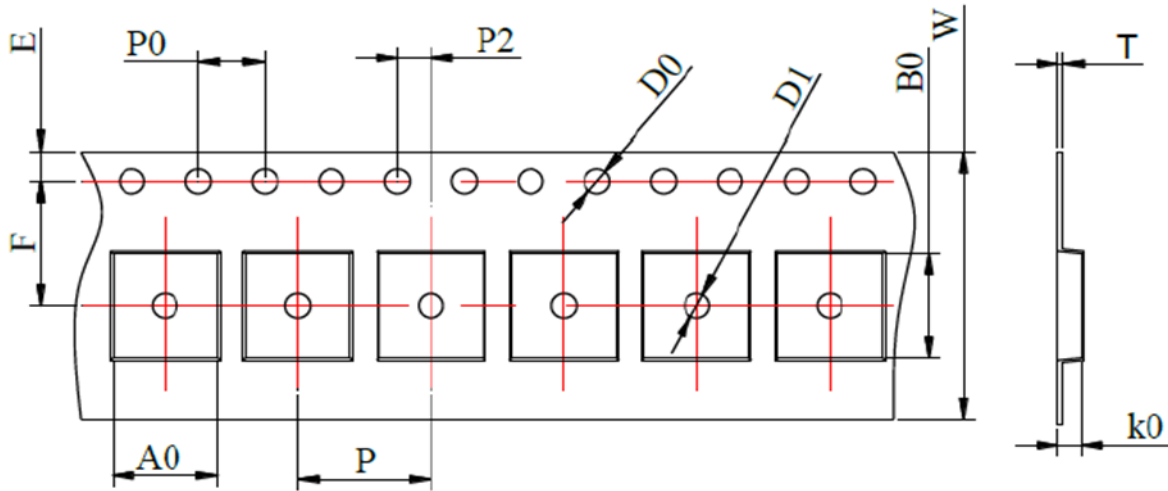

TYPE	W	P	P0	P2	D0	D1	T	A0	B0	K0	E	F	MPQ
YSPI0320T	12 ±0.3	8 ±0.1	4 ±0.1	2 ±0.1	1.5 ±0.1	1.5 ±0.1	0.35 ±0.05	3.4 ±0.1	3.7 ±0.1	2.4 ±0.1	1.75 ±0.1	5.5 ±0.1	3000

**■ Reel Dimensions(Unit:mm)**

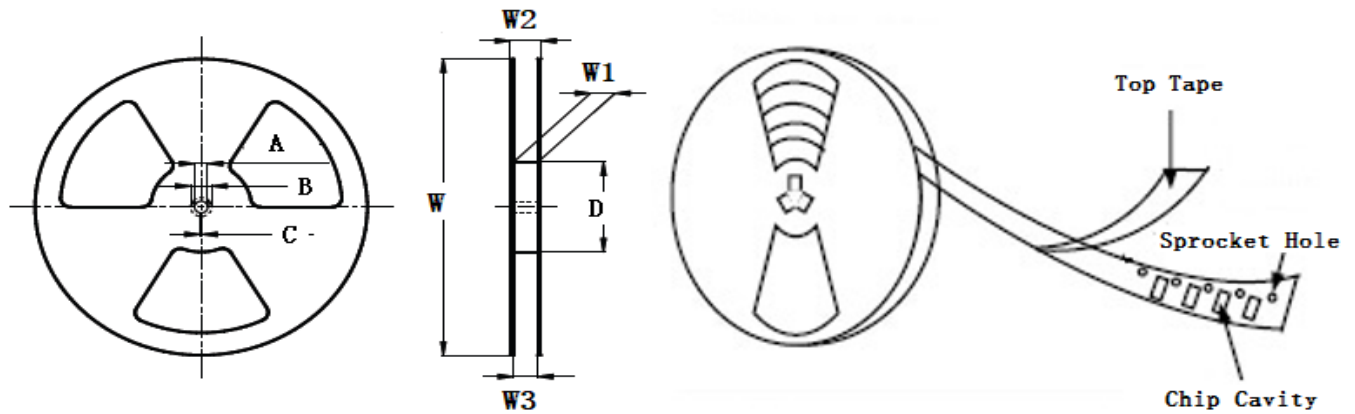

TYPE	W	W1	W2	W3	A	B	C	D
YSPI0320T	330±2.0	12.4±2.00	18.4MAX	11.9 Min	13.0±0.50	21.0±0.80	2.0±0.50	100 Min

**Direction of rolling**



**Cover tape peel off condition**

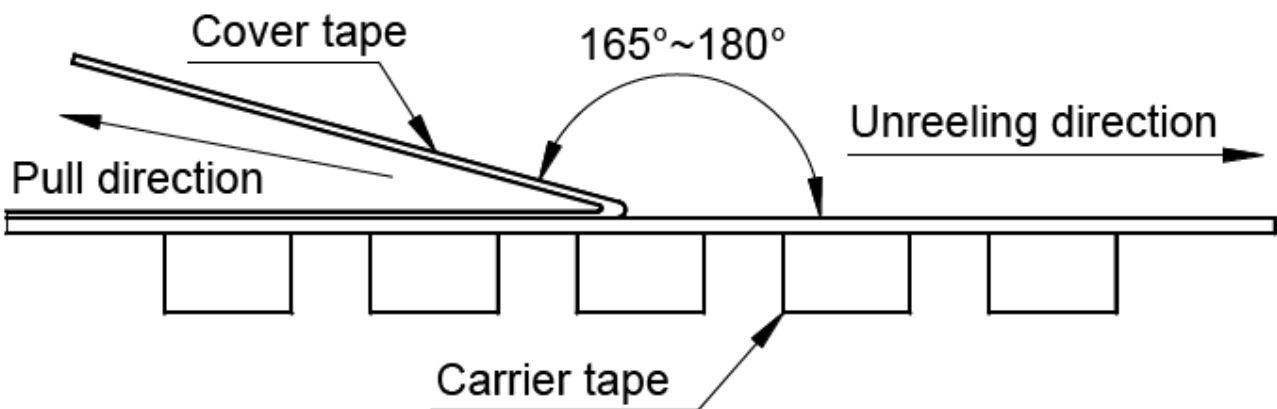

Cover tape peel force shall be 0.1N to 1.3N.

Reference peel speed  $300 \pm 10$  mm/min.

## X-ON Electronics

Largest Supplier of Electrical and Electronic Components

*Click to view similar products for [Fixed Inductors](#) category:*

*Click to view products by [YJYCOIN](#) manufacturer:*

Other Similar products are found below :

[CR32NP-100KC](#) [CR54NP-470LC](#) [70F224AI](#) [MGDQ4-00004-P](#) [MHQ1005P10NJ](#) [MHQ1005P1N0S](#) [MHQ1005P2N4S](#) [MHQ1005P3N6S](#)  
[MHQ1005P5N1S](#) [MHQ1005P8N2J](#) [PE-53601NL](#) [PE-53602NL](#) [PG0936.113NLT](#) [9220-20](#) [9310-16](#) [PM06-2N7](#) [PM06-39NJ](#) [A01TK](#)  
[1206CS-471XJ](#) [HC2-R47-R](#) [HC8-1R2-R](#) [HCF1305-3R3-R](#) [1206CS-151XG](#) [RCH664NP-140L](#) [RCH664NP-4R7M](#) [RCP1317NP-391L](#)  
[RCR110DNP-331L](#) [DH2280-4R7M](#) [DS1608C-106](#) [B10TJ](#) [B82498B3101J000](#) [ELJ-RE27NJF2](#) [1812CS-153XJ](#) [1812CS-183XJ](#) [1812CS-](#)  
[223XJ](#) [1812LS-104XJ](#) [1812LS-105XJ](#) [1812LS-124XJ](#) [1812LS-154XJ](#) [1812LS-223XJ](#) [1812LS-224XJ](#) [1812LS-563XJ](#) [1812LS-683XJ](#)  
[1812LS-824XJ](#) [NIN-FB101JTR110F](#) [NIN-FB471JTR62F](#) [NIN-FC1R5JTR220F](#) [NIN-HCR15JTRF](#) [NIN-HCR33JTRF](#) [NIN-HDR22JTRF](#)