

**■ Features**

- Molding Inductor.
- High reliability.
- High current, low DCR, high efficiency.
- Very low acoustic noise and very low leakage flux noise.
- Operating temperature: -55°C ~ +125°C (Including self-temperature rise) .

**■ Applications**

- General Electronic.
- Video Device, TV, TFT.
- Power Module for PC.
- NB/Lap Top Computer.
- Server, VGA Card/Module.
- DC/DC converter.

**■ Product Identification**



- (1) : Type
- (2) : Dimensions
- (3) : Inductance value
- (4) : Inductance Tolerance : N=±30%,M=±20%

**■ Shapes and Dimensions (Unit: mm)**

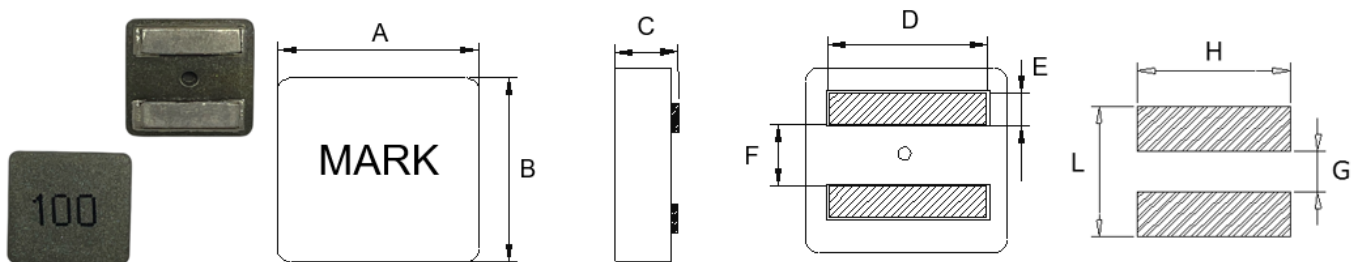

TYPE	A	B	C	D	E	F	G Ref.	H Ref.	L Ref.
YSPIT0650A	6.6±0.2	6.4±0.2	4.8±0.2	5.2±0.4	1.4±0.3	2.6±0.3	2.5	5.6	5.6

## ■ YSPIT0650A Series

Part Number	Inductance (uH) @100KHz/0.1V	DCR Max. (mΩ)	Saturation Current (A)		Heat Rating Current Typ.(A)	
			Max.	Typ.	20°C rise	40°C rise
YSPIT0650A-R82M	0.82±20%	4.2	20.0	24.0	16.0	21.0
YSPIT0650A-1R0M	1.0±20%	4.6	18.0	23.0	15.0	20.0
YSPIT0650A-1R2M	1.2±20%	5.9	16.0	22.0	14.0	18.0
YSPIT0650A-1R5M	1.5±20%	6.3	14.5	19.5	13.0	17.0
YSPIT0650A-1R8M	1.8±20%	7.1	13.5	18.5	12.0	16.0
YSPIT0650A-2R2M	2.2±20%	8.5	12.0	16.0	10.0	13.0
YSPIT0650A-3R3M	3.3±20%	12.5	10.5	12.5	8.5	11.0
YSPIT0650A-4R3M	4.3±20%	16.2	8.5	11.0	7.0	9.0
YSPIT0650A-4R7M	4.7±20%	18.4	8.0	10.5	6.5	8.5

- ※ The saturation current value is the DC current value having inductance decrease down to 30%.(at 25°C)
- ※ The temperature rise current value is the DC current value having temperature increase up to 40°C. (at 25°C)
- ※ The rated current is the DC current value that satisfies both of current value saturation current value and temperature rise current value.

## ■ Mechanical Reliability

Item	Specification and Requirement	Test Method
Solderability	1. No case deformation or change in visual 2. New solder coverage More than 95%	1. Preheat : $155^{\circ}\text{C} \pm 5^{\circ}\text{C}$ , $60\text{S} \pm 2\text{S}$ 2. Tin: lead-free. 3. Temperature: $240^{\circ}\text{C} \pm 5^{\circ}\text{C}$ , flux $3.0\text{S} \pm 0.5\text{S}$ .
Mechanical shock	1. No case deformation or change in visual 2. $\Delta\text{L}/\text{Lo} \leq \pm 10\%$	1. Acceleration : 100G 2. Pulse time: : 6ms 3. 3 times in each positive and negative direction of 3 mutual perpendicular directions
Mechanical vibration	1. No case deformation or change in visual 2. $\Delta\text{L}/\text{Lo} \leq \pm 10\%$	1. Reflow: 2times 2. Frequency: 10HZ ~ 50HZ ~ 10HZ, 20 Min/Cycles 3. Amplitude: $1.52\text{ mm} \pm 10\%$ 4. Directions: X,Y,Z 5. Time: 12 cycle / direction

## ■ Endurance Reliability

Item	Specification and Requirement	Test Method
Thermal Shock	Inductance change: Within $\pm 10\%$ Without distinct damage in visual	1. First $-55^{\circ}\text{C}$ for 30 minutes, last $125^{\circ}\text{C}$ for 30 minutes as 1 cycle. Go through 1000 cycles. 2. Max transfer time is 3 minutes. 3. Measured at room temperature after placing for $24 \pm 2$ hours
Biased Humidity	Inductance change: Within $\pm 10\%$ Without distinct damage in visual	1. Reflow 2 times, $2.85^{\circ}\text{C} \pm 3^{\circ}\text{C}$ , $85\% \pm 3\% \text{RH}$ , 1000 hours 3. Measured at room temperature after placing for $24 \pm 2$ hours
Low temperature storage	Inductance change: Within $\pm 10\%$ Without distinct damage in visual	1. Temperature : $-55 \pm 2^{\circ}\text{C}$ 2. Time : 1000 hours 3. Measured at room temperature after placing for $24 \pm 2$ hours
High temperature storage	Inductance change: Within $\pm 10\%$ Without distinct damage in visual	1. Temperature : $+125 \pm 2^{\circ}\text{C}$ 2. Time : 1000 hours 3. Measured at room temperature after placing for $24 \pm 2$ hours

**Recommended Soldering Technologies**

**Re-flowing Profile**

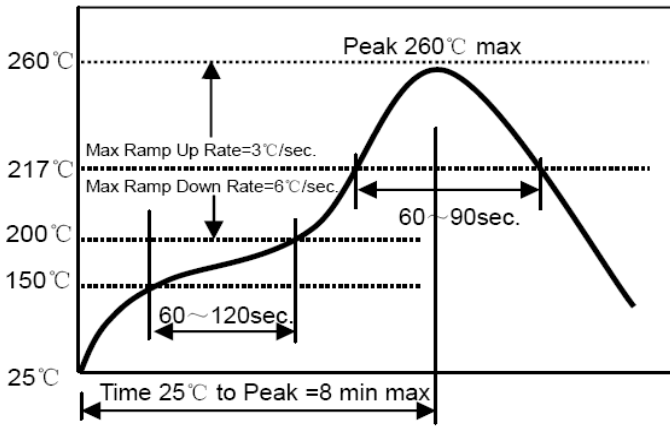

Preheat condition: 150 ~200°C/60~120sec.  
 Allowed time above 217°C: 60~90sec.  
 Peak temp: 260°C  
 Max time at Peak temp: 10 sec.  
 Solder paste: Sn/3.0Ag/0.5Cu  
 Allowed Reflow time: 2x max

**Iron Soldering Profile**

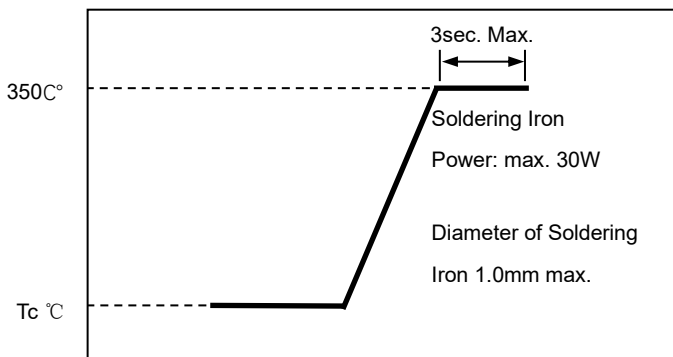

Iron soldering power: Max. 30W  
 Pre-heating: 150°C/60sec.  
 Soldering Tip temperature: 350°C Max.  
 Soldering time: 3sec. Max.  
 Solder paste: Sn/3.0Ag/0.5Cu  
 Max.1 times for iron soldering

**■ Taping Dimensions(Unit:mm)**

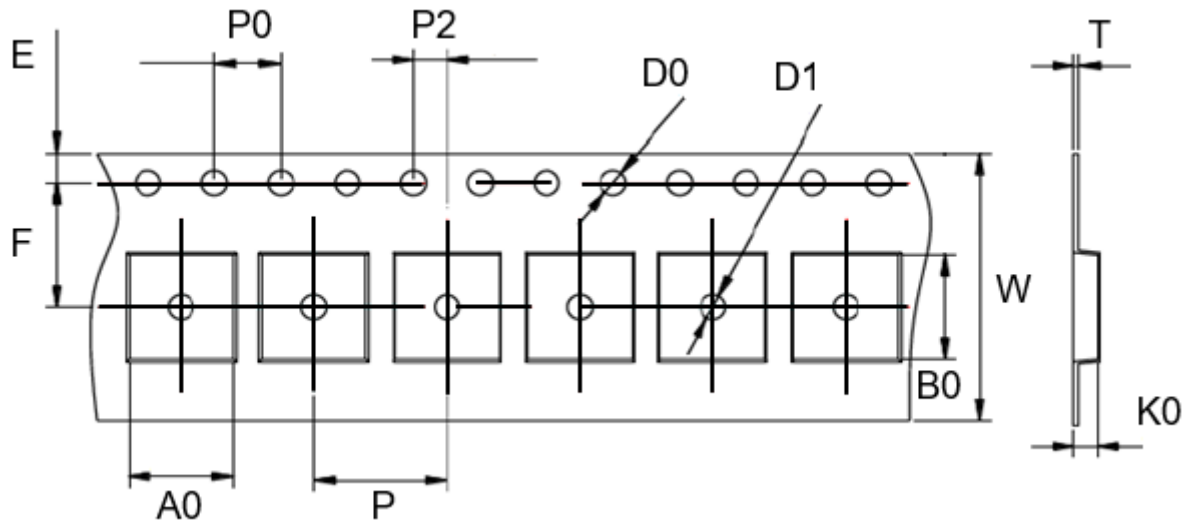

TYPE	W	P	P0	P2	D0	D1	T	A0	B0	K0	E	F	MPQ
YSPIT0650A	16 ±0.3	12 ±0.1	4 ±0.1	2 ±0.1	1.5 ±0.1	1.5 ±0.1	0.35 ±0.05	7.0 ±0.1	6.8 ±0.1	5.3 ±0.1	1.75 ±0.1	7.5 ±0.1	800

**■ Reel Dimensions(Unit:mm)**

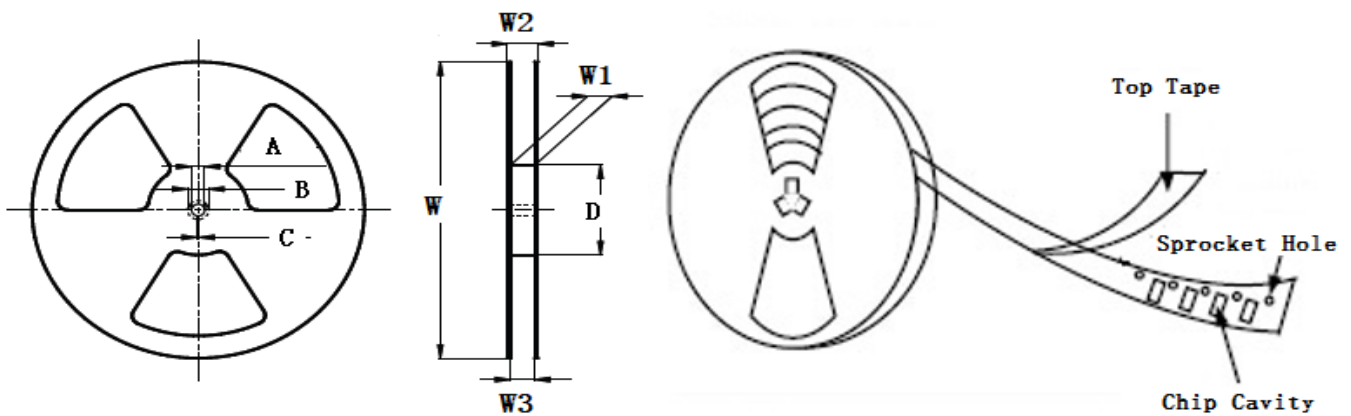

TYPE	W	W1	W2	W3	A	B	C	D
YSPIT0650A	330±2.0	16.4±2.0	22.4MAX	15.9 Min	13.0±0.5	21.0±0.8	2.0±0.5	97±0.5

**Direction of rolling**

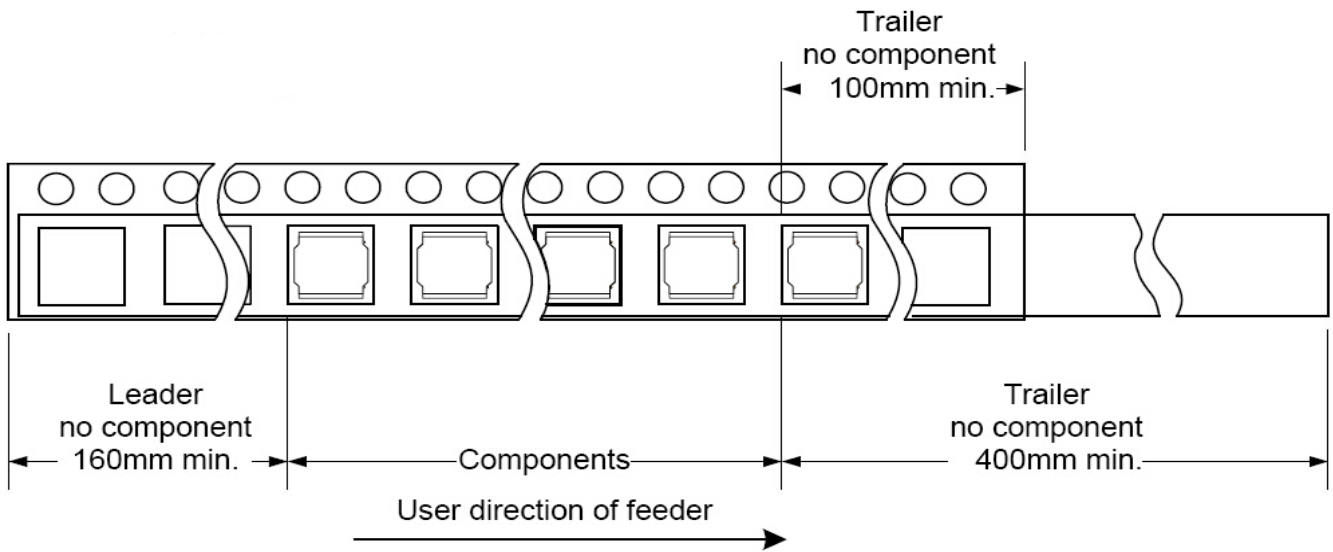

**Cover tape peel off condition**

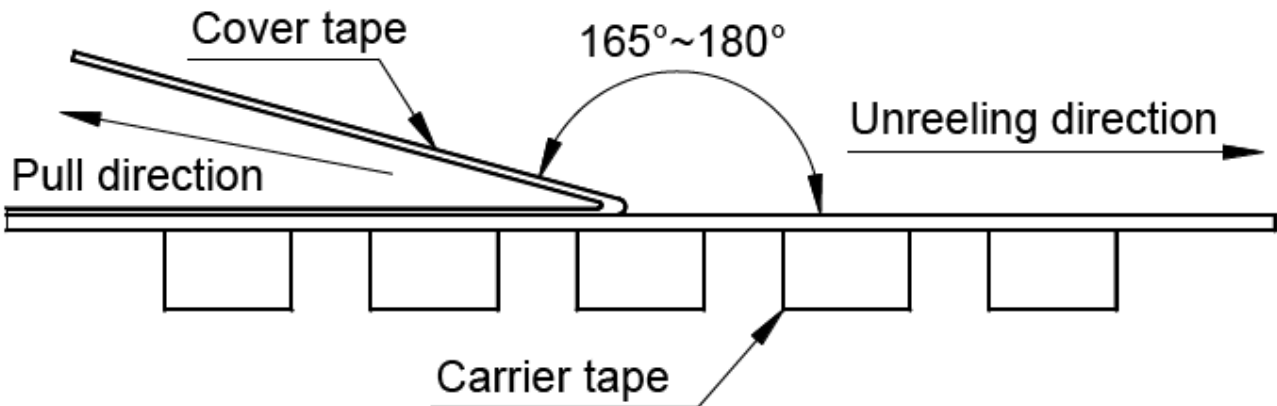

Cover tape peel force shall be 0.1N to 1.3N.

Reference peel speed 300±10mm/min.

## X-ON Electronics

Largest Supplier of Electrical and Electronic Components

*Click to view similar products for [Fixed Inductors](#) category:*

*Click to view products by [YJYCOIN](#) manufacturer:*

Other Similar products are found below :

[CR32NP-100KC](#) [CR54NP-470LC](#) [70F224AI](#) [MGDQ4-00004-P](#) [MHQ1005P10NJ](#) [MHQ1005P1N0S](#) [MHQ1005P2N4S](#) [MHQ1005P3N6S](#)  
[MHQ1005P5N1S](#) [MHQ1005P8N2J](#) [PE-53601NL](#) [PE-53602NL](#) [PG0936.113NLT](#) [9220-20](#) [9310-16](#) [PM06-2N7](#) [PM06-39NJ](#) [A01TK](#)  
[1206CS-471XJ](#) [HC2-R47-R](#) [HC8-1R2-R](#) [HCF1305-3R3-R](#) [1206CS-151XG](#) [RCH664NP-140L](#) [RCH664NP-4R7M](#) [RCP1317NP-391L](#)  
[RCR110DNP-331L](#) [DH2280-4R7M](#) [DS1608C-106](#) [B10TJ](#) [B82498B3101J000](#) [ELJ-RE27NJF2](#) [1812CS-153XJ](#) [1812CS-183XJ](#) [1812CS-](#)  
[223XJ](#) [1812LS-104XJ](#) [1812LS-105XJ](#) [1812LS-124XJ](#) [1812LS-154XJ](#) [1812LS-223XJ](#) [1812LS-224XJ](#) [1812LS-563XJ](#) [1812LS-683XJ](#)  
[1812LS-824XJ](#) [NIN-FB101JTR110F](#) [NIN-FB471JTR62F](#) [NIN-FC1R5JTR220F](#) [NIN-HCR15JTRF](#) [NIN-HCR33JTRF](#) [NIN-HDR22JTRF](#)