

**■ Features**

- Molding Inductor.
- High reliability.
- High current, low DCR, high efficiency.
- Very low acoustic noise and very low leakage flux noise.
- Operating temperature:  $-55^{\circ}\text{C} \sim +125^{\circ}\text{C}$  (Including self-temperature rise) .

**■ Applications**

- General Electronic.
- Video Device, TV, TFT.
- Power Module for PC.
- NB/Lap Top Computer.
- Server, VGA Card/Module.
- DC/DC converter.

**■ Product Identification**



- (1) : Type
- (2) : Dimensions
- (3) : Inductance value
- (4) : Inductance Tolerance : N= $\pm 30\%$ , M= $\pm 20\%$

**■ Shapes and Dimensions (Unit: mm)**

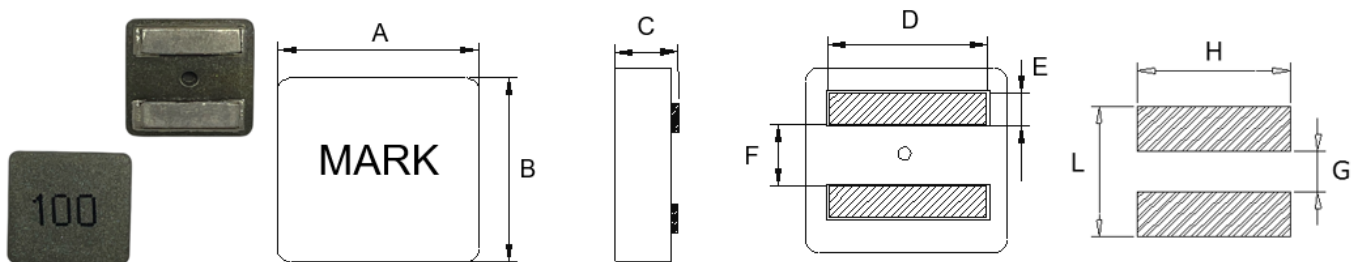

TYPE	A	B	C	D	E	F	G Ref.	H Ref.	L Ref.
YSPIT0660A	6.6 $\pm$ 0.2	6.4 $\pm$ 0.2	5.8 $\pm$ 0.2	5.3 $\pm$ 0.3	1.4 $\pm$ 0.3	2.6 $\pm$ 0.3	2.5	5.6	5.6

## ■ YSPIT0660A Series

Part Number	Inductance (uH) @100KHz/0.1V	DCR Max. (mΩ)	Saturation Current (A)		Heat Rating Current Typ.(A)	
			Max.	Typ.	20°C rise	40°C rise
YSPIT0660A-1R0M	1.0±20%	4.4	19.0	24.0	16.0	21.0
YSPIT0660A-1R5M	1.5±20%	6.1	15.0	20.0	13.5	17.5
YSPIT0660A-2R2M	2.2±20%	8.1	12.5	16.5	11.0	14.0
YSPIT0660A-3R3M	3.3±20%	12.3	11.0	13.0	9.0	12.0
YSPIT0660A-4R7M	4.7±20%	14.4	9.3	10.5	8.5	11.0
YSPIT0660A-5R6M	5.6±20%	15.9	8.7	9.9	7.6	10.0
YSPIT0660A-6R8M	6.8±20%	20.8	8.1	9.2	7.0	9.0
YSPIT0660A-8R2M	8.2±20%	26.4	8.0	8.4	6.0	8.0
YSPIT0660A-100M	10±20%	29.9	6.8	7.6	5.0	7.0
YSPIT0660A-150M	15±20%	43.8	5.0	5.8	4.5	6.0
YSPIT0660A-220M	22±20%	60.7	4.8	5.6	3.8	5.0

- ※ The saturation current value is the DC current value having inductance decrease down to 30%.(at 25°C)
- ※ The temperature rise current value is the DC current value having temperature increase up to 40°C. (at 25°C)
- ※ The rated current is the DC current value that satisfies both of current value saturation current value and temperature rise current value.

## ■ Mechanical Reliability

Item	Specification and Requirement	Test Method
Solderability	1. No case deformation or change in visual 2. New solder coverage More than 95%	1.Preheat : 155°C±5°C , 60S±2S 2.Tin: lead-free. 3.Temperature:240°C±5°C , flux 3.0S±0.5S.
Mechanical shock	1. No case deformation or change in visual 2. $\Delta L/L_0 \leq \pm 10\%$	1. Acceleration : 100G 2. Pulse time: : 6ms 3. 3 times in each positive and negative direction of 3 mutual perpendicular directions
Mechanical vibration	1. No case deformation or change in visual 2. $\Delta L/L_0 \leq \pm 10\%$	1. Reflow: 2times 2. Frequency: 10HZ ~ 50HZ ~ 10HZ, 20 Min/Cycles 3. Amplitude: 1.52 mm±10% 4. Directions: X,Y,Z 5. Time: 12 cycle / direction

## ■ Endurance Reliability

Item	Specification and Requirement	Test Method
Thermal Shock	Inductance change: Within $\pm 10\%$ Without distinct damage in visual	1. First -55°C° for 30 minutes, last 125°C° for 30 minutes as 1 cycle. Go through 1000 cycles. 2. Max transfer time is 3 minutes. 3. Measured at room temperature after placing for 24±2 hours
Biased Humidity	Inductance change: Within $\pm 10\%$ Without distinct damage in visual	1.Reflow 2 times, 2.85°C°±3C°,85%±3%RH,1000 hours 3.Measured at room temperature after placing for 24±2 hours
Low temperature storage	Inductance change: Within $\pm 10\%$ Without distinct damage in visual	1. Temperature : -55 $\pm$ 2C° 2. Time : 1000 hours 3. Measured at room temperature after placing for 24±2 hours
High temperature storage	Inductance change: Within $\pm 10\%$ Without distinct damage in visual	1. Temperature : +125 $\pm$ 2C° 2. Time : 1000 hours 3. Measured at room temperature after placing for 24±2 hours

**Recommended Soldering Technologies**

**Re-flowing Profile**

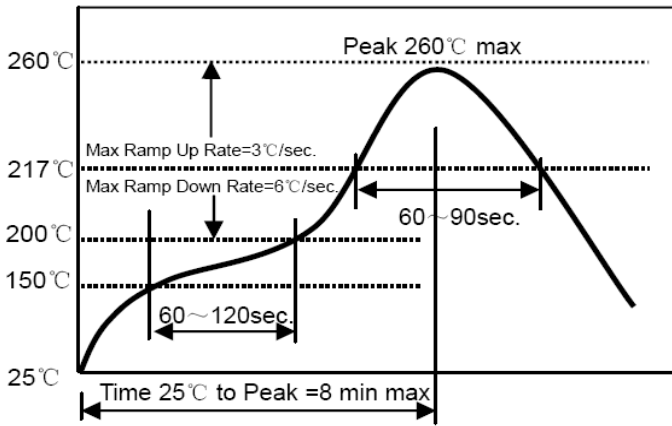

Preheat condition: 150 ~200°C/60~120sec.  
 Allowed time above 217°C: 60~90sec.  
 Peak temp: 260°C  
 Max time at Peak temp: 10 sec.  
 Solder paste: Sn/3.0Ag/0.5Cu  
 Allowed Reflow time: 2x max

**Iron Soldering Profile**

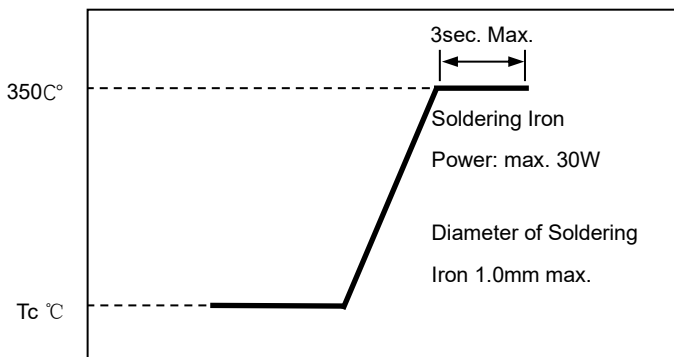

Iron soldering power: Max. 30W  
 Pre-heating: 150°C/60sec.  
 Soldering Tip temperature: 350°C Max.  
 Soldering time: 3sec. Max.  
 Solder paste: Sn/3.0Ag/0.5Cu  
 Max.1 times for iron soldering

**■ Taping Dimensions(Unit:mm)**

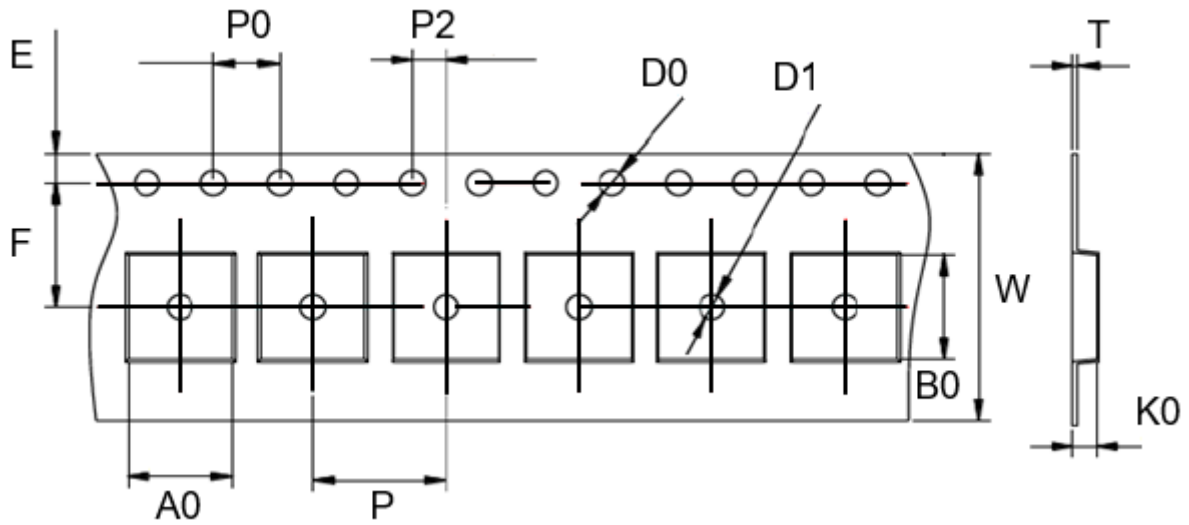

TYPE	W	P	P0	P2	D0	D1	T	A0	B0	K0	E	F	MPQ
YSPIT0660A	16 ±0.3	12 ±0.1	4 ±0.1	2 ±0.1	1.5 ±0.1	1.5 ±0.1	0.35 ±0.05	7.0 ±0.1	6.8 ±0.1	6.3 ±0.1	1.75 ±0.1	7.5 ±0.1	750

**■ Reel Dimensions(Unit:mm)**

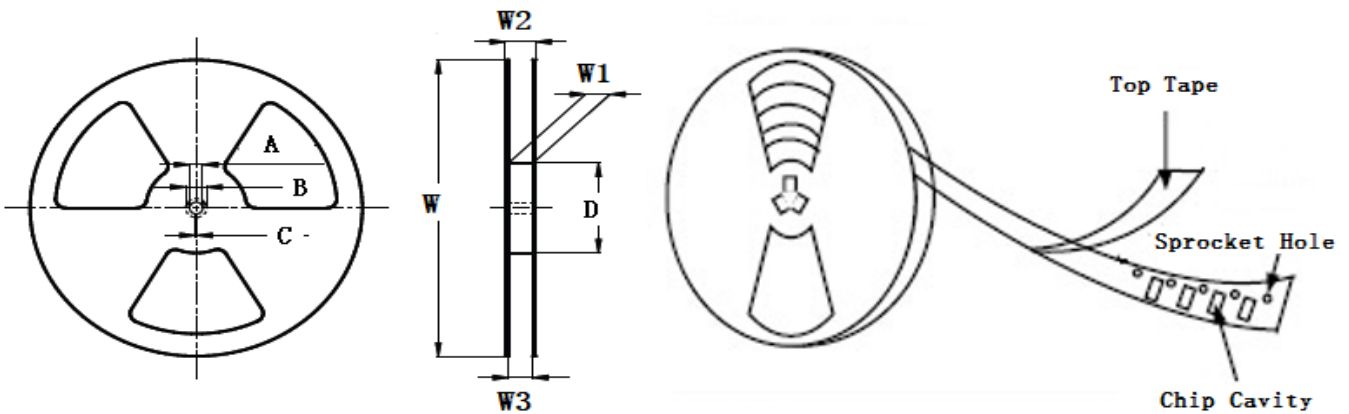

TYPE	W	W1	W2	W3	A	B	C	D
YSPIT0660A	330±2.0	16.4±2.0	22.4MAX	15.9 Min	13.0±0.5	21.0±0.8	2.0±0.5	97±0.5

**Direction of rolling**

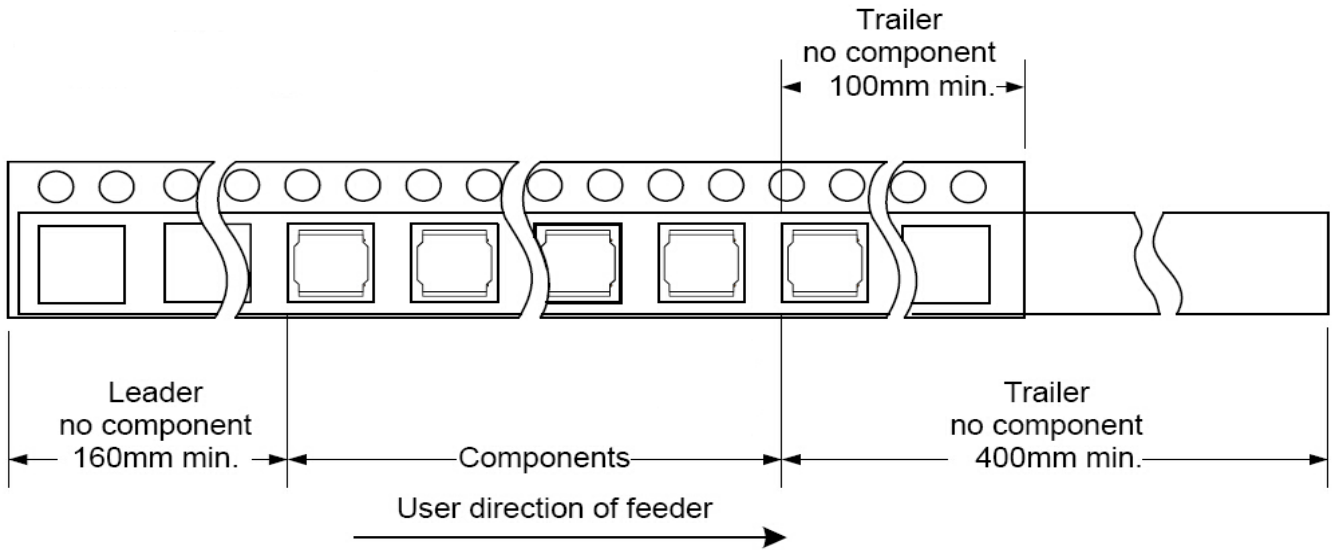

**Cover tape peel off condition**

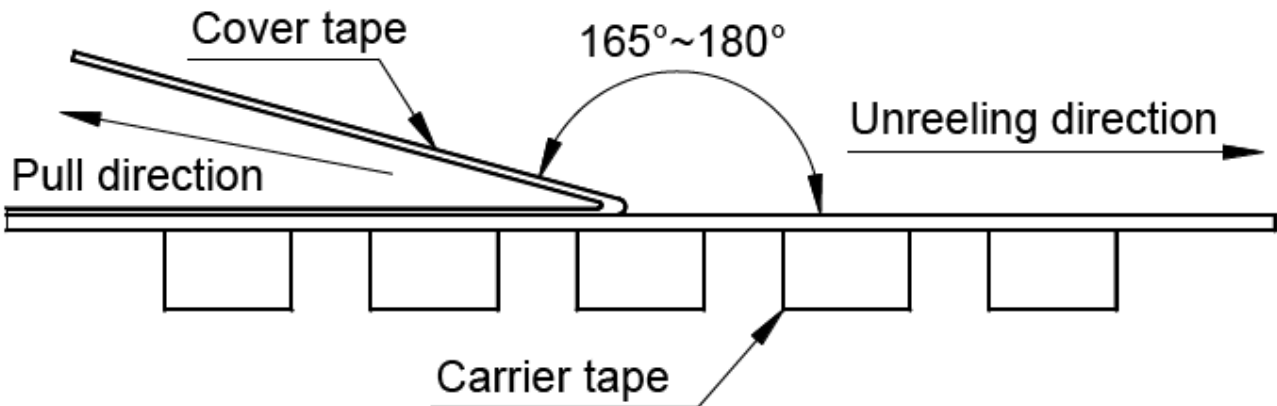

Cover tape peel force shall be 0.1N to 1.3N.

Reference peel speed 300±10mm/min.

## X-ON Electronics

Largest Supplier of Electrical and Electronic Components

*Click to view similar products for [Fixed Inductors](#) category:*

*Click to view products by [YJYCOIN](#) manufacturer:*

Other Similar products are found below :

[CR32NP-100KC](#) [CR54NP-470LC](#) [70F224AI](#) [MGDQ4-00004-P](#) [MHQ1005P10NJ](#) [MHQ1005P1N0S](#) [MHQ1005P2N4S](#) [MHQ1005P3N6S](#)  
[MHQ1005P5N1S](#) [MHQ1005P8N2J](#) [PE-53601NL](#) [PE-53602NL](#) [PG0936.113NLT](#) [9220-20](#) [9310-16](#) [PM06-2N7](#) [PM06-39NJ](#) [A01TK](#)  
[1206CS-471XJ](#) [HC2-R47-R](#) [HC8-1R2-R](#) [HCF1305-3R3-R](#) [1206CS-151XG](#) [RCH664NP-140L](#) [RCH664NP-4R7M](#) [RCP1317NP-391L](#)  
[RCR110DNP-331L](#) [DH2280-4R7M](#) [DS1608C-106](#) [B10TJ](#) [B82498B3101J000](#) [ELJ-RE27NJF2](#) [1812CS-153XJ](#) [1812CS-183XJ](#) [1812CS-](#)  
[223XJ](#) [1812LS-104XJ](#) [1812LS-105XJ](#) [1812LS-124XJ](#) [1812LS-154XJ](#) [1812LS-223XJ](#) [1812LS-224XJ](#) [1812LS-563XJ](#) [1812LS-683XJ](#)  
[1812LS-824XJ](#) [NIN-FB101JTR110F](#) [NIN-FB471JTR62F](#) [NIN-FC1R5JTR220F](#) [NIN-HCR15JTRF](#) [NIN-HCR33JTRF](#) [NIN-HDR22JTRF](#)