

■ Features

- Molding Inductor.
- High reliability.
- High current, low DCR, high efficiency.
- Very low acoustic noise and very low leakage flux noise.
- Operating temperature: $-55^{\circ}\text{C} \sim +125^{\circ}\text{C}$ (Including self-temperature rise) .

■ Applications

- General Electronic.
- Video Device, TV, TFT.
- Power Module for PC.
- NB/Lap Top Computer.
- Server, VGA Card/Module.
- DC/DC converter.

■ Product Identification

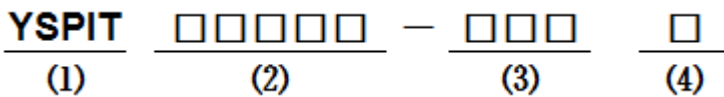

(1) : Type

(2) : Dimensions

(3) : Inductance value

(4) : Inductance Tolerance : N= $\pm 30\%$, M= $\pm 20\%$

■ Shapes and Dimensions (Unit: mm)

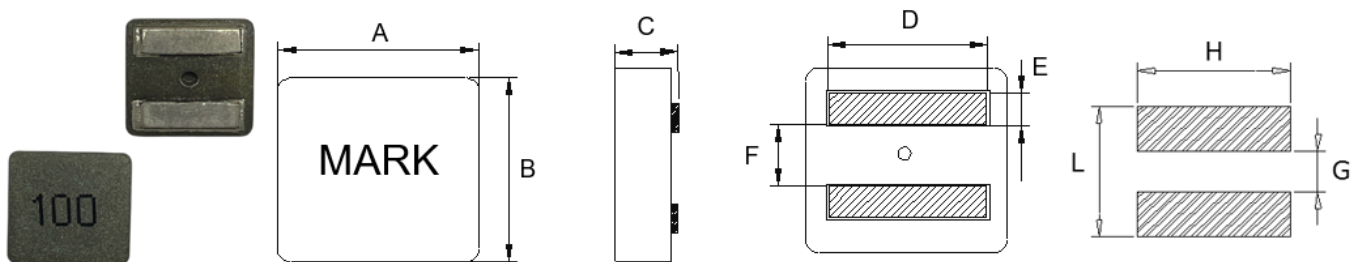

| TYPE | A | B | C | D | E | F | G Ref. | H Ref. | L Ref. |
|------------|----------------|----------------|---------------|----------------|---------------|---------------|--------|--------|--------|
| YSPIT1508A | 16.5 \pm 0.3 | 15.5 \pm 0.3 | 7.7 \pm 0.3 | 13.2 \pm 0.5 | 3.2 \pm 0.3 | 7.0 \pm 0.5 | 6.0 | 15.0 | 15.0 |

■ YSPIT1508A Series

| Part Number | Inductance (uH) @100KHz/0.1V | DCR Max. (mΩ) | Saturation Current (A) | | Heat Rating Current Typ.(A) | |
|-----------------|------------------------------------|------------------|------------------------|------|--------------------------------|-----------|
| | | | Max. | Typ. | 20°C rise | 40°C rise |
| YSPIT1508A-2R0M | 2.0±20% | 2.3 | 52.0 | 57.0 | 29.5 | 40.0 |
| YSPIT1508A-2R2M | 2.2±20% | 2.5 | 49.0 | 55.0 | 28.0 | 37.0 |
| YSPIT1508A-3R0M | 3.0±20% | 3.0 | 41.0 | 46.0 | 26.0 | 34.5 |
| YSPIT1508A-4R2M | 4.2±20% | 4.7 | 33.0 | 38.0 | 20.5 | 27.0 |
| YSPIT1508A-5R3M | 5.3±20% | 5.4 | 31.0 | 35.0 | 19.5 | 26.0 |
| YSPIT1508A-6R2M | 6.2±20% | 6.5 | 31.0 | 34.0 | 17.0 | 23.0 |
| YSPIT1508A-7R2M | 7.2±20% | 7.2 | 29.0 | 32.0 | 15.0 | 21.0 |
| YSPIT1508A-8R2M | 8.2±20% | 8.0 | 25.0 | 28.0 | 13.0 | 19.0 |
| YSPIT1508A-100M | 10±20% | 9.6 | 21.0 | 24.0 | 11.0 | 16.0 |
| YSPIT1508A-150M | 15±20% | 15.0 | 18.0 | 21.0 | 10.0 | 13.0 |
| YSPIT1508A-220M | 22±20% | 23.2 | 16.0 | 19.0 | 9.0 | 12.0 |

- ※ The saturation current value is the DC current value having inductance decrease down to 30%.(at 25°C)
- ※ The temperature rise current value is the DC current value having temperature increase up to 40°C. (at 25°C)
- ※ The rated current is the DC current value that satisfies both of current value saturation current value and temperature rise current value.

■ Mechanical Reliability

| Item | Specification and Requirement | Test Method |
|----------------------|--|--|
| Solderability | 1. No case deformation or change in visual 2. New solder coverage More than 95% | 1.Preheat : 155°C±5°C , 60S±2S 2.Tin: lead-free. 3.Temperature:240°C±5°C , flux 3.0S±0.5S. |
| Mechanical shock | 1. No case deformation or change in visual 2. $\Delta L/L_0 \leq \pm 10\%$ | 1. Acceleration : 100G 2. Pulse time: : 6ms 3. 3 times in each positive and negative direction of 3 mutual perpendicular directions |
| Mechanical vibration | 1. No case deformation or change in visual 2. $\Delta L/L_0 \leq \pm 10\%$ | 1. Reflow: 2times 2. Frequency: 10HZ ~ 50HZ ~ 10HZ, 20 Min/Cycles 3. Amplitude: 1.52 mm±10% 4. Directions: X,Y,Z 5. Time: 12 cycle / direction |

■ Endurance Reliability

| Item | Specification and Requirement | Test Method |
|--------------------------|---|--|
| Thermal Shock | Inductance change: Within $\pm 10\%$ Without distinct damage in visual | 1. First -55°C° for 30 minutes, last 125°C° for 30 minutes as 1 cycle. Go through 1000 cycles. 2. Max transfer time is 3 minutes. 3. Measured at room temperature after placing for 24±2 hours |
| Biased Humidity | Inductance change: Within $\pm 10\%$ Without distinct damage in visual | 1.Reflow 2 times, 2.85°C°±3C°,85%±3%RH,1000 hours 3.Measured at room temperature after placing for 24±2 hours |
| Low temperature storage | Inductance change: Within $\pm 10\%$ Without distinct damage in visual | 1. Temperature : -55 \pm 2C° 2. Time : 1000 hours 3. Measured at room temperature after placing for 24±2 hours |
| High temperature storage | Inductance change: Within $\pm 10\%$ Without distinct damage in visual | 1. Temperature : +125 \pm 2C° 2. Time : 1000 hours 3. Measured at room temperature after placing for 24±2 hours |

Recommended Soldering Technologies

Re-flowing Profile

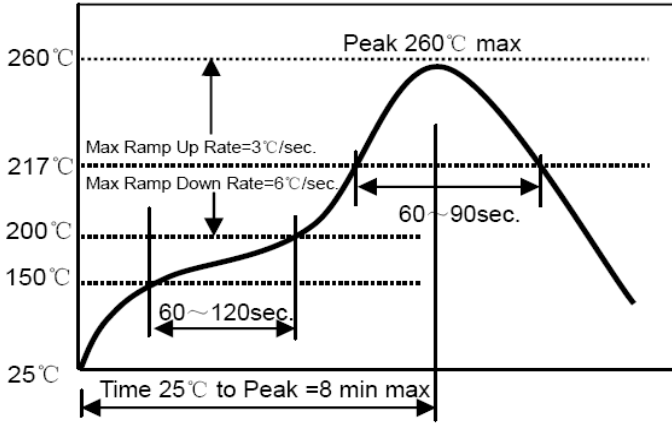

Preheat condition: 150 ~200°C/60~120sec.
 Allowed time above 217°C: 60~90sec.
 Peak temp: 260°C
 Max time at Peak temp: 10 sec.
 Solder paste: Sn/3.0Ag/0.5Cu
 Allowed Reflow time: 2x max

Iron Soldering Profile

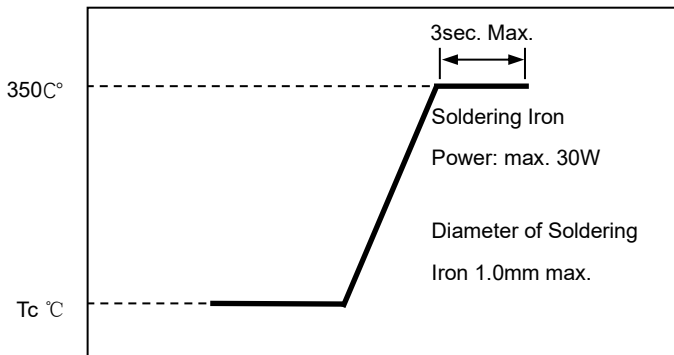

Iron soldering power: Max. 30W
 Pre-heating: 150°C/60sec.
 Soldering Tip temperature: 350°C Max.
 Soldering time: 3sec. Max.
 Solder paste: Sn/3.0Ag/0.5Cu
 Max.1 times for iron soldering

■ Taping Dimensions(Unit:mm)

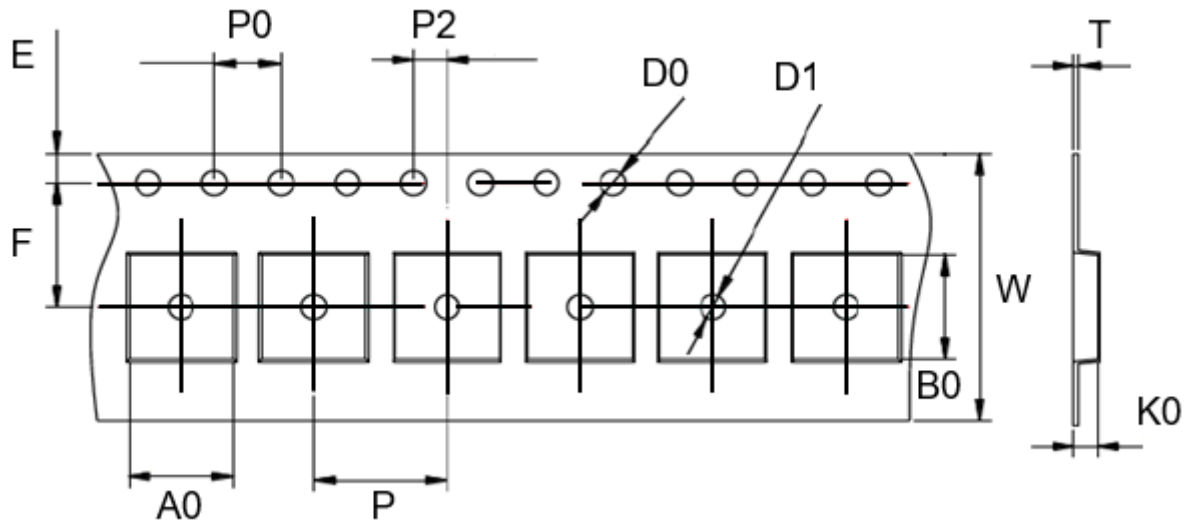

| TYPE | W | P | P0 | P2 | D0 | D1 | T | A0 | B0 | K0 | E | F | MPQ |
|------------|--------------|--------------|-------------|-------------|-------------|-------------|--------------|--------------|--------------|-------------|--------------|--------------|-----|
| YSPIT1508A | 32.0 ±0.3 | 24.0 ±0.1 | 4.0 ±0.1 | 2.0 ±0.1 | 1.5 ±0.1 | 1.5 ±0.1 | 0.5 ±0.05 | 17.0 ±0.1 | 16.0 ±0.1 | 8.5 ±0.1 | 1.75 ±0.1 | 14.2 ±0.1 | 200 |

■ Reel Dimensions(Unit:mm)

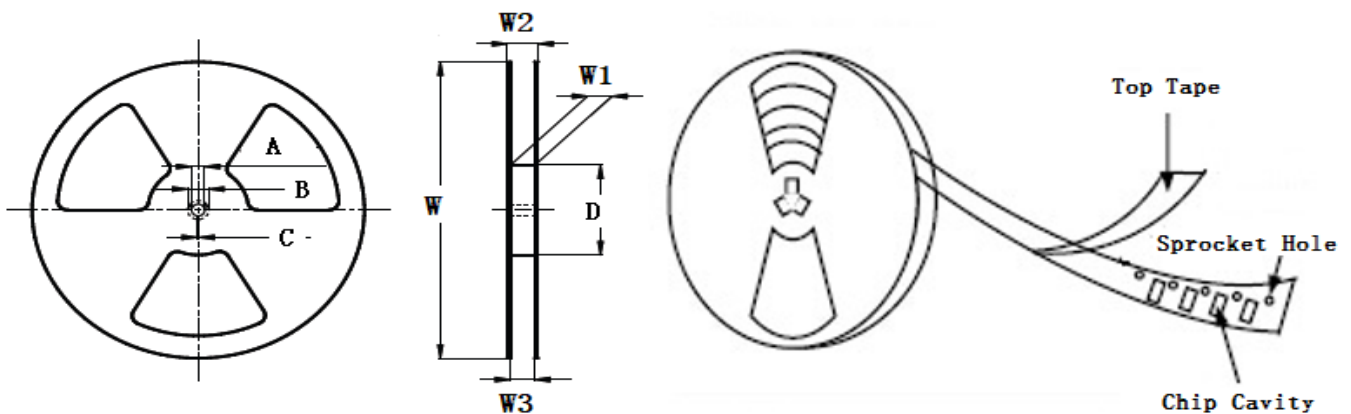

| TYPE | W | W1 | W2 | W3 | A | B | C | D |
|------------|---------|----------|---------|----------|----------|----------|---------|--------|
| YSPIT1508A | 330±2.0 | 32.4±2.0 | 38.4MAX | 31.9 Min | 13.0±0.5 | 21.0±0.8 | 2.0±0.5 | 97±0.5 |

Direction of rolling

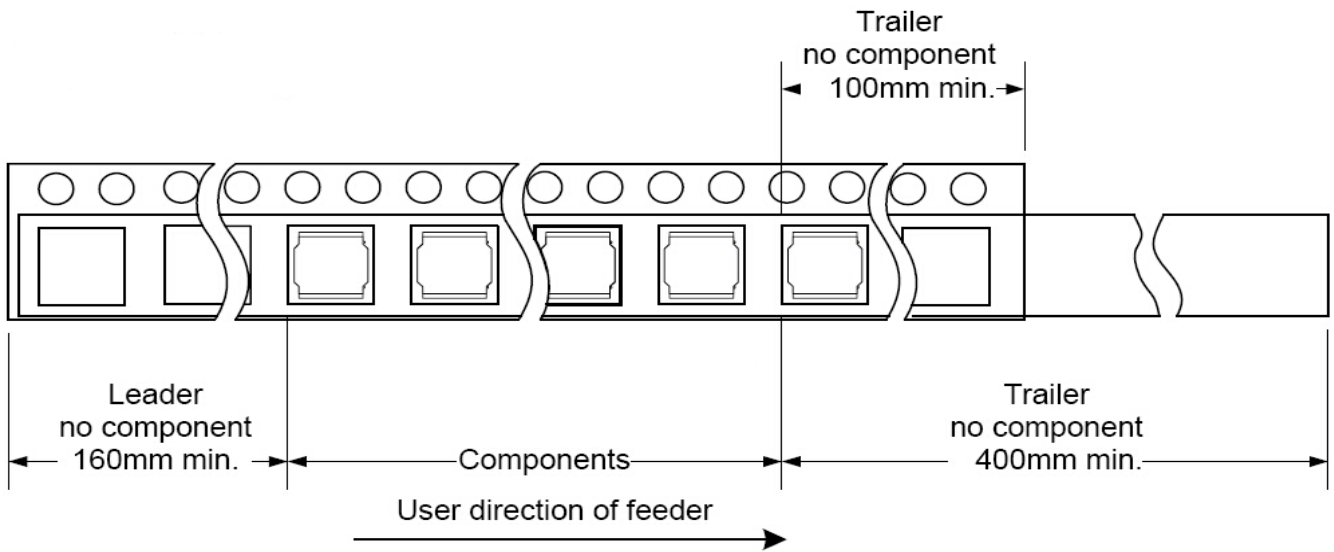

Cover tape peel off condition

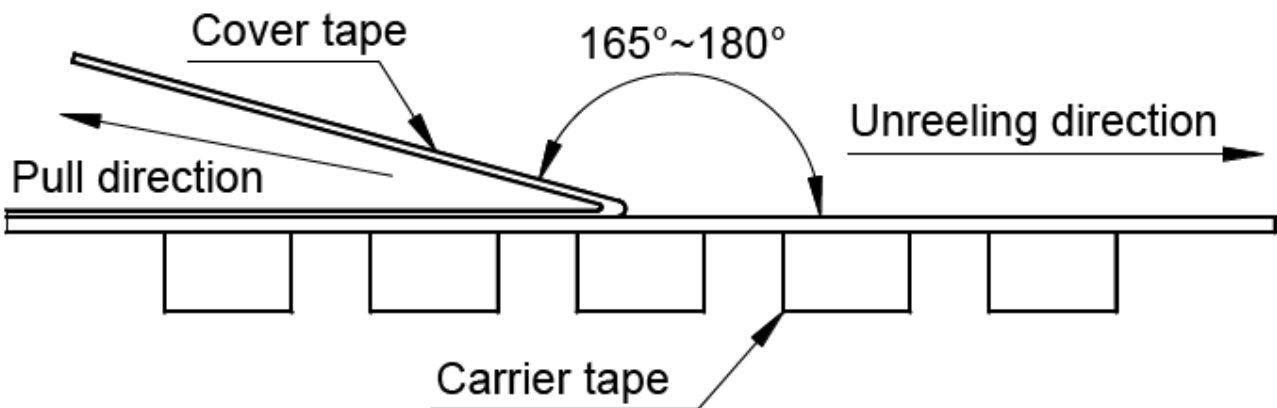

Cover tape peel force shall be 0.1N to 1.3N.

Reference peel speed 300±10mm/min.

X-ON Electronics

Largest Supplier of Electrical and Electronic Components

Click to view similar products for [Fixed Inductors](#) category:

Click to view products by [YJYCOIN](#) manufacturer:

Other Similar products are found below :

[CR32NP-100KC](#) [70F224AI](#) [MHQ1005P10NJ](#) [MHQ1005P1N0S](#) [MHQ1005P2N4S](#) [MHQ1005P3N6S](#) [MHQ1005P5N1S](#) [MHQ1005P8N2J](#)
[PE-53601NL](#) [PE-53602NL](#) [PG0936.113NLT](#) [9220-20](#) [9310-16](#) [PM06-2N7](#) [PM06-39NJ](#) [A01TK](#) [1206CS-471XJ](#) [HC2-R47-R](#) [HC8-1R2-R](#)
[HCF1305-3R3-R](#) [1206CS-151XG](#) [RCH664NP-4R7M](#) [RCP1317NP-391L](#) [DH2280-4R7M](#) [DS1608C-106](#) [B10TJ](#) [B82498B3101J000](#) [ELJ-](#)
[RE27NJF2](#) [1812CS-153XJ](#) [1812CS-183XJ](#) [1812CS-223XJ](#) [1812LS-104XJ](#) [1812LS-105XJ](#) [1812LS-124XJ](#) [1812LS-154XJ](#) [1812LS-223XJ](#)
[1812LS-224XJ](#) [1812LS-563XJ](#) [1812LS-683XJ](#) [1812LS-824XJ](#) [NIN-FB101JTR110F](#) [NIN-FB471JTR62F](#) [NIN-FC1R5JTR220F](#) [NIN-](#)
[HCR15JTRF](#) [NIN-HCR33JTRF](#) [NIN-HDR22JTRF](#) [NIN-HDR82JTRF](#) [NIN-HK2N7STRF](#) [NIN-PA150KTR370F](#) [NIN-PB100KTR550F](#)