



规格书

Aluminum Electrolytic Capacitors

Specification For Approval

| | |
|------------|---------------|
| 客户: | 日期: 2023.9.19 |
| Customer : | Date: |

| | | | |
|-----|--------------|---|----------------------------------|
| 品名 | Item | : | Aluminum Electrolytic Capacitors |
| 型号 | Series | : | KCM |
| 版本 | Version | : | 03 |
| 物料号 | Customer P/N | : | |

| 客户 Customer | | |
|-------------------|------------|-----------|
| 批准 Approved by | 研发部 R&D | 品保部 QC |
| | | |

| 供应商 Supplier | | |
|---|------------------|-------------------|
| 批准 Approved by | 审核 Checked by | 拟制 Prepared by |
| <div style="border: 2px solid red; padding: 5px; display: inline-block;"> 上海永铭电子股份有限公司 工程技术部 邹小丽 梁鹏飞 刘则曼 </div> | | |

承认书请寄回一份

Please Return One Copy with Your Approval

上海永铭电子股份有限公司

Shanghai Yongming Electronic Co., Ltd.

| | | |
|---|--|--|
| 上海永铭电子股份有限公司 Shanghai Yongming Electronic Co.,Ltd. | 铝电解电容器承认书 Aluminum Electrolytic Capacitors Specification | 商标  |
|---|--|--|

| 版本 Version | 日期 Date | 标志 Mark | 页码 Page | 内容 Content | 目的 Aim | 设计 Design | 审核 Checked |
|---------------|------------|------------|------------|---------------|-----------|--------------|---------------|
| | | | | | | | |
| | | | | | | | |

| | | | |
|-------------------------|----------------------|------------|---|
| 名称 Name | 承认书 Specification | | |
| 版本 Version | 03 | 页数 Page | 2 |
| 标准指南 Standard manual | | | |

客户名 Customer

系列
SERIES

KCM

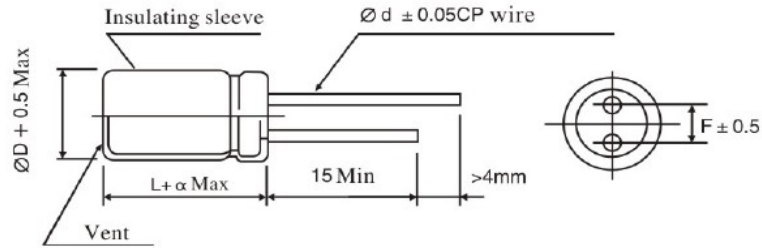

Remark: capacitors with diameter more than 6.3 have safety vent

FIG-1

| | | | | | | | | |
|---|------------------|-----|------------------|-----|-----|------|-----|-----|
| D | 5 | 6.3 | 8 | | 10 | 12.5 | 16 | 18 |
| d | 0.5 | 0.5 | 0.5 | 0.6 | 0.6 | 0.6 | 0.8 | 0.8 |
| F | 2.0 | 2.5 | 3.5 | | 5.0 | 5.0 | 7.5 | 7.5 |
| a | L < 20 a = ± 1.0 | | L ≥ 20 a = ± 2.0 | | | | | |

TABLE-1

| No | 客户物料 编码 Customer Part No | 永铭物 料编码 Ymin Part No | 额定 电压 Rated Voltage (V.DC) | 容量 Capacitance (µF) | 浪涌 电压 Surge Voltage (V.DC) | 使用温度 范围 Operating Temp.Range (°C) | 容量范围 Capacitance Tolerance (%) 25±2°C 120Hz | 损耗 Tanδ (Max) (%) 25±2°C 120Hz | 阻抗 Impedance (Ω) Max at 25±2°C100K Hz | 最大纹波电流 (105°C100KHz) Max Ripple Current(mA) at 105°C100KHz | 漏电流 Leakage Current (µA)(2mins reading) | 寿命 Life At 105°C (HOURS) | 尺寸 Dimensions(mm) | | | | |
|----|-----------------------------------|-------------------------------|--|---------------------------|--|---|--|---|--|--|---|-----------------------------------|-------------------|----|-----|-----|-----|
| | | | | | | | | | | | | | ΦD | L | α | d | F |
| 1 | | KCML2502G820MF | 400 | 82 | 450 | -40~+105 | -20~+20% | 15 | 1.40 | 850 | 502 | 3000 | 12.5 | 25 | 2.0 | 0.6 | 5.0 |
| 2 | | | | | | | | | | | | | | | | | |
| 3 | | | | | | | | | | | | | | | | | |
| 4 | | | | | | | | | | | | | | | | | |
| 5 | | | | | | | | | | | | | | | | | |
| 6 | | | | | | | | | | | | | | | | | |

| | | |
|---|--|--|
| 上海永铭电子股份有限公司 Shanghai Yongming Electronic Co.,Ltd. | 铝电解电容器承认书 Aluminum Electrolytic Capacitors Specification | 商标  |
|---|--|--|

1 概述 SCOPE

本承认书规定了径向引线引出铝电解电容器的技术规范。

This specification covers miniature single-ended aluminum electrolytic capacitors.

2 参考标准 APPLICABLE SPECIFICATION

本承认书参考 JISC-5141 和 JISC-5102 制定。

This approval sheet consulted the institute of JISC-5141 and JISC-5102.

3 工作温度范围 OPERATING TEMPERATURE RANGE

工作温度范围是电容器在施加额定工作电压和额定纹波电流的条件下，可以长期可靠工作的环境温度范围。

-40~+105 °C (400~500V.DC)

Operating temperature range is the range of ambient temperature at which the capacitors can be operated continuously at rated voltage.

-40~+105°C (400~500V.DC)

4 测试环境 CHARACTERISTICS

如果没有其他规定，标准的测试、检验环境条件如下所示：

环境温度：15~35°C

相对湿度：60~70%

大气压力：86kpa~106kpa

如果对测试结果有异议，可以在以下条件测试：环境温度：

20°C±1°C

相对湿度：60%~70%

大气压力：86kpa~106kpa

Unless otherwise specified, the standard range of atmospheric conditions for making measurements and tests are as follows.

Ambient temperature : 15 to 35°C

Relative humidity : 60 to 70%

Air pressure : 86kpa to 106kpa

If there may be doubt on the results, measurements shall be made within the following limits

Ambient temperature : 20±1°C

Relative humidity : 60% to 67%

Air pressure : 86kpa to 106kpa

5. 产品特性 PRODUCT CHARACTERISTICS

5.1 电气特性 ELECTRICAL CHARACTERISTICS

| 序号 NO | 项目 Item | 测试方法 Test method | 性能 Performance |
|----------|-----------------|---------------------|-------------------|
| 5.1.1 | 额定工作电压 Rated | | 400~500 V.DC |

| | | | |
|-------------------------|----------------------|------------|---|
| 名称 Name | 承认书 Specification | | |
| 版本 Version | 03 | 页数 Page | 4 |
| 标准指南 Standard manual | | | |

| | | |
|---|--|--|
| 上海永铭电子股份有限公司 Shanghai Yongming Electronic Co.,Ltd. | 铝电解电容器承认书 Aluminum Electrolytic Capacitors Specification | 商标  |
|---|--|--|

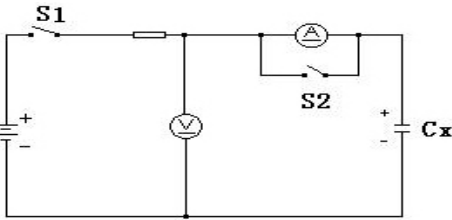
| | | | |
|-------|--------------------------------|--|---|
| | voltage | | |
| 5.1.2 | 电容量 Capacitance | 测试频率: 120Hz±20% 测试电路: 串联等效电路 测试电压: 0.3Vrms Measuring frequency: 120Hz±20% Measuring circuit: Series equivalent circuit Measuring voltage: 0.3Vrms | 标称容量 0.47~10000uF -20%~+20% Range of Capacitance: 容量偏差: -20%~+20% Capacitance tolerance: -20%~+20% |
| 5.1.3 | 损失角正切 Dissipation Factor | 测试条件与 5.1.2 电容量测试相同 Testing condition are the same as 5.1.2 for capacitance | 见表 1 see table 1 |
| 5.1. | 漏电流 Leakage current | 在电容器两端施加额定工作电压，并串联 1000±100Ω 电阻， 在施加电压 2 分钟后，测量漏电流。 测试电路如下图： The rated voltage shall be applied across the capacitors and its protective resistor which shall be 1000±100Ω. The leakage current shall then be measured after an electrification period of 2 min.. Measurement circuit  Rs: 保护电阻 (1000±100Ω) Protective resistor(1000±100Ω) ⊖: 直流电压表 ⊖: DC voltmeter ⊕: 直流电流表 ⊕: DC ammeter S1: 开关 S1: Switch S2: 电流表保护开关 S2: Protective switch for an ammeter | 施加额定工作电压 2 分钟后 The leakage current shall then be measured after an electrification period of 2 min.. 10~100 V.DC $L_c \leq 0.01CV$ 或 $3\mu A$ 取大者 whichever is greater 160~500 V.DC $L_c \leq 0.015CV + 10$ L_c : 漏电流(μA) C : 容量(μF) V : 额定工作电压 (V) L_c : Leakage current(μA) C : Capacitance(μF) V : Rated voltage(V) |

| | | | | |
|------|---------|-----------------|-----|---------------|
| 名称 | Name | | 承认书 | Specification |
| 版本 | Version | 03 | 页数 | Page 5 |
| 标准指南 | | Standard manual | | |

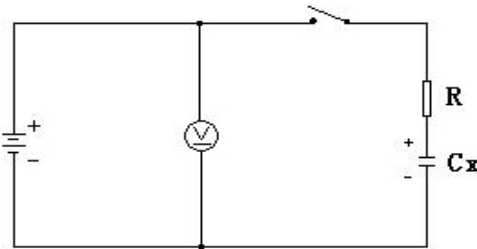
| 5.1.5 | 温度特性 Temperature Characteristic | <table border="1" style="width:100%; border-collapse: collapse; margin-bottom: 10px;"> <thead> <tr> <th style="width:15%;">阶段</th> <th style="width:45%;">温度</th> <th style="width:40%;">时间</th> </tr> </thead> <tbody> <tr> <td style="text-align: center;">1</td> <td style="text-align: center;">$20 \pm 2^{\circ}\text{C}$</td> <td style="text-align: center;">--</td> </tr> <tr> <td style="text-align: center;">2</td> <td style="text-align: center;">-40_{-3}^{+0}C</td> <td style="text-align: center;">2h</td> </tr> <tr> <td style="text-align: center;">3</td> <td style="text-align: center;">$20 \pm 2^{\circ}\text{C}$</td> <td style="text-align: center;">15min.</td> </tr> <tr> <td style="text-align: center;">4</td> <td style="text-align: center;">105_{-0}^{+3}C</td> <td style="text-align: center;">2h</td> </tr> </tbody> </table> <p>阶段 1: 测量容量和阻抗 (z 20°C $120\text{Hz} \pm 20\%$)</p> <p>阶段 2: 电容器恒温贮存 2 小时, 在热平衡状态测阻抗 (-40°C $120\text{Hz} \pm 20\%$)</p> <p>阶段 4: 电容器恒温贮存 2 小时, 在热平衡状态测电容量 Step 1: Capacitance and impedance shall be measured. (z 20°C $120\text{Hz} \pm 20\%$) Step 2: After the capacitors being stored for 2 hours, impedance shall be made at thermal stability. (-40°C $120\text{Hz} \pm 20\%$) Step 4: After the capacitors being stored for 2 hours at 105°C, capacitance shall be measured. The measurement shall be made at thermal stability</p> | 阶段 | 温度 | 时间 | 1 | $20 \pm 2^{\circ}\text{C}$ | -- | 2 | -40_{-3}^{+0}C | 2h | 3 | $20 \pm 2^{\circ}\text{C}$ | 15min. | 4 | 105_{-0}^{+3}C | 2h | <p>阶段 2: 阻抗值与阶段 1 阻抗值相比, 不大于表 2 要求。</p> <p>阶段 4: 容量变化应在初值的 $\pm 20\%$ 范围内</p> <p>Step 2: Impedance value ratio to the value at step 1 shall be not more than the value given table-2</p> <p>Step 4: Variation of capacitance Within $\pm 20\%$ of the value at Step 1.</p> |
|-------|---------------------------------------|--|---|----|----|---|----------------------------|----|---|-------------------------|----|---|----------------------------|--------|---|-------------------------|----|--|
| 阶段 | 温度 | 时间 | | | | | | | | | | | | | | | | |
| 1 | $20 \pm 2^{\circ}\text{C}$ | -- | | | | | | | | | | | | | | | | |
| 2 | -40_{-3}^{+0}C | 2h | | | | | | | | | | | | | | | | |
| 3 | $20 \pm 2^{\circ}\text{C}$ | 15min. | | | | | | | | | | | | | | | | |
| 4 | 105_{-0}^{+3}C | 2h | | | | | | | | | | | | | | | | |
| 5.1.6 | 耐浪涌电压 Surge Test | <p>充电 30 ± 5 秒, 放电 5.5 ± 0.5 分钟作为一个周期, 共进行 1000 次。</p> <p>测试温度: $15^{\circ}\text{C} - 35^{\circ}\text{C}$</p> <p>然后在标准大气条件下放置达到热稳定, 测试各参数 1000 times of charging for 30 ± 5 sec., with a period of 5.5 ± 0.5 min.</p> <p>Test temperature: $15^{\circ}\text{C} - 35^{\circ}\text{C}$</p> <p>And the capacitors shall be stored under standard atmospheric conditions to obtain thermal stability, after which measurements shall be made.</p> <p>测试回路 Test circuit</p> <div style="text-align: center; margin-top: 10px;">  </div> | <p>容量: 在初始值的 $\pm 20\%$ 以内。</p> <p>损耗角正切值: 不大于规定值的 200%。</p> <p>漏电流: 不大于规定值。</p> <p>Capacitance: With $\pm 20\%$ of the initial value</p> <p>Dissipation factor: Not more 200% of the specified value</p> <p>Leakage current: Not more than the specified value</p> | | | | | | | | | | | | | | | |

instantaneous over voltage which may be applied to terminals of capacitors, therefore, not applicable to such over voltages as often applied.

浪涌电压设定

| | | | | | |
|--------|-----|-----|-----|--|--|
| RV(V) | 400 | 450 | 500 | | |
| S.V(V) | 450 | 500 | 550 | | |

5.2 机械特性 MECHANICAL PERFORMANCE

| 序号 NO | 项目 Item | 测试方法 Test method | 特性 Performance | | | | | | | | | | | | | | | | |
|----------|---------------------------------|---|---|-----|-----|-----|------|---|----|--|-------|-----|-----|-----|------|-----|---|--|--|
| 5.2.1 | 端子强度 TERMINAL STRENGTH | 端子抗拉强度： 沿电容器端子引线方向施加*1N 的拉力，10 ±1 秒。 <table border="1" style="width:100%; border-collapse: collapse; margin: 5px 0;"> <tr> <td style="width:15%;">引线直径Φ</td> <td style="width:15%;">0.5</td> <td style="width:15%;">0.6</td> <td style="width:15%;">0.8</td> </tr> <tr> <td>拉力 N</td> <td>5</td> <td>10</td> <td></td> </tr> </table> 端子抗弯强度： 在电容器引线施加固定重力*1N，然后，将电容体弯折 90° 后回到原位，再向相反方向弯折 90° 后回到原位。 上述过程在 5 秒内完成。 <table border="1" style="width:100%; border-collapse: collapse; margin: 5px 0;"> <tr> <td style="width:15%;">引线直径Φ</td> <td style="width:15%;">0.5</td> <td style="width:15%;">0.6</td> <td style="width:15%;">0.8</td> </tr> <tr> <td>拉力 N</td> <td>2.5</td> <td>5</td> <td></td> </tr> </table> Tensile strength of termination: A static load of 1N shall be applied to the terminal in the down-lead direction Bending strength of termination: A static load of 1N applied to the lead wire, then bent the body through 90°, return to the original position. Next bent it in opposite direction through 90° with the same speed, again return to the original position. Carry out this operation in about 5 sec. | 引线直径Φ | 0.5 | 0.6 | 0.8 | 拉力 N | 5 | 10 | | 引线直径Φ | 0.5 | 0.6 | 0.8 | 拉力 N | 2.5 | 5 | | 测量电容器应无接触不良、开路或短路，无可见机械损伤 When the capacitors is measured, there shall be no intermittent contacts, or open or short-circuiting. There shall be no such mechanical damage. |
| 引线直径Φ | 0.5 | 0.6 | 0.8 | | | | | | | | | | | | | | | | |
| 拉力 N | 5 | 10 | | | | | | | | | | | | | | | | | |
| 引线直径Φ | 0.5 | 0.6 | 0.8 | | | | | | | | | | | | | | | | |
| 拉力 N | 2.5 | 5 | | | | | | | | | | | | | | | | | |
| 5.2.2 | 振动试验 Resistance to Vibration | 依据 JIS C 5102 8.2 和 JIS C 5025 试验。 在 3 个互相垂直的方向分别施加 2 小时振动，共 6 小时 To comply with JIS C 5102 8.2 and JIS C 5025 Direction and duration of vibration: 3 orthogonal directions mutually each for 2 hours, total 6 hours | 测量电容器应无接触不良开路或短路，无可见机械损伤。 When the capacitors is measured there shall be no intermittent contacts, or open or short circuiting There shall be no such mechanical damage. | | | | | | | | | | | | | | | | |
| 5.2.3 | 可焊性 Solderability | 依据 IEC60068-2-2 进行试验 焊锡温度：250±5℃ 浸入时间：2.0±0.5 秒 To comply with IEC60068-2-2 Temperature or solder: 250±5℃ Dipping time: 2±0.5sec. | 浸入焊锡的引线表面积约 90% 以上应附着新锡 At least 90% of circumferential surface of the dipping portion of termination shall be covered with new solder. | | | | | | | | | | | | | | | | |

| | | |
|---|--|--|
| 上海永铭电子股份有限公司 Shanghai Yongming Electronic Co.,Ltd. | 铝电解电容器承认书 Aluminum Electrolytic Capacitors Specification | 商标  |
|---|--|--|

5.3 耐久性测试 ENDURANCE PERFORMANCE

| 序号 NO | 项目 Item | 测试方法 Test method | 特性 Performance | | | | | |
|----------|--|--|---|-------|-------|-----|-------|---|
| 5.3.1 | 耐焊接热 Resistance to old ring heat | 焊槽法： 焊锡温度：260±5℃ 浸入时间：10±1 秒 电路板：1.6mm Solder bath method Solder temperature : 260±5℃ Immersion time : 10±1sec. Printed wiring board: 1.6mm | 容量变化：在初始值±10%范围内 损失角正切值：不大于规定值 漏电流：满足 5.1.4 要求 外观：无异状 Variation of capacitance: Within ±10% of the initial value before test. Dissipation factor: Not more than the specified value Leakage current: To satisfy No.5.1.4 Appearance: No remarkable abnormality. | | | | | |
| 5.3.2 | 稳态湿热 Resistance to damp heat (steady state) | 依据 JIS C 5023 进行试验 试验温度：40±2℃ 试验时间：240±8h 相对湿度：90~95% 试验后，电容器在标准大气条件下 1~2 小时，然后测试参数 To comply with JIS C 5023 Test temperature : 40±2℃ Test time : 240±8h Relative humidity: 90~95% After completion of test, the capacitors shall be subjected to standard atmospheric conditions for 1 to 2 hours, after which measurements shall be made. | 容量变化：在初始值±15%范围内 损失角正切值：不大于规定值% 漏电流：满足 5.1.4 要求 外观：无异状 Variation of capacitance: Within ±15% of the initial value before test. Dissipation factor: Not more than the specified value Leakage current: To satisfy No.5.1.4 Appearance: No remarkable abnormality. | | | | | |
| 5.3.3 | 高温负荷试验 Load life test | 1 试验温度：105±2℃，施加含额定纹波电流的额定电压(所加电压峰值不超过)，Apply rated voltage with rated ripple current.(the peak voltage shall not exceed the rated voltage) Test temperature:105±2℃ 2 产品置于常温 16 小时后测试，测试温度 25±2℃，电容器的性能应满足如下要求 <table border="1" style="margin-left: 20px;"> <tr> <td rowspan="2" style="text-align: center;">负荷 寿命</td> <td style="text-align: center;">≤Φ6.3</td> <td style="text-align: center;">2000H</td> </tr> <tr> <td style="text-align: center;">≥Φ8</td> <td style="text-align: center;">3000H</td> </tr> </table> | 负荷 寿命 | ≤Φ6.3 | 2000H | ≥Φ8 | 3000H | 容量变化：在初始值±20%范围内 损耗角正切值：不超过规定值的 200% 漏电流：在规定值以内 外观：无异状 Variation of capacitance: Within±20%of the initial value before test. Dissipation factor: Within 200% of the specified value Leakage current: Within the specified value Appearance: No remarkable abnormality. |
| 负荷 寿命 | ≤Φ6.3 | 2000H | | | | | | |
| | ≥Φ8 | 3000H | | | | | | |

| | | | |
|-------------------------|----------------------|------------|---|
| 名称 Name | 承认书 Specification | | |
| 版本 Version | 03 | 页数 Page | 8 |
| 标准指南 Standard manual | | | |

| | | |
|---|--|--|
| 上海永铭电子股份有限公司 Shanghai Yongming Electronic Co.,Ltd. | 铝电解电容器承认书 Aluminum Electrolytic Capacitors Specification | 商标  |
|---|--|--|

| | | | |
|-------|-------------------------------|---|---|
| 5.3.4 | 高温贮存试验 Shelf life test | 在 105±2°C环境下无负荷贮存 1000 h，至少恢复 16 小时。 The capacitors are then stored with no voltage applied at a temperature of 105±2°Cfor 1000 hours and then resumed 16 hours. | 容量变化率：初始值±20%范围内。 损耗角正切值：不超过规定值的 200% 漏电流：不超过规定值的 200% 外观：无异状 Variation of capacitance: Within ±20% of the initial value before test. Dissipation factor: Not more than 200% of the specified value Leakage current: Not more than 200% of the specified value Appearance: No remarkable abnormality. |
| 5.3.5 | 低温储存： Low temperature storage | 环境温度 -40°C±2°C ambient temperature -40°C±2°C 持续时间：240 小时 Time: 240 Hours 恢复时间：至少 16 小时 Recovery time: at least 16 hours | 100Hz 下测试，电容量变化率 $\Delta C/C \leq \pm 20\%$; Test at 100HZ, capacitance change $\Delta C/C \leq \pm 20\%$; 100Hz 下测试，损耗 $tg\delta \leq$ 规格值； Test at 100HZ, DF $tg\delta \leq$ specified value 漏电流 \leq 规格值； Leakage current \leq specified value 试验后电容器无可见损伤和电解质漏出。 No visible damage and electrolytic leakage after testing capacitor. |
| 5.3.6 | 防爆试验 Safety vent | 在电容器两极施加直流反向电压 100V，其中通过的电流设置应不大于 1A，在测试时防爆装置应能在 30 分钟内动作。 D. C. Application test The capacitors shall be subjected to a reverse D.C.100 voltage equal to the rated D.C.voltage. The current flowing through the capacitors shall be limited to 1A. If the vent does operate with the voltage applied for 30 minutes, the test is considered to be passed. | 上述过程中应无引线、铝箔等散射，无火花产生。 The vent device is actuated under the test conditions, thereby preventing terminals, metal pieces, etc, of the capacitors from scattering due to burst, the case from separating from the seal packing, or the capacitors from producing flame. |

| | | | | |
|----------------------|---------|-------------------|---------|---|
| 名称 | Name | 承认书 Specification | | |
| 版本 | Version | 03 | 页数 Page | 9 |
| 标准指南 Standard manual | | | | |

| | | |
|---|--|--|
| 上海永铭电子股份有限公司 Shanghai Yongming Electronic Co.,Ltd. | 铝电解电容器承认书 Aluminum Electrolytic Capacitors Specification | 商标  |
|---|--|--|

表2 Table 2



| | | | | | | | | |
|---------------------------------|-----------------------------|-----|-----|-----|--|--|--|--|
| 阻抗比 (120HZ) | 额定工作电压 Rstед voltage (v) | 400 | 450 | 500 | | | | |
| Max. impedance ratio (120HZ) | z -40°C/ z 20°C | 7 | 9 | 9 | | | | |

6. 标记 MARKING

6. 1 在电容器体上注明有如下内容:

- (1) 生产厂商商标 
- (2) 工作电压
- (3) 型号规格
- (4) 负极标志 
- (5) 额定温度
- (6) 生产周期 A13(13表示年份, A表示月份; A~M 表示: 1月~12月, I 除外)

The following items shall be marked indelibly on the capacitors.

- (1) Manufacture' s name or trade mark. 
- (2) Rated voltage
- (3) Type and specification
- (4) Polarity of the terminals 
- (5) Rated temperature
- (6) Manufacture time A13(13 that year, A said that the month , A ~ M said: January ~ December ,except I)

6. 2 标记颜色

套管颜色: 咖啡色
Marking color
Sleeve color : **Coffee color**

| | | | | |
|------|---------|-----------------|----|---------------|
| 名称 | Name | 承认书 | | Specification |
| 版本 | Version | 03 | 页数 | Page 10 |
| 标准指南 | | Standard manual | | |

| | | |
|---|--|--|
| 上海永铭电子股份有限公司 Shanghai Yongming Electronic Co.,Ltd. | 铝电解电容器承认书 Aluminum Electrolytic Capacitors Specification | 商标  |
|---|--|--|

7. 纹波电流补偿系数 Ripple Current Correction Factor

7.1 频率修正系数 Frequency correction factor

| | | | | | |
|---------------------------|------|------|------|---------|------|
| 频率 (Hz) Frequency (Hz) | 50 | 120 | 1K | 10K~50K | 100K |
| 修正因子 Correction Factor | 0.40 | 0.50 | 0.80 | 0.90 | 1.00 |

8. 包装 PACKING

8.1 包装标签 PACKING LABEL

内标签样本 inner label sample

外箱标签样本 outer label sample



包装标签内容 Packing Label Marked (the following items shall be marked on the label)

(Inside box or bag、outer box)

- 1) 产品名称 Product name
- 2) 生产批号 Lot No
- 3) 数量 quantity
- 4) 生产日期 Production date
- 5) 产品编号 Part No
- 6) 客户物料描述 Customer item code

8.2 批号 Lot number:

| | | | | | | | | | | | | |
|----------|----------|----------|---------------|-------------------|----------|----------|---------------|----------|-----------|-----------|-----------|-----------|
| <u>1</u> | <u>2</u> | <u>3</u> | <u>4</u> | <u>5</u> | <u>6</u> | <u>7</u> | <u>8</u> | <u>9</u> | <u>10</u> | <u>11</u> | <u>12</u> | <u>13</u> |
| 商标 | 年 | 月 | 材料标识 | 生产序号 | | | 分箱号 | | | | | |
| YM | year | moth | material code | production number | | | serial number | | | | | |

8.3 散包装按下图包装方式 Bulk Packing

| | | | | |
|------|---------|-----------------|----|---------------|
| 名称 | Name | 承认书 | | Specification |
| 版本 | Version | 03 | 页数 | Page 11 |
| 标准指南 | | Standard manual | | |



内包装盒 Box



外包装箱 Carton

9. 切脚、成型 Lead cutting and forming

切脚、成型标准 Standard for lead cutting

该标准是用于引线切脚，技术要求，判断和验收。

This standard is used for lead cutting, technology, requirement, judgment and acceptance inspection, and etc.

引线切脚 A 图

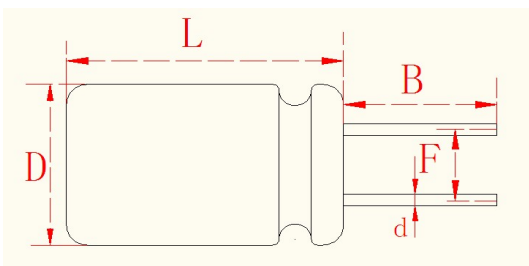

| | | | | | | | | |
|---|--------|-----|-----|-----|------|-----|-------|------|
| D | 5 | 6.3 | 8 | 10 | 12.5 | 16 | 18 | 公差 |
| B | 2.5~10 | | | | | | | ±0.5 |
| d | 0.5 | | 0.6 | | 0.8 | | ±0.05 | |
| F | 2.0 | 2.5 | 3.5 | 5.0 | | 7.5 | ±0.5 | |

引线切脚成型 B 图

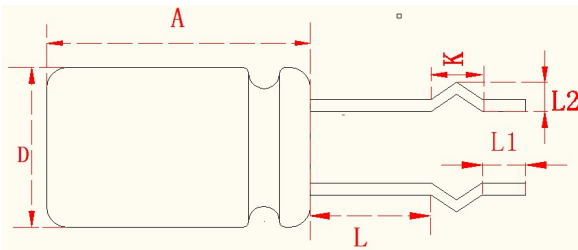

| | | | | | | |
|------------|-----|--------|-------|--------|-------------|----------|
| D | A | L±0.5 | K±0.5 | L2±0.3 | L1±0.5 | 备注 |
| ≤Φ 12.5 | ≤25 | 2.5~22 | 2.5 | 1.5 | 2.0~ 5.0 | 外K 成型 |

引线切脚成型 C 图

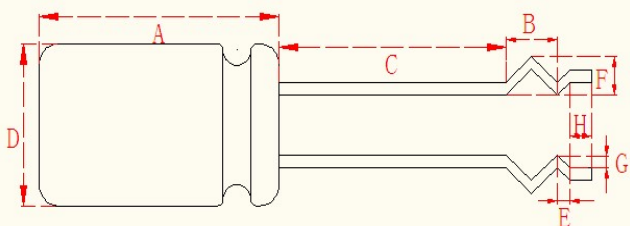

| | | | | | | | | |
|------------|-----|------------|-------|-------|-------|-------|-------------|-----------|
| D | A | C±0.5 | B±0.5 | E±0.3 | F±0.3 | G±0.3 | H±0.5 | 备注 |
| ≤Φ 12.5 | ≤25 | 2.5~ 22 | 3.0 | 1.2 | 1.8 | 0.8 | 2.0~ 5.0 | 内外K 成型 |

引线切脚成型 D 图

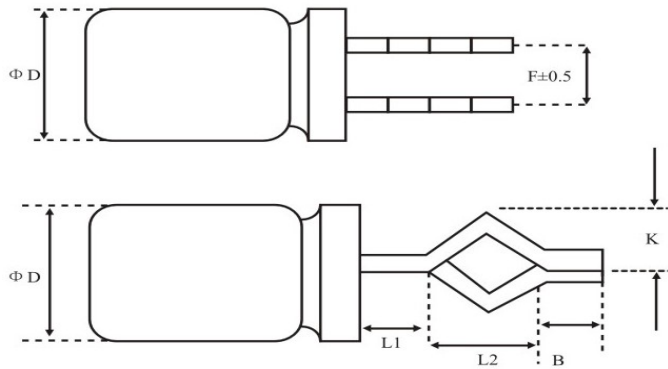

| | | |
|----|----------|------|
| ΦD | 8 | 误差 |
| F | 3.5 | ±0.5 |
| L1 | 2.5~21.0 | ±0.5 |
| L2 | 3.5 | ±0.5 |
| K | 1.2 | ±0.2 |
| B | 1.2 | ±0.5 |

引线切脚成型 E 图

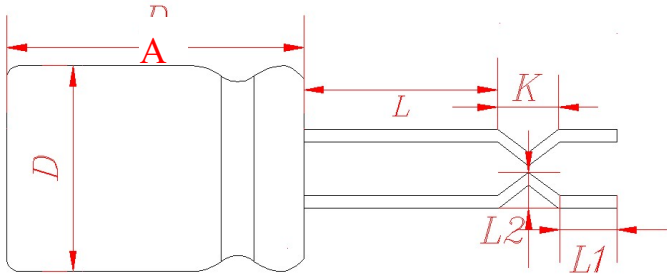

| D | A | L±0.5 | K±0.5 | L2±0.3 | L1±0.5 | 备注 |
|------------|-----|------------|-------|--------|-------------|-----------|
| ≤Φ 12.5 | ≤25 | 2.5~ 22 | 2.5 | 1.5 | 2.0~ 5.0 | 内 K 成型 |

引线切脚成型 F 图 (成型折弯 90°)

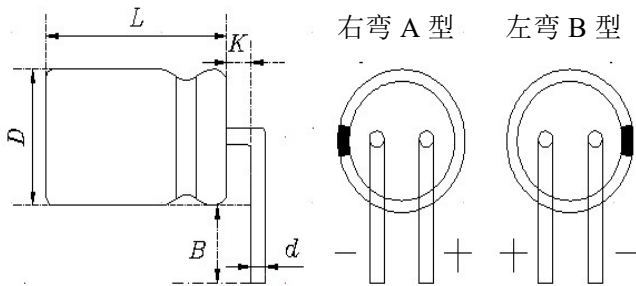

| D | Φ5~Φ12.5 | Φ16~Φ18 | 公差 |
|----|---------------|---------|------|
| K | 2.0 | 2.5 | ±0.5 |
| B | 2.0~10 | | ±0.5 |
| 类型 | 右弯 A 型/左弯 B 型 | | / |

引线切脚成型 G 图

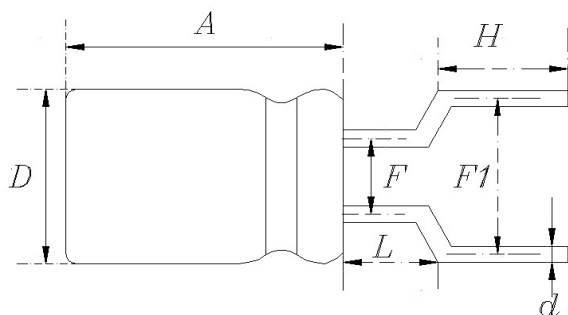

| D | Φ5 | Φ6.3 | Φ8 | 公差 |
|----|--------|------|-----|-------|
| d | 0.5 | 0.5 | 0.6 | ±0.05 |
| F | 2.0 | 2.5 | 3.5 | ±0.5 |
| F1 | 2.5 | 3.5 | 5.0 | ±0.5 |
| L | 2.5 | 2.5 | 2.5 | ±0.5 |
| H | 2.0~10 | | | ±0.5 |

引线切脚成型 H 图 (成型双折弯 90°)

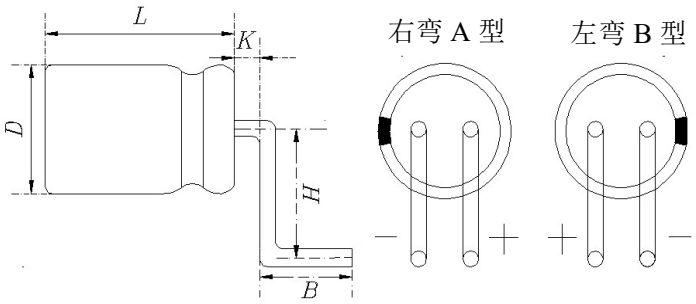

| | | | | | | |
|----|---------------|------|-----|-----|-------|------|
| D | Φ5 | Φ6.3 | Φ8 | Φ10 | Φ12.5 | 公差 |
| K | 2.0 | 2.0 | 2.0 | 2.0 | 2.0 | ±0.5 |
| H | 7.0 | 7.0 | 7.0 | 7.0 | 7.0 | ±0.5 |
| B | 2.0~10 | | | | | ±0.5 |
| 类型 | 右弯 A 型/左弯 B 型 | | | | | / |

编带外型尺寸 A 图

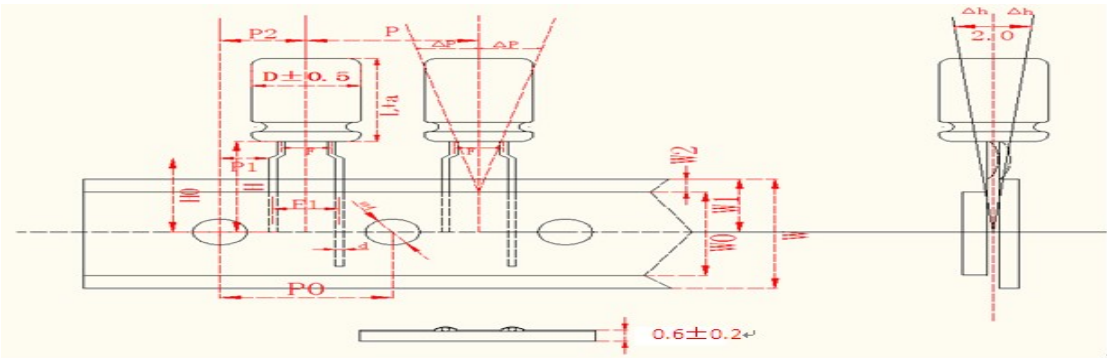

编带外型尺寸 B 图

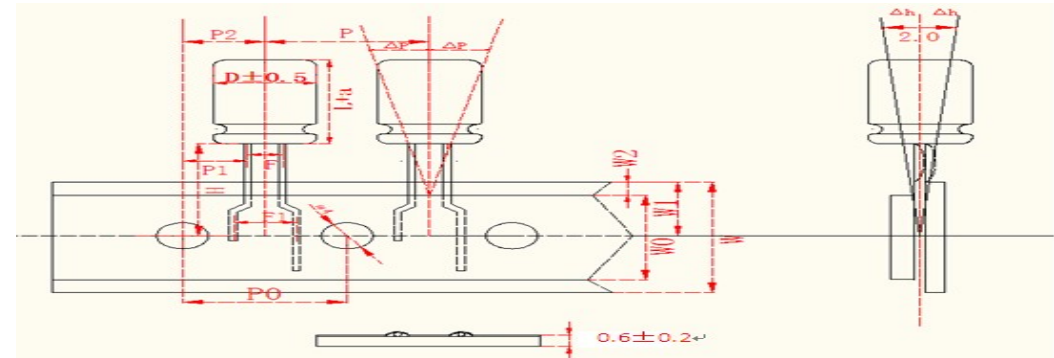

Ψ0-Ψ0

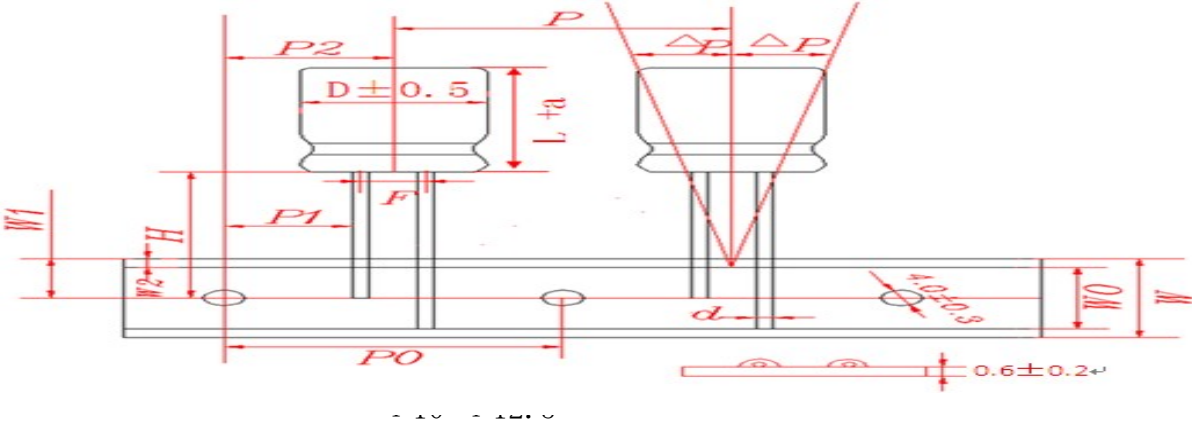

编带规格表:

| 项目 | 记号 | Φ5 | | | | Φ6.3 | | Φ8 | | Φ10 | Φ12.5 | 允许差 | |
|---------|-----|---------|-----|-----|------|------|------|------|------|-----|-------|-----------|------|
| | | U1 | U4 | U5 | T1 | U2 | T2 | U3 | T3 | T4 | T5 | | |
| 引线加工记号 | | 图 A | 图 A | 图 A | 图 B | 图 A | 图 B | 图 A | 图 B | 图 B | 图 B | | |
| 形状尺寸图 | | 图 A | 图 A | 图 A | 图 B | 图 A | 图 B | 图 A | 图 B | 图 B | 图 B | | |
| 引线直径 | Φd | 0.5 | | | | | 0.6 | | | | | ±0.05 | |
| 主体间距 | P | 12.7 | | | | | | | | 15 | | ±1.0 | |
| 穿孔间距 | P0 | 12.7 | | | | | | | | 15 | | ±0.2 | |
| 穿孔与引线间距 | P1 | 3.85 | | | 4.35 | 3.85 | 4.35 | 3.85 | 4.35 | 5 | | ±0.7 | |
| 穿孔与主体间距 | P2 | 6.35 | | | | | | | | 7.5 | | ±1.0 | |
| 引线间距 | F1 | 5.0 | 2.5 | 3.5 | 5.0 | 5.0 | 5.0 | 5.0 | 5.0 | 5.0 | | +0.8~-0.2 | |
| 引线间距 | F | 2.0 | | | | 2.5 | | 3.5 | | 5.0 | | | ±0.5 |
| 衬纸宽度 | W | 18.0 | | | | | | | | | | ±0.3 | |
| 胶带宽度 | W0 | 12.5 | | | | | | | | | | MIN | |
| 穿孔与衬纸间距 | W1 | 9.0 | | | | | | | | | | ±0.5 | |
| 胶带与衬纸间距 | W2 | 0.5~2.0 | | | | | | | | | | / | |
| 主体下方位置 | H | 18.5 | | | | | | | | | | ±0.75 | |
| 引线弯曲高度 | H0 | 16 | | | -- | 16 | -- | 16 | -- | | | ±0.5 | |
| 穿孔直径 | ΦD0 | 4.0 | | | | | | | | | | ±0.3 | |
| 主体倾斜度 | △h | 1.0 | | | | | | | | | | MAX | |
| 主体倾斜度 | △p | 1.0 | | | | | | | | | | MAX | |
| 编带总厚度 | t | 0.6 | | | | | | | | | | ±0.2 | |
| 最小包装数量 | | 2100 | | | | 1700 | | 1000 | | 672 | 440 | | |

11. 产品编码规则

Product Code Rules

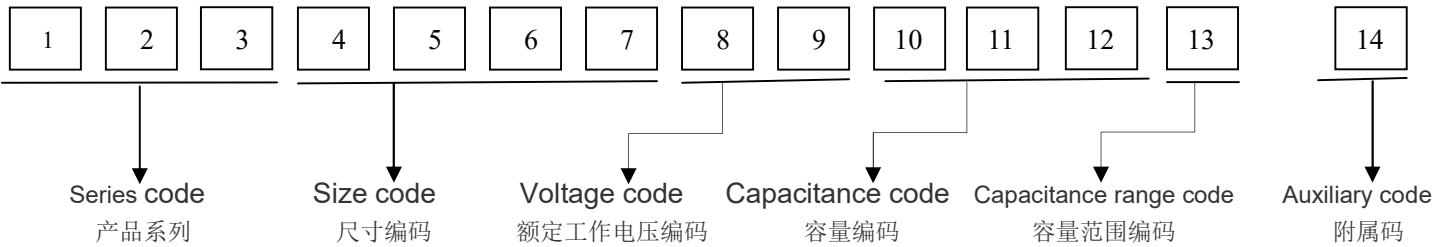

| 产品系列 | |
|------|------|
| 系列 | 编码 |
| LMM | LMM |
| L3M | L3M |
| L4M | L4M |
| LK7 | LK7 |
| LK | OLK |
| LKF | LKF |
| LKG | LKG |
| LKL | LKL |
| LLK | LLK |
| GP | OGP |
| LKM | LKM |
| LKZ | LKZ |
| KC | OKC |
| KCX | KCX |
| KCD | KCD |
| KCG | KCG |
| PKC | PKC |
| LKJ | LKJ |
| LKX | LKX |
| VK7 | VK7 |
| VKO | VKO |
| VKG | VKG |
| VKL | VKL |
| VKM | VKM |
| VMM | VMM |
| V3M | V3M |
| V3MC | V3MC |
| V4M | V4M |
| | |
| | |

| 额定工作电压 | |
|--------|----|
| 电压 | 编码 |
| 4V | 0G |
| 6.3V | 0J |
| 7.5V | 0L |
| 10V | 1A |
| 16V | 1C |
| 20V | 1D |
| 25V | 1E |
| 30V | 1P |
| 35V | 1V |
| 40V | 1G |
| 50V | 1H |
| 63V | 1J |
| 80V | 1K |
| 100V | 2A |
| 120V | 2K |
| 160V | 2C |
| 200V | 2D |
| 250V | 2E |
| 350V | 2V |
| 400V | 2G |
| 420V | 2T |
| 450V | 2W |
| 480V | 2L |
| 500V | 2H |
| 550V | 2I |
| 600V | 2J |

| 静电容量 | | | |
|---------|-----|----------|-----|
| 容量 | 编码 | 容量 | 编码 |
| 0.1 μF | 0R1 | 33 μF | 330 |
| 0.22 μF | R22 | 47 μF | 470 |
| 0.33 μF | R33 | 56 μF | 560 |
| 0.47 μF | R47 | 68 μF | 680 |
| 0.68 μF | R68 | 82 μF | 820 |
| 0.82 μF | R82 | 100 μF | 101 |
| 1.0 μF | 1R0 | 120 μF | 121 |
| 1.2 μF | 1R2 | 150 μF | 151 |
| 1.5 μF | 1R5 | 180 μF | 181 |
| 1.8 μF | 1R8 | 220 μF | 221 |
| 2.2 μF | 2R2 | 270 μF | 271 |
| 2.7 μF | 2R7 | 330 μF | 331 |
| 2.8 μF | 2R8 | 470 μF | 471 |
| 3.0 μF | 3R0 | 560 μF | 561 |
| 3.3 μF | 3R3 | 680 μF | 681 |
| 3.6 μF | 3R6 | 820 μF | 821 |
| 3.9 μF | 3R9 | 1000 μF | 102 |
| 4.0 μF | 4R0 | 1200 μF | 122 |
| 4.7 μF | 4R7 | 1500 μF | 152 |
| 5.6 μF | 5R6 | 1800 μF | 182 |
| 6.0 μF | 6R0 | 2200 μF | 222 |
| 6.2 μF | 6R2 | 2700 μF | 272 |
| 6.8 μF | 6R8 | 3300 μF | 332 |
| 8.2 μF | 8R2 | 3900 μF | 392 |
| 10 μF | 100 | 4700 μF | 472 |
| 12 μF | 120 | 5600 μF | 562 |
| 13 μF | 130 | 6800 μF | 682 |
| 15 μF | 150 | 8200 μF | 822 |
| 18 μF | 180 | 10000 μF | 103 |
| 22 μF | 220 | 22000 μF | 223 |
| 27 μF | 270 | 33000 μF | 333 |

| 容量范围 | |
|----------|----|
| 级别 | 编码 |
| ±20% | M |
| ±10% | K |
| 0~+10% | R |
| 0~+10% | T |
| -10~+20% | V |
| -20~+5% | L |
| -10~+5% | G |
| -10~+15% | H |
| 0~+40% | I |
| ±15% | J |
| -20~+50% | A |
| -5~+20% | B |
| -5~+20% | E |
| -15~+5% | C |
| -15~+5% | D |
| 0~+20% | F |
| 0~+15% | N |
| -5~+15% | W |
| -20~+0% | S |
| -20~+10% | P |
| 0~+5% | Q |

| 附属码 | | 附属码 | |
|----------|-------------------------|-----------|------------|
| 附属码 (国内) | | 附属码 (IND) | |
| O | 引线 30F/35F | 2 | 引线 30F/35F |
| H | 引线 33F/38F | 3 | 引线 33F/38F |
| F | 引线 22F/27F | 4 | 切直脚 A 图 |
| A | 切直脚 A 图 | 5 | 切脚成型 B 图 |
| B | 切脚成型 B 图 | 6 | 切脚成型 C 图 |
| C | 切脚成型 C 图 | 7 | 切脚成型 D 图 |
| D | 切脚成型 D 图 | 8 | 切脚成型 E 图 |
| E | 切脚成型 E 图 | 9 | 引线 22F/27F |
| Q | 切脚折弯 90° F 图 A 型 (右) | M | 编带 A 图 |
| P | 切脚折弯 90° F 图 B 型 (左) | N | 编带 B 图 |
| X | 切脚成型 G 图 | | |
| g | 切脚双折弯 90° F 图 A 型 | | |
| f | 切脚双折弯 90° F 图 B 型 | | |
| K | 编带 A 图 | | |
| J | 编带 B 图 | | |
| V | 液态 SMD | | |
| CG | 车规 | | |

外形尺寸

| 产品直径 | 编码 | 产品高度 | 编码 | 产品高度 | 编码 |
|------|----|------|-----|------|-----|
| 3.5 | F | 3.55 | 035 | 15 | 150 |
| 4 | A | 3.95 | 039 | 16 | 160 |
| 4.5 | G | 4.5 | 045 | 16.5 | 165 |
| 5 | B | 5 | 050 | 17 | 170 |
| 5.5 | H | 5.4 | 054 | 18 | 180 |
| 6.3 | C | 5.8 | 058 | 19 | 190 |
| 8 | D | 6.5 | 065 | 20 | 200 |
| 10 | E | 7 | 070 | 21 | 210 |
| 12.5 | L | 7.7 | 077 | 22 | 220 |
| 16 | I | 8 | 080 | 23 | 230 |
| 18 | J | 8.5 | 085 | 25 | 250 |
| 20 | N | 9 | 090 | 28 | 280 |
| 22 | K | 9.5 | 095 | 30 | 300 |
| 25 | M | 10 | 100 | 31.5 | 315 |
| 30 | P | 10.5 | 105 | 32 | 320 |
| 35 | Q | 11 | 110 | 35.5 | 355 |
| 40 | R | 11.5 | 115 | 36 | 360 |
| | | 12 | 120 | 40 | 400 |
| | | 12.5 | 125 | 41.5 | 415 |
| | | 13 | 130 | 45 | 450 |
| | | 13.5 | 135 | 50 | 500 |
| | | 14 | 140 | | |
| | | 14.5 | 145 | | |

| | | |
|---|--|--|
| 上海永铭电子股份有限公司 Shanghai Yongming Electronic Co.,Ltd. | 铝电解电容器承认书 Aluminum Electrolytic Capacitors Specification | 商标  |
|---|--|--|

12. 其他 The others

12.1 铝电解电容器的应用上的重要信息

Important information on the application of aluminum electrolytic capacitors

12.1.1. 电解电容是有极性的 DC electrolytic capacitors are polarized

当施加反向直流电压时，电容器将变为短路，电路中使用没有极化电容会被损坏，因为可施加到正电压的阴极端子的电路中流过异常电流。 When reverse voltage is applied on DC electrolytic capacitors, the capacitors will becomes short-circuited please use no polarized capacitors in the circuit be damage due to abnormal current flows through the capacitors since the circuit where the positive voltage may be applied to the cathode terminal.

12.1.2. 使用电容器额定电压 Use capacitors within rated voltage

当电容器用比额定电压更高的电压时，漏电流增加，特性显着恶化，并在很短的时间内发生损坏的结果。请特别小心的峰值电压不应超过额定电压。 When capacitors is used at higher voltage than the rated voltage, leakage current increases, characteristics drastically deteriorate and damage in a short period may occur as a result. Please take extra caution that the peak voltage should not exceed the rated voltage.

12.1.3. 充电和放电应用 Charge and discharge application.

当铝电解电容器用于快速充电和放电的应用，其寿命可缩短减少，热量上升，等等。

When aluminum electrolytic capacitors for general purpose are employed in rapid charge and discharge application, its life expectancy may be shortened by capacitance decrease, heat rise, etc.

12.1.4. 存储电容器 Store the capacitors.

在已经存储了长时间的铝电容器其漏电流上升是常见的。存储温度越高，漏电流增大，因此，请采取预防措施，如存储位置。有电压被施加到电容器上时其漏电流逐渐减小。漏电流增加，会造成问题，因此，使用前在电路中施加电压（老化）。I creased leakage current is common in aluminum capacitors which have been stored for long period of time. The Higher the storage temperature, the higher the leakage current increase,

therefore please take precautions concerning the storage location. The leakage current decreases gradually as voltage are applied to the capacitor. In cases where increased leakage current causes problems in the circuit, apply voltage (aging) before using.

12.1.5 适用于电容器的纹波电流不应超过额定的值

Ripple current applied to capacitors should not exceed the rated value.

如果纹波电流超过指定值，过多的热量会减少容量和缩短电容寿命。因此纹波电压的峰值应该小于额定电压。

| | | | | |
|----------------------|---------|-------------------|---------|----|
| 名称 | Name | 承认书 Specification | | |
| 版本 | Version | 03 | 页数 Page | 18 |
| 标准指南 Standard manual | | | | |

| | | |
|---|--|--|
| 上海永铭电子股份有限公司 Shanghai Yongming Electronic Co.,Ltd. | 铝电解电容器承认书 Aluminum Electrolytic Capacitors Specification | 商标  |
|---|--|--|

Excessive heat will reduce capacitance and result in shortened life of capacitor if ripple currents exceeding the specified rated value are applied. The peak value of the ripple voltage should be less than the rated voltage.

12.1.6. 环境温度 Ambient temperature.

铝电解电容器的寿命受环境温度的影响。人们普遍表示，温度每下降 10℃寿命加倍。Life of the aluminum electrolytic capacitor is affected by the ambient temperature. It is generally stated, that life doubles for each 10°C decrease in temperature.

12.1.7. 引线的强度 Intensity of lead

加到引线或端子，应力的内部连接。这可能会导致短路，开路或漏电流增加。在电容器已被焊接到 PC 板上后，弯曲或后处理电容器是不可取的。

When a strong force is applied to the lead wires or terminals, stress is put on the internal connections. This may result in short circuit, open circuit or increased leakage current. It is not

12.1.8 在焊接过程中的耐热性 Heat resistance at the soldering process

在 PC 板上安装铝电解电容器的浸焊工艺中，观察到 PET 外套二次收缩或开裂时，焊料的温度太高或浸渍时间太长。advisable to bend or handle a capacitors after it has been soldered to the PC board.

In the dip soldering process of PC board with aluminum electrolytic capacitors mounted, secondary shrinkage or crack of PET sleeve may be observed when solder temperature is too high or dipping time is too long.

12.1.9. PC 板的孔间距和位置 Hole pitch and position of PC board.

设计印刷电路板，其孔距适合指定的目录或规格的电容的引线间距（铅的间距）。当电容器强行插入一个孔间距时，把应力加在引线。这可能会导致短路或漏电流增加。

capacitor specified by the catalog or specifications. When a capacitor is forcibly inserted into an unmatched hole A PC board must be designed so its hole pitch coincides with the lead pitch (lead spacing) of the pitch, a stress is put on the leads. This could result in a short circuit or increased leakage current.

12.2 该产品是无铅和环保 This product is lead free and environmental friendly. (SHAMLP2025931105, SGS)

产品按照 ROHS 的标准，六种有害物质最大不超过下列要求：This products according to the standard of ROHS,it means the max capacitance Of six harmful material not over the following request:

| | | |
|-------------|---------------|----------------|
| Cd -100PPM | Pb -1000PPM | Hg -1000PPM |
| Cr+-1000PPM | PBBs -1000PPM | PBDEs -1000PPM |

| | | | | |
|------|---------|-------------------|----|---------|
| 名称 | Name | 承认书 Specification | | |
| 版本 | Version | 03 | 页数 | Page 19 |
| 标准指南 | | Standard manual | | |

X-ON Electronics

Largest Supplier of Electrical and Electronic Components

Click to view similar products for [Aluminium Electrolytic Capacitors - Radial Leaded](#) category:

Click to view products by [Ymin](#) manufacturer:

Other Similar products are found below :

[LXY50VB4.7M-5X11](#) [RFO-100V471MJ7P#](#) [ECE-A1EGE220](#) [1814181](#) [NCD681K10KVY5PF](#) [NEV1000M25EF-BULK](#) [NEV100M35DC](#)
[NEV100M63DE](#) [NEV220M25DD-BULK](#) [NEV.33M100AA](#) [NEV4700M50HB](#) [NEV.47M100AA](#) [NEVH1.0M250AB](#) [NEVH3.3M250BB](#)
[NEVH3.3M450CC](#) [KME50VB100M-8X11.5](#) [SG220M1CSA-0407](#) [ES5107M016AE1DA](#) [ESX472M16B](#) [476CKH100MSA](#) [477RZS050M](#)
[UVX1V101KPA1FA](#) [UVX1V222MHA1CA](#) [KME25VB100M-6.3X11](#) [VTL100S10](#) [VTL470S10](#) [511D336M250EK5D](#) [052687X](#) [ECE-](#)
[A1CF471](#) [EKXG451ELL820MM30S](#) [686CKR050M](#) [NRE-S560M16V6.3X7TBSTF](#) [ERZA630VHN182UP54N](#) [UPL1A331MPH](#)
[NEV1000M6.3DE](#) [NEV100M16CB](#) [NEV100M50DD-BULK](#) [NEV2200M16FF](#) [NEV220M50EE](#) [NEV2.2M50AA](#) [NEV330M63EF](#)
[NEV4700M35HI](#) [NEV4.7M100BA](#) [NEV47M16BA](#) [NEV47M50CB-BULK](#) [NEVH1.0M350AB](#) [NEVH2.2M160AB](#) [NEVH3.3M350BC](#)
[TER330M50GM](#) [477KXM035MGBWSA](#)