

# NPX

- ◆ 高可靠性 低ESR 高容许纹波电流
- ◆ 105℃ 2000小时保证
- ◆ RoHS指令 (2011/65/EU) 对应
- ◆ 小型化品



## ■ 主要技术参数

项目	特性	
工作温度范围	-55~+105℃	
额定工作电压	6.3~100V	
容量范围	2.2~10000µF 120Hz 20℃	
容量允许偏差	± 20% ( 120Hz20℃ )	
损耗角正切值	标准品一览表的价值以下 120Hz 20℃	
漏电流※	标准品一览表的价值以下 额定电压下充电2分钟, 20℃	
等效串联电阻 ( ESR )	标准品一览表的价值以下 100KHz 20℃	
耐久性	在105℃温度下, 施加额定工作电压2000小时, 并在20℃下放置16小时后, 产品应满足	
	静电容量变化率	初始值的 ± 20%
	等效串联电阻(ESR)	≤ 初始规格值的150%
	损失角正切值	≤ 初始规格值的150%
高温高湿	在60℃温度、90%~95%R.H湿度条件下放置1000小时, 不施加电压, 并在20℃下放置16小时后, 产品应满足	
	静电容量变化率	初始值的 ± 20%
	等效串联电阻(ESR)	≤ 初始规格值的150%
	漏电流	≤ 初始规格值

※当对漏电流值有疑义时, 请将产品置于105℃温度下施加额定工作电压2小时, 降温到20℃后再进行漏电流的测试。

## ■ 产品尺寸图 (单位: mm)

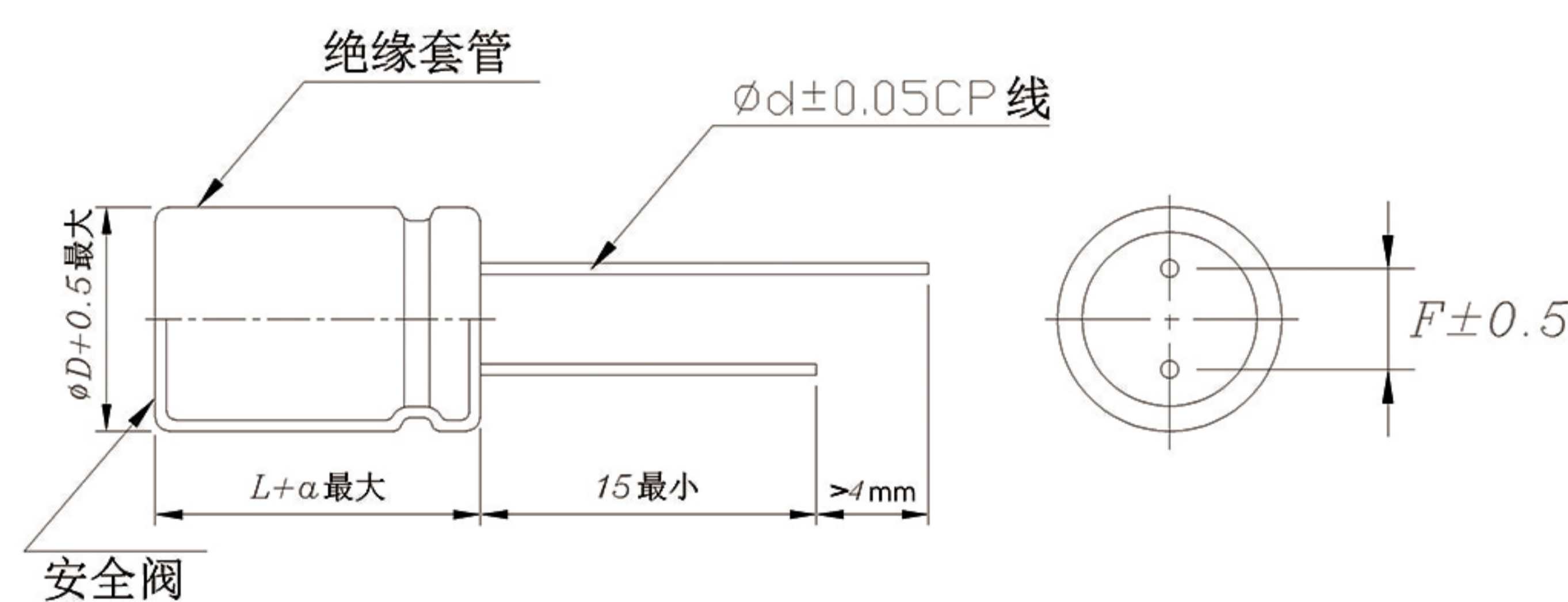

备注: ≥ φ 6.3产品有安全阀

D ( ± 0.5 )	5	5.5	6.3	8	10	12.5
d ( ± 0.05 )	0.45/0.50	0.45/0.50	0.45/0.50	0.6	0.6	0.6
F ( ± 0.5 )	2.0	2.5	2.5	3.5	5.0	5.0
α	+1					

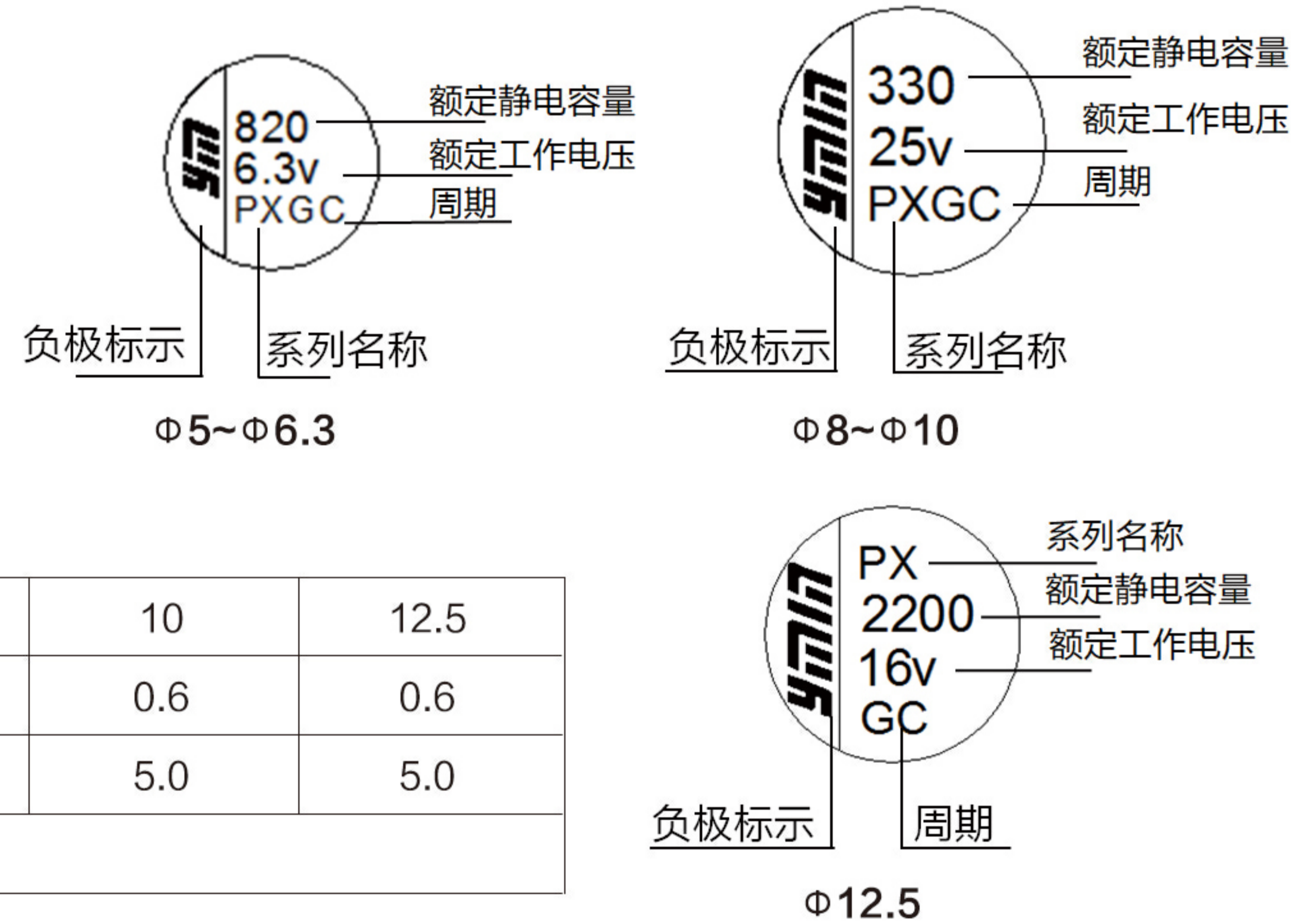

## ■ 频率修正因子

频率(Hz)	120Hz	1KHz	10KHz	100KHz	300KHz
修正因子	0.10	0.45	0.50	1.00	1.00

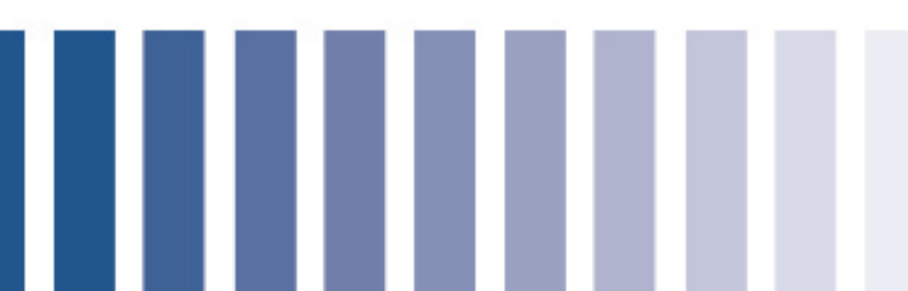

# NPX

## ■ 标准品一览表

额定电压 (浪涌电压) (V)	标称容量 ( $\mu$ F)	产品尺寸 $\Phi$ D×L(mm)	L.C. ( $\mu$ A,2min)	Tan $\delta$ 120Hz	ESR ( $m\Omega$ 100kHz)	额定纹波电流 (mA r.m.s/105°C100KHz)
6.3(7.2)	100	5×5.7	280	0.08	20	2400
6.3(7.2)	100	6.3×4.2	280	0.08	20	2500
6.3(7.2)	150	5×5.7	280	0.08	20	2400
6.3(7.2)	150	6.3×4.2	280	0.08	20	2500
6.3(7.2)	180	5×5.7	280	0.08	18	2600
6.3(7.2)	180	6.3×4.2	280	0.08	20	2500
6.3(7.2)	220	5×5.7	280	0.08	18	2600
6.3(7.2)	220	6.3×4.2	280	0.08	20	2500
6.3(7.2)	270	5×7	340	0.08	12	3400
6.3(7.2)	270	6.3×5.7	340	0.08	18	2800
6.3(7.2)	330	5×7	416	0.08	12	3400
6.3(7.2)	330	6.3×5.7	416	0.08	18	2800
6.3(7.2)	390	5×7	491	0.08	12	3400
6.3(7.2)	390	6.3×5.7	491	0.08	8	4800
6.3(7.2)	470	5×8	592	0.08	12	3650
6.3(7.2)	470	6.3×7	592	0.08	8	4800
6.3(7.2)	470	8×6	592	0.08	18	3000
6.3(7.2)	560	5.5×7	706	0.08	12	3800
6.3(7.2)	560	6.3×7	706	0.08	8	4800
6.3(7.2)	560	8×6	706	0.08	16	3450
6.3(7.2)	680	6.3×8	857	0.08	8	5000
6.3(7.2)	680	8×7	857	0.08	12	4200
6.3(7.2)	820	5.5×9	1033	0.08	8	4900
6.3(7.2)	820	6.3×7.5	1033	0.08	8	4900
6.3(7.2)	820	6.3×9	1033	0.08	8	5250
6.3(7.2)	820	8×7	1033	0.08	12	4200
6.3(7.2)	1000	6.3×10	1260	0.08	8	5500
6.3(7.2)	1000	8×8	1260	0.08	8	5600
6.3(7.2)	1000	10×7	1260	0.08	12	4500
6.3(7.2)	1200	6.3×11	1512	0.08	8	5700
6.3(7.2)	1200	8×9	1512	0.08	8	5800
6.3(7.2)	1200	10×8	1512	0.08	8	5800
6.3(7.2)	1500	8×11	1890	0.08	8	6150
6.3(7.2)	1500	10×9	1890	0.08	8	6050
6.3(7.2)	2000	8×14	2520	0.08	7	7250
6.3(7.2)	2000	10×10	2520	0.08	8	6300
6.3(7.2)	2200	8×14	2772	0.08	7	7500
6.3(7.2)	2200	10×10	2772	0.08	8	6300
6.3(7.2)	2500	10×11	3150	0.08	8	6500
6.3(7.2)	2700	10×11	3402	0.08	8	6500
6.3(7.2)	3300	10×12	4158	0.08	8	6640
6.3(7.2)	3900	10×14	4914	0.08	7	7600
6.3(7.2)	4700	10×16	5922	0.08	7	8100

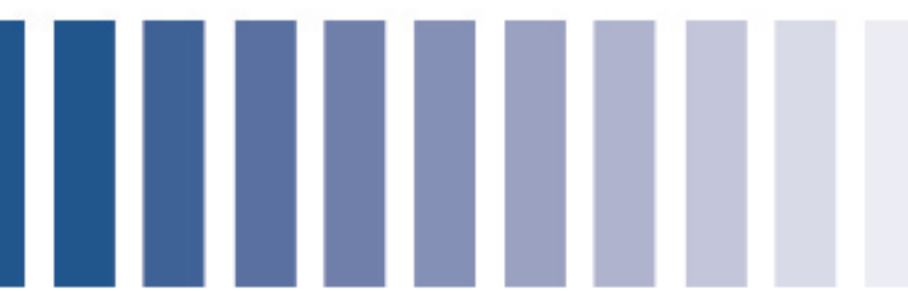

# NPX

## ■ 标准品一览表

额定电压 (浪涌电压) (V)	标称容量 ( $\mu$ F)	产品尺寸 $\Phi$ D×L(mm)	L.C. ( $\mu$ A,2min)	Tan $\delta$ 120Hz	ESR ( $m\Omega$ 100kHz)	额定纹波电流 (mA r.m.s/105°C100KHz)
6.3(7.2)	4700	12.5×12.5	5922	0.08	8	7600
6.3(7.2)	5600	10×18	7056	0.08	7	8500
6.3(7.2)	5600	12.5×14	7056	0.08	8	7900
6.3(7.2)	6800	10×21	7500	0.08	7	9100
6.3(7.2)	6800	12.5×16	7500	0.08	7	8950
6.3(7.2)	8200	12.5×18	7500	0.08	7	9450
6.3(7.2)	10000	12.5×20	7500	0.08	7	9850
7.5(8.6)	270	5×7	405	0.08	12	3400
7.5(8.6)	270	6.3×5.7	405	0.08	18	2800
7.5(8.6)	330	5×9	495	0.08	12	3800
7.5(8.6)	330	6.3×5.7	495	0.08	12	3700
7.5(8.6)	390	5×10	585	0.08	10	4350
7.5(8.6)	390	6.3×7	585	0.08	12	3900
7.5(8.6)	390	8×6	585	0.08	18	3250
7.5(8.6)	470	5.15×9	705	0.08	12	3850
7.5(8.6)	470	5×11	705	0.08	10	4500
7.5(8.6)	470	6.3×8	705	0.08	12	4100
7.5(8.6)	470	8×6	705	0.08	18	3000
7.5(8.6)	560	6.3×9	840	0.08	9	5000
7.5(8.6)	560	8×6	840	0.08	18	3250
7.5(8.6)	680	6.3×10	1020	0.08	8	5500
7.5(8.6)	680	8×7	1020	0.08	12	4200
7.5(8.6)	820	6.3×11	1230	0.08	8	5700
7.5(8.6)	820	8×8	1230	0.08	8	5600
7.5(8.6)	1000	6.3×11	1500	0.08	8	5900
7.5(8.6)	1000	8×9	1500	0.08	8	5800
10(11.5)	47	5×5.7	280	0.08	30	1900
10(11.5)	47	6.3×4.2	280	0.08	30	2100
10(11.5)	68	5×5.7	280	0.08	30	1900
10(11.5)	68	6.3×4.2	280	0.08	30	2100
10(11.5)	82	5×5.7	280	0.08	30	1900
10(11.5)	82	6.3×4.2	280	0.08	30	2100
10(11.5)	100	5×5.7	280	0.08	30	1900
10(11.5)	100	6.3×4.2	280	0.08	30	2100
10(11.5)	150	5×7	300	0.08	15	3050
10(11.5)	150	6.3×5.7	300	0.08	30	2200
10(11.5)	180	5×7	360	0.08	15	3050
10(11.5)	180	6.3×5.7	360	0.08	30	2200
10(11.5)	220	5×7	440	0.08	15	3050
10(11.5)	220	6.3×5.7	440	0.08	30	2200
10(11.5)	270	5×10	540	0.08	12	3950
10(11.5)	270	6.3×5.7	540	0.08	16	3200
10(11.5)	330	5×11	660	0.08	12	4100

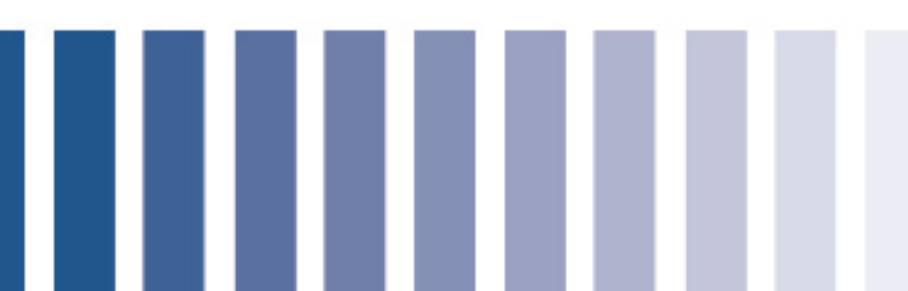

# NPX

## ■ 标准品一览表

额定电压 (浪涌电压) (V)	标称容量 ( $\mu$ F)	产品尺寸 $\Phi$ D×L(mm)	L.C. ( $\mu$ A,2min)	Tan $\delta$ 120Hz	ESR ( $m\Omega$ 100kHz)	额定纹波电流 (mA r.m.s/105°C100KHz)
10(11.5)	330	6.3×7	660	0.09	16	3200
10(11.5)	390	6.3×7	780	0.09	12	3900
10(11.5)	390	8×6	780	0.10	30	2550
10(11.5)	470	6.3×8	940	0.11	12	4300
10(11.5)	470	8×7	940	0.11	30	2550
10(11.5)	560	6.3×10	1120	0.13	10	4900
10(11.5)	560	8×7	1120	0.13	14	2550
10(11.5)	680	6.3×11	1360	0.15	9	5400
10(11.5)	680	8×8	1360	0.17	10	5100
10(11.5)	820	8×9	1640	0.20	9	5500
10(11.5)	820	10×7	1640	0.08	14	4500
10(11.5)	1000	8×11	2000	0.08	9	5800
10(11.5)	1000	10×8	2000	0.08	9	5500
10(11.5)	1500	8×14	3000	0.08	8	6800
10(11.5)	1500	10×12	3000	0.08	9	6300
10(11.5)	2200	10×14	4400	0.08	8	7000
10(11.5)	2500	10×14	5000	0.08	8	7000
10(11.5)	2700	10×16	5400	0.08	8	7500
10(11.5)	3300	10×18	6600	0.08	8	7900
10(11.5)	3300	12.5×14	6600	0.08	9	7500
10(11.5)	3900	10×21	7500	0.08	8	8400
10(11.5)	3900	12.5×16	7500	0.08	8	8400
10(11.5)	4700	12.5×18	7500	0.08	8	8400
10(11.5)	5600	12.5×18	7500	0.08	8	8800
10(11.5)	6800	12.5×20	7500	0.08	8	9200
12(13.8)	180	5×7	432	0.08	15	3050
12(13.8)	180	6.3×5.7	432	0.08	30	2200
12(13.8)	220	5×9	528	0.08	15	3400
12(13.8)	220	6.3×5.7	528	0.08	16	3200
12(13.8)	270	5×10	648	0.08	12	3950
12(13.8)	270	6.3×7	648	0.08	16	3200
12(13.8)	330	5×10	792	0.08	12	3950
12(13.8)	330	6.3×7	792	0.08	12	3900
12(13.8)	330	8×6	792	0.08	30	2550
12(13.8)	390	5.5×9	936	0.08	15	3450
12(13.8)	390	5×11	936	0.08	12	4100
12(13.8)	390	6.3×8	936	0.08	12	4100
12(13.8)	470	6.3×9	1128	0.08	12	4300
12(13.8)	470	8×7	1128	0.08	14	2550
12(13.8)	560	6.3×10	1344	0.08	10	4900
12(13.8)	560	8×7	1344	0.08	14	2550
12(13.8)	680	6.3×11	1632	0.08	9	5400
12(13.8)	680	8×8	1632	0.08	10	5100

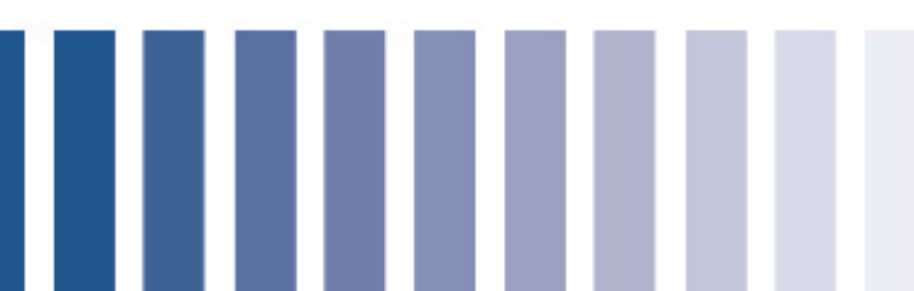

# NPX

## ■ 标准品一览表

额定电压 (浪涌电压) (V)	标称容量 ( $\mu$ F)	产品尺寸 $\Phi$ D×L(mm)	L.C. ( $\mu$ A,2min)	Tan $\delta$ 120Hz	ESR ( $m\Omega$ 100kHz)	额定纹波电流 (mA r.m.s/105°C100KHz)
12(13.8)	1000	8×9	2400	0.08	10	5200
16(18.4)	22	5×5.7	280	0.08	30	1900
16(18.4)	22	6.3×4.2	280	0.08	30	2100
16(18.4)	33	5×5.7	280	0.08	30	1900
16(18.4)	33	6.3×4.2	280	0.08	30	2100
16(18.4)	47	5×5.7	280	0.08	30	1900
16(18.4)	47	6.3×4.2	280	0.08	30	2100
16(18.4)	68	5×5.7	280	0.08	30	1900
16(18.4)	68	6.3×4.2	280	0.08	30	2100
16(18.4)	82	5.15×5.7	280	0.08	30	1900
16(18.4)	82	6.3×4.2	280	0.08	30	2100
16(18.4)	100	5×5.7	320	0.08	30	2000
16(18.4)	100	5×7	320	0.08	30	2200
16(18.4)	100	6.3×5.7	320	0.08	30	2100
16(18.4)	150	5×7	480	0.08	30	2200
16(18.4)	150	6.3×5.7	480	0.08	30	2200
16(18.4)	220	5×9	704	0.08	12	3950
16(18.4)	220	5×10	704	0.08	12	3950
16(18.4)	220	6.3×5.7	704	0.08	20	2850
16(18.4)	220	6.3×5.7	704	0.08	20	2850
16(18.4)	270	6.3×7	864	0.08	15	3500
16(18.4)	270	8×6	864	0.08	30	2550
16(18.4)	330	6.3×8	1056	0.08	12	4300
16(18.4)	330	8×6	1056	0.08	30	2550
16(18.4)	390	6.3×8	1248	0.08	12	4300
16(18.4)	470	5.5×10	1504	0.08	12	4200
16(18.4)	470	6.3×10	1504	0.08	10	4900
16(18.4)	470	8×7	1504	0.08	20	3300
16(18.4)	560	6.3×10	1792	0.08	10	4900
16(18.4)	560	8×9	1792	0.08	12	4700
16(18.4)	560	10×8	1792	0.08	12	4700
16(18.4)	680	6.3×11	2176	0.08	10	5350
16(18.4)	680	8×10	2176	0.08	10	5350
16(18.4)	680	10×8	2176	0.08	12	4700
16(18.4)	820	8×11	2624	0.08	10	5500
16(18.4)	820	10×9	2624	0.08	12	4950
16(18.4)	1000	8×11	3200	0.08	10	5800
16(18.4)	1000	8×14	3200	0.08	8	6800
16(18.4)	1000	10×10	3200	0.08	12	5200
16(18.4)	1500	8×14	3200	0.08	12	8400
16(18.4)	1500	10×12	4800	0.08	8	8400
16(18.4)	1800	10×13	5760	0.08	8	7000
16(18.4)	2200	10×15	7040	0.08	8	7500

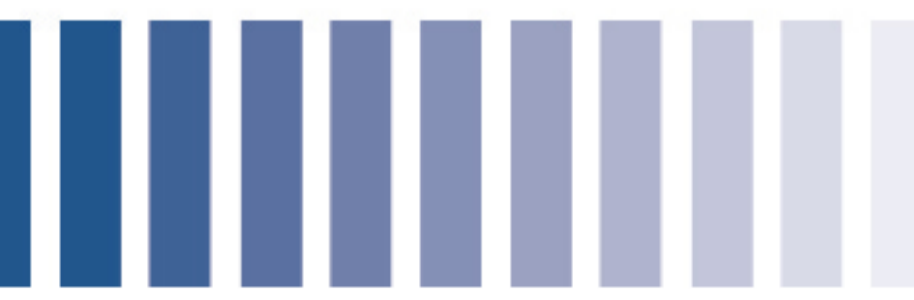

# NPX

## ■ 标准品一览表

额定电压 (浪涌电压) (V)	标称容量 ( $\mu$ F)	产品尺寸 $\Phi$ D×L(mm)	L.C. ( $\mu$ A,2min)	Tan $\delta$ 120Hz	ESR ( $m\Omega$ 100kHz)	额定纹波电流 (mA r.m.s/105°C100KHz)
16(18.4)	2200	10×18	7040	0.08	8	7900
16(18.4)	2200	12.5×14	7040	0.08	10	7100
16(18.4)	2700	10×16	7500	0.08	8	7800
16(18.4)	2700	10×21	7500	0.08	8	8400
16(18.4)	2700	12.5×14	7500	0.08	10	7100
16(18.4)	3300	10×18	7500	0.08	8	8400
16(18.4)	3300	12.5×16	7500	0.08	8	8400
16(18.4)	3900	12.5×18	7500	0.08	8	8800
16(18.4)	4700	12.5×20	7500	0.08	8	9200
25(28.8)	10	5×5.7	280	0.08	40	1650
25(28.8)	10	6.3×4.2	280	0.08	40	1800
25(28.8)	15	5×5.7	280	0.08	40	1650
25(28.8)	15	6.3×4.2	280	0.08	40	1800
25(28.8)	22	5×5.7	280	0.08	40	1650
25(28.8)	22	6.3×4.2	280	0.08	40	1800
25(28.8)	33	5×5.7	280	0.08	40	1650
25(28.8)	33	6.3×4.2	280	0.08	40	1800
25(28.8)	39	5×5.7	280	0.08	40	1650
25(28.8)	39	6.3×4.2	280	0.08	40	1800
25(28.8)	47	5×5.7	280	0.08	30	2050
25(28.8)	47	6.3×4.2	280	0.08	40	1800
25(28.8)	68	5×7	340	0.08	30	2200
25(28.8)	68	6.3×5.7	340	0.08	40	1900
25(28.8)	100	5×9	500	0.08	30	2400
25(28.8)	100	6.3×5.7	500	0.08	30	2350
25(28.8)	150	6.3×8	750	0.08	16	3550
25(28.8)	150	8×6	750	0.08	30	2550
25(28.8)	180	6.3×8	900	0.08	16	3550
25(28.8)	180	8×7	900	0.08	30	2550
25(28.8)	220	6.3×9	1100	0.08	20	3500
25(28.8)	220	8×7	1100	0.08	30	2700
25(28.8)	220	10×6	1100	0.08	30	2700
25(28.8)	330	8×9	1650	0.08	16	4000
25(28.8)	330	10×8	1650	0.08	16	4100
25(28.8)	470	8×11	2350	0.08	16	4200
25(28.8)	470	8×14	2350	0.08	16	4800
25(28.8)	470	10×9	2350	0.08	16	4300
25(28.8)	560	8×11	2800	0.08	16	4400
25(28.8)	560	8×14	2800	0.08	16	4800
25(28.8)	560	10×10	2800	0.08	16	4500
25(28.8)	680	8×14	3400	0.08	16	4800
25(28.8)	680	10×12	3400	0.08	16	4700
25(28.8)	820	8×16	4100	0.08	16	5050

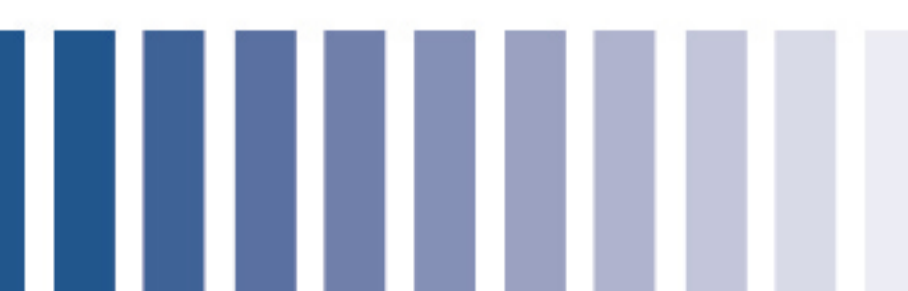

# NPX

## ■ 标准品一览表

额定电压 (浪涌电压) (V)	标称容量 ( $\mu$ F)	产品尺寸 $\Phi$ D×L(mm)	L.C. ( $\mu$ A,2min)	Tan $\delta$ 120Hz	ESR ( $m\Omega$ 100kHz)	额定纹波电流 (mA r.m.s/105°C100KHz)
25(28.8)	820	8×14	4100	0.08	16	4900
25(28.8)	820	10×13	4100	0.08	16	4800
25(28.8)	1000	10×16	5000	0.08	16	5300
25(28.8)	1000	12.5×12.5	5000	0.08	16	5300
25(28.8)	1500	10×18	7500	0.08	16	5600
25(28.8)	1500	12.5×14	7500	0.08	16	5600
25(28.8)	1800	10×21	7500	0.08	16	6000
25(28.8)	1800	12.5×16	7500	0.08	16	5900
25(28.8)	2200	12.5×18	7500	0.08	16	6200
25(28.8)	2700	12.5×20	7500	0.08	16	6500
35(41)	10	5×5.7	300	0.12	60	1350
35(41)	10	6.3×4.2	300	0.12	60	1400
35(41)	15	5×5.7	300	0.12	60	1350
35(41)	15	6.3×4.2	300	0.12	60	1400
35(41)	22	5×5.7	300	0.12	60	1450
35(41)	22	6.3×4.2	300	0.12	60	1400
35(41)	33	5×5.7	300	0.12	60	1450
35(41)	33	6.3×4.2	300	0.12	60	1400
35(41)	39	5×7	300	0.12	50	1700
35(41)	39	6.3×5.7	300	0.12	60	1550
35(41)	47	5×7	329	0.12	50	1700
35(41)	47	6.3×5.7	329	0.12	60	1550
35(41)	56	5×7	392	0.12	50	1700
35(41)	56	6.3×5.7	392	0.12	60	1650
35(41)	68	5×8	476	0.12	50	1800
35(41)	68	6.3×5.7	476	0.12	60	1650
35(41)	68	8×6	476	0.12	60	1650
35(41)	82	5×9	574	0.12	50	1900
35(41)	82	6.3×7	574	0.12	50	1900
35(41)	100	6.3×7	700	0.12	50	1900
35(41)	100	8×6	700	0.12	60	1800
35(41)	120	6.3×8	840	0.12	50	2050
35(41)	120	8×7	840	0.12	60	1900
35(41)	150	6.3×9	1050	0.12	50	2150
35(41)	150	8×7	1050	0.12	60	1900
35(41)	180	6.3×10	1260	0.12	40	2500
35(41)	180	8×7	1260	0.12	60	1900
35(41)	220	6.3×11	1540	0.12	40	2600
35(41)	220	8×8	1540	0.12	50	2200
35(41)	220	10×7	1540	0.12	60	2050
35(41)	330	8×10	2310	0.12	30	3100
35(41)	330	10×8	2310	0.12	50	2350
35(41)	390	8×11	2730	0.12	30	3200

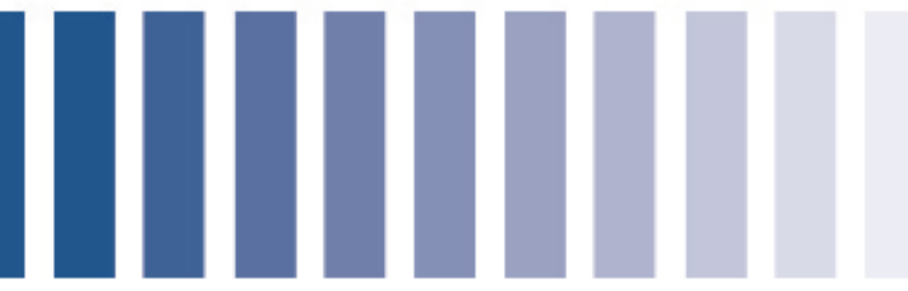

# NPX

## ■ 标准品一览表

额定电压 (浪涌电压) (V)	标称容量 ( $\mu$ F)	产品尺寸 $\Phi$ D×L(mm)	L.C. ( $\mu$ A,2min)	Tan $\delta$ 120Hz	ESR ( $m\Omega$ 100kHz)	额定纹波电流 (mA r.m.s/105°C100KHz)
35(41)	390	10×10	2730	0.12	50	2550
35(41)	470	8×14	3290	0.12	20	4250
35(41)	470	10×11	3290	0.12	30	3400
35(41)	560	8×16	3920	0.12	20	4550
35(41)	560	10×12	3920	0.12	30	3450
35(41)	680	10×14	4760	0.12	20	4450
35(41)	820	10×16	5000	0.12	20	4700
35(41)	820	12.5×12.5	5000	0.12	30	3900
35(41)	1000	10×18	5000	0.12	20	5000
35(41)	1000	12.5×14	5000	0.12	30	4100
35(41)	1200	10×21	5000	0.12	20	5300
35(41)	1200	12.5×16	5000	0.12	20	5300
35(41)	1500	12.5×18	5000	0.12	20	5600
35(41)	1800	12.5×20	5000	0.12	20	5850
50(58)	10	5×5.7	300	0.12	60	1350
50(58)	10	6.3×4.2	300	0.12	60	1400
50(58)	12	5×5.7	300	0.12	60	1350
50(58)	12	6.3×4.2	300	0.12	60	1400
50(58)	15	5×5.7	300	0.12	60	1450
50(58)	15	6.3×4.2	300	0.12	60	1400
50(58)	18	5×5.7	300	0.12	60	1450
50(58)	18	6.3×4.2	300	0.12	60	1400
50(58)	22	5×7	300	0.12	60	1450
50(58)	22	6.3×5.7	300	0.12	60	1550
50(58)	33	5×8	330	0.12	50	1800
50(58)	33	6.3×5.7	330	0.12	60	1650
50(58)	39	5×10	390	0.12	40	2200
50(58)	39	6.3×7	390	0.12	60	1650
50(58)	47	6.3×7	470	0.12	50	1900
50(58)	47	8×6	470	0.12	60	1650
50(58)	56	6.3×8	560	0.12	50	1900
50(58)	56	8×7	560	0.12	60	1800
50(58)	68	6.3×9	680	0.12	50	2150
50(58)	68	8×7	680	0.12	60	1800
50(58)	82	6.3×10	820	0.12	40	2500
50(58)	82	8×7	820	0.12	60	1900
50(58)	100	8×8	1000	0.12	50	2200
50(58)	100	10×6.5	1000	0.12	60	2000
50(58)	120	8×9	1200	0.12	50	2300
50(58)	120	10×7	1200	0.12	60	2050
50(58)	150	8×9	1500	0.12	50	2300
50(58)	150	10×8	1500	0.12	50	2350
50(58)	180	8×11	1800	0.12	40	2800



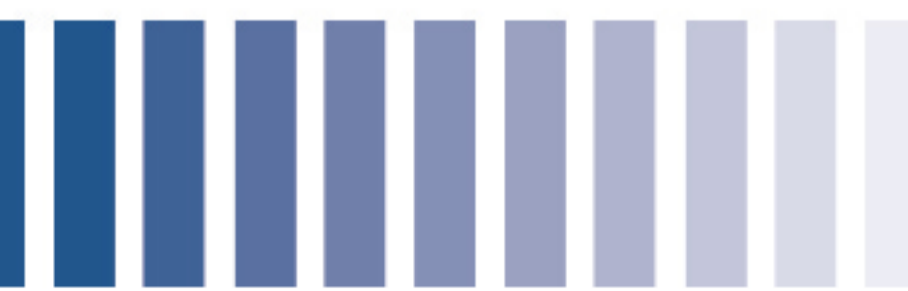

# NPX

## ■ 标准品一览表

额定电压 (浪涌电压) (V)	标称容量 ( $\mu$ F)	产品尺寸 $\Phi$ D×L(mm)	L.C. ( $\mu$ A,2min)	Tan $\delta$ 120Hz	ESR ( $m\Omega$ 100kHz)	额定纹波电流 (mA r.m.s/105°C100KHz)
50(58)	180	10×9	1800	0.12	50	2450
50(58)	220	8×14	2200	0.12	30	3500
50(58)	220	10×9	2200	0.12	50	2450
50(58)	220	10×11	2200	0.12	40	2900
50(58)	270	8×16	2700	0.12	30	3700
50(58)	270	10×13	2700	0.12	40	3000
50(58)	330	10×16	3300	0.12	30	3800
50(58)	390	10×16	3900	0.12	30	3800
50(58)	390	12.5×12.5	3900	0.12	40	3350
50(58)	470	10×18	4700	0.12	30	4050
50(58)	470	12.5×14	4700	0.12	40	3500
50(58)	560	10×21	5000	0.12	30	4350
50(58)	560	12.5×16	5000	0.12	30	4300
50(58)	680	12.5×18	5000	0.12	30	4550
50(58)	820	12.5×20	5000	0.12	30	4750
63(73)	6.8	5×5.7	300	0.12	60	1350
63(73)	6.8	6.3×4.2	300	0.12	60	1400
63(73)	8.2	5×5.7	300	0.12	60	1450
63(73)	8.2	6.3×4.2	300	0.12	60	1400
63(73)	10	5×5.7	300	0.12	60	1450
63(73)	10	6.3×4.2	300	0.12	60	1400
63(73)	15	5×7	300	0.12	60	1450
63(73)	15	6.3×4.2	300	0.12	60	1400
63(73)	22	5×9	300	0.12	50	1900
63(73)	22	6.3×7	300	0.12	50	1900
63(73)	33	6.3×7	416	0.12	50	1900
63(73)	33	8×7	416	0.12	60	1800
63(73)	39	6.3×9	491	0.12	50	2150
63(73)	39	8×7	491	0.12	60	1800
63(73)	47	6.3×10	592	0.12	40	2500
63(73)	47	8×7	592	0.12	60	1900
63(73)	56	8×8	706	0.12	50	2200
63(73)	56	10×6	706	0.12	60	1950
63(73)	68	8×9	857	0.12	50	2300
63(73)	68	10×7	857	0.12	60	2050
63(73)	82	8×9	1033	0.12	50	2300
63(73)	82	10×7	1033	0.12	60	2050
63(73)	100	8×10	1260	0.12	40	2700
63(73)	100	10×8	1260	0.12	50	2350
63(73)	120	8×13	1512	0.12	40	3000
63(73)	120	10×9	1512	0.12	50	2450
63(73)	150	8×16	1890	0.12	30	3700
63(73)	150	10×13	1890	0.12	40	3000

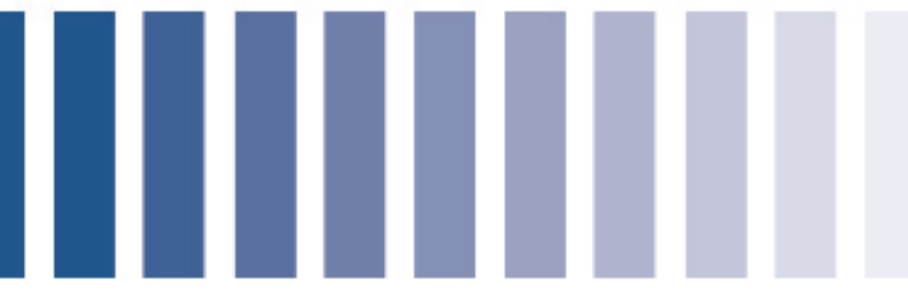

# NPX

## ■ 标准品一览表

额定电压 (浪涌电压) (V)	标称容量 ( $\mu$ F)	产品尺寸 $\Phi$ D×L(mm)	L.C. ( $\mu$ A,2min)	Tan $\delta$ 120Hz	ESR ( $m\Omega$ 100kHz)	额定纹波电流 (mA r.m.s/105°C100KHz)
63(73)	180	10×14	2268	0.12	30	3600
63(73)	220	10×16	2772	0.12	30	3800
63(73)	220	12.5×12.5	2772	0.12	40	3350
63(73)	270	10×18	3402	0.12	30	4050
63(73)	270	12.5×14	3402	0.12	40	3500
63(73)	330	10×21	4158	0.12	30	4350
63(73)	330	12.5×16	4158	0.12	30	4300
63(73)	390	12.5×18	4914	0.12	30	4550
63(73)	470	12.5×20	5000	0.12	30	4750
80(92)	4.7	5×5.7	300	0.12	60	1350
80(92)	4.7	6.3×4.2	300	0.12	60	1400
80(92)	6.8	5×5.7	300	0.12	60	1450
80(92)	6.8	6.3×4.2	300	0.12	60	1400
80(92)	8.2	5×5.7	300	0.12	60	1450
80(92)	8.2	6.3×4.2	300	0.12	60	1400
80(92)	10	5×7	300	0.12	60	1450
80(92)	10	6.3×4.2	300	0.12	60	1400
80(92)	15	5×9	300	0.12	50	1900
80(92)	15	6.3×7	300	0.12	50	1900
80(92)	22	6.3×7	352	0.12	50	1900
80(92)	22	8×7	352	0.12	60	1800
80(92)	33	6.3×10	528	0.12	40	2500
80(92)	33	8×7	528	0.12	60	1800
80(92)	39	6.3×11	624	0.12	40	2600
80(92)	39	8×8	624	0.12	50	2200
80(92)	47	8×8	752	0.12	50	2200
80(92)	47	10×7	752	0.12	60	2050
80(92)	56	8×9	896	0.12	50	2300
80(92)	56	10×9	896	0.12	50	2450
80(92)	68	8×10	1088	0.12	40	2700
80(92)	68	10×9	1088	0.12	50	2450
80(92)	82	8×12	1312	0.12	40	2900
80(92)	82	10×10	1312	0.12	50	2550
80(92)	100	8×14	1600	0.12	30	3500
80(92)	100	10×12	1600	0.12	40	2950
80(92)	120	8×16	1920	0.12	30	3700
80(92)	120	10×13	1920	0.12	40	3000
80(92)	150	10×16	2400	0.12	30	3800
80(92)	150	12.5×12.5	2400	0.12	40	3350
80(92)	180	10×18	2880	0.12	30	4050
80(92)	180	12.5×14	2880	0.12	40	3500
80(92)	220	10×21	3520	0.12	30	4350
80(92)	220	12.5×16	3520	0.12	30	4300

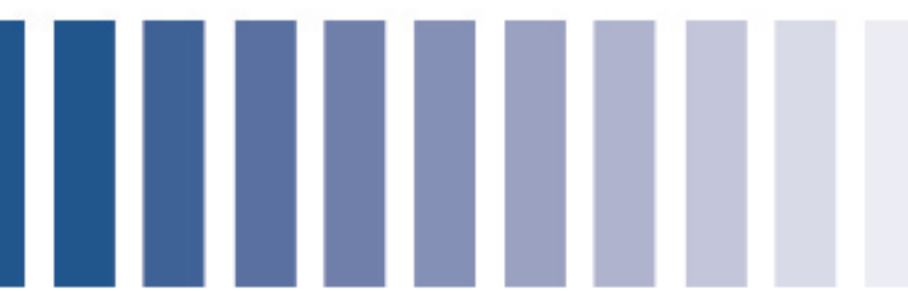

# NPX

## ■ 标准品一览表

额定电压 (浪涌电压) (V)	标称容量 ( $\mu$ F)	产品尺寸 $\Phi$ D×L(mm)	L.C. ( $\mu$ A,2min)	Tan $\delta$ 120Hz	ESR ( $m\Omega$ 100kHz)	额定纹波电流 (mA r.m.s/105°C100KHz)
80(92)	270	12.5×18	4320	0.12	30	4550
80(92)	330	12.5×20	5000	0.12	30	4750
100(115)	2.2	5×5.7	300	0.12	80	1200
100(115)	2.2	6.3×4.2	300	0.12	80	1250
100(115)	3.3	5×5.7	300	0.12	60	1450
100(115)	3.3	6.3×4.2	300	0.12	80	1250
100(115)	4.7	5×7	300	0.12	60	1450
100(115)	4.7	6.3×5.7	300	0.12	80	1350
100(115)	5.6	5×7	300	0.12	60	1450
100(115)	5.6	6.3×5.7	300	0.12	80	1350
100(115)	6.8	5×8	300	0.12	60	1550
100(115)	6.8	6.3×5.7	300	0.12	60	1650
100(115)	8.2	5×9	300	0.12	60	1700
100(115)	8.2	6.3×7	300	0.12	60	1650
100(115)	10	6.3×7	300	0.12	60	1650
100(115)	12	6.3×8	300	0.12	50	1900
100(115)	15	6.3×9	300	0.12	50	2150
100(115)	15	8×7	300	0.12	60	1800
100(115)	18	6.3×10	360	0.12	50	2250
100(115)	18	8×7	360	0.12	60	1900
100(115)	22	6.3×11	440	0.12	50	2300
100(115)	22	8×8	440	0.12	50	2200
100(115)	27	8×8	540	0.12	50	2200
100(115)	27	10×7	540	0.12	60	2050
100(115)	33	8×9	660	0.12	50	2300
100(115)	33	10×9	660	0.12	50	2450
100(115)	39	8×10	780	0.12	50	2400
100(115)	39	10×9	780	0.12	50	2450
100(115)	47	8×12	940	0.12	50	2600
100(115)	47	10×10	940	0.12	50	2550
100(115)	56	8×14	1120	0.12	40	3050
100(115)	56	10×12	1120	0.12	50	2650
100(115)	68	8×16	1360	0.12	40	3200
100(115)	68	10×13	1360	0.12	50	2700
100(115)	82	10×14	1640	0.12	40	3100
100(115)	82	12.5×12.5	1640	0.12	50	3000
100(115)	100	10×18	2000	0.12	40	3500
100(115)	100	12.5×14	2000	0.12	50	3150
100(115)	120	10×21	2400	0.12	40	3750
100(115)	120	12.5×16	2400	0.12	40	3700
100(115)	150	12.5×18	3000	0.12	40	3900
100(115)	180	12.5×20	3600	0.12	40	4100

## X-ON Electronics

Largest Supplier of Electrical and Electronic Components

*Click to view similar products for [Aluminium Electrolytic Capacitors - Radial Leaded](#) category:*

*Click to view products by [Ymin](#) manufacturer:*

Other Similar products are found below :

[LXY50VB4.7M-5X11](#) [RFO-100V471MJ7P#](#) [ECE-A1EGE220](#) [B41041A2687M8](#) [B41041A7226M8](#) [B41044A7157M6](#)  
[EKXG201EC3101ML20S](#) [EKZM160ETD471MHB5D](#) [NCD681K10KVY5PF](#) [NEV1000M25EF-BULK](#) [NEV100M35DC](#) [NEV100M63DE](#)  
[NEV220M25DD-BULK](#) [NEV.33M100AA](#) [NEV4700M50HB](#) [NEV.47M100AA](#) [NEVH1.0M250AB](#) [NEVH3.3M250BB](#) [NEVH3.3M450CC](#)  
[KM4700/16](#) [KME50VB100M-8X11.5](#) [SG220M1CSA-0407](#) [ES5107M016AE1DA](#) [ESMG160ETD102MJ16S](#) [ESX472M16B](#) [227RZS050M](#)  
[476CKH100MSA](#) [477RZS050M](#) [UVX1V101KPA1FA](#) [UVX1V222MHA1CA](#) [KME25VB100M-6.3X11](#) [VTL100S10](#) [VTL470S10](#)  
[VTL470S16A](#) [511D336M250EK5D](#) [052687X](#) [ECE-A1CF471](#) [EKMA500ELL4R7ME07D](#) [NRE-S560M16V6.3X7TBSTF](#) [RGA221M1CTA-](#)  
[0611G](#) [ERZA630VHN182UP54N](#) [UPL1A331MPH](#) [SK035M0100AZS-0611](#) [MAL214658821E3](#) [NEV1000M6.3DE](#) [NEV100M16CB](#)  
[NEV100M50DD-BULK](#) [NEV2200M16FF](#) [NEV220M50EE](#) [NEV2.2M50AA](#)