

上海永铭电子股份有限公司 Shanghai Yongming Electronic Co.,Ltd	铝电解电容器承认书 Aluminum Electrolytic Capacitors Specification	
--	--	---

版本 Version	日期 Date	标志 Mark	页码 Page	内容 Content	目的 Aim	设计 Design	审核 Checked

名称 Name	承认书 Specification		
版本 Version	03	页数 Page	2
标准指南 Standard manual			

客户名 Customer	天河星	系列 SERIES	VKL(T)
--------------	-----	-----------	--------

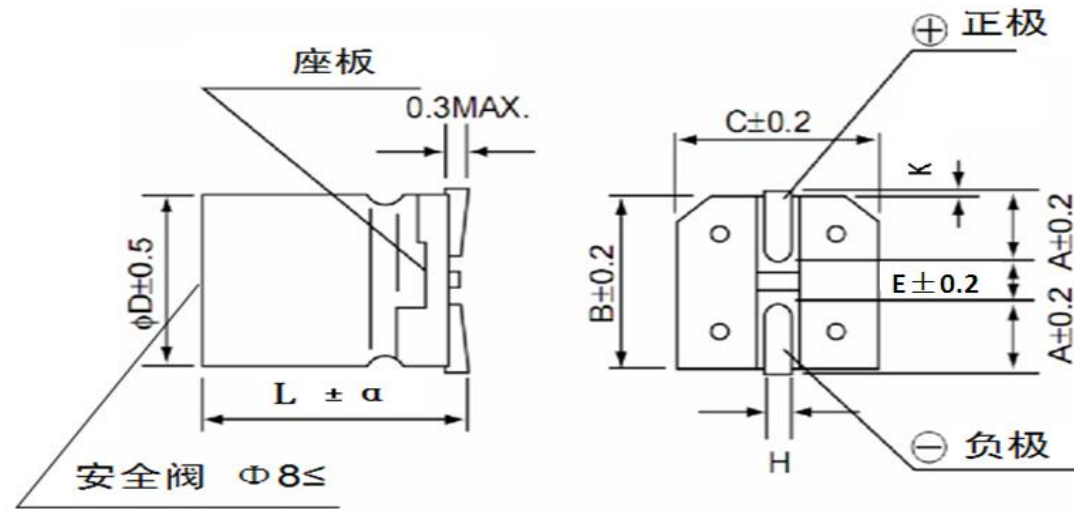

FIG-1

注: 表 2: 尺寸 Dimensions

表 3: 纹波电流频率修正系数 Ripple Current Frequency Correction Factor

表 1 TABLE-1

No	客户物料 编码 Customer Part No	永铭物 料编码 Ymin Part No	额定 电压 Rated Voltage (V.DC)	容量 Capacitance (μF)	浪涌 电压 Surge Voltage (V.DC)	使用温度 范围 Operating Temp.Range ($^{\circ}C$)	容量范围 Tolerance On Rated Capacitance (%) 25 \pm 2 $^{\circ}C$ 120Hz	损耗 Tan δ (Max) (%) 25 \pm 2 $^{\circ}C$ 120Hz	阻抗 Impedance (Ω) Max at 25 \pm 2 $^{\circ}C$ 100KHz	最大纹波电流 (125 $^{\circ}C$ 100KHz) Max Ripple Current(mA) At125 $^{\circ}C$ 100KHz	漏电流 Leakage Current (μA) (2min 充电时间)	寿命 Endurance At125 $^{\circ}C$ (HOURS)	尺寸 Dimensions(mm)			外观 Appearance Drawing No.
													ϕD	L	α	
1		VKL(T)E1001V221MVTMCG	35	220	44	-40~+125	$\pm 20\%$	16	0.20	550	77.0	3000	10	10	± 0.5	FIG-1
2																
3																
4																
5																
6																

上海永铭电子股份有限公司 Shanghai Yongming Electronic Co.,Ltd	铝电解电容器承认书 Aluminum Electrolytic Capacitors Specification	
--	--	---

表 2: 详细尺寸数据表 Dimensions:

ΦD	L	B	C	A	H	E	K	α
5	10	5.3	5.3	2.1	0.75±0.10	1.3	0.7MAX	±0.5
5	12	5.3	5.3	2.1	0.75±0.10	1.3	0.7MAX	±0.5
6.3	10	6.6	6.6	2.6	0.75±0.10	1.8	0.7MAX	±0.5
6.3	12	6.6	6.6	2.6	0.75±0.10	1.8	0.7MAX	±0.5
8	10	8.3	8.3	3.4	0.90±0.20	3.1	0.7MAX	±0.5
8	12.5	8.3	8.3	3.4	0.90±0.20	3.1	0.7MAX	±0.5
8	14.5	8.3	8.3	3.4	0.90±0.20	3.1	0.7MAX	±0.5
8	16.5	8.3	8.3	3.4	0.90±0.20	3.1	0.7MAX	±0.5
8	20.5	8.3	8.3	3.4	0.90±0.20	3.1	0.7MAX	±0.5
10	10	10.3	10.3	3.5	0.90±0.20	4.6	0.7MAX	±0.5
10	13	10.3	10.3	3.5	0.90±0.20	4.6	0.7MAX	±0.5
10	14.5	10.3	10.3	3.5	0.90±0.20	4.6	0.7MAX	±0.5
10	16.5	10.3	10.3	3.5	0.90±0.20	4.6	0.7MAX	±0.5
10	21	10.3	10.3	3.5	0.90±0.20	4.6	0.7MAX	±0.5
12.5	13.5	13.0	13.0	4.7	0.90±0.30	4.4	0.7MAX	±1.0
12.5	14.5	13.0	13.0	4.7	0.90±0.30	4.4	0.7MAX	±1.0
12.5	16.5	13.0	13.0	4.7	0.90±0.30	4.4	0.7MAX	±1.0
12.5	21	13.0	13.0	4.7	0.90±0.30	4.4	0.7MAX	±1.0
16	16.5	17.0	17.0	5.5	1.20±0.30	6.7	0.7±0.30	±1.0
16	21	17.0	17.0	5.5	1.20±0.30	6.7	0.7±0.30	±1.0
18	16.5	19.0	19.0	6.7	1.20±0.30	6.7	0.7±0.30	±1.0
18	21	19.0	19.0	6.7	1.20±0.30	6.7	0.7±0.30	±1.0
20	16.5	21.1	21.1	6.2	1.30±0.30	8.8	0.7±0.30	±1.0
20	21.5	21.1	21.1	6.2	1.30±0.30	8.8	0.7±0.30	±1.0

表 3: 纹波电流频率修正因子 Ripple Current Frequency Correction Factor

频率 Frequency (Hz)		120	1K	10K	100K≤
修正因子 Correction factor	0.47~8.2	0.42	0.60	0.80	1.00
	10~39	0.45	0.75	0.90	1.00
	47~180	0.50	0.80	0.95	1.00
	≥220	0.60	0.85	0.95	1.00

名称	Name	承认书			Specification
版本	Version	03	页数	Page	4
标准指南 Standard manual					

上海永铭电子股份有限公司 Shanghai Yongming Electronic Co.,Ltd	铝电解电容器承认书 Aluminum Electrolytic Capacitors Specification	
--	--	---

1 概述 SCOPE

本承认书规定了贴片式引线引出铝电解电容器的技术规范。

This specification covers miniature SMD Aluminum Electrolytic Capacitors.

2 参考标准 APPLICABLE SPECIFICATION

本承认书参考 JISC-5141 和 JISC-5102 制定。

This approval sheet consulted the institute of JISC-5141 and JISC-5102.

3 工作温度范围 OPERATING TEMPERATURE RANGE

工作温度范围是电容器在施加额定工作电压和额定纹波电流的条件下，可以长期可靠工作的环境温度范围。

-25~+125 °C (160~450V.DC) -40~+125 °C (≤100V.DC)

Operating temperature range is the range of ambient temperature at which the capacitors can be operated continuously at rated voltage.

-25~+125 °C (160~450V.DC) -40~+125 °C (≤100V.DC)

4 测试环境 CHARACTERISTICS

如果没有其他规定，标准的测试、检验环境条件如下所示：

环境温度：15~35°C

相对湿度：60~70%

大气压力：86kpa~106kpa

如果对测试结果有异议，可以在以下条件测试：环境温度

度：20°C±1°C

相对湿度：60%~70%

大气压力：86kpa~106kpa

Unless otherwise specified, the standard range of atmospheric conditions for making measurements and tests are as follows.

Ambient temperature : 15 to 35°C

Relative humidity : 60 to 70%

Air pressure : 86kpa to 106kpa

If there may be doubt on the results, measurements shall be made within the following limits

Ambient temperature : 20±1°C

Relative humidity : 60% to 67%

Air pressure : 86kpa to 106kpa

5. 产品特性 PRODUCT CHARACTERISTICS

5.1 电气特性 ELECTRICAL CHARACTERISTICS

序号 NO	项目 Item	测试方法 Test method	性能 Performance
5.1.1	额定工作电压 Rated voltage		10~450 V.DC

名称 Name	承认书 Specification		
版本 Version	03	页数 Page	5
标准指南 Standard manual			

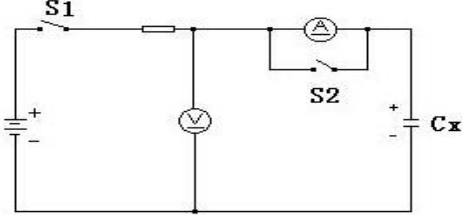
5.1.2	电容量 Capacitance	测试频率: 120Hz±20% 测试电路: 串联等效电路 测试电压: 0.3Vrms Measuring frequency: 120Hz±20% Measuring circuit: Series equivalent circuit Measuring voltage: 0.3Vrms	标称容量 0.47~10000uF -20%~+20% Range of Capacitance: 容量偏差: -20%~+20% Capacitance tolerance: -20%~+20%
5.1.3	损失角正切值 Dissipation Factor	测试条件与 5.1.2 电容量测试相同 Testing condition are the same as 5.1.2 for capacitance	见表 1 see table 1
5.1.4	漏电流 Leakage current	在电容器两端施加额定工作电压, 并串联 1000±100 Ω 电阻, 在施加电压 2 分钟后, 测量漏电流。 测试电路如下图: The rated voltage shall be applied across the capacitors and its protective resistor which shall be 1000±100 Ω. The leakage current shall then be measured after an electrification period of 2 min.. Measurement circuit  Rs: 保护电阻 (1000±100 Ω) Protective resistor(1000±100 Ω) ⊖: 直流电压表 ⊖: DC voltmeter ⊕: 直流电流表 ⊕: DC ammete S ₁ : 开关 S ₁ :Switch S ₂ : 电流表保护开关 S ₂ :Protective switch for an ammeter	施加额定工作电压 2 分钟后 The leakage current shall then be measured after an electrification period of 2 min.. 10~100 V.DC L _c ≤0.01CV 或 3 μ A 取大者 whichever is greater 160~450 V.DC L _c ≤0.02CV+10 L _c : 漏电流(μA) C: 容量(μF) V: 额定工作电压 (V) L _c : Leakage current(μA) C: Capacitance(μ F) V: Rated voltage(V)

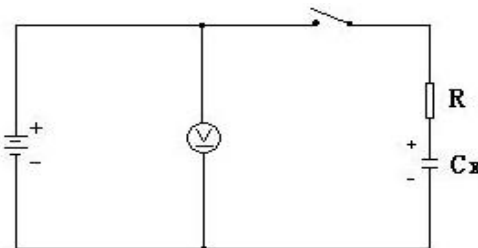
5.1.5	温度特性 Temperature Characteristic	<table border="1" style="width:100%; border-collapse: collapse; margin-bottom: 10px;"> <thead> <tr> <th style="width:15%;">阶段</th> <th style="width:45%;">温度</th> <th style="width:40%;">时间</th> </tr> </thead> <tbody> <tr> <td>1</td> <td>20±2℃</td> <td>--</td> </tr> <tr> <td>2</td> <td>-40±3℃</td> <td>2h</td> </tr> <tr> <td>3</td> <td>20±2℃</td> <td>15min.</td> </tr> <tr> <td>4</td> <td>105±3℃</td> <td>2h</td> </tr> </tbody> </table> <p>阶段 1: 测量容量和阻抗 (z 20℃ 120Hz ± 20%)</p> <p>阶段 2: 电容器恒温贮存 2 小时, 在热平衡状态测阻抗 (-40℃ 120Hz ± 20%)</p> <p>阶段 4: 电容器恒温贮存 2 小时, 在热平衡状态测电容量</p> <p>Step 1: Capacitance and impedance shall be measured. (z 20℃ 120Hz ± 20%)</p> <p>Step 2: After the capacitors being stored for 2 hours, impedance shall be made at thermal stability. (-40℃ 120Hz ± 20%)</p> <p>Step 4: After the capacitors being stored for 105℃ 2 hours, capacitance shall be measured. The measurement shall be made at thermal stability</p>	阶段	温度	时间	1	20±2℃	--	2	-40±3℃	2h	3	20±2℃	15min.	4	105±3℃	2h	阶段 2: 阻抗值与阶段 1 阻抗值相比, 不大于表 2 要求。 阶段 4: 容量变化应在初值的 ± 20% 范围内 Step 2: Impedance ratio Ratio to the value at step 1 shall be not more than the value given table-2 Step 4: Variation of capacitance Within ± 20% of the value at Step 1.
阶段	温度	时间																
1	20±2℃	--																
2	-40±3℃	2h																
3	20±2℃	15min.																
4	105±3℃	2h																
5.1.6	耐浪涌电压 Surge Test	<p>充电 30±5 秒, 放电 5.5±0.5 分钟作为一个周期, 共进行 1000 次。</p> <p>测试温度: 15℃-35℃</p> <p>然后在标准大气条件下放置达到热稳定, 测试各参数 1000 times of charging for 30±5 sec., with a period of 5.5±0.5 min..</p> <p>Test temperature: 15℃-35℃</p> <p>And the capacitors shall be stored under standard atmospheric conditions to obtain thermal stability, after which measurements shall be made.</p> <p>测试回路 Test circuit</p> 	容量: 在初始值的 ± 30% 以内。 损耗角正切值: 不大于规定值的 300%。 漏电流: 不大于规定值。 Capacitance: With ± 30% of the initial value Dissipation factor: Not more 300% of the specified Not more than the specified value Leakage current: Not more than the specified value															

		instantaneous over voltage which may be applied to terminals of capacitors, therefore, not applicable to such over voltages as often applied. 浪涌电压设定																																				
		<table border="1" style="width:100%; border-collapse: collapse; text-align: center;"> <tr> <td>RV(V)</td><td>6.3</td><td>10</td><td>16</td><td>25</td><td>35</td><td>50</td><td>63</td><td>80</td></tr> <tr> <td>S.V(V)</td><td>7.9</td><td>12.5</td><td>20</td><td>31</td><td>44</td><td>63</td><td>79</td><td>100</td></tr> <tr> <td>RV(V)</td><td>100</td><td>160</td><td>200</td><td>250</td><td>350</td><td>400</td><td>450</td><td>500</td></tr> <tr> <td>S.V(V)</td><td>125</td><td>200</td><td>250</td><td>300</td><td>400</td><td>450</td><td>500</td><td>550</td></tr> </table>	RV(V)	6.3	10	16	25	35	50	63	80	S.V(V)	7.9	12.5	20	31	44	63	79	100	RV(V)	100	160	200	250	350	400	450	500	S.V(V)	125	200	250	300	400	450	500	550
RV(V)	6.3	10	16	25	35	50	63	80																														
S.V(V)	7.9	12.5	20	31	44	63	79	100																														
RV(V)	100	160	200	250	350	400	450	500																														
S.V(V)	125	200	250	300	400	450	500	550																														

5.2 机械特性 MECHANICAL PERFORMANCE

序号 NO	项目 Item	测试方法 Test method	特性 Performance																
5.2.1	端子强度 TERMINAL STRENGTH	端子抗拉强度： 沿电容器端子引线方向施加*1N 的拉力，10 ±1 秒。 <table border="1" style="width:100%; border-collapse: collapse; text-align: center;"> <tr> <td>引线直径Φ</td><td>0.5</td><td>0.6</td><td>0.8</td></tr> <tr> <td>拉力 N</td><td>5</td><td colspan="2">10</td></tr> </table> 端子抗弯强度： 在电容器引线施加固定重力*1N，然后，将电容体弯折 90° 后回到原位，再向相反方向弯折 90° 后回到原位。 上述过程在 5 秒内完成。 <table border="1" style="width:100%; border-collapse: collapse; text-align: center;"> <tr> <td>引线直径Φ</td><td>0.5</td><td>0.6</td><td>0.8</td></tr> <tr> <td>拉力 N</td><td>2.5</td><td colspan="2">5</td></tr> </table> Tensile strength of termination: A static load of 1N shall be applied to the terminal in the down-lead direction Bending strength of termination: A static load of 1N applied to the lead wire, then bent the body through 90°, return to the original position. Next bent it in opposite direction through 90° with the same speed, again return to the original position. Carry out this operation in about 5 sec.	引线直径Φ	0.5	0.6	0.8	拉力 N	5	10		引线直径Φ	0.5	0.6	0.8	拉力 N	2.5	5		测量电容器应无接触不良、开路或短路，无可见机械损伤 When the capacitors is measured, there shall be no intermittent contacts, or open or short-circuiting. There shall be no such mechanical damage.
引线直径Φ	0.5	0.6	0.8																
拉力 N	5	10																	
引线直径Φ	0.5	0.6	0.8																
拉力 N	2.5	5																	
5.2.2	振动试验 Resistance to Vibration	依据 JIS C 5102 8.2 和 JIS C 5025 试验。 在 3 个互相垂直的方向分别施加 2 小时振动，共 6 小时 To comply with JIS C 5102 8.2 and JIS C 5025 Direction and duration of vibration: 3 orthogonal directions mutually each for 2h, Total 6h	测量电容器应无接触不良开路或短路，无可见机械损伤。 When the capacitors is measured there shall be no intermittent contacts, or open or short circuiting There shall be no such mechanical damage.																
5.2.3	可焊性 Solderability	依据 IEC60068-2-2 进行试验 焊锡温度：250 ± 5℃ 浸入时间：2.0 ± 0.5 秒 To comply with IEC60068-2-2 Temperature or solder: 250 ± 5℃ Dipping time: 2 ± 0.5 sec.	浸入焊锡的引线表面积约 90% 以上应附着新锡 At least 90% of circumferential surface of the dipping portion of termination shall be covered with new solder.																

5.3 耐久性测试 ENDURANCE PERFORMANCE

序号 NO	项目 Item	测试方法 Test method	特性 Performance																				
5.3.1	耐焊接热 Resistance to soldering heat	焊槽法： 焊锡温度：260±5℃ 浸入时间：10±1 秒 电路板：1.6mm Solder bath method Solder temperature : 260±5℃ Immersion time : 10±1sec. Printed wiring board: 1.6mm	容量变化：在初始值±10%范围内 损失角正切值：不大于规定值 漏电流：满足 5.1.4 要求 外观：无异状 Variation of capacitance: Within ±10% of the initial value before test. Dissipation factor: Not more than the specified value Leakage current: To satisfy No. 5.1.4 Appearance: No remarkable abnormality.																				
5.3.2	稳态湿热 Resistance to damp heat (steady state)	依据 JIS C 5023 进行试验 试验温度：40±2℃ 试验时间：240±8h 相对湿度：90~95% 试验后，电容器在标准大气条件下 1~2 小时，然后测试参数 To comply with JIS C 5023 Test temperature : 40±2℃ Test time : 240±8h Relative humidity: 90~95% After completion of test, the capacitors shall be subjected to standard atmospheric conditions for 1 to 2 hours, after which measurements shall be made.	容量变化：在初始值±15%范围内 损失角正切值：不大于规定值% 漏电流：满足 5.1.4 要求 外观：无异状 Variation of capacitance: Within ±15% of the initial value before test. Dissipation factor: Not more than the specified value Leakage current: To satisfy No. 5.1.4 Appearance: No remarkable abnormality.																				
5.3.3	高温负荷试验 Load life test	试验温度：125±2℃，施加含额定纹波电流的额定电压(所加电压峰值不超过)，Apply rated voltage with rated ripple current.(the peak voltage shall not exceed the rated voltage) Test temperature:125±2℃ <table border="1" style="margin-top: 10px; width: 100%; border-collapse: collapse;"> <thead> <tr> <th colspan="2">10W V_100W V</th> <th colspan="2">160W V_450W V</th> </tr> <tr> <th>外形尺寸</th> <th>负荷寿命</th> <th>外形尺寸</th> <th>负荷寿命</th> </tr> </thead> <tbody> <tr> <td>ΦD=5、6.3</td> <td>2000 小时</td> <td>ΦD=5、6.3</td> <td>2000 小时</td> </tr> <tr> <td>ΦD=8、10</td> <td>3000 小时</td> <td>ΦD=8</td> <td>3000 小时</td> </tr> <tr> <td>ΦD≥12.5</td> <td>5000 小时</td> <td>ΦD≥10</td> <td>5000 小时</td> </tr> </tbody> </table>	10W V_100W V		160W V_450W V		外形尺寸	负荷寿命	外形尺寸	负荷寿命	ΦD=5、6.3	2000 小时	ΦD=5、6.3	2000 小时	ΦD=8、10	3000 小时	ΦD=8	3000 小时	ΦD≥12.5	5000 小时	ΦD≥10	5000 小时	容量变化：在初始值±30%范围内 损耗角正切值：不超过规定值的 300% 漏电流：在规定值以内 外观：无异状 Variation of capacitance: Within ±30% of the initial value before test. Dissipation factor: Within 300% of the specified value Leakage current: Within 100% of the specified value Appearance: No remarkable abnormality.
10W V_100W V		160W V_450W V																					
外形尺寸	负荷寿命	外形尺寸	负荷寿命																				
ΦD=5、6.3	2000 小时	ΦD=5、6.3	2000 小时																				
ΦD=8、10	3000 小时	ΦD=8	3000 小时																				
ΦD≥12.5	5000 小时	ΦD≥10	5000 小时																				

上海永铭电子股份有限公司 Shanghai Yongming Electronic Co.,Ltd	铝电解电容器承认书 Aluminum Electrolytic Capacitors Specification	
--	--	---

5.3.4	高温贮存试验 Shelf life test	<p>在 $105 \pm 2^\circ\text{C}$ 环境下无负荷贮存 1000 h, 至少恢复 16 小时。</p> <p>The capacitors are then stored with no voltage applied at a temperature of $105 \pm 2^\circ\text{C}$ for 1000^{+48}_{-0} h and then resumed 16 hours, applied the rated voltage for 30 minutes.</p>	<p>容量变化率: 初始值 $\pm 20\%$ 范围内。</p> <p>损耗角正切值: 不超过规定值的 200%</p> <p>漏电流: 不超过规定值的 200%</p> <p>外观: 无异状</p> <p>Variation of capacitance: Within $\pm 20\%$ of the initial value before test.</p> <p>Dissipation factor: Not more than 200% of the specified value</p> <p>Leakage current: Not more than 200% of the specified value</p> <p>Appearance: No remarkable abnormality.</p>
5.3.5	低温储存: Low temperature storage	<p>环境温度 $-40^\circ\text{C} \pm 2^\circ\text{C}$ ambient temperature $-40^\circ\text{C} \pm 2^\circ\text{C}$ 持续时间: 240 小时 Time: 240 Hours 恢复时间: 至少 16 小时 Recovery time: at least 16 hours</p>	<p>100Hz 下测试, 电容量变化率 $\Delta C/C \leq \pm 20\%$; Test at 100HZ, capacitance change $\Delta C/C \leq \pm 20\%$; 100Hz 下测试, 损耗 $\text{tg}\delta \leq$ 规格值; Test at 100HZ, DF $\text{tg}\delta \leq$ specified value 漏电流 \leq 规格值; Leakage current \leq specified value 试验后电容器无可见损伤和电解质漏出。 No visible damage and electrolytic leakage after testing capacitor.</p>
5.3.6	防爆试验 Safety vent	<p>在电容器两极施加直流反向电压 100V, 其中通过的电流设置应不大于 1A, 在测试时防爆装置应能在 30 分钟内动作。</p> <p>D. C. Application test The capacitors shall be subjected to a reverse D.C.100 voltage equal to the rated D.C.voltage. The current flowing through the capacitors shall be limited to 1A. If the vent does operate with the voltage applied for 30 minutes, the test is considered to be passed.</p>	<p>上述过程中应无引线、铝箔等散射, 无火花产生。</p> <p>The vent device is actuated under the test conditions, thereby preventing terminals, metal pieces, etc, of the capacitors from scattering due to burst, the case from separating from the seal packing, or the capacitors from producing flame.</p>

名称	Name	承认书 Specification		
版本	Version	03	页数	Page
			10	
标准指南		Standard manual		

表 2 Table 2

阻抗比 Max. impedance ratio (120Hz)	额定工作电压 Rsted voltage(□□)	10	16	25	35	50	63	80	100
	$ z _{-40^{\circ}\text{C}}/ z _{20^{\circ}\text{C}}$	6	4	3	3	3	3	3	3
	额定工作电压 Rsted voltage (v)	160	200	250	350	400	450	500	
	$ z _{-40^{\circ}\text{C}}/ z _{20^{\circ}\text{C}}$	5	5	5	7	7	7	8	

6. 标记 MARKING

Φ4 及以下印字模板
Φ5 和 Φ6.3 印字模板
Φ8 及以上印字模板

6. 1 在电容器体上注明有如下内容:

- | | |
|------------|--------------|
| 6.1.1 静电容量 | 6.1.2 额定工作电压 |
| 6.1.3 型号规格 | 6.1.4 负极标志 |
| 6.1.5 生产周期 | |

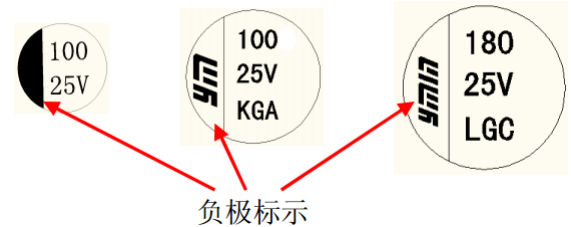

6.1 The following items shall be marked indelibly on the capacitors.

- | | |
|------------------------------|---------------------------------|
| 6.1.1 static capacity | 6.1.2 Rated operational voltage |
| 6.1.3 Type and specification | 6.1.4 Polarity of the terminals |
| 6.1.5 Manufacture time | |

6. 2 针对电容器体上信息举例说明:

3. 2. 1 100 代表静电容量;
 3. 2. 1 100 represents electrostatic capacity
3. 2. 2 25V 代表产品额定工作电压;
 3. 2. 2 25V represents the rated working voltage of the product
3. 2. 3 K 代表产品系列, 其中产品系列与对应表示字母列出如下:

系列	VK0	VKF	VKG	VKL	VK7	VKJ	VKM	VMM	V3M	V4M
代表字母	K	F	G	L	7	J	M	2	3	4

3. 2. 4 G 代表产品生产年份, 其中产品生产年份与对应表示字母列出如下:

生产年份	2013	2014	2015	2016	2017	2018	2019	2020	2021	2022	...	2038
代表字母	A	B	C	D	E	F	G	H	J	K	...	Z

2. 3. 5 A 代表产品生产月份, 其中产品生产年份与对应表示字母列出如下

生产月份	1	2	3	4	5	6	7	8	9	10	11	12
代表字母	A	B	C	D	E	F	G	H	J	K	L	M







上海永铭电子股份有限公司 Shanghai Yongming Electronic Co.,Ltd	铝电解电容器承认书 Aluminum Electrolytic Capacitors Specification	
--	--	---

7. 包装 PACKING

7.1 包装标签 PACKING LABEL

内标签样本 inner a label sample

外箱标签样本 outer box a label sample

 Certification 合格证 				 上海永铭电子股份有限公司  SHANGHAI YONGMING ELECTRONIC CO.,LTD					
Product name: 产品名称	VKM_250V_4.7 μ F_6.3*10_-20%+ 20%_透明胶管			产品名称/ Product name:	VKM_250V_4.7 μ F_6.3*10_-20%+20 %_透明胶管				
LOT NO: 生产批号	YM170504659-4	QTY: 数量	4200 PCS	产品编号/ Product NO:	620849	数量/QTY:	12600 PCS		
Production date 生产日期	2017-06-07	Product NC 产品编号	620849	批号/LOT NO:	SC0370060717		净重/NW:	KG	
Customer Item Code: 客户物料描述				生产日期/ Production date:	2017-6-7		毛重/GW:	KG	
				客户物料描述/Customer Item Code:					
				QC:					

包装标签内容 Packing Label Marked (the following items shall be marked on the label)

(Inside box or bag、shipping carton)

- 1) 产品名称 Product name
- 2) 生产批号 Lot No
- 3) 数量 quantity
- 4) 生产日期 Production date
- 5) 产品编号 Part No
- 6) 客户物料描述 Customer item code

7.2 批号 Lot number:

Production batch number rules for labels of inner package:

产品批号编码规则

1	2	3	4	5	6	7	8	9	10	11	12	13
YM		year		month		matrial code	production number				serial number	

名称 Name	承认书 Specification	
版本 Version	03	页数 Page 12
标准指南 Standard manual		

7.3. 编带尺寸 Taping Dimensions

Fig.1

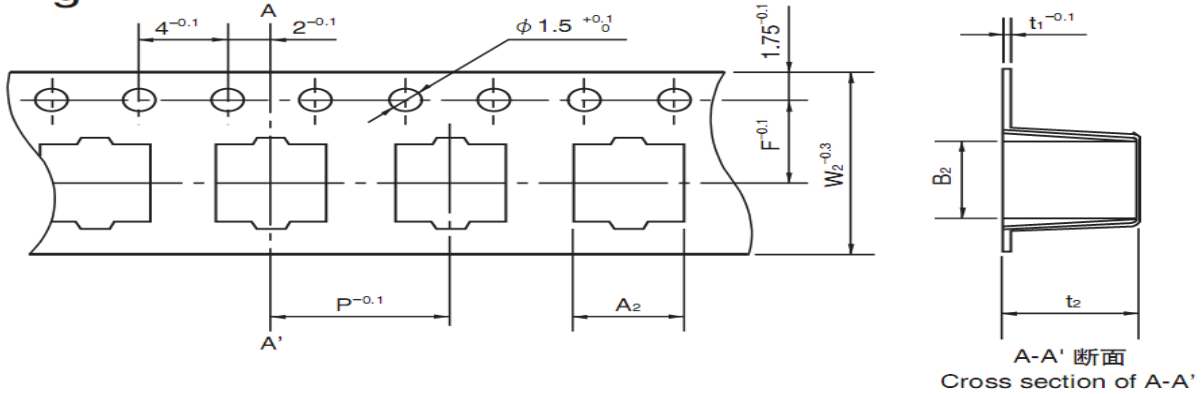
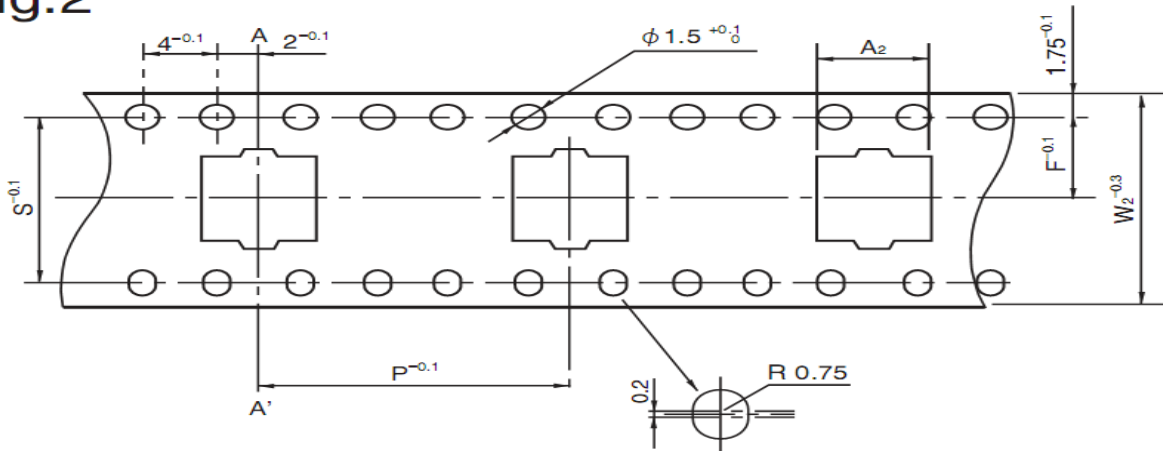

Fig.2



尺寸 Size	W2 (mm)	A2 (mm)	B2 (mm)	P (mm)	t2 (mm)	F (mm)	t1 (mm)	S (mm)	形状 Applicable
Φ5×7.7	16	5.7	5.7	12	8.6	7.5	0.4	—	Fig.1
Φ5×10	16	5.7	5.7	12	11	7.5	0.5	—	
Φ5×12	16	5.7	5.7	12	2	7.5	0.5	—	
Φ6.3×7.7	16	7.0	7.0	12	8.6	7.5	0.4	—	
Φ6.3×10	16	6.8	6.8	12	11	7.5	0.5	—	
Φ6.3×12	16	6.8	6.8	12	12	7.5	0.5	—	
Φ8×7.7	16	8.7	8.7	16	8.6	11.5	0.4	—	
Φ8×10	24	8.7	8.7	16	11.0	11.5	0.4	—	
Φ8×12.5	24	8.7	8.7	16	13.0	11.5	0.4	—	
Φ8×14.5	24	8.7	8.7	16	15	11.5	0.5	—	

名称 Name	承认书 Specification	
版本 Version	03	页数 Page
标准指南 Standard manual		13

Φ8×16.5	24	8.7	8.7	16	17.5	11.5	0.5	—	Fig.2
Φ8×20.5	24	8.7	8.7	24	21.5	14.2	0.5	—	
Φ10×7.7	24	10.7	10.7	16	9.0	11.5	0.4	—	
Φ10×10	24	10.7	10.7	16	11.0	11.5	0.4	—	
Φ10×13	24	10.7	10.7	16	5	11.5	0.5	—	
Φ10×14.5	24	10.7	10.7	16	1	11.5	0.5	—	
Φ10×16.5	24	10.7	10.7	16	17	11.5	0.5	—	
Φ10×21	32	10.7	10.7	24	21.5	11.5	0.5	28.4	
Φ12.5×14.5	32	13.4	13.4	24	14.5	14.2	0.5	28.4	
Φ12.5×16.5	32	13.4	13.4	24	17.5	14.2	0.5	28.4	
Φ12.5×21	32	13.4	13.4	24	21.5	14.2	0.5	28.4	
Φ16×16.5	44	17.5	17.5	28	17.5	20.2	0.5	40.4	
Φ16×21	44	17.5	17.5	28	22.0	22.2	0.5	40.4	
Φ18×16.5	44	19.2	19.2	32	17.5	20.2	0.5	40.4	
Φ18×21	44	19.2	19.2	32	22.0	20.2	0.5	40.4	
Φ20×16.5	44	21.5	21.5	36	17.5	20.2	0.5	40.4	
Φ20×21.5	44	21.5	21.5	36	22.0	20.2	0.5	40.4	

7.4 料盘和包装数量 Taping Reel and Packing Quantity

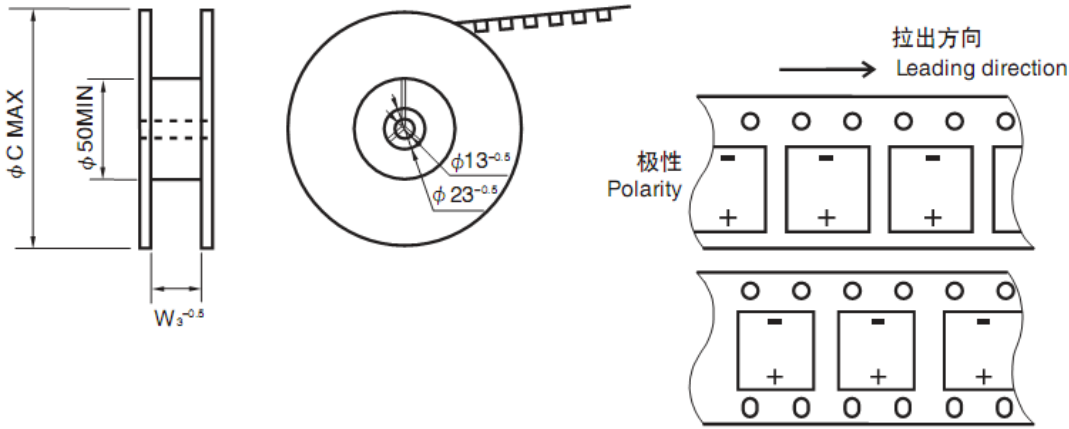

尺寸 Size	W3 (mm)	φ C (mm)	1 卷筒数量 pcs/reel	内盒内料盘数 Reels/carton	内盒包装数量 (pcs/carton)	标准外箱包装数 Standard shipping Carton Quantit (pcs)
Φ5*7.7	18	382	900	6	5400	16200
Φ5*10	18	382	700	6	4200	12600
Φ5*12	18	382	500	6	3000	9000

Φ6.3*7.7	18	382	900	6	5400	16200
Φ6.3*10	18	382	700	6	4200	12600
Φ6.3*12	18	382	500	6	3000	9000
Φ8*7.7	26	382	600	5	3000	9000
Φ8*10	26	382	500	5	2500	7500
Φ8*12.5	26	382	400	5	2000	6000
Φ8*13.5	26	382	400	5	2000	000
Φ8*14.5	26	382	350	5	1750	5250
Φ8*16.5	26	382	350	5	1750	5250
Φ8*20.5	26	382	200	5	1000	3000
Φ10*7.7	26	382	600	5	3000	9000
Φ10*10	26	382	500	5	2500	7500
Φ10*13.5	26	382	400	5	2000	6000
Φ10*14.5	26	382	350	5	1750	5250
Φ10*16.5	26	382	350	5	1750	5250
Φ10*21	34	382	200	4	800	2400
Φ12.5*13.5	3	382	250	4	1000	3000
Φ12.5*16.5	34	382	200	4	800	2400
Φ12.5*21	34	382	175	4	700	2100
Φ16*16.5	46	382	150	4	600	1800
Φ16*21.5(21)	46	382	120	3	360	1080
Φ18*16.5	46	382	150	3	450	1350
Φ18*21.5(21)	46	382	120	3	360	1080
Φ20*16.5	46	382	150	3	450	1350
Φ 0*21.5	46	382	120	3	360	1080



8. 产品编码规则

Product Code Rules

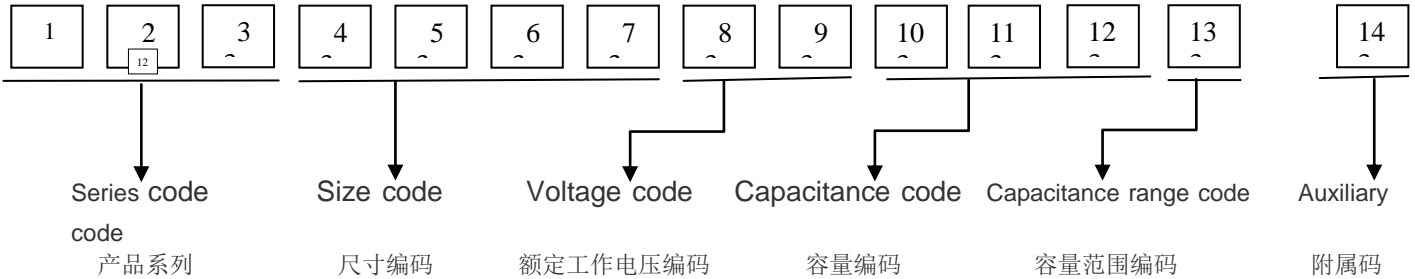

产品系列	
系列	编码
LMM	LMM
LK7	LK7
LK	OLK
LKF	LKF
LKG	LKG
LKL	LKL
LLK	LLK
GP	OGP
LKM	LKM
LKZ	LKZ
KC	OKC
PKC	PKC
LKJ	LKJ
LKX	LKX
VK7	VK7
VKO	VKO
VKG	VKG
VKL	VKL
VKM	VKM
VMM	VMM
NP1	NP1
NPX	NPX
NPH	NPH
NPT	NPT
NPL	NPL
VP1	VP1
VPX	VPX
VPH	VPH
VPT	VPT
VPL	VPL

额定工作电压	
电压	编码
4V	0G
6.3V	0J
7.5V	0L
10V	1A
16V	1C
20V	1D
25V	1E
30V	1P
35V	1V
40V	1G
50V	1H
63V	1J
80V	1K
100V	2A
120V	2K
160V	2C
200V	2D
250V	2E
350V	2V
400V	2G
450V	2W
480V	2L
500V	2H
550V	2I
600V	2J

静电容量			
容量	编码	容量	编码
0.1 μF	0R1	33 μF	330
0.22 μF	R22	47 μF	470
0.33 μF	R33	56 μF	560
0.47 μF	R47	68 μF	680
0.68 μF	R68	82 μF	820
0.82 μF	R82	100 μF	101
1.0 μF	1R0	120 μF	121
1.2 μF	1R2	150 μF	151
1.5 μF	1R5	180 μF	181
1.8 μF	1R8	220 μF	221
2.2 μF	2R2	270 μF	271
2.7 μF	2R7	330 μF	331
2.8 μF	2R8	470 μF	471
3.0 μF	3R0	560 μF	561
3.3 μF	3R3	680 μF	681
3.6 μF	3R6	820 μF	821
3.9 μF	3R9	1000 μF	102
4.0 μF	4R0	1200 μF	122
4.7 μF	4R7	1500 μF	152
5.6 μF	5R6	1800 μF	182
6.0 μF	6R0	2200 μF	222
6.2 μF	6R2	2700 μF	272
6.8 μF	6R8	3300 μF	332
8.2 μF	8R2	3900 μF	392
10 μF	100	4700 μF	472
12 μF	120	5600 μF	562
13 μF	130	6800 μF	682
15 μF	150	8200 μF	822
18 μF	180	10000 μF	103
22 μF	220	22000 μF	223
27 μF	270	33000 μF	333

容量范围	
级别	编码
±20%	M
±10%	K
0~+10%	R
0~-10%	T
-10~+20%	V
-20~+5%	L
-10~+5%	G
-10~+15%	H
0~+40%	I
±15%	J
-20~+50%	A
-5~-20%	B
-5~+20%	E
-15~+5%	C
-15~-5%	D
0~+20%	F
0~+15%	N
-5~+15%	W
-20~+0%	S
-20~+10%	P
0~+5%	Q

附属码		附属码	
附属码 (国内)		附属码 (IND)	
O	引线 30F/35F	2	引线 30F/35F
H	引线 33F/38F	3	引线 33F/38F
F	引线 22F/27F	4	切直脚 A 图
A	切直脚 A 图	5	切脚成型 B 图
B	切脚成型 B 图	6	切脚成型 C 图
C	切脚成型 C 图	7	切脚成型 D 图
D	切脚成型 D 图	8	切脚成型 E 图
E	切脚成型 E 图	9	引线 22F/27F
Q	切脚折弯 90° F 图 A 型 (右)	M	编带 A 图
P	切脚折弯 90° F 图 B 型 (左)	N	编带 B 图
X	切脚成型 G 图		
g	切脚双折弯 90° F 图 A 型 (右)		
f	切脚双折弯 90° F 图 B 型 (左)		
K	编带 A 图		
J	编带 B 图		
V	液态 SMD		
j	固态		
TM	涂膜铝壳		



外形尺寸

产品直径	编码	产品高度	编码	产品高度	编码
3.5	F	3.55	035	15	150
4	A	3.95	039	16	160
4.5	G	4.5	045	16.5	165
5	B	5	050	17	170
5.5	H	5.4	054	18	180
6.3	C	5.8	058	19	190
8	D	6.5	065	20	200
10	E	7	070	21	210
12.5	L	7.7	077	22	220
16	I	8	080	23	230
18	J	8.5	085	25	250
20	N	9	090	28	280
22	K	9.5	095	30	300
25	M	10	100	31.5	315
30	P	10.5	105	32	320
35	Q	11	110	35.5	355
40	R	11.5	115	36	360
		12	120	40	400
		12.5	125	41.5	415
		13	130	45	450
		13.5	135	50	500
		14	140		
		14.5	145		

9、贴片电解使用时应满足以下条件：

Below requirement should be met when use SMD capacitors

无铅型回流焊允许条件 Lead free type reflow soldering condition :

铝壳尺寸 $\phi 5 \sim \phi 10\text{mm}$ size $\phi 5 \sim \phi 10\text{mm}$

电容器表面温度在 $T^\circ\text{C}$ 以下； Temperature at surface of capacitor should below $T^\circ\text{C}$.

电容器表面温度在 200°C 以上的时间不能超过 t 秒。 $T_1^\circ\text{C}$ 以上的时间不可超过 t_1 ；

The time of the surface temperature of the capacitors above 200°C cannot exceed t second.

The time of the surface temperature of capacitors above $T_1^\circ\text{C}$ can not exceed t_1 .

预热控制在 $100^\circ\text{C} \sim 200^\circ\text{C}$ 180 秒以内。

Preheat should be made between $100^\circ\text{C} \sim 200^\circ\text{C}$ and for maximum 180 seconds.

系列名称 Series	产品尺寸 size	T ($^\circ\text{C}$) ①	T ₁ ($^\circ\text{C}$)	t (sec) ②	t ₁ (sec) ③	回流焊次数 Reflow cycle
V7、VK7	$\Phi 5 \sim \Phi 10$	240	220	60	40	1
VO、VKO VG、VKG VF、VKF VM、VKM VL、VKL	$\Phi 5 \sim \Phi 6.3$	250	230	90	40	1
	$\Phi 8$	240	230	90	30	1
	$\Phi 10$	235	230	60	30	1

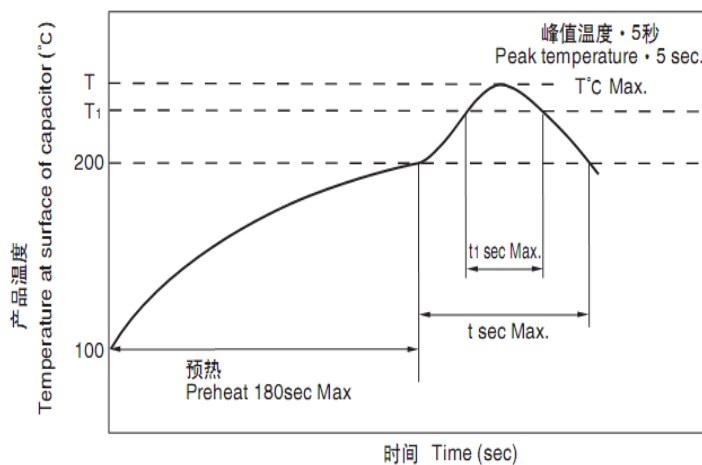

① 峰值温度 peak temperature

② 超过 200°C 的时间 (MAX)
Max time above 200°C

③ 超过 T_1 的时间为 (MAX)
Max time above T_1

出现超过允许条件的情况，请联系我们。

If other condition over maximum, please contact us.

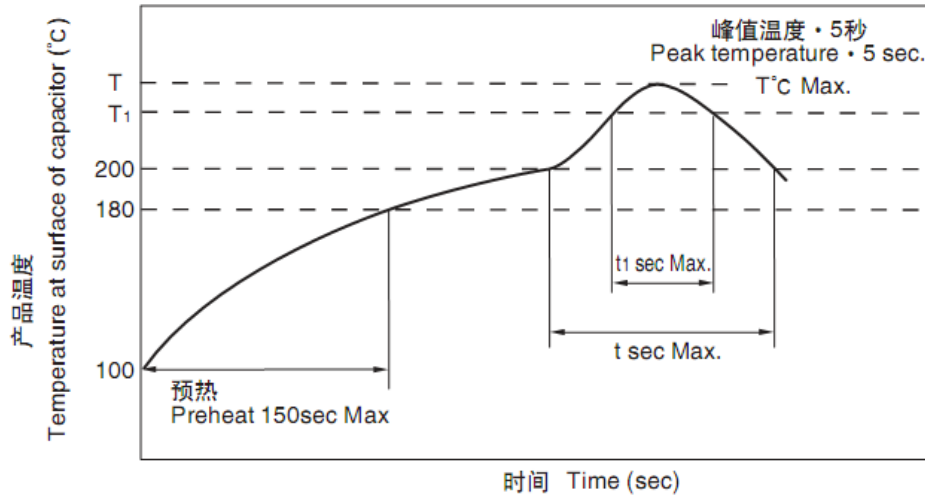

产品尺寸 size	T (°C) ①	T ₁ (°C)	t (sec) ②	t ₁ (sec)	回流焊次数 Reflow cycle
Φ12.5~Φ20	240	230	60	30	1

无铅型回流焊允许条件 Lead free type reflow soldering condition

铝壳尺寸 φ12.5~φ20mm size φ12.5~φ20mm

电容器表面温度在 T°C以下 Temperature at surface of capacitor should below T °C

电容器表面温度在 200°C以上的时间不能超过 t 秒。T₁°C以上的时间不可超过 t₁ 秒

The time of the surface temperature of the capacitors above 200 °C cannot exceed t second.

The time of the surface temperature of capacitor above T₁ °C cannot exceed t₁.

预热控制在 100°C~180°C 150 秒以内。

Preheat should be made between 100-180 °C and maximum 150 seconds.

带辅助端子的抗振结构产品

Vibration proof packages with the supporting terminal.

对于外壳尺寸在 φ8 以上的贴切片型电容器，可带有抗振结构。

For chip Aluminum electrolytic capacitors more than can size (Φ8, vibration proof packages supports.

.当出现错焊时请进行手动重焊。此时，请设定烙铁尖端温度为 380±10°C，对电容器进行 3±0.5 秒的焊接。

When there is mistake during soldering, please re-solder manually, the temperature of soldering iron should be set at 380±10 °C, and the soldering time on capacitor is 3 ±0.5 seconds.

上海永铭电子股份有限公司 Shanghai Yongming Electronic Co.,Ltd	铝电解电容器承认书 Aluminum Electrolytic Capacitors Specification	
--	--	---

10. 其他 The others

10.1 铝电解电容器的应用注意事项

Caution for proper use of aluminium electrolytic capacitors

12.1.1. 电解电容是有极性的 DC electrolytic capacitors are polarized

当施加反向直流电压时，电容器将损坏，电路中使用没有极化电容会被损坏，因为可施加到正电压的阴极端子的电路中流过异常电流。 When reverse voltage is applied on DC electrolytic capacitors, the capacitors will become short-circuited。 please use no polarized capacitors in the circuit be damage due to abnormal current flows through the capacitors since the circuit where the positive voltage may be applied to the cathode terminal.

10.1.2.施加电容器的额定电压 Use capacitors within rated voltage

当电容器用比额定电压更高的电压时，漏电流增加，特性显著恶化，并在很短的时间内发生损坏的结果。请特别小心的峰值电压不应超过额定电压。 When capacitors is used at higher voltage than the rated voltage, leakage current increases, characteristics drastically deteriorate and damage in a short period may occur as a result. Please take extra caution that the peak voltage should not exceed the rated voltage.

10.1.3. 充电和放电 Charge and discharge application.

当铝电解电容器用于快速充电和放电的应用，其寿命可缩短减少，热量上升，等等。

When aluminum electrolytic capacitors for general purpose are employed in rapid charge and discharge application, its life expectancy may be shortened by capacitance decrease, heat rise, etc.

10.1.4. 存储 Store the capacitors.

在已经存储了长时间的铝电容器其漏电流上升是常见的。存储温度越高，漏电流增大，因此，请采取预防措施，如存储环境。有电压被施加到电容器上时其漏电流逐渐减小。漏电流增加，会造成问题，因此，使用前在电路中施加电压（老化）。 Increased leakage current is common in aluminum capacitors which have been stored for long period of time. The Higher the storage temperature, the higher the leakage current increase,

therefore please take precautions concerning the storage location. The leakage current decreases

gradually as voltage are applied to the capacitor. In cases where increased leakage current causes problems in the circuit, apply voltage (aging) before using.

10.1.5 适用于电容器的纹波电流不应超过额定的值

Ripple current applied to capacitors should not exceed the rated value.

如果纹波电流超过指定值，过多的热量会减少容量和缩短电容寿命。因此纹波电压的峰值应不超过额定值。

名称	Name	承认书 Specification		
版本	Version	03	页数	Page 20
标准指南 Standard manual				

上海永铭电子股份有限公司 Shanghai Yongming Electronic Co.,Ltd	铝电解电容器承认书 Aluminum Electrolytic Capacitors Specification	
--	--	---

Excessive heat will reduce capacitance and result in shortened life of capacitor if ripple currents exceeding the specified rated value are applied. The peak value of the ripple voltage should be less than the rated voltage.

10.1.6. 环境温度 Ambient temperature.

铝电解电容器的寿命受环境温度的影响。人们普遍表示, 温度每下降 10℃ 寿命加倍。Life of the aluminum electrolytic capacitor is affected by the ambient temperature. It is generally stated, that life doubles for each 10°C decrease in temperature.

10.1.7. 引线的强度 Intensity of lead

加到引线或端子, 应力的内部连接。这可能会导致短路, 开路或漏电流增加。在电容器已被焊接到 PC 板上后, 弯曲或后处理电容器是不可取的。

When a strong force is applied to the lead wires or terminals, stress is put on the internal connections. This may result in short circuit, open circuit or increased leakage current. It is not

10.1.8 在焊接过程中的耐热性 Heat resistance at the soldering process

在 PC 板上安装铝电解电容器的浸焊工艺中, 观察到 PET 外套二次收缩或开裂时, 焊料的温度太高或浸渍时间太长。advisable to bend or handle a capacitors after it has been soldered to the PC board.

In the dip soldering process of PC board with aluminum electrolytic capacitors mounted, secondary shrinkage or crack of PET sleeve may be observed when solder temperature is too high or dipping time is too long.

10.1.9. PC 板的孔间距和位置 Hole pitch and position of PC board.

设计印刷电路板, 其孔距适合指定的目录或规格的电容的引线间距 (铅的间距)。当电容器强行插入一个孔间距时, 把应力加在引线。这可能会导致短路或漏电流增加。

capacitor specified by the catalog or specifications. When a capacitor is forcibly inserted into an unmatched hole A PC board must be designed so its hole pitch coincides with the lead pitch (lead spacing) of the pitch, a stress is put on the leads. This could result in a short circuit or increased leakage current.

10.2 该产品是无铅和环保 This product is lead free and environmental friendly. (SHMLP2025931105, SGS)

产品按照 ROHS 的标准, 六种有害物质最大不超过下列要求: This products according to the standard of ROHS,it means the max capacitance Of six harmful material not over the following request:

Cd -100PPM	Pb -1000PPM	Hg -1000PPM
Cr+-1000PPM	PBBs -1000PPM	PBDEs -1000PPM

名称	Name	承认书			Specification
版本	Version	03	页数	Page	21
标准指南		Standard manual			

X-ON Electronics

Largest Supplier of Electrical and Electronic Components

Click to view similar products for [Aluminium Electrolytic Capacitors - SMD category](#):

Click to view products by [Ymin manufacturer](#):

Other Similar products are found below :

[ULV2H4R7MNL1GS](#) [ULV2H1R8MNL1GS](#) [EMZA500ARA221MJA0G](#) [MAL214099813E3](#) [CA025M4R70REB-0405](#)
[UCX1V471MNQ1MS](#) [10SVP120M](#) [DV100M050C055ETR](#) [RVJ-50V101MH10U-R](#) [AEH1012471M016R](#) [MAL213967339E3](#)
[GVT1C337M0608CNVC](#) [EMK1EM331FB0D00R](#) [EMF1CM221FB0D00R](#) [EMF1CM331FB0D00R](#) [EMF1CM471FB0D00R](#)
[EMK1JM101GB0D00R](#) [EMK1AM102GB0D00R](#) [EMK1HM221GB0D00R](#) [DV221M6R3E055ETR](#) [DV221M025E077ETR](#)
[RV331M025F105ETR](#) [RVT1A101M0505](#) [GVZ1H101M0607](#) [CK1E100M0405](#) [GVM1E331M0607](#) [VT10UF100V167RV0127](#)
[VT100UF16V167RV0124](#) [CS100UF35V167RV0155](#) [CK220UF16V167RV0142](#) [VT10UF16V167RV0128](#) [VT22UF35V167RV0131](#)
[CS470UF10V167RV0150](#) [CK100UF16V167RV0138](#) [CK220UF10V167RV0141](#) [RVT330UF25V167RV0055](#) [VT470UF16V167RV0135](#)
[CS100UF10V167RV0144](#) [126RV0017](#) [VT47UF35V167RV0137](#) [CS220UF35V167RV0148](#) [126RV0010](#) [126RV0009](#)
[VT220UF25V167RV160](#) [VT220UF16V167RV0088](#) [126RV0012](#) [126RV0011](#) [126RV0013](#) [126RV0018](#) [126RV0008](#)