

SPECIFICATIONS

- Voltage rating: 50V AC, DC
- Current rating: 1A, AC, DC
- Withstanding voltage: 500V AC/minute
- Insulation resistance: 1000M Ω min
- Temperature range: -40°C - +105 ° C
- Contact resistance: 20m Ω max

WAFER

- Part No. :CS-1254R-XX
- Poles:2-16
- Material: LCP, NATURAL COLOR , UL94V-0
- Contact: C2680, Tin plated
- Q' TY: 1,000 pcs/bag

Poles	PART NO	DIMENSION (mm)	
		A	B
2	CST-1254R-02	1.00	4.00
3	CST-1254R-03	2.00	5.00
4	CST-1254R-04	3.00	6.00
5	CST-1254R-05	4.00	7.00
6	CST-1254R-06	5.00	8.00
7	CST-1254R-07	6.00	9.00
8	CST-1254R-08	7.00	10.00
9	CST-1254R-09	8.00	11.00
10	CST-1254R-10	9.00	12.00
11	CST-1254R-11	10.00	13.00
12	CST-1254R-12	11.00	14.00
13	CST-1254R-13	12.00	15.00
14	CST-1254R-14	13.00	16.00
15	CST-1254R-15	14.00	17.00
16	CST-1254R-16	15.00	18.00

ROHS 2.0

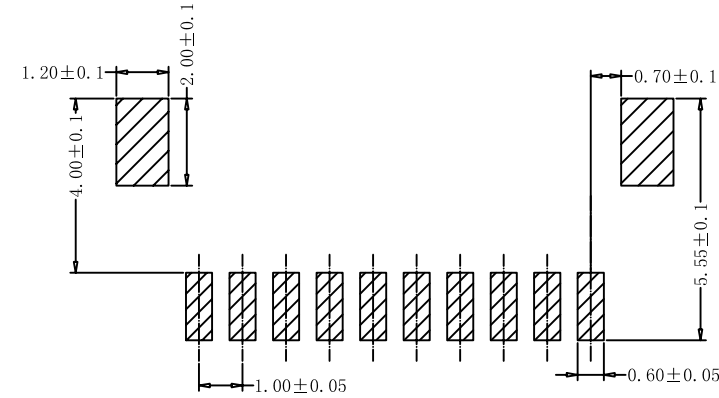
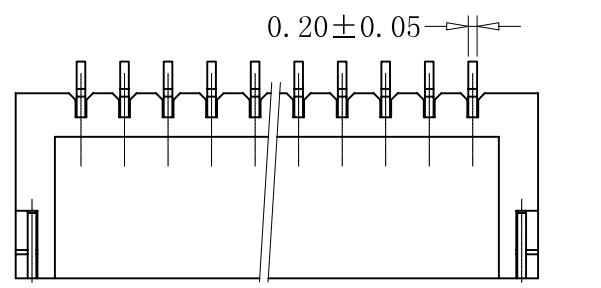
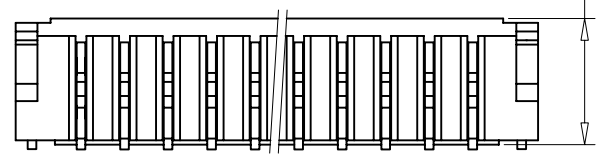
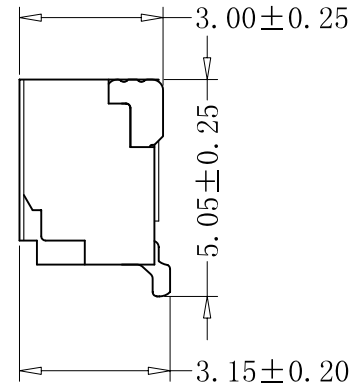
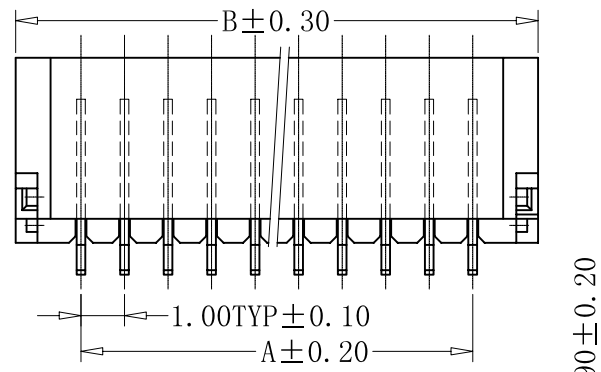

本圖紙知識產權及版權由永丰盈有限公司所有,未經書面許可不准擅自傳閱、复制和修改。本公司保留法律追究的权利。

类别	WAFER	品名	CS-1254R-XX	X.	±0.50	材料		单位	mm	SHEET 1 OF 1	
版本	A/1	设计	李文畅	X.X	±0.30	颜色		比例	1:1	▲	修改内容
制定部门	工程课	绘制	李文畅	X.XX	±0.20	画法		数量		▲	加储存方式
工程图号	CST-1254R	审核	姚培柱	X.XXX	±0.10	CST 深圳市永丰盈电子有限公司 ShenZhenYongFengYing ELECTRONICS CO.,LTD.				▲	
制定日期	2017-11-30	核准	周中湖	X.XXXX	±0.05					▲	

scale:1:4

针脚在前

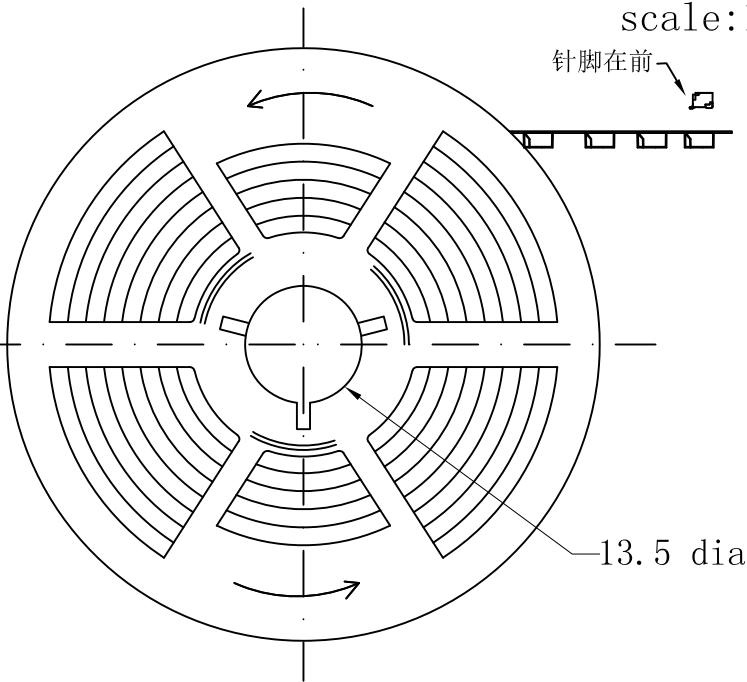

13.5 dia

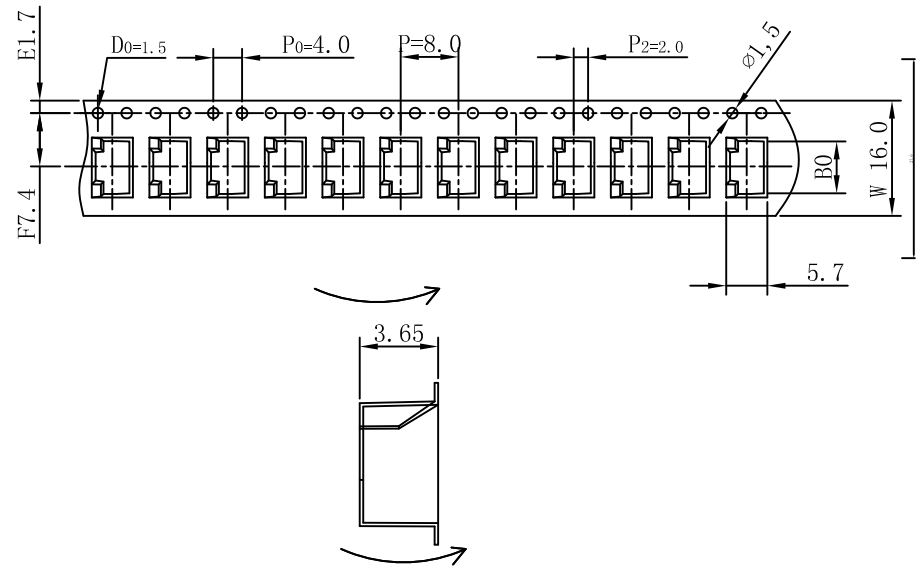
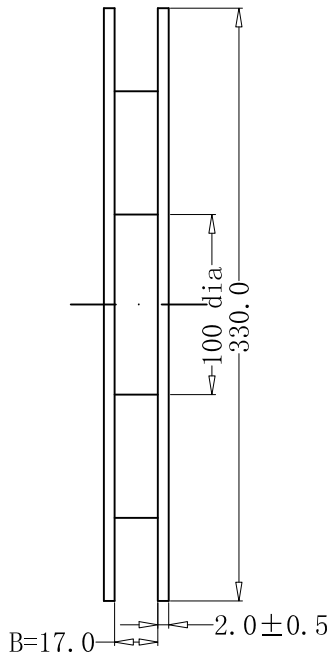

每卷数量: 2000pcs/卷

外箱: 18卷/箱 (340mm*340mm*400mm)

Poles	PART NO	DIMENSION (mm)		
		W	F	B0
2	CS-1254R-02	16.0	7.4	4.6
3	CS-1254R-03	16.0	7.4	5.6
4	CS-1254R-04	16.0	7.4	6.6
5	CS-1254R-05	16.0	7.4	7.6
6	CS-1254R-06	16.0	7.4	8.6
7	CS-1254R-07	24.0	13.2	9.6
8	CS-1254R-08	24.0	13.2	10.6
9	CS-1254R-09	24.0	13.2	11.6
10	CS-1254R-10	24.0	13.2	12.6

* 本图纸知识产权及版权由永丰盈电子公司所有, 未经许可不准擅自复制和修改, 本公司保留法律追究的权利.

SORT	卷装图	PART NO.	CS-1254R-XX	X.	±0.30	MATERIAL		UNIT	mm	SHEET	4 OF 4
VERSION	A/0	DESIGNER		X.X	±0.20	COLOUR		SCALE	1:1	REVISE	REVISE DATE
FRAME	ENGINEER DEPARTMENT	DRAW BY	WENCHANG LI	X.XX	±0.10	PROJECTION		QUANTITY			
DRAWING NO.	CS-1254	CHECK BY	PEIZHU YAO	X.XXX	±0.05	永丰盈电子有限公司 YONG FENG YING ELECTRONIC LTD.					
DATE	2018-06-15	APPROVE	ZHICHENG WEI	X.XXXX	±0.02						

X-ON Electronics

Largest Supplier of Electrical and Electronic Components

Click to view similar products for [Headers & Wire Housings](#) category:

Click to view products by [Yongfengying Electronics](#) manufacturer:

Other Similar products are found below :

[57102-F02-18ULF](#) [58102-G61-06LF](#) [582553-1](#) [009176003701906](#) [01.001.5753.1](#) [0050291907](#) [02.125.8002.8](#) [609-3404](#) [61062-3](#)
[CSU011177004](#) [622-0430](#) [622-3653LF](#) [63453-116](#) [636-1030](#) [636-1427](#) [636-3427](#) [636-4007](#) [641938-9](#) [65495-038](#) [65692-001LF](#) [65781-018](#)
[65781-047](#) [65817-010LF](#) [65817-015LF](#) [66207-023LF](#) [67095-007LF](#) [67601157](#) [68631-112](#) [68645-018](#) [699319-000](#) [M90C108951C](#)
[70.362.1628.0](#) [70-4210](#) [70-4226B](#) [70-4853B](#) [707-5028](#) [71.350.2428.0](#) [71961-016LF](#) [733-134](#) [733-162](#) [754199-000](#) [760-3052](#) [80.063.4001.1](#)
[800-90-001-10-001000](#) [800-90-010-10-002000](#) [801-43-002-10-013000](#) [801-43-006-10-002000](#) [803-41-018-10-001000](#) [803-43-024-10-](#)
[001000](#) [803-93-012-10-001000](#)