

Plastic-Encapsulate MOSFETS

N-channel MOSFET

FEATURES

- Low on-resistance
- Fast switching speed
- Low voltage drive makes this device ideal for portable equipment
- Easily designed drive circuits
- Easy to parallel

SOT-323

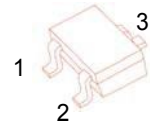

1. GATE
2. SOURCE
3. DRAIN

Marking: KN

MOSFET MAXIMUM RATINGS (T_a = 25°C unless otherwise noted)

Symbol	Parameter	Value	Units
V _{DS}	Drain-Source voltage	30	V
V _{GSS}	Gate-Source Voltage	±20	V
I _D	Continuous Drain Current	0.1	A
P _D	Power Dissipation	0.2	W
T _J	Junction Temperature	150	°C
T _{stg}	Storage Temperature	-55-150	°C
R _{θJA}	Thermal Resistance from Junction to Ambient	625	°C /W

Equivalent circuit

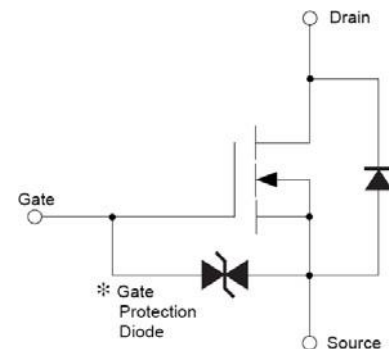

MOSFET ELECTRICAL CHARACTERISTICS(T_a=25°C unless otherwise noted)

Parameter	Symbol	Test Condition	Min	Typ	Max	Units
Off Characteristics						
Drain-Source Breakdown Voltage	V _{(BR)DSS}	V _{GS} = 0V, I _D = 10μA	30			V
Zero Gate Voltage Drain Current	I _{DSS}	V _{DS} = 30V, V _{GS} = 0V			0.2	μA
Gate -Source leakage current	I _{GSS}	V _{GS} = ±20V, V _{DS} = 0V			±2	uA
Gate Threshold Voltage	V _{GS(th)}	V _{DS} = 3V, I _D = 100μA	0.8		1.5	V
Drain-Source On-Resistance	R _{DS(on)}	V _{GS} = 4V, I _D = 10mA			8	Ω
		V _{GS} = 2.5V, I _D = 1mA			13	Ω
Forward Transconductance	g _{FS}	V _{DS} = 3V, I _D = 10mA	20			mS
Dynamic Characteristics*						
Input Capacitance	C _{iss}	V _{DS} = 5V, V _{GS} = 0V, f = 1MHz		13		pF
Output Capacitance	C _{oss}			9		pF
Reverse Transfer Capacitance	C _{rss}			4		pF
Switching Characteristics*						
Turn-On Delay Time	t _{d(on)}	V _{GS} = 5V, V _{DD} = 5V, I _D = 10mA, R _g = 10Ω, R _L = 500Ω		15		ns
Rise Time	t _r			35		ns
Turn-Off Delay Time	t _{d(off)}			80		ns
Fall Time	t _f			80		ns

Typical Characteristics

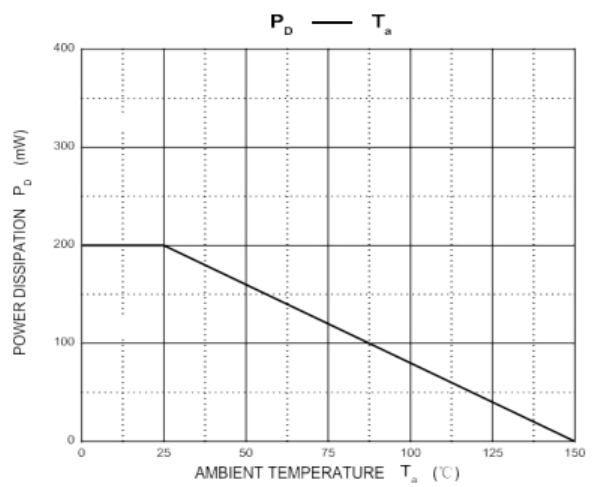
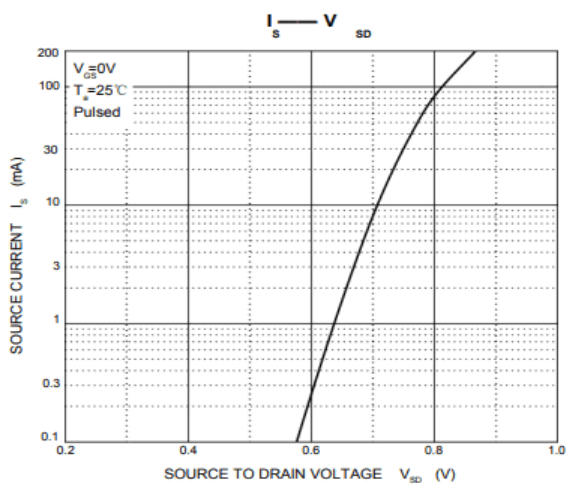
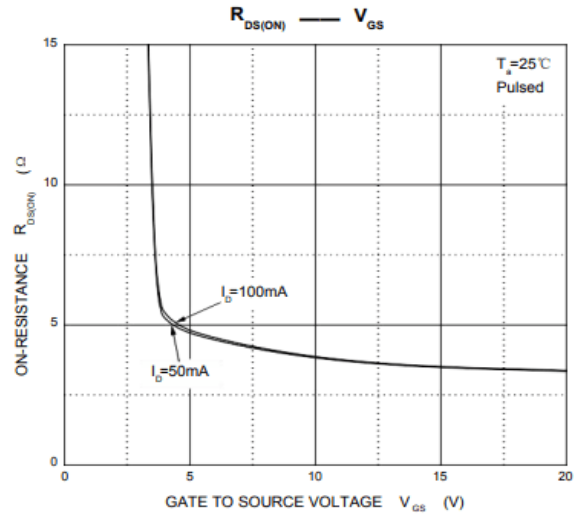
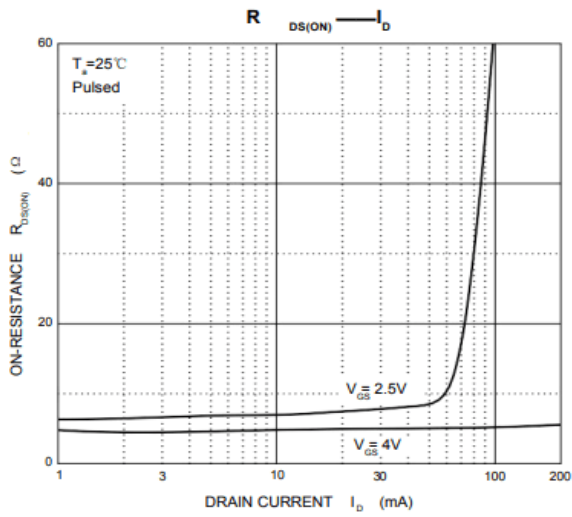
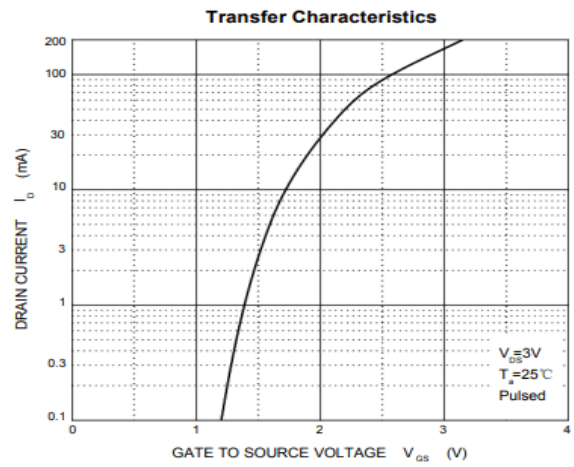
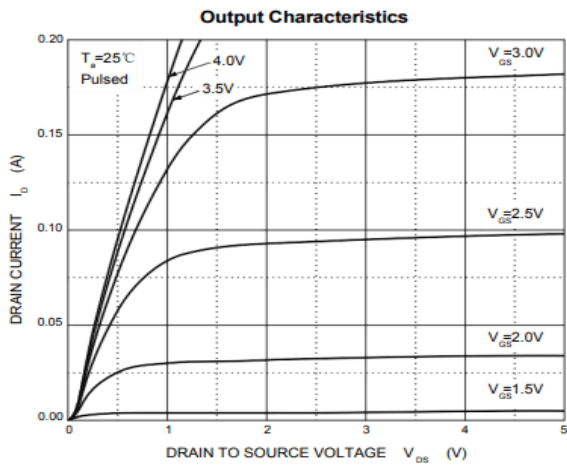

X-ON Electronics

Largest Supplier of Electrical and Electronic Components

Click to view similar products for [MOSFET](#) category:

Click to view products by [Yongyutai Electronics](#) manufacturer:

Other Similar products are found below :

[IRFD120](#) [JANTX2N5237](#) [2SK2267\(Q\)](#) [BUK455-60A/B](#) [TK100A10N1,S4X\(S](#) [MIC4420CM-TR](#) [VN1206L](#) [NDP4060](#) [SI4482DY](#)
[IRS2092STRPBF-EL](#) [IPS70R2K0CEAKMA1](#) [TK31J60W5,S1VQ\(O](#) [TK31J60W,S1VQ\(O](#) [TK16J60W,S1VQ\(O](#) [2SK2614\(TE16L1,Q\)](#)
[DMN1017UCP3-7](#) [EFC2J004NUZTDG](#) [P85W28HP2F-7071](#) [NTE2384](#) [DMC2700UDMQ-7](#) [DMN2080UCB4-7](#) [DMN61D9UWQ-13](#)
[US6M2GTR](#) [DMN31D5UDJ-7](#) [DMP22D4UFO-7B](#) [IPS60R3K4CEAKMA1](#) [DMN1006UCA6-7](#) [DMN16M9UCA6-7](#) [STF5N65M6](#)
[IRF40H233XTMA1](#) [STU5N65M6](#) [DMN6022SSD-13](#) [DMN13M9UCA6-7](#) [DMTH10H4M6SPS-13](#) [IPS60R360PFD7SAKMA1](#)
[DMN2990UFB-7B](#) [SSM3K35CT,L3F](#) [IPLK60R1K0PFD7ATMA1](#) [2N7002W-G](#) [MCAC30N06Y-TP](#) [IPWS65R035CFD7AXKSA1](#)
[MCQ7328-TP](#) [SSM3J143TU,LXHF](#) [DMN12M3UCA6-7](#) [PJMF280N65E1_T0_00201](#) [PJMF380N65E1_T0_00201](#)
[PJMF280N60E1_T0_00201](#) [PJMF600N65E1_T0_00201](#) [PJMF900N65E1_T0_00201](#) [PJMF900N60E1_T0_00201](#)