

# BAW56/BAV70/BAV99

## BAW56/BAV70/BAV99 SWITCHING DIODE

### FEATURES

- Fast Switching Speed
- For General Purpose Switching Applications
- High Conductance

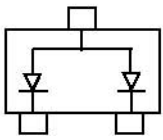
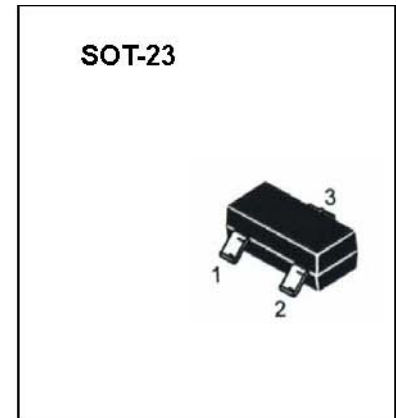

BAW56 Marking: A1

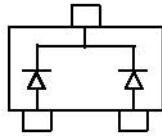

BAV70 Marking: A4

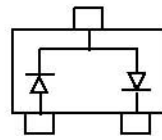

BAV99 Marking: A7

### Maximum Ratings @TA=25°C

Parameter	Symbol	Limits	Unit
Reverse voltage	$V_R$	70	V
Forward Current	$I_F$	200	mA
Peak Forward Surge Current	$I_{FM(surge)}$	500	mA
Power Dissipation	$P_D$	225	mW
Thermal Resistance Junction to Ambient Air	$R_{\theta JA}$	556	°C/W
Junction temperature	$T_J$	150	°C
Storage temperature range	$T_{STG}$	-55-150	°C

### Electrical Characteristics @TA=25°C

Parameter	Symbol	Min.	Typ.	Max.	Unit	Conditions
Reverse Breakdown Voltage	$V_R$	70			V	$I_R=100\mu A$
Forward voltage	$V_{F1}$			0.715	V	$I_F=1mA$
	$V_{F2}$			0.855	V	$I_F=10mA$
	$V_{F3}$			1	V	$I_F=50mA$
	$V_{F4}$			1.25	V	$I_F=150mA$
Reverse current	$I_R$			2.5	$\mu A$	$V_R=70V$
Capacitance between terminals	$C_T$			1.5	pF	$V_R=0, f=1MHz$
Reverse recovery time	$t_{rr}$			6	ns	$I_F = I_R = 10mA, I_{rr} = 0.1 \times I_R, R_L = 100\Omega$

## Typical Characteristics

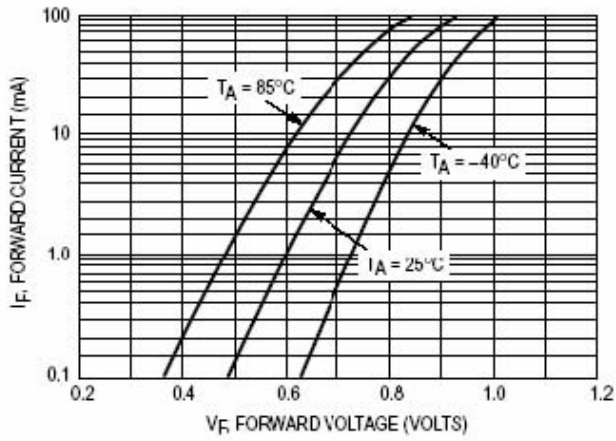

Figure 1. Forward Voltage

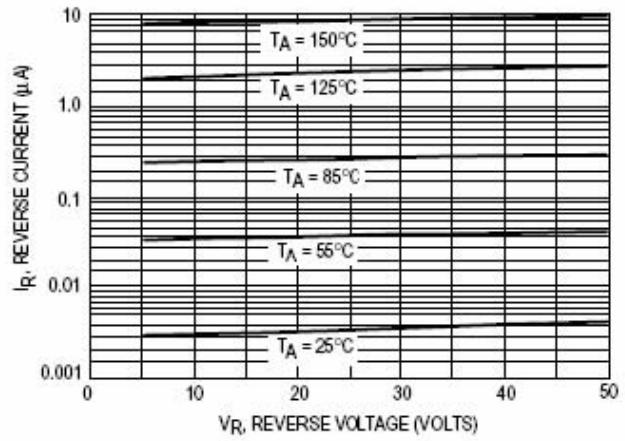

Figure 2. Leakage Current

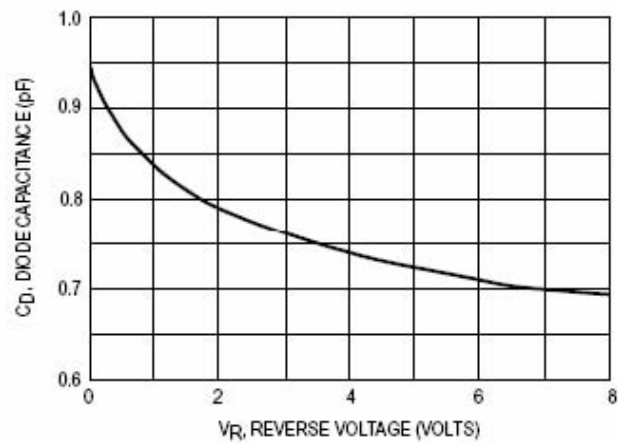

Figure 3. Capacitance

## X-ON Electronics

Largest Supplier of Electrical and Electronic Components

*Click to view similar products for* [Diodes - General Purpose, Power, Switching category:](#)

*Click to view products by* [Yongyutai Electronics manufacturer:](#)

Other Similar products are found below :

[MCL4151-TR3](#) [MMBD3004S-13-F](#) [RD0306T-H](#) [BAV17-TR](#) [BAV19-TR](#) [1N3611](#) [NTE156A](#) [NTE574](#) [NTE6244](#) [1SS181-TP](#)  
[1SS400CST2RA](#) [SDAA13](#) [SHN2D02FUTW1T1G](#) [LS4151GS08](#) [1N4449](#) [1N456A](#) [1N4934-E3/73](#) [1N914B](#) [1N914BTR](#) [1SS226-TP](#)  
[RFUH20TB3S](#) [D291S45T](#) [BAV300-TR](#) [BAW56DWQ-7-F](#) [BAW75-TAP](#) [MM230L-CAA](#) [IDW40E65D1](#) [JAN1N3600](#) [JAN1N4153-1](#)  
[JAN1N4454-1](#) [JAN1N4454UR-1](#) [LL4151-GS18](#) [053684A](#) [SMMSD4148T3G](#) [707803H](#) [NSVDAN222T1G](#) [CDSZC01100-HF](#) [LL4150-M-08](#)  
[1N4454-TR](#) [BAV199E6433HTMA1](#) [BAV70HDW-7](#) [BAS28-7](#) [JANTX1N6640](#) [BAW56HDW-13](#) [BAS28 TR](#) [VS-HFA04SD60STR-M3](#)  
[NSVM1MA152WKT1G](#) [1SS388-TP](#) [RGP30D-E3/73](#) [VS-8EWF02S-M3](#)