

SCHOTTKY BARRIER DIODE

FEATURE

- Small surface mounting type
- Low reverse current and low forward voltage
- High reliability

APPLICATION

- High speed switching for detection
- For portable equipment:(i.e. Mobile phone,MP3, MD,CD-ROM, DVD-ROM, Note book PC, etc.)

MARKING

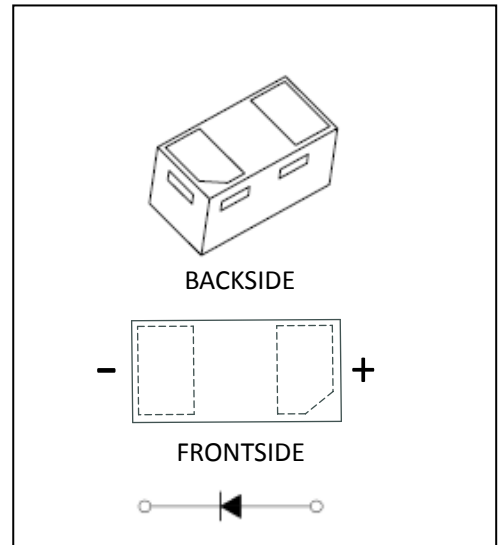

MAXIMUM RATINGS ($T_a=25^{\circ}\text{C}$ unless otherwise noted)

Symbol	Parameter	Limit	Unit
V_{RRM}	Repetitive Peak Reverse Voltage	30	V
V_{RWM}	Working Peak Reverse Voltage		
$V_{R(RMS)}$	RMS Reverse Voltage	21	V
I_o	Average Rectified Output Current	100	mA
I_{FSM}	Non-Repetitive Peak Forward Surge Current@ t=8.3ms	0.5	A
P_d	Power Dissipation	100	mW
$R_{\theta JA}$	Thermal Resistance from Junction to Ambient	1000	$^{\circ}\text{C}/\text{W}$
T_J	Operating Junction Temperature Range	-40 ~ +125	$^{\circ}\text{C}$
T_{stg}	Storage Temperature Range	-55 ~ +150	$^{\circ}\text{C}$

ELECTRICAL CHARACTERISTICS ($T_a = 25^{\circ}\text{C}$ unless otherwise specified)

Parameter	Symbol	Test Condition	Min	Typ	Max	Unit
Reverse breakdown voltage	$V_{(BR)}$	$I_R=50\mu\text{A}$	30			V
Reverse current	I_R	$V_R=10\text{V}$			10	μA
		$V_R=30\text{V}$			50	μA
Forward voltage	V_F	$I_F=10\text{mA}$			0.38	V
		$I_F=100\text{mA}$			0.60	V

Typical Characteristics

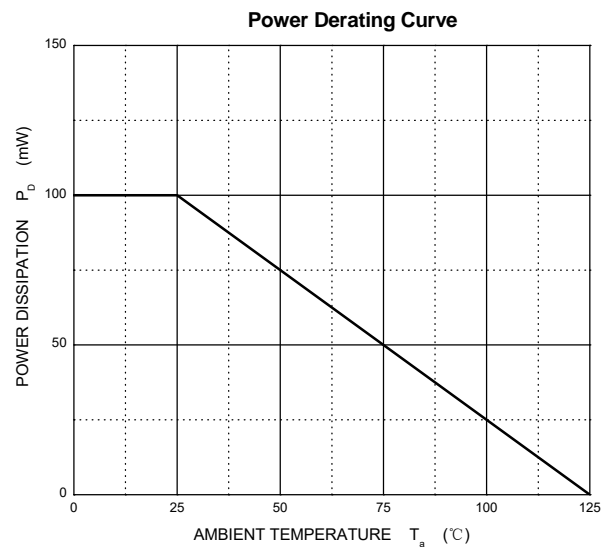
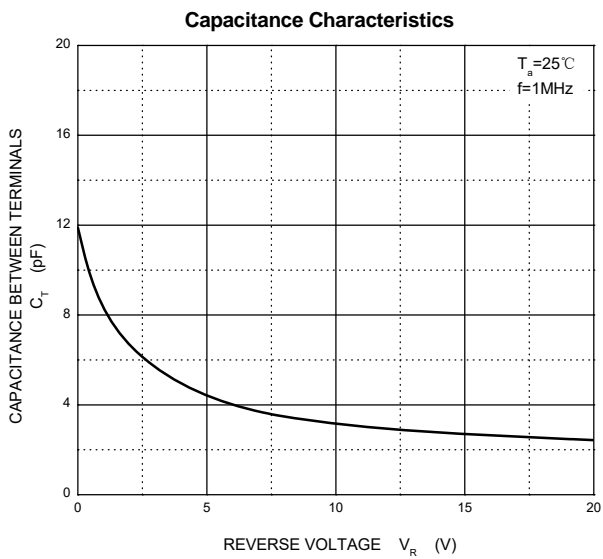
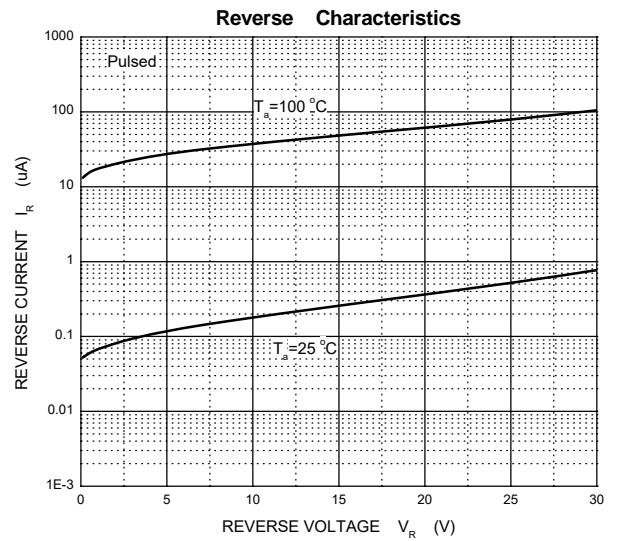
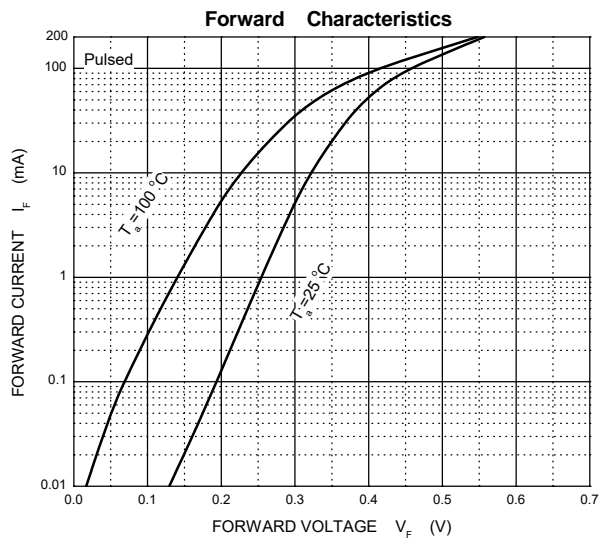

DFN0603 Package Outline Dimensions

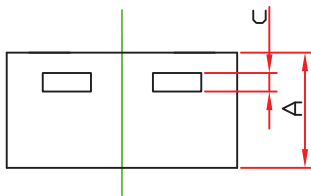
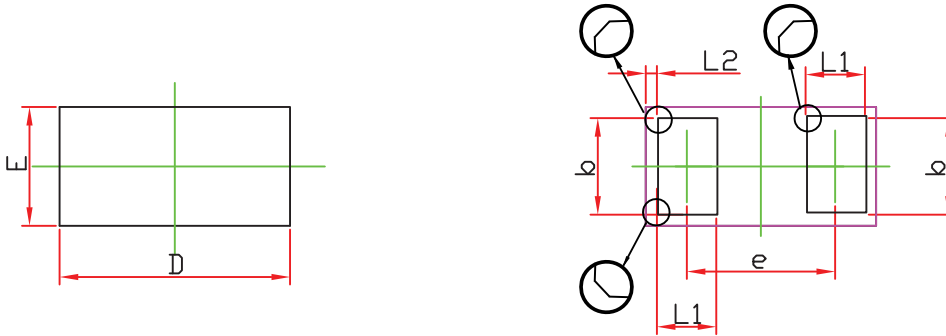

Symbol	Dimensions In Millimeters		Dimensions In Inches	
	Min.	Max.	Min.	Max.
A	0.270	0.340	0.010	0.013
D	0.550	0.670	0.021	0.026
E	0.250	0.370	0.009	0.015
b	0.200	0.350	0.008	0.014
c	0.050 REF.		0.002 REF.	
e	0.350	0.435	0.014	0.017
L1	0.125	0.230	0.005	0.009
L2	0.030 REF.		0.001 REF.	

Suggested Pad Layout

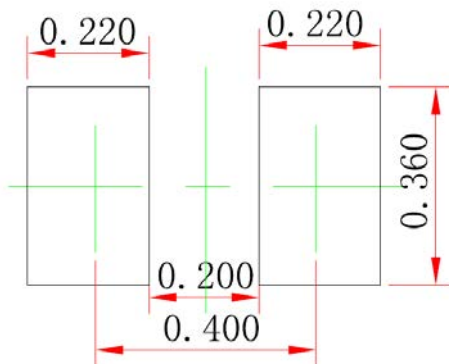

Note:

1. Controlling dimension: in millimeters.
2. General tolerance: ± 0.050 mm.
3. The pad layout is for reference purposes only.

X-ON Electronics

Largest Supplier of Electrical and Electronic Components

Click to view similar products for [Schottky Diodes & Rectifiers](#) category:

Click to view products by [Yongyutai Electronics](#) manufacturer:

Other Similar products are found below :

[MA4E2039](#) [MA4E2508M-1112](#) [MBR10100CT-BP](#) [MBR1545CT](#) [MMBD301M3T5G](#) [RB160M-50TR](#) [BAS16E6433HTMA1](#) [BAS 3010S-02LRH E6327](#) [BAT 54-02LRH E6327](#) [IDL02G65C5XUMA1](#) [NSR05F40QNXT5G](#) [NSVR05F40NXT5G](#) [NTE555](#) [JANS1N6640](#) [SB07-03C-TB-H](#) [SK310-T](#) [SK33A-TP](#) [SK34B-TP](#) [SS3003CH-TL-E](#) [PDS3100Q-7](#) [GA01SHT18](#) [CRS10I30A\(TE85L,QM](#) [MA4E2501L-1290](#) [MBRB30H30CT-1G](#) [JANTX1N5712-1](#) [SB007-03C-TB-E](#) [SK33B-TP](#) [SK35A-TP](#) [SK38B-LTP](#) [NTE505](#) [NTSB30U100CT-1G](#) [VS-6CWQ10FNHM3](#) [CRG04\(T5L,TEMQ\)](#) [ACDBA1100LR-HF](#) [ACDBA1200-HF](#) [ACDBA240-HF](#) [ACDBA3100-HF](#) [CDBQC0530L-HF](#) [ACDBA260LR-HF](#) [ACDBA1100-HF](#) [MA4E2502L-1246](#) [10BQ015-M3/5BT](#) [10BQ060-M3/5BT](#) [NRVB130LSFT1G](#) [CRS08TE85LQM](#) [PMAD1108-LF](#) [B120Q-13-F](#) [1N5819T-G](#) [B0530WSQ-7-F](#) [PDS1040Q-13](#)