

SOT-23 Plastic-Encapsulate MOSFETS
N-Channel 20-V(D-S) MOSFET

V(BR)DSS	RDS(on)MAX	ID
20 V	25mΩ@4.5V	6A
	35mΩ@2.5V	

FEATURE

- ※ TrenchFET Power MOSFET

APPLICATION

- ※ Load Switch for Portable Devices
- ※ DC/DC Converter

MARKING

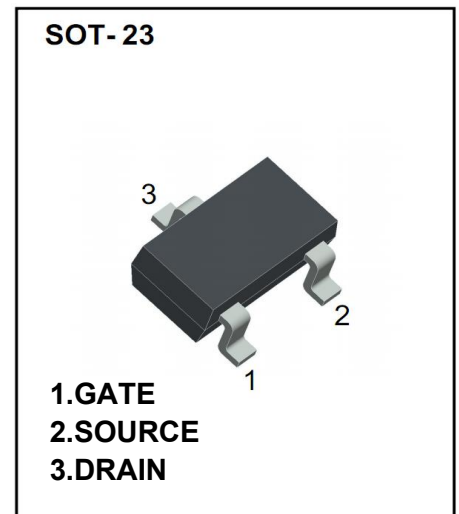
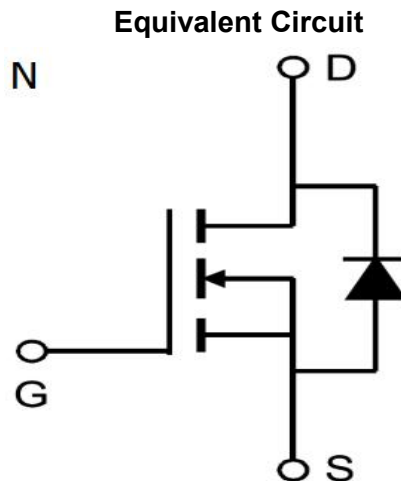
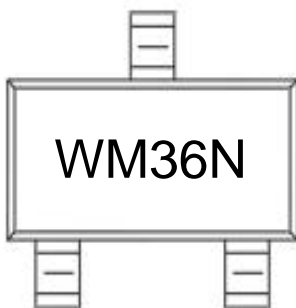

Maximum ratings (Ta=25°C unless otherwise noted)

Parameter	Symbol	Value	Unit
Drain-Source Voltage	VDS	20	V
Gate-Source Voltage	VGS	±12	
Continuous Drain Current	ID	6	A
Continuous Source-Drain Current(Diode Conduction)	IS	0.6	
Power Dissipation	PD	1.25	W
Thermal Resistance from Junction to Ambient (t≤5s)	RθJA	150	°C/W
Operating Junction	TJ	150	°C
Storage Temperature	TSTG	-55~+150	°C

Static Electrical Characteristics (Ta = 25 °C Unless Otherwise Noted)

Parameter	Symbol	Test Condition	Min	Typ	Max	Unit
Static						
Drain-source breakdown voltage	V(BR)DSS	VGS = 0V, ID =250μA	20			V
Gate-threshold voltage	VGS(th)	VDS =VGS, ID =250μA	0.45		1	V
Gate-body leakage	IGSS	VDS =0V, VGS =±12V			±100	nA
Zero gate voltage drain current	IDSS	VDS =16V, VGS =0V			1	μA
Drain-source on-resistancea	RDS(on)	VGS =4.5V, ID = 6A		22	25	mΩ
		VGS =2.5V, ID =4A		28	35	mΩ
Forward transconductancea	gfs	VDS =5V, ID =6A		8		S
Diode forward voltage	VSD	IS=1A, VGS=0V		0.74	1.28	V
Dynamic						
Total gate charge	Qg	VDS =10V, VGS =4.5V, ID =6A		7.7	10	nC
Gate-source charge	Qgs			0.32		nC
Gate-drain charge	Qgd			2.1		nC
Input capacitance b	Ciss	VDS =10V, VGS =0V, f=1MHz		574		pF
Output capacitance b	Coss			70		pF
Reverse transfer capacitanceb	Crss			60		pF
Switchingb						
Turn-on delay time	td(on)	VDD=10V RL=5.5Ω, ID ≈3.6A, VGEN=4.5V,Rg=6Ω		78.7		ns
Rise time	tr			128		ns
Turn-off delay time	td(off)			453		ns
Fall time	tf			80.9		ns

Note :

1. Repetitive Rating : Pulse width limited by maximum junction temperature.
2. Surface Mounted on FR4 Board, t < 5 sec.
3. Pulse Test : Pulse Width≤300μs, Duty Cycle ≤ 2%.
4. Guaranteed by design, not subject to production testing.

TYPICAL ELECTRICAL AND THERMAL CHARACTERISTICS

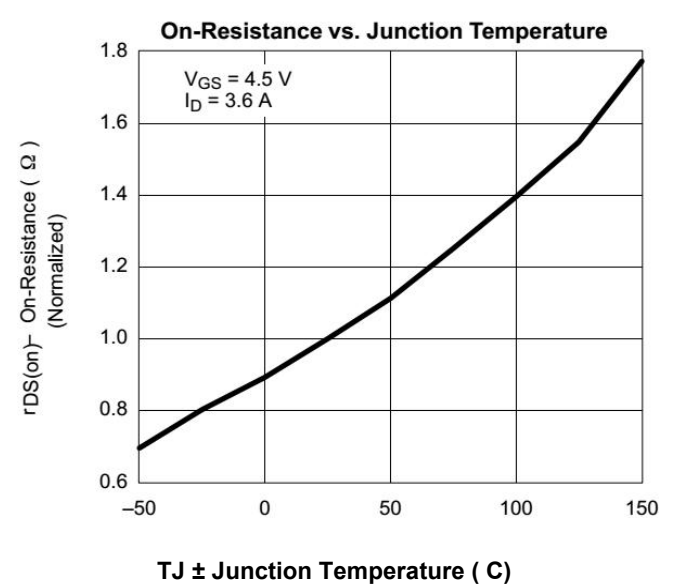
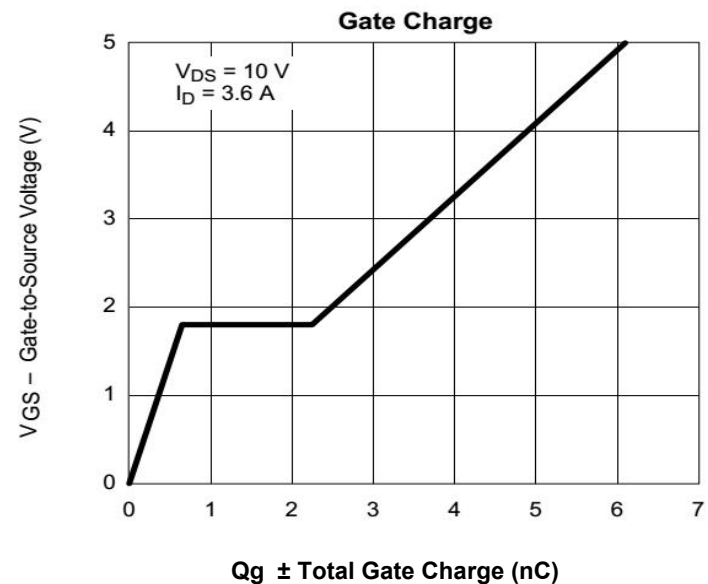
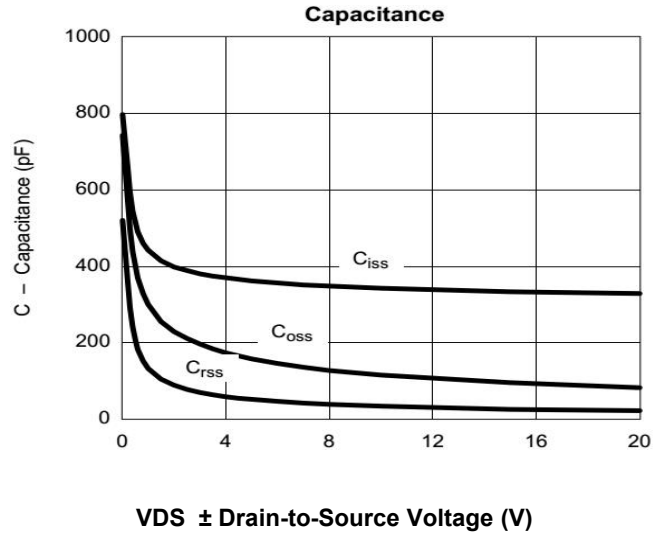
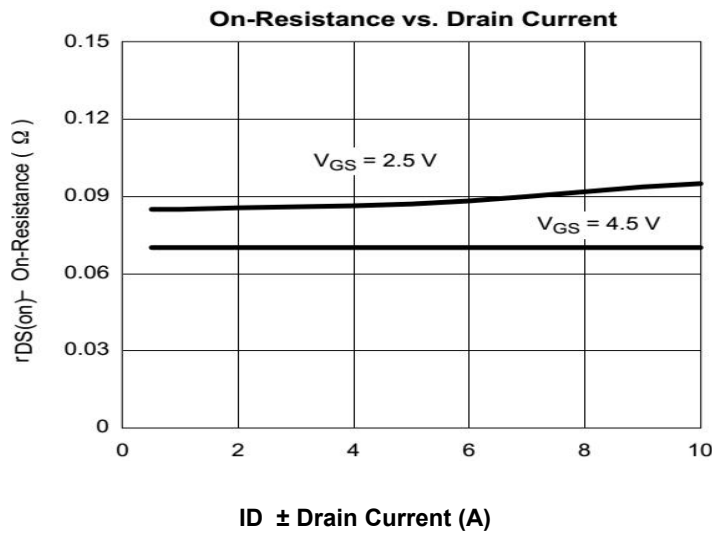
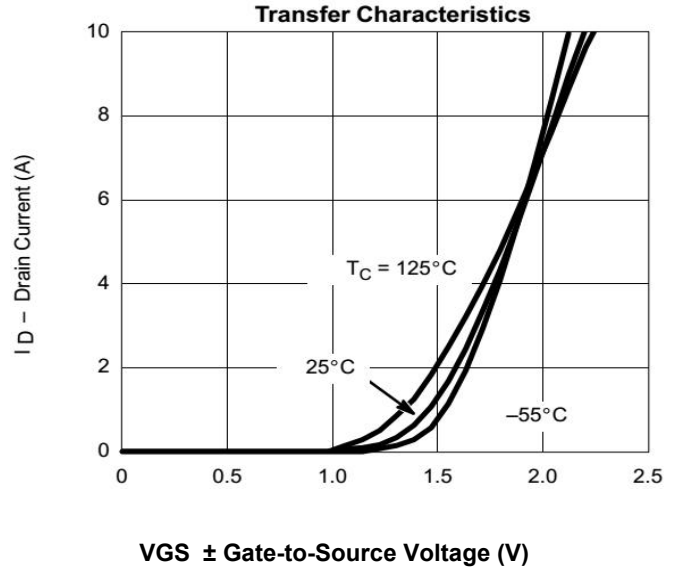
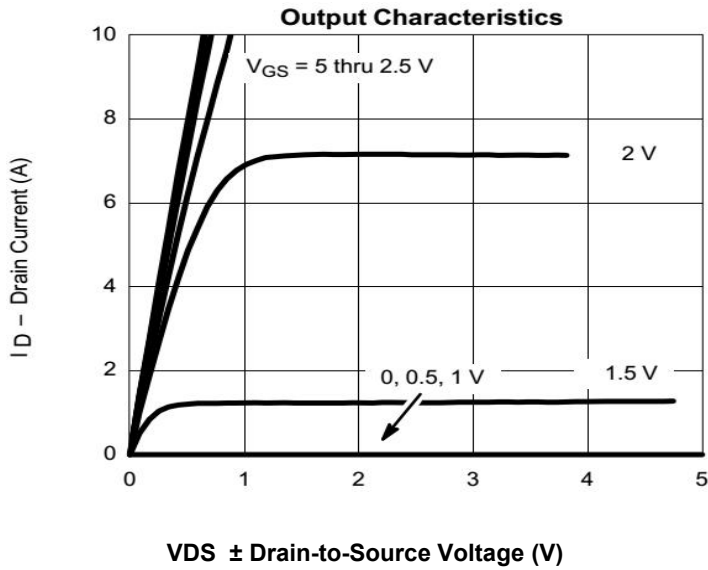

TYPICAL ELECTRICAL AND THERMAL CHARACTERISTICS

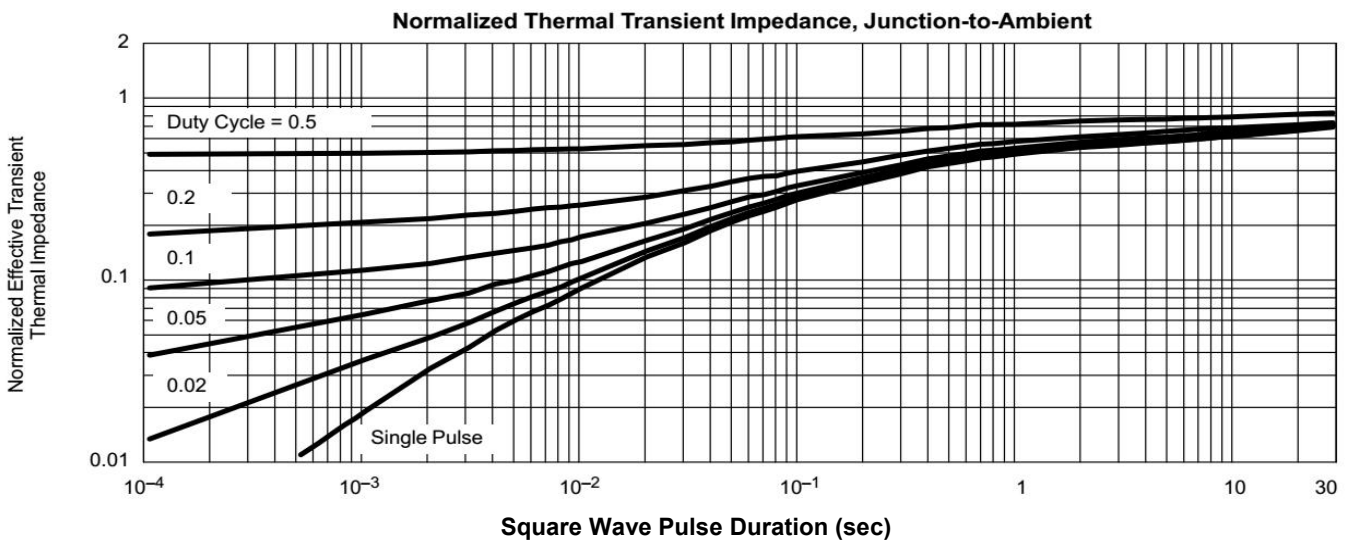
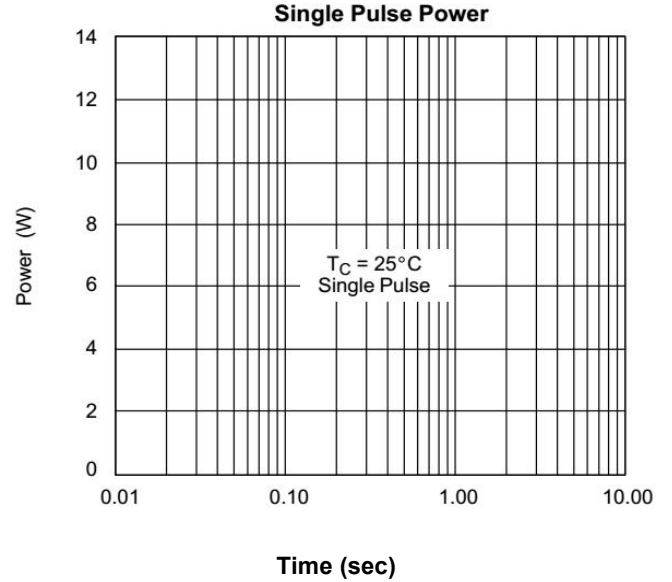
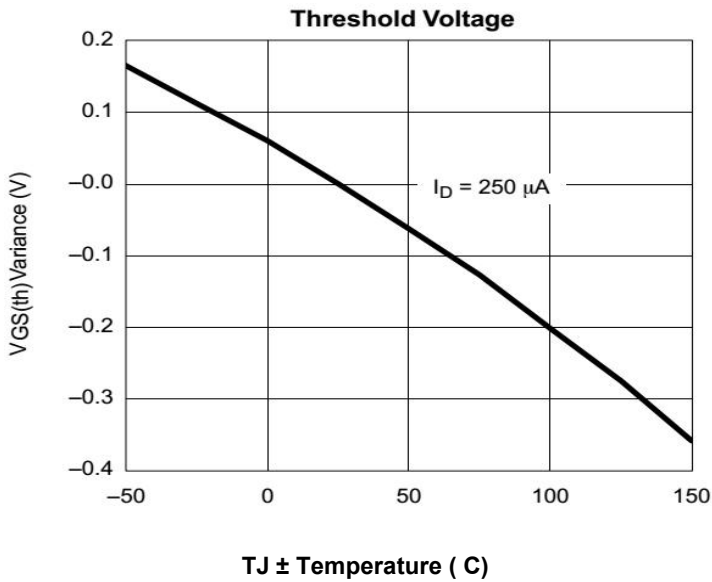
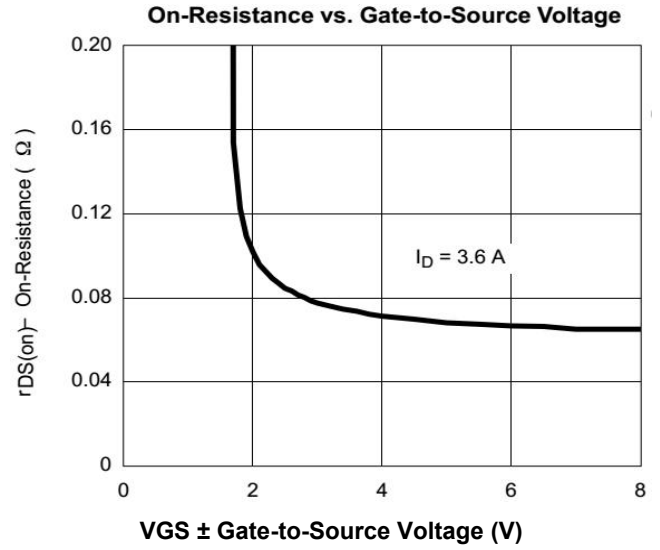
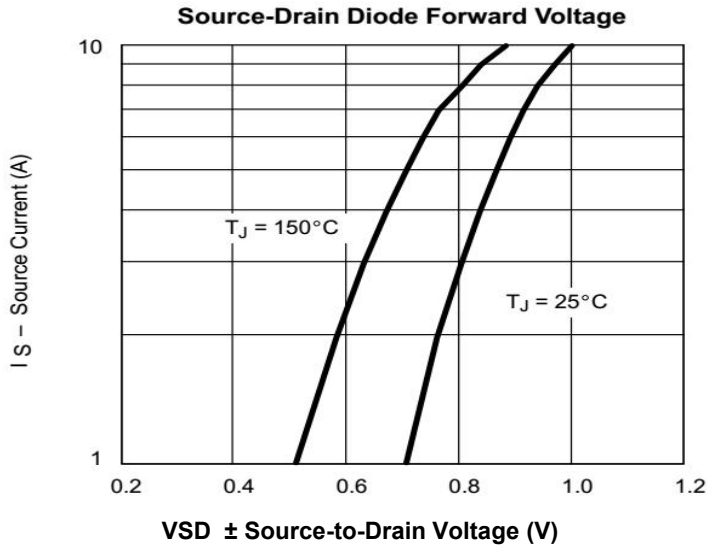

SOT-23 PACKAGE OUTLINE DIMENSIONS

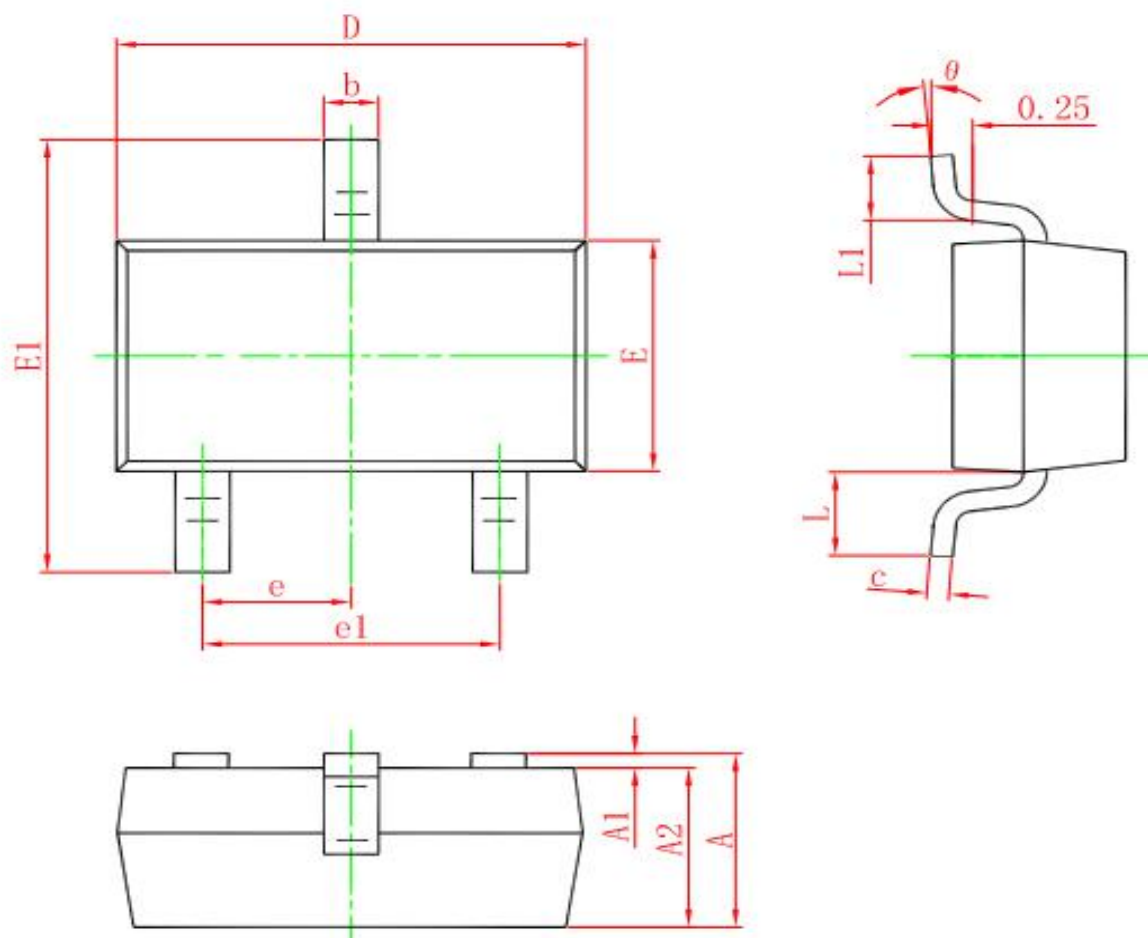

Symbol	Dimensions In Millimeters		Dimensions In Inches	
	Min.	Max.	Min.	Max.
A	0.900	1.150	0.035	0.045
A1	0.000	0.100	0.000	0.004
A2	0.900	1.050	0.035	0.041
b	0.300	0.500	0.012	0.020
c	0.080	0.150	0.003	0.006
D	2.800	3.000	0.110	0.118
E	1.200	1.400	0.047	0.055
E1	2.250	2.550	0.089	0.100
e	0.950 TYP.		0.037 TYP.	
e1	1.800	2.000	0.071	0.079
L	0.550 REF.		0.022 REF.	
L1	0.300	0.500	0.012	0.020
θ	0°	8°	0°	8°

X-ON Electronics

Largest Supplier of Electrical and Electronic Components

Click to view similar products for [MOSFET](#) category:

Click to view products by [Yongyutai Electronics](#) manufacturer:

Other Similar products are found below :

[IRFD120](#) [JANTX2N5237](#) [2SK2267\(Q\)](#) [BUK455-60A/B](#) [TK100A10N1,S4X\(S](#) [MIC4420CM-TR](#) [VN1206L](#) [NDP4060](#) [SI4482DY](#)
[IRS2092STRPBF-EL](#) [IPS70R2K0CEAKMA1](#) [TK31J60W5,S1VQ\(O](#) [TK31J60W,S1VQ\(O](#) [TK16J60W,S1VQ\(O](#) [2SK2614\(TE16L1,Q\)](#)
[DMN1017UCP3-7](#) [EFC2J004NUZTDG](#) [P85W28HP2F-7071](#) [NTE2384](#) [DMC2700UDMQ-7](#) [DMN2080UCB4-7](#) [DMN61D9UWQ-13](#)
[US6M2GTR](#) [DMN31D5UDJ-7](#) [DMP22D4UFO-7B](#) [IPS60R3K4CEAKMA1](#) [DMN1006UCA6-7](#) [DMN16M9UCA6-7](#) [STF5N65M6](#)
[IRF40H233XTMA1](#) [STU5N65M6](#) [DMN6022SSD-13](#) [DMN13M9UCA6-7](#) [DMTH10H4M6SPS-13](#) [IPS60R360PFD7SAKMA1](#)
[DMN2990UFB-7B](#) [SSM3K35CT,L3F](#) [IPLK60R1K0PFD7ATMA1](#) [2N7002W-G](#) [MCAC30N06Y-TP](#) [IPWS65R035CFD7AXKSA1](#)
[MCQ7328-TP](#) [SSM3J143TU,LXHF](#) [DMN12M3UCA6-7](#) [PJMF280N65E1_T0_00201](#) [PJMF380N65E1_T0_00201](#)
[PJMF280N60E1_T0_00201](#) [PJMF600N65E1_T0_00201](#) [PJMF900N65E1_T0_00201](#) [PJMF900N60E1_T0_00201](#)