

DESCRIPTION

The KPESDxxS1BA is designed for applications requiring transient overvoltage protection capability. They are intended for use in voltage and ESD sensitive equipment such as computers, printers, business machines, communication systems, medical equipment and other applications. These devices are ideal for situations where board space is at a premium.

This series has been specifically designed to protect sensitive components which are connected to power, data and transmission lines from overvoltage caused by ESD (electrostatic discharge), CDE (Cable Discharge Events), and EFT (electrical fast transients).

ORDERING INFORMATION

- ✧ Device: KPESDxxS1BA
- ✧ Package: SOD-323
- ✧ Material: Halogen free
- ✧ Packing: Tape & Reel
- ✧ Quantity per reel: 3,000pcs

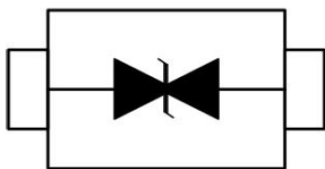
PIN CONFIGURATION**FEATURES**

- ✧ IEC61000-4-2 (ESD) $\pm 15\text{kV}$ (air), $\pm 8\text{kV}$ (contact)
- ✧ IEC61000-4-4 (EFT) 40A (5/50ns)
- ✧ 350 Watts Peak Pulse Power per (tp=8/20 μ s)
- ✧ Protects one I/O line (bidirectional)
- ✧ Low clamping voltage
- ✧ Low leakage current

MACHANICAL DATA

- ✧ SOD-323 package
- ✧ Flammability Rating: UL 94V-0
- ✧ Packaging: Tape and Reel
- ✧ High temperature soldering guaranteed: 260°C/10s
- ✧ Reel size: 7 inch

APPLICATIONS

- ✧ Cell Phone Handsets and Accessories
- ✧ Microprocessor based equipment
- ✧ Personal Digital Assistants (PDA's)
- ✧ Notebooks, Desktops, and Servers
- ✧ Portable Instrumentation
- ✧ Networking and Telecom
- ✧ Serial and Parallel Ports.
- ✧ Peripherals

PACKAGE OUTLINE

ABSOLUTE MAXIMUM RATING

Symbol	Parameter	Value	Units
V_{ESD}	ESD per IEC 61000-4-2 (Air) ESD per IEC 61000-4-2 (Contact)	± 15 ± 8	kV
P_{PP}	Peak Pulse Power (8/20 μ s)	350	W
T_{OPT}	Operating Temperature	-55/+150	$^{\circ}$ C
T_{STG}	Storage Temperature	-55/+150	$^{\circ}$ C
T_L	Lead Soldering Temperature	260 (10 sec.)	$^{\circ}$ C

ELECTRICAL CHARACTERISTICS ($T_{amb}=25^{\circ}$ C)

PART NUMBER	DEVICE MARKING	V_{RWM}	V_B	I_T	$V_C@1A$	V_C		I_R	C_T
		(V) (max.)	(V) (min.)	(mA)	(V) (max.)	(V) (max.)	(@A)	(μ A) (max.)	(pF) (max.)
KPESD3V3S1BA	2A	3.3	4.0	1	7.5	10.5	20	40	450
KPESD5V0S1BA	2B	5.0	6.0	1	9.8	18.0	17	10	200
KPESD12VS1BA	2D	12.0	13.3	1	19.0	32.0	11	1	75
KPESD15VS1BA	2J	15.0	16.7	1	24.0	38.0	10	1	68
KPESD18VS1BA	2K	18.0	20.0	1	29.0	45.0	9	1	57
KPESD24VS1BA	2H	24.0	26.7	1	43.0	52.0	7	1	50
KPESD36VS1BA	2N	36.0	40.0	1	60.0	75.0	5	1	35

ELECTRICAL CHARACTERISTICS CURVE

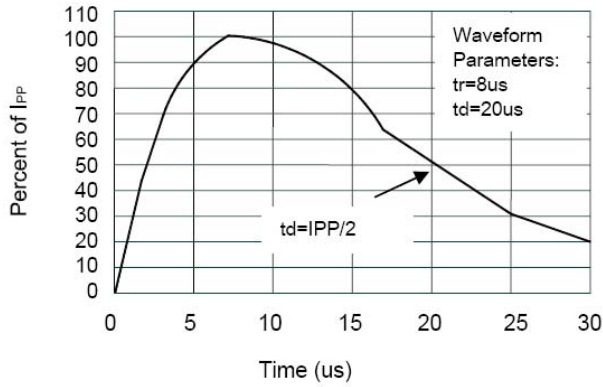

Pulse Waveform

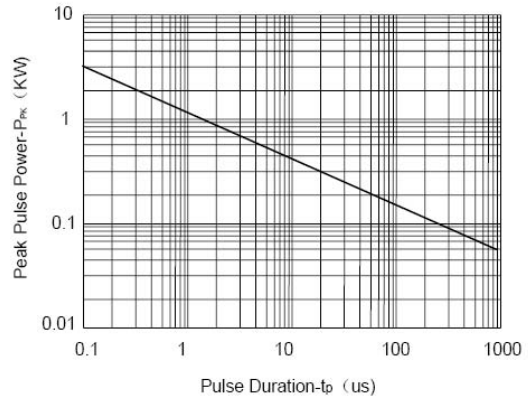

Non-Repetitive Peak Pulse Power vs. Pulse Time

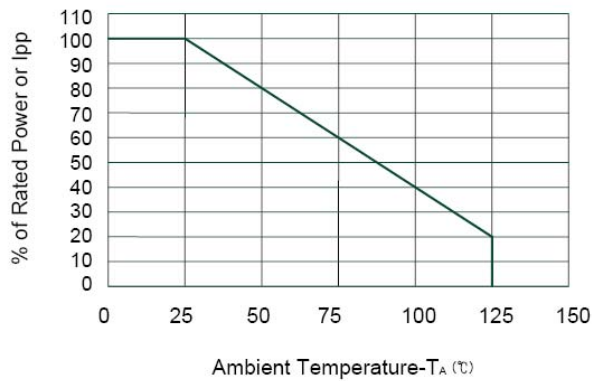

Power Derating Curve

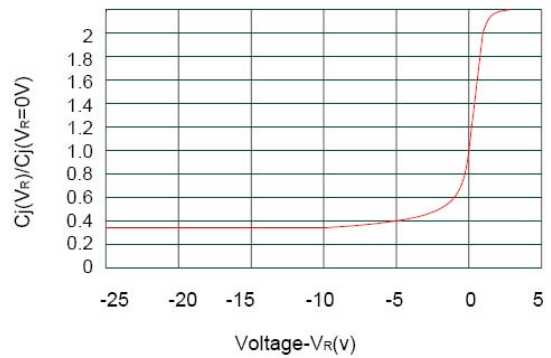

Junction Capacitance vs. Reverse Voltage

SOD-323 PACKAGE OUTLINE DIMENSIONS

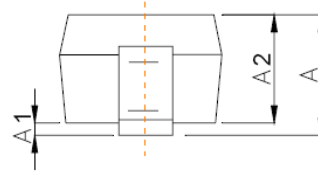
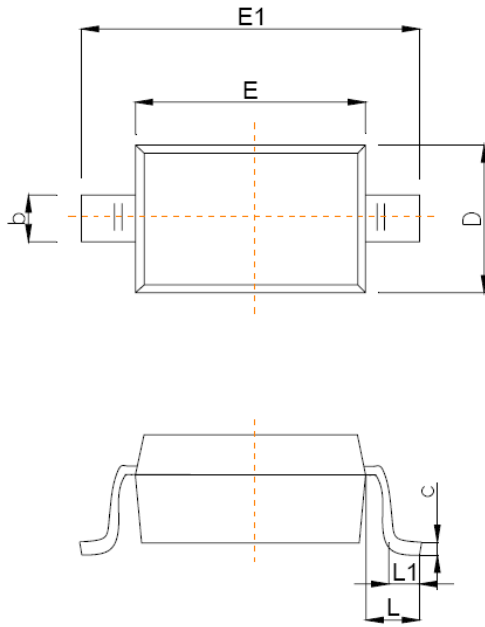

Symbol	Dimensions In Millimeters	
	Min	Max
A		1.00
A1	0.000	0.100
A2	0.800	0.900
b	0.250	0.350
c	0.080	0.150
D	1.200	1.400
E	1.600	1.800
E1	2.500	2.700
e	1.800	2.040
L	0.475 REF	
L1	0.250	0.400
θ	0°	8°

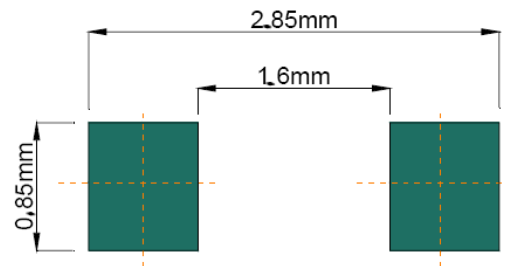

Recommended Pad outline

X-ON Electronics

Largest Supplier of Electrical and Electronic Components

Click to view similar products for [ESD Suppressors / TVS Diodes](#) category:

Click to view products by [Yongyutai Electronics](#) manufacturer:

Other Similar products are found below :

[60KS200C](#) [D18V0L1B2LP-7B](#) [D5V0F4U5P5-7](#) [NTE4902](#) [P4KE27CA](#) [P6KE11CA](#) [P6KE8.2A](#) [SA60CA](#) [SA64CA](#) [SMBJ12CATR](#)
[SMBJ33CATR](#) [SMBJ6.5A](#) [SMBJ8.0A](#) [ESD101-B1-02ELS](#) [E6327](#) [ESD112-B1-02EL](#) [E6327](#) [ESD7451N2T5G](#) [19180-510](#) [CPDT-5V0USP-](#)
[HF](#) [3.0SMCJ33CA-F](#) [3.0SMCJ36A-F](#) [HSPC16701B02TP](#) [JANTX1N6126A](#) [D3V3Q1B2DLP3-7](#) [D55V0M1B2WS-7](#) [SCM1293A-04SO](#)
[ESD200-B1-CSP0201](#) [E6327](#) [SM12-7](#) [CEN955 W/DATA](#) [VESD12A1A-HD1-GS08](#) [CPDQC5V0-HF](#) [D1213A-01LP4-7B](#) [ESD101-B1-02EL](#)
[E6327](#) [AOZ8808DI-03](#) [5KP15A](#) [5KP48A](#) [5KP90A](#) [ESD3V3D7-TP](#) [15KPA36A-LF](#) [P4KE56CA](#) [P4KE68A](#) [P4KE91CATR](#) [P6KE120A](#)
[P6KE13CA](#) [P6KE43CA](#) [P6KE6.8CA](#) [P6KE8.2](#) [P6SMBJ20CA](#) [JANTX1N6072A](#) [SR2835ESKG](#) [SA90CA](#)