

Dual Transient Voltage Suppressors for ESD Protection

Features

- SOT-23 Package
- 2 Unidirectional Transil functions
- Peak Power Dissipation 300W @8 x 20 us Pulse
- Low Leakage
- Fast Response Time < 1 ns
- Protects I/O Port
- ESD Protection to IEC 61000-4-2 Level 4,15KV(Air), 8KV(Contact)
- 16KV Human Body Model ESD Requirements
- RoHS Compliant in Lead-Free Versions

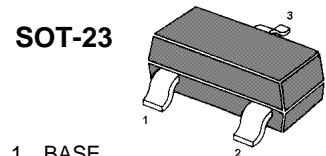

1. BASE
2. EMITTER
3. COLLECTOR

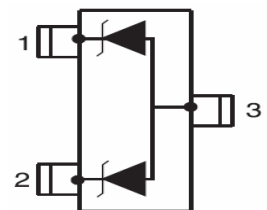

Applications

- Computers
- Printers
- Communication Systems

Absolute Maximum Ratings

Symbol	Parameter	Value	Units
P_{PP}	Peak Pulse Power ($t_p = 8/20\mu s$)	300	W
T_L	Maximum lead temperature for soldering during 10s	260	$^{\circ}C$
T_{stg}	Storage Temperature Range	-55 to +15	$^{\circ}C$
T_{op}	Operating Temperature Range	-40 to +125	$^{\circ}C$
T_j	Maximum junction temperature	150	$^{\circ}C$
V_{PP}	Electrostatic discharge		
	MIL STD 883C -Method 3015-6	25	kv
	IEC61000-4-2 air discharge	16	
IEC61000-4-2 contact discharge	9		

Electrical Characteristics

Symbol	Parameter
V_{RM}	Stand-off voltage
V_{BR}	Breakdown voltage
V_{CL}	Clamping voltage
I_{RM}	Leakage current
I_{PP}	Peak pulse current
αT	Voltage temperature coefficient
V_F	Forward voltage drop
C	Capacitance
R_d	Dynamic resistance

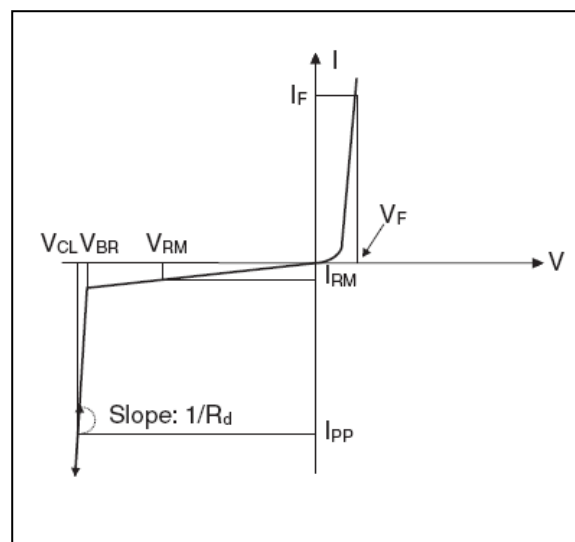

Electrical Characteristics Ratings at 25°C ambient temperature unless otherwise specified.

Part Numbers	Rated Stand-off Voltage	Maximum Leakage Current	Minimum Breakdown Voltage	Maximum Clamping Voltage		Maximum Pulse Peak Current	Maximum Capacitance
		@ V_{RM}	1mA	1A ¹⁾	5A ¹⁾	tp=8/20us	0v, 1MHz
	V_{RM}	I_{RM}	V_{BR}	V_{CL}		I_{PPM}	C
	V	μA	V	V	V	A	pF
KPESD5V2S2UT	5.0	1.0	6.0	9.8	12.5	17	220

Typical Characteristics

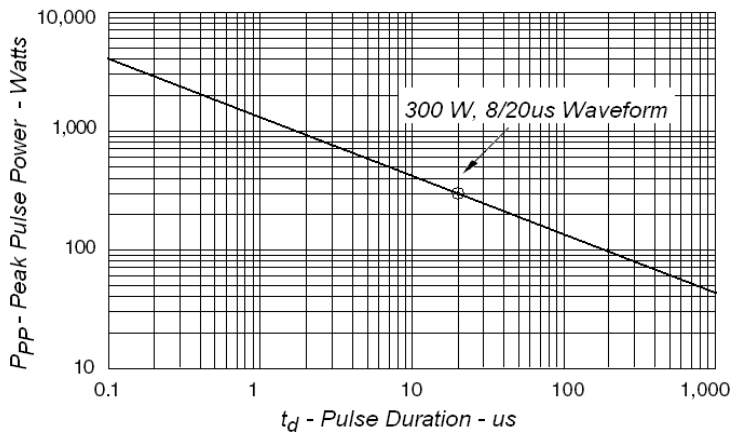

Fig1. Peak Pulse Power VS Pulse Time

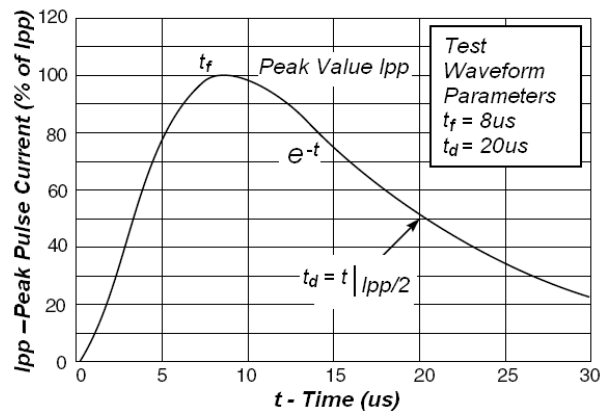

Fig2. Pulse Waveform

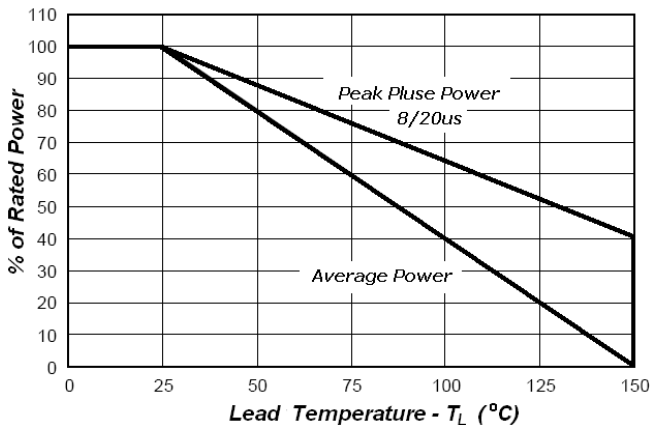
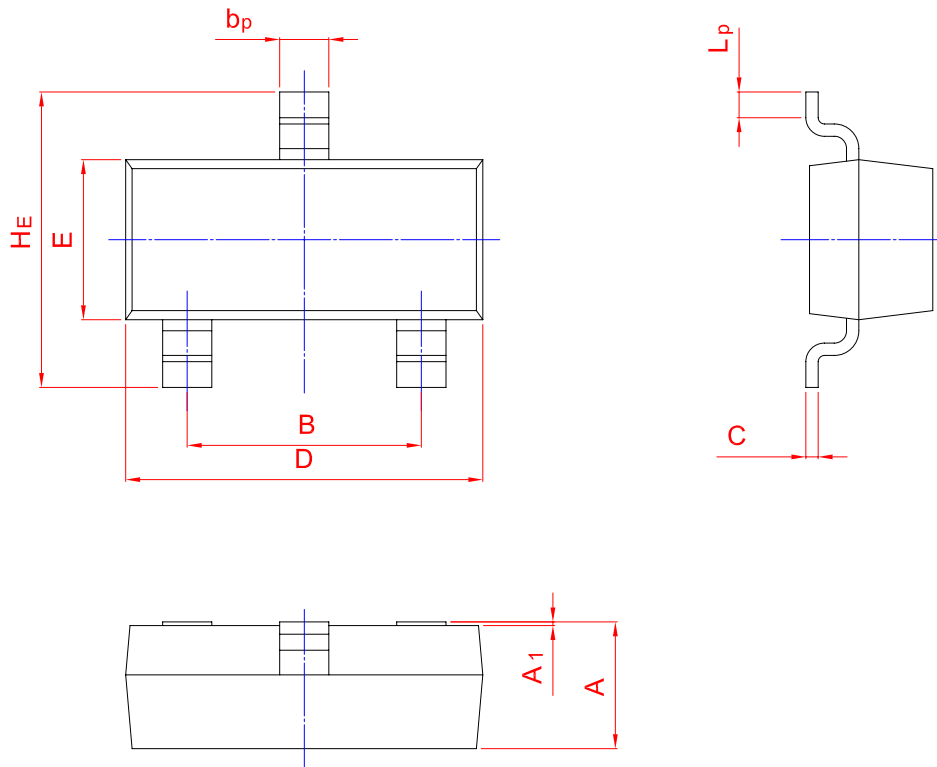

Fig3. Power Derating

PACKAGE OUTLINE

Plastic surface mounted package; 3 leads

SOT-23



UNIT	A	B	b_p	C	D	E	H_E	A_1	L_p
mm	1.40	2.04	0.50	0.19	3.10	1.65	3.00	0.100	0.50
	0.95	1.78	0.35	0.08	2.70	1.20	2.20	0.013	0.20

X-ON Electronics

Largest Supplier of Electrical and Electronic Components

Click to view similar products for [ESD Suppressors / TVS Diodes](#) category:

Click to view products by [Yongyutai Electronics](#) manufacturer:

Other Similar products are found below :

[60KS200C](#) [D18V0L1B2LP-7B](#) [D5V0F4U5P5-7](#) [NTE4902](#) [P4KE27CA](#) [P6KE11CA](#) [P6KE39CA-TP](#) [P6KE8.2A](#) [JANTX1N6053A](#)
[SA110CA](#) [SA60CA](#) [SA64CA](#) [SMBJ12CATR](#) [SMBJ33CATR](#) [SMBJ8.0A](#) [ESD101-B1-02ELS E6327](#) [ESD105-B1-02EL E6327](#) [ESD112-B1-02EL E6327](#) [ESD119B1W01005E6327XTSA1](#) [ESD5V0L1B02VH6327XTSA1](#) [ESD7451N2T5G](#) [19180-510](#) [CPDT-5V0USP-HF](#)
[3.0SMCJ33CA-F](#) [3.0SMCJ36A-F](#) [HSPC16701B02TP](#) [JANTX1N6126A](#) [JANTX1N6462](#) [JANTX1N6465](#) [USB50805e3/TR7](#)
[D3V3Q1B2DLP3-7](#) [D55V0M1B2WS-7](#) [DRTR5V0U4SL-7](#) [SCM1293A-04SO](#) [ESD200-B1-CSP0201 E6327](#) [SM12-7](#) [SM1605E3/TR13](#)
[SMLJ45CA-TP](#) [CEN955 W/DATA](#) [82350120560](#) [VESD12A1A-HD1-GS08](#) [CPDUR5V0R-HF](#) [CPDQC5V0U-HF](#) [CPDQC5V0USP-HF](#)
[CPDQC5V0-HF](#) [D1213A-01LP4-7B](#) [ESD101-B1-02EL E6327](#) [824500181](#) [MMAD1108/TR13](#) [5KP100A](#)