

N-Channel 20-V(D-S) MOSFET

V(BR)DSS	RDS(on)MAX	ID
20 V	50mΩ@4.5V	4.2A
	63mΩ@2.5V	
	87mΩ@1.8V	

FEATURE:

※ TrenchFET Power MOSFET

MARKING:

AE9T

Equivalent Circuit :

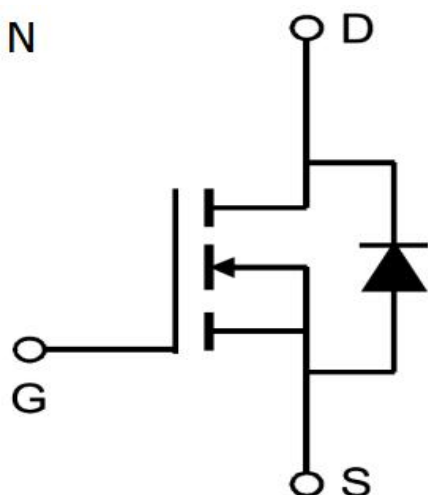

General Description :

The uses advanced trench technology to provide excellent RDS(ON), low gate charge and operation with gate voltages as low as 1.8V. This device is suitable for use as a load switch or inPWM applications. Standard Product MK3414 is Pb-free (meets ROHS & Sony 259 specifications).

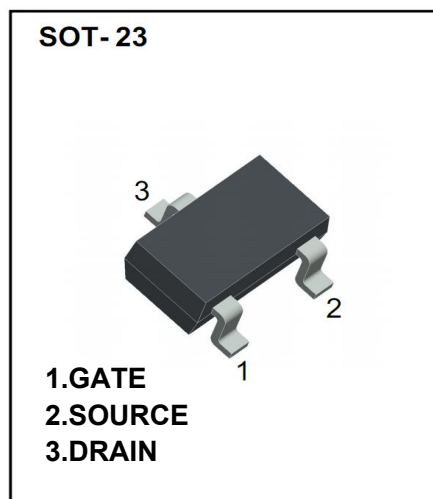

Maximum ratings (Ta=25°C unless otherwise noted)

Parameter	Symbol	Value	Unit
Drain-Source Voltage	VDS	20	V
Gate-Source Voltage	VGS	±8	
Continuous Drain Current	ID	4.2	A
Pulsed Diode Curren	IDM	15	
Continuous Source-Drain Current(Diode Conduction)	IS	2	
Power Dissipation	PD	1.4	W
Thermal Resistance from Junction to Ambient (t≤10s)	RθJA	125	°C/W
Operating Junction	TJ	150	°C
Storage Temperature	TSTG	-55~+150	°C

MOSFET ELECTRICAL CHARACTERISTICS

Static Electrical Characteristics (Ta = 25 °C Unless Otherwise Noted)

Parameter	Symbol	Test Condition	Min	Typ	Max	Unit
Static						
Drain-source breakdown voltage	V(BR)DSS	VGS = 0V, ID = 250μA	20			V
Gate-source threshold voltage	VGS(th)	VDS = VGS, ID = 250μA	0.4		1.4	V
Gate-body leakage current	IGSS	VDS = 0V, VGS = ±8V			±100	nA
Zero gate voltage drain current	IDSS	VDS = 20V, VGS = 0V			1	μA
Static Drain-Source On-Resistance	RDS(on)	VGS = 4.5V, ID = 4.2A		41	50	mΩ
		VGS = 2.5V, ID = 3.6A		52	63	mΩ
		VGS = 1.8V, ID = 3A		67	87	mΩ
Forward transconductance	gfs	VDS = 5V, ID = 4.2A		11		S
Diode forward voltage	VSD	IS = 1A, VGS = 0V		0.8	1	V
Maximum Body-Diode Continuous Current	IS				2	A
Dynamic						
Input capacitance	Ciss	VDS = 10V, VGS = 0V, f = 1MHz		436		pF
Output capacitance	Coss			66		pF
Reverse transfer capacitance	Crss			44		pF
Total gate charge	Qg	VDS = 10V, VGS = 4.5V, ID = 4.2A		6.2		nC
Gate-source charge	Qgs			1.6		nC
Gate-drain charge	Qgd			0.5		nC
Gate resistance	Rg	f = 1MHz		3		Ω
Switching						
Turn-on delay time	td(on)	VDS = 10V RL = 2.7Ω, ID = 4.2A, VGS = 5V, Rg = 6Ω		5.5		ns
Rise time	tr			6.3		ns
Turn-off delay time	td(off)			40		ns
Fall time	tf			12.7		ns
Body Diode Reverse Recovery Time	Trr	IF = 4A, dI/dt = 100A/μs		12.3		ns
Body Diode Reverse Recovery Charge	Qrr	IF = 4A, dI/dt = 100A/μs		3.5		nC

Note :

1. Repetitive Rating : Pulse width limited by maximum junction temperature.
2. Surface Mounted on FR4 Board, t < 10 sec.
3. Pulse Test : Pulse Width ≤ 300μs, Duty Cycle ≤ 2%.
4. Guaranteed by design, not subject to production testing.

Typical Electrical Thermal Characteristics:

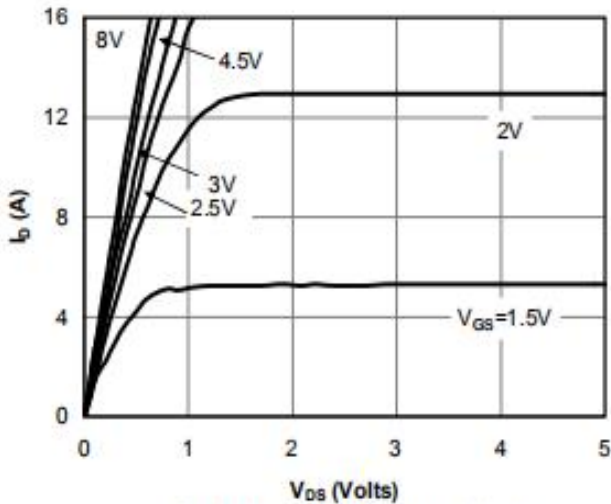

Fig 1: On-Region Characteristics

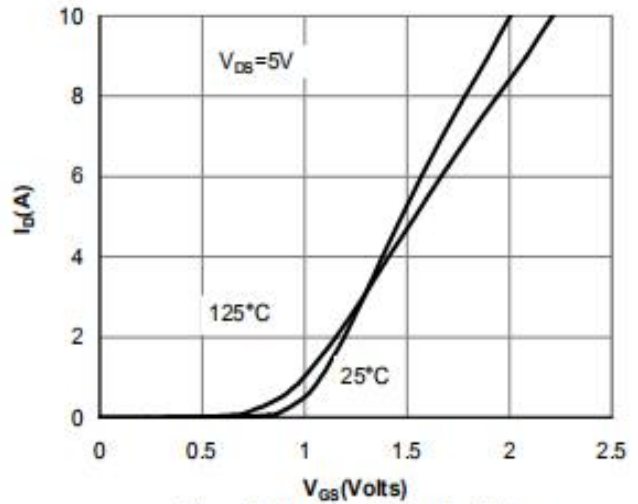

Figure 2: Transfer Characteristics

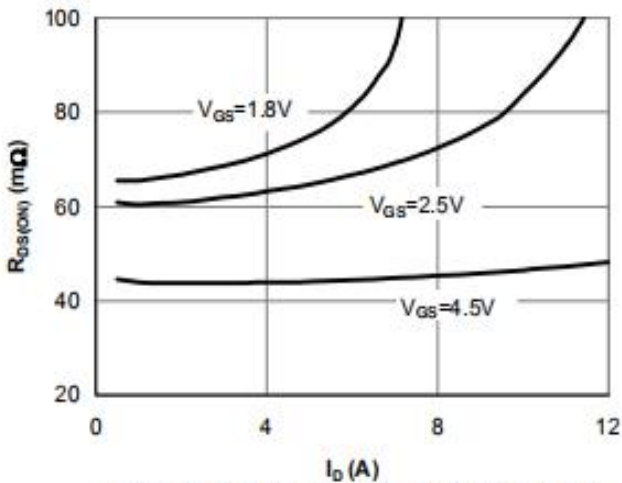

Figure 3: On-Resistance vs. Drain Current and Gate Voltage

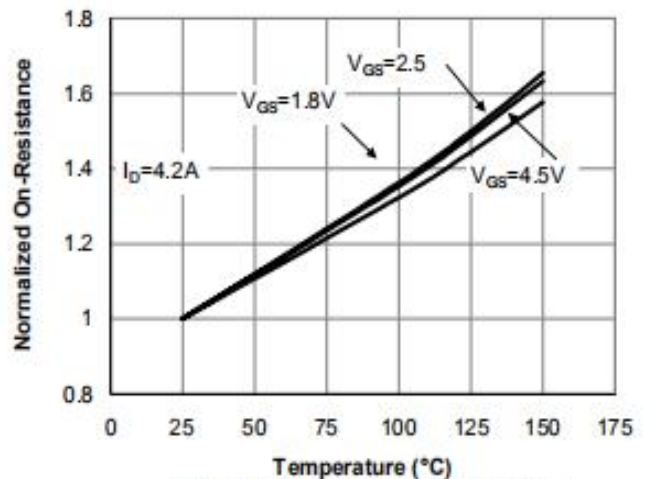

Figure 4: On-Resistance vs. Junction Temperature

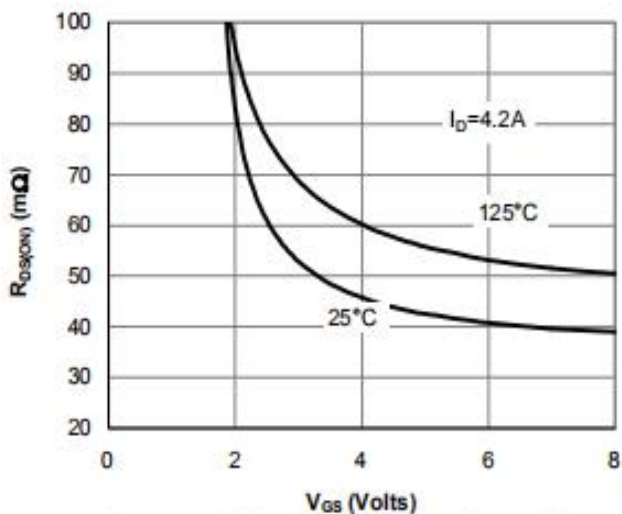

Figure 5: On-Resistance vs. Gate-Source Voltage

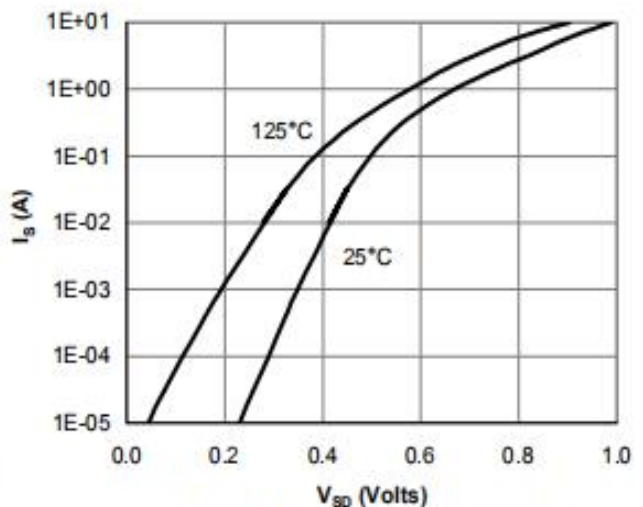

Figure 6: Body-Diode Characteristics

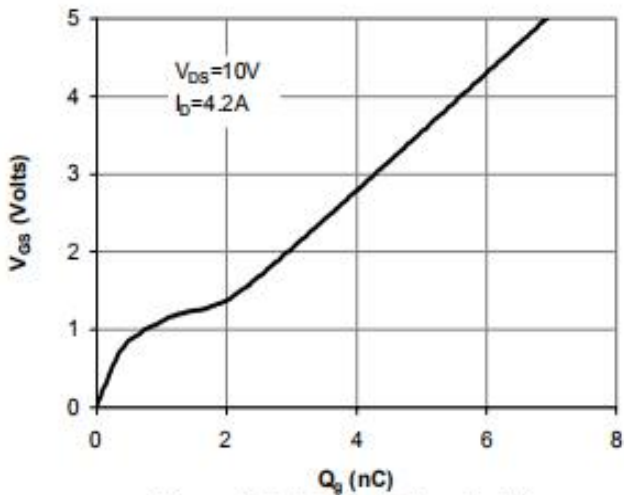

Figure 7: Gate-Charge Characteristics

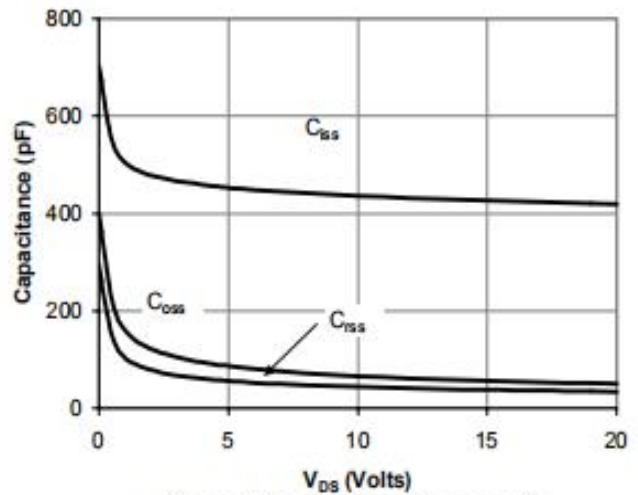

Figure 8: Capacitance Characteristics

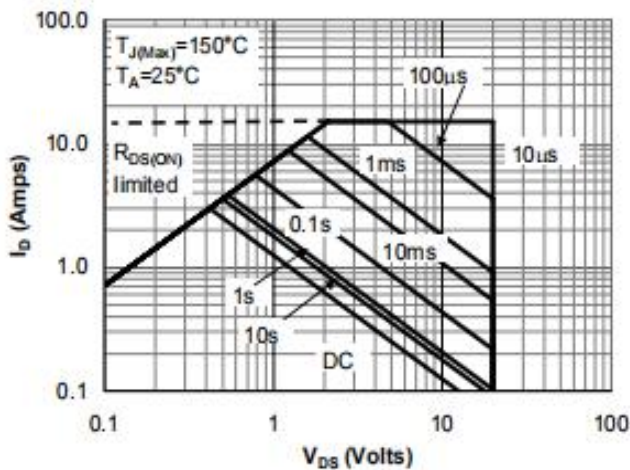

Figure 9: Maximum Forward Biased Safe Operating Area (Note E)

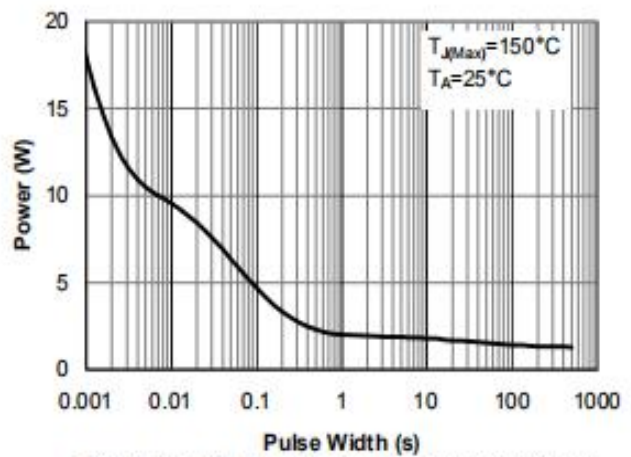

Figure 10: Single Pulse Power Rating Junction-to-Ambient (Note E)

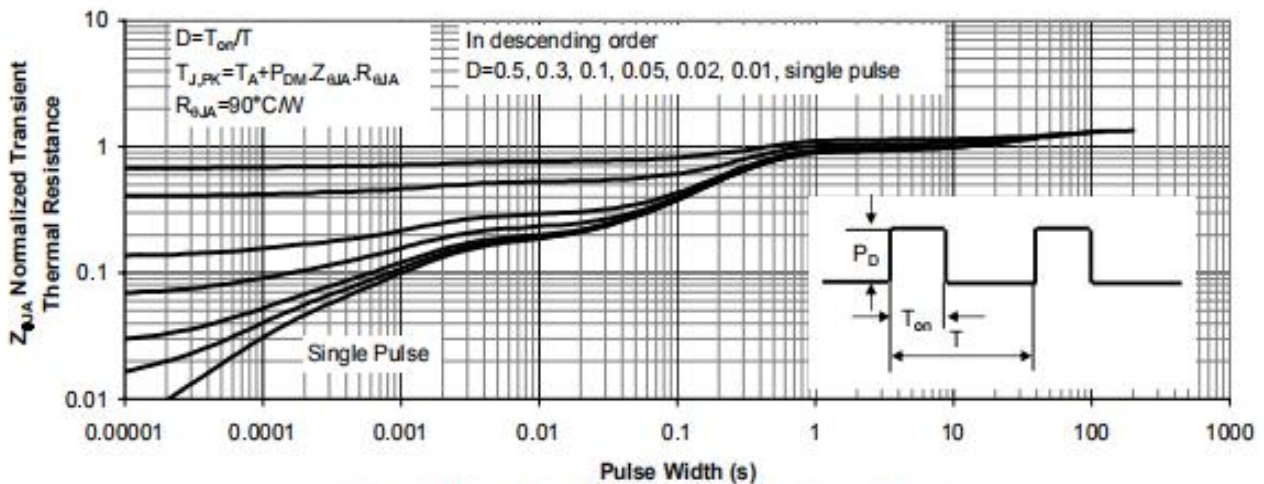
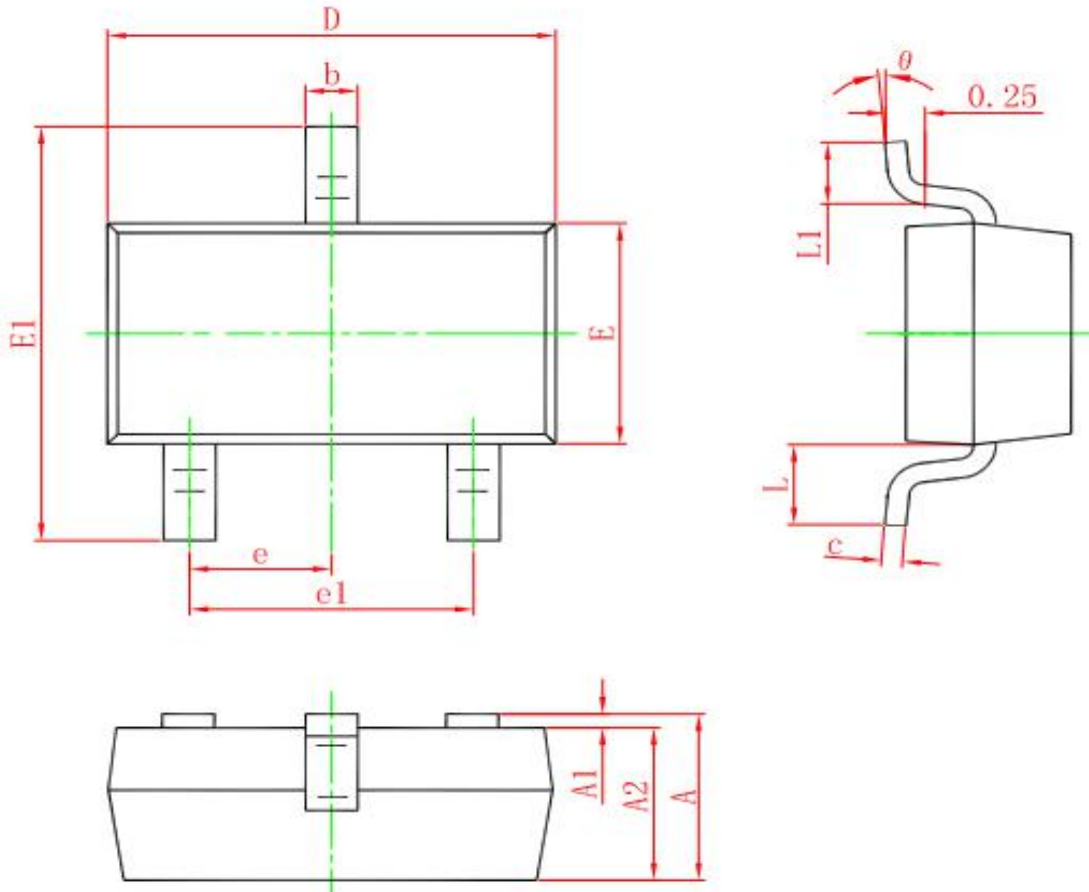

Figure 11: Normalized Maximum Transient Thermal Impedance

SOT-23 PACKAGE OUTLINE DIMENSIONS:

SOT-23 PACKAGE OUTLINE DIMENSIONS



Symbol	Dimensions In Millimeters		Dimensions In Inches	
	Min.	Max.	Min.	Max.
A	0.900	1.150	0.035	0.045
A1	0.000	0.100	0.000	0.004
A2	0.900	1.050	0.035	0.041
b	0.300	0.500	0.012	0.020
c	0.080	0.150	0.003	0.006
D	2.800	3.000	0.110	0.118
E	1.200	1.400	0.047	0.055
E1	2.250	2.550	0.089	0.100
e	0.950 TYP.		0.037 TYP.	
e1	1.800	2.000	0.071	0.079
L	0.550 REF.		0.022 REF.	
L1	0.300	0.500	0.012	0.020
θ	0°	8°	0°	8°

X-ON Electronics

Largest Supplier of Electrical and Electronic Components

Click to view similar products for [MOSFET](#) category:

Click to view products by [Yongyutai Electronics](#) manufacturer:

Other Similar products are found below :

[IRFD120](#) [JANTX2N5237](#) [2SK2267\(Q\)](#) [BUK455-60A/B](#) [TK100A10N1,S4X\(S](#) [MIC4420CM-TR](#) [VN1206L](#) [NDP4060](#) [SI4482DY](#)
[IRS2092STRPBF-EL](#) [IPS70R2K0CEAKMA1](#) [TK31J60W5,S1VQ\(O](#) [TK31J60W,S1VQ\(O](#) [TK16J60W,S1VQ\(O](#) [2SK2614\(TE16L1,Q\)](#)
[DMN1017UCP3-7](#) [EFC2J004NUZTDG](#) [P85W28HP2F-7071](#) [NTE2384](#) [DMC2700UDMQ-7](#) [DMN2080UCB4-7](#) [DMN61D9UWQ-13](#)
[US6M2GTR](#) [DMN31D5UDJ-7](#) [DMP22D4UFO-7B](#) [IPS60R3K4CEAKMA1](#) [DMN1006UCA6-7](#) [DMN16M9UCA6-7](#) [STF5N65M6](#)
[IRF40H233XTMA1](#) [STU5N65M6](#) [DMN6022SSD-13](#) [DMN13M9UCA6-7](#) [DMTH10H4M6SPS-13](#) [IPS60R360PFD7SAKMA1](#)
[DMN2990UFB-7B](#) [SSM3K35CT,L3F](#) [IPLK60R1K0PFD7ATMA1](#) [2N7002W-G](#) [MCAC30N06Y-TP](#) [IPWS65R035CFD7AXKSA1](#)
[MCQ7328-TP](#) [SSM3J143TU,LXHF](#) [DMN12M3UCA6-7](#) [PJMF280N65E1_T0_00201](#) [PJMF380N65E1_T0_00201](#)
[PJMF280N60E1_T0_00201](#) [PJMF600N65E1_T0_00201](#) [PJMF900N65E1_T0_00201](#) [PJMF900N60E1_T0_00201](#)