

Surface mount transient voltage suppressor power 200 watts

Stand-Off Voltage : 5.0V~220V

FEATURES

- For surface mounted applications in order to optimize board space.
- Low profile package
- Glass passivated junction
- Low inductance
- Plastic package has Underwriters Laboratory Flammability

MECHANICAL DATA

- Case: SOD-123FL
- Terminals: Solderable per MIL-STD-750, Method 2026
- Approx. Weight:15mg 0.00048oz

Maximum Ratings and Electrical characteristics

Ratings at 25 °C ambient temperature unless otherwise specified.

Parameter	Symbol	Value	Unit
Peak Pulse Power Dissipation on TA=25°C (Note 1,2,5, Fig1)	P_{PPM}	200	W
Peak Forward Surge Current (Note 3)	I_{FSM} (UNI)	20	A
Peak Pulse Current on 10/1000 us waveform (Note 1) Fig 2	I_{PPM}	see Table 1	A
Steady State Power Dissipation (Note 4)	$P_{M(AV)}$	1	W
Operating Junction and Storage Range	T_J, T_{STG}	-55 to +150	°C
Typical Thermal Resistance	$R_{\theta JA}$	180	°C

NOTES

1. Non-repetitive current pulse per Fig 3 and derated above $T_A=25^\circ\text{C}$ per Fig 2
2. Mounted on 5mm² copper pads to each terminal
3. 8.3ms single half sinewave, or equivalent square wave duty cycle=4 pulses per minutes maximum
4. lead temperature at $T_l=75^\circ\text{C}$
5. Peak pulse powe. waveform is tp=10/1000us
6. A transient suppressor is selected according to the working peak reverse voltage(V_{RWM}), Which Should be equal to or greater than the DC or continuous peak operating voltage level

PINNING

PIN	DESCRIPTION
1	Cathode
2	Anode

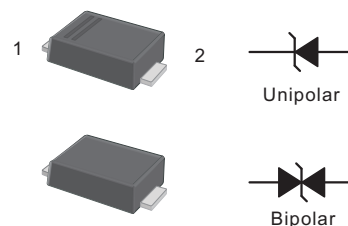

Top View
Simplified outline sSOD-123FL and symbol

Characteristics at Ta = 25°C

Type		Marking		V _{RWM}	Breakdown Voltage		Test Current	Reverse Leakage	Max. Clamp Voltage	Peak Pulse Current
					V _{BR} @ I _T					
Uni	Bi	Uni	Bi	V	Min	Max	I _T	I _R @ V _{RWM}	V _C @ I _{PP}	I _{PP}
				V	V	V	mA	µA	V	A
KSJD12A05L01	KSJD12C05L01	AE	CAE	5	6.4	7	10	200	9.2	21.7
KSJD12A06L01	KSJD12C06L01	AG	CAG	6	6.67	7.37	10	100	10.3	19.4
KSJD12A6.5L01	KSJD12C6.5L01	AK	CAK	6.5	7.22	7.98	10	75	11.2	17.9
KSJD12A07L01	KSJD12C07L01	AM	CAM	7	7.78	8.6	10	50	12	16.7
KSJD12A7.5L01	KSJD12C7.5L01	AP	CAP	7.5	8.33	9.21	1	50	12.9	15.5
KSJD12A08L01	KSJD12C08L01	AR	CAR	8	8.89	9.83	1	25	13.6	14.7
KSJD12A8.5L01	KSJD12C8.5L01	AT	CAT	8.5	9.44	10.4	1	10	14.4	13.9
KSJD12A09L01	KSJD12C09L01	AV	CAV	9	10	11.1	1	5	15.4	13
KSJD12A10L01	KSJD12C10L01	AX	CAX	10	11.1	12.3	1	2.5	17	11.8
KSJD12A11L01	KSJD12C11L01	AZ	CAZ	11	12.2	13.5	1	2.5	18.2	11
KSJD12A12L01	KSJD12C12L01	BE	CBE	12	13.3	14.7	1	2.5	19.9	10.1
KSJD12A13L01	KSJD12C13L01	BG	CBG	13	14.4	15.9	1	1	21.5	9.3
KSJD12A14L01	KSJD12C14L01	BK	CBK	14	15.6	17.2	1	1	23.2	8.6
KSJD12A15L01	KSJD12C15L01	BM	CBM	15	16.7	18.5	1	1	24.4	8.2
KSJD12A16L01	KSJD12C16L01	BP	CBP	16	17.8	19.7	1	1	26	7.7
KSJD12A17L01	KSJD12C17L01	BR	CBR	17	18.9	20.9	1	1	27.6	7.2
KSJD12A18L01	KSJD12C18L01	BT	CBT	18	20	22.1	1	1	29.2	6.8
KSJD12A20L01	KSJD12C20L01	BV	CBV	20	22.2	24.5	1	1	32.4	6.2
KSJD12A22L01	KSJD12C22L01	BX	CBX	22	24.4	26.9	1	1	35.5	5.6
KSJD12A24L01	KSJD12C24L01	BZ	CBZ	24	26.7	29.5	1	1	38.9	5.1
KSJD12A26L01	KSJD12C26L01	CE	CCE	26	28.9	31.9	1	1	42.1	4.8
KSJD12A28L01	KSJD12C28L01	CG	CCG	28	31.1	34.4	1	1	45.4	4.4
KSJD12A30L01	KSJD12C30L01	CK	CCK	30	33.3	36.8	1	1	48.4	4.1
KSJD12A33L01	KSJD12C33L01	CM	CCM	33	36.7	40.6	1	1	53.3	3.8
KSJD12A36L01	KSJD12C36L01	CP	CCP	36	40	44.2	1	1	58.1	3.4
KSJD12A40L01	KSJD12C40L01	CR	CCR	40	44.4	49.1	1	1	64.5	3.1
KSJD12A43L01	KSJD12C43L01	CT	CCT	43	47.8	52.8	1	1	69.4	2.9
KSJD12A45L01	KSJD12C45L01	CV	CCV	45	50	55.3	1	1	72.7	2.8
KSJD12A48L01	KSJD12C48L01	CX	CCX	48	53.3	58.9	1	1	77.4	2.6
KSJD12A51L01	KSJD12C51L01	CZ	CCZ	51	56.7	62.7	1	1	82.4	2.4
KSJD12A54L01	KSJD12C54L01	DE	CDE	54	60	66.3	1	1	87.1	2.3
KSJD12A58L01	KSJD12C58L01	DG	CDG	58	64.4	71.2	1	1	93.6	2.1
KSJD12A60L01	KSJD12C60L01	DK	CDK	60	66.7	73.7	1	1	96.8	1.8
KSJD12A64L01	KSJD12C64L01	DM	CDM	64	71.1	78.6	1	1	103	1.7
KSJD12A70L01	KSJD12C70L01	DP	CDP	70	77.8	86	1	1	113	1.5
KSJD12A75L01	KSJD12C75L01	DR	CDR	75	83.3	92.1	1	1	121	1.4
KSJD12A78L01	KSJD12C78L01	DT	CDT	78	86.7	95.8	1	1	126	1.4
KSJD12A85L01	KSJD12C85L01	DV	CDV	85	94.4	104	1	1	137	1.3
KSJD12A90L01	KSJD12C90L01	DX	CDX	90	100	111	1	1	146	1.2
KSJD12A100L01	KSJD12C100L01	DZ	CDZ	100	111	123	1	1	162	1.1
KSJD12A110L01	KSJD12C110L01	EE	CEE	110	122	135	1	1	177	1
KSJD12A120L01	KSJD12C120L01	EG	CEG	120	133	147	1	1	193	0.9
KSJD12A130L01	KSJD12C130L01	EK	CEK	130	144	159	1	1	209	0.8
KSJD12A150L01	KSJD12C150L01	EM	CEM	150	167	185	1	1	243	0.7
KSJD12A160L01	KSJD12C160L01	EP	CEP	160	178	197	1	1	259	0.7
KSJD12A170L01	KSJD12C170L01	ER	CER	170	189	209	1	1	275	0.6
KSJD12A180L01	KSJD12C180L01	ET	CET	180	201	222	1	1	292	0.5
KSJD12A200L01	KSJD12C200L01	EX	CEX	200	224	247	1	1	324	0.5
KSJD12A220L01	KSJD12C220L01	E22	GE22	220	246	272	1	1	356	0.5

Fig.1 Peak Pulse Power Rating Curve

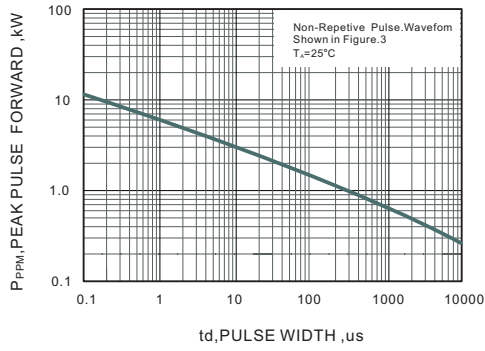

Fig.2 Forward Current Derating Curve

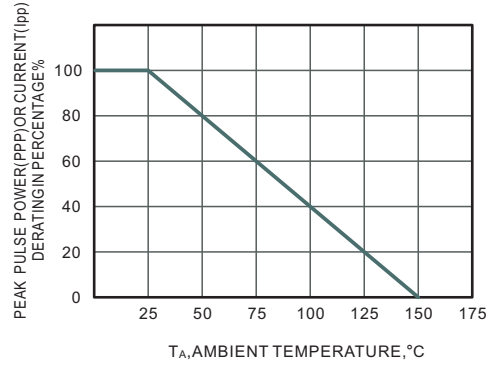

Fig.3 Pulse Waveform

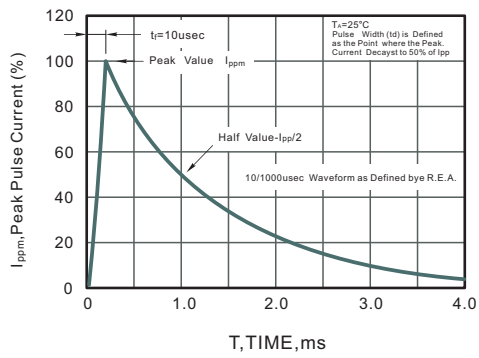
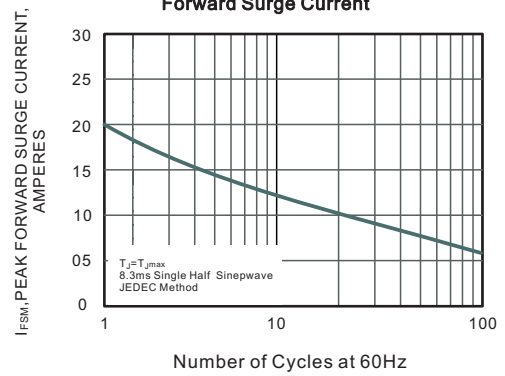

Fig.4 Maximum Non-Repetitive Peak Forward Surge Current



PACKAGE OUTLINE

Plastic surface mounted package; 2 leads

SOD-123FL

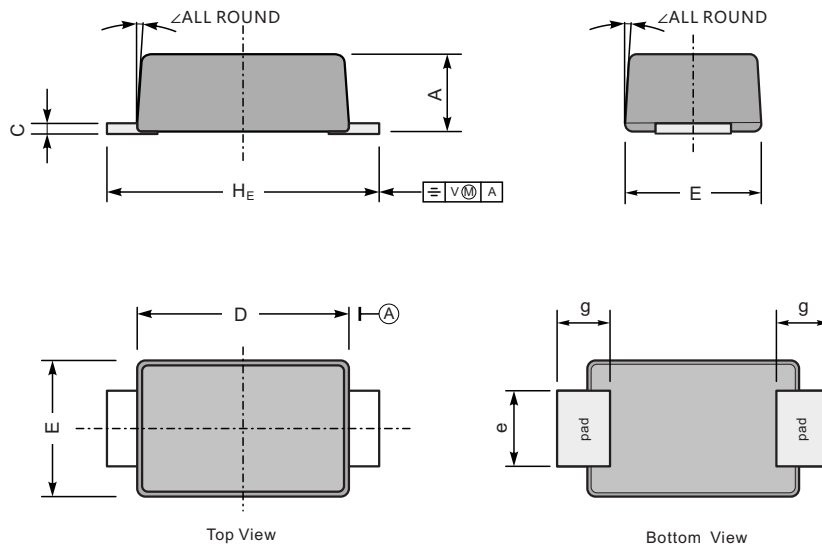

UNIT		A	C	D	E	e	g	H_E	\angle
mm	max	1.1	0.20	2.9	1.9	1.1	0.9	3.8	7°
	min	0.9	0.12	2.6	1.7	0.8	0.7	3.5	
mil	max	43	7.9	114	75	43	35	150	
	min	35	4.7	102	67	31	28	138	

The recommended mounting pad size

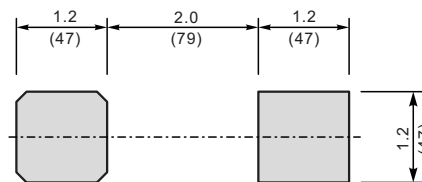

Unit: $\frac{\text{mm}}{\text{(mil)}}$

X-ON Electronics

Largest Supplier of Electrical and Electronic Components

Click to view similar products for [ESD Suppressors / TVS Diodes](#) category:

Click to view products by [Yongyutai Electronics](#) manufacturer:

Other Similar products are found below :

[60KS200C](#) [D18V0L1B2LP-7B](#) [D5V0F4U5P5-7](#) [NTE4902](#) [P4KE27CA](#) [P6KE11CA](#) [P6KE8.2A](#) [SA60CA](#) [SA64CA](#) [SMBJ12CATR](#)
[SMBJ33CATR](#) [SMBJ6.5A](#) [SMBJ8.0A](#) [ESD101-B1-02ELS](#) [E6327](#) [ESD112-B1-02EL](#) [E6327](#) [ESD7451N2T5G](#) [19180-510](#) [CPDT-5V0USP-](#)
[HF](#) [3.0SMCJ33CA-F](#) [3.0SMCJ36A-F](#) [HSPC16701B02TP](#) [JANTX1N6126A](#) [D3V3Q1B2DLP3-7](#) [D55V0M1B2WS-7](#) [SCM1293A-04SO](#)
[ESD200-B1-CSP0201](#) [E6327](#) [SM12-7](#) [CEN955](#) [W/DATA](#) [VESD12A1A-HD1-GS08](#) [CPDQC5V0-HF](#) [D1213A-01LP4-7B](#) [ESD101-B1-02EL](#)
[E6327](#) [AOZ8808DI-03](#) [5KP15A](#) [5KP48A](#) [5KP90A](#) [ESD3V3D7-TP](#) [15KPA36A-LF](#) [P4KE56CA](#) [P4KE68A](#) [P4KE91CATR](#) [P6KE120A](#)
[P6KE13CA](#) [P6KE43CA](#) [P6KE6.8CA](#) [P6KE8.2](#) [P6SMBJ20CA](#) [JANTX1N6072A](#) [SR2835ESKG](#) [SA90CA](#)