

### SOT-23 Plastic-Encapsulate MOSFETS N-Channel 20-V(D-S) MOSFET

| V(BR)DSS | RDS(on)MAX | ID |
|----------|------------|----|
| 20 V     | 25mΩ@4.5V  | 6A |
|          | 35mΩ@2.5V  |    |

**FEATURE**

※ TrenchFET Power MOSFET

**APPLICATION**

- ※ Load Switch for Portable Devices
- ※ DC/DC Converter

**MARKING**

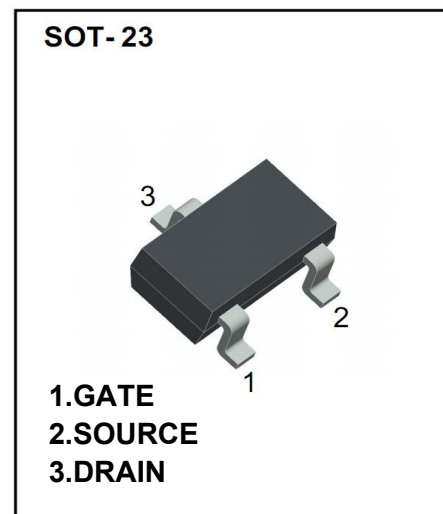
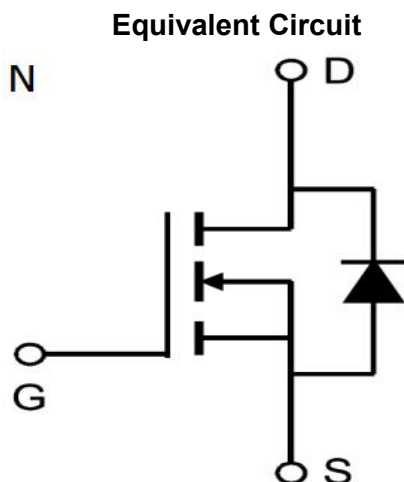
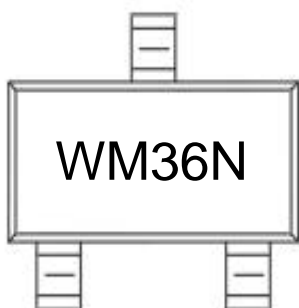

Maximum ratings ( Ta=25°C unless otherwise noted)

| Parameter  | Symbol | Value    | Unit |
|--|--------|----------|------|
| Drain-Source Voltage                               | VDS    | 20       | V    |
| Gate-Source Voltage                                | VGS    | ±12      |      |
| Continuous Drain Current                           | ID     | 6        | A    |
| Continuous Source-Drain Current(Diode Conduction)  | IS     | 0.6      |      |
| Power Dissipation                                  | PD     | 1.25     | W    |
| Thermal Resistance from Junction to Ambient (t≤5s) | RθJA   | 150      | °C/W |
| Operating Junction                                 | TJ     | 150      | °C   |
| Storage Temperature                                | TSTG   | -55~+150 | °C   |

## Static Electrical Characteristics (Ta = 25 °C Unless Otherwise Noted)

| Parameter                                 | Symbol   | Test Condition                                   | Min  | Typ  | Max  | Unit |
|---|----------|--|------|------|------|------|
| <b>Static</b>                             |          |  |      |      |      |      |
| Drain-source breakdown voltage            | V(BR)DSS | VGS = 0V, ID =250μA                              | 20   |      |      | V    |
| Gate-threshold voltage                    | VGS(th)  | VDS =VGS, ID =250μA                              | 0.45 |      | 1    | V    |
| Gate-body leakage                         | IGSS     | VDS =0V, VGS =±12V                               |      |      | ±100 | nA   |
| Zero gate voltage drain current           | IDSS     | VDS =16V, VGS =0V                                |      |      | 1    | μA   |
| Drain-source on-resistance <sup>a</sup>   | RDS(on)  | VGS =4.5V, ID = 6A                               |      | 22   | 25   | mΩ   |
|   |          | VGS =2.5V, ID =4A                                |      | 28   | 35   | mΩ   |
| Forward transconductance <sup>a</sup>     | gfs      | VDS =5V, ID =6A                                  |      | 8    |      | S    |
| Diode forward voltage                     | VSD      | IS=1A, VGS=0V                                    |      | 0.74 | 1.28 | V    |
| <b>Dynamic</b>                            |          |  |      |      |      |      |
| Total gate charge                         | Qg       | VDS =10V, VGS =4.5V,<br>ID =6A                   |      | 7.7  | 10   | nC   |
| Gate-source charge                        | Qgs      |  |      | 0.32 |      | nC   |
| Gate-drain charge                         | Qgd      |  |      | 2.1  |      | nC   |
| Input capacitance <sup>b</sup>            | Ciss     | VDS =10V, VGS =0V,<br>f=1MHz                     |      | 574  |      | pF   |
| Output capacitance <sup>b</sup>           | Coss     |  |      | 70   |      | pF   |
| Reverse transfer capacitance <sup>b</sup> | Crss     |  |      | 60   |      | pF   |
| <b>Switching<sup>b</sup></b>              |          |  |      |      |      |      |
| Turn-on delay time                        | td(on)   | VDD=10V<br>RL=5.5Ω, ID ≈3.6A,<br>VGEN=4.5V,Rg=6Ω |      | 78.7 |      | ns   |
| Rise time                                 | tr       |  |      | 128  |      | ns   |
| Turn-off delay time                       | td(off)  |  |      | 453  |      | ns   |
| Fall time                                 | tf       |  |      | 80.9 |      | ns   |

### Note :

1. Repetitive Rating : Pulse width limited by maximum junction temperature.
2. Surface Mounted on FR4 Board, t < 5 sec.
3. Pulse Test : Pulse Width≤300μs, Duty Cycle ≤ 2%.
4. Guaranteed by design, not subject to production testing.

**TYPICAL ELECTRICAL AND THERMAL CHARACTERISTICS**

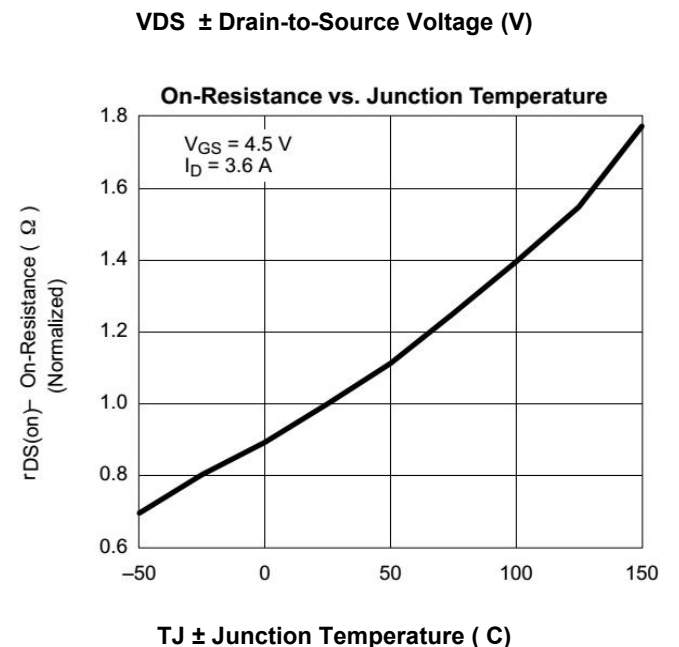
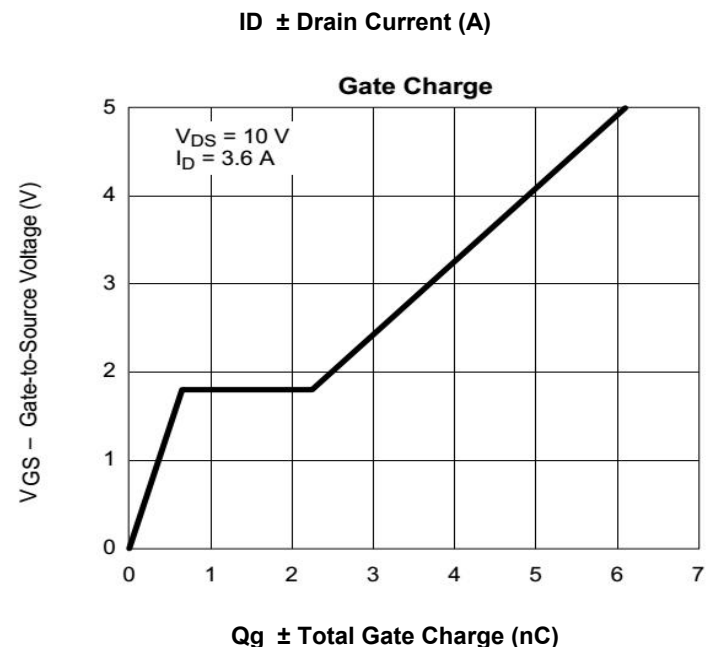
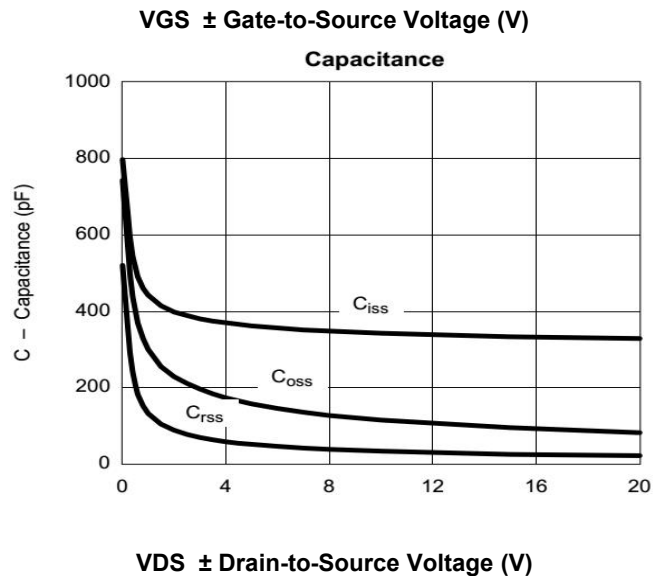
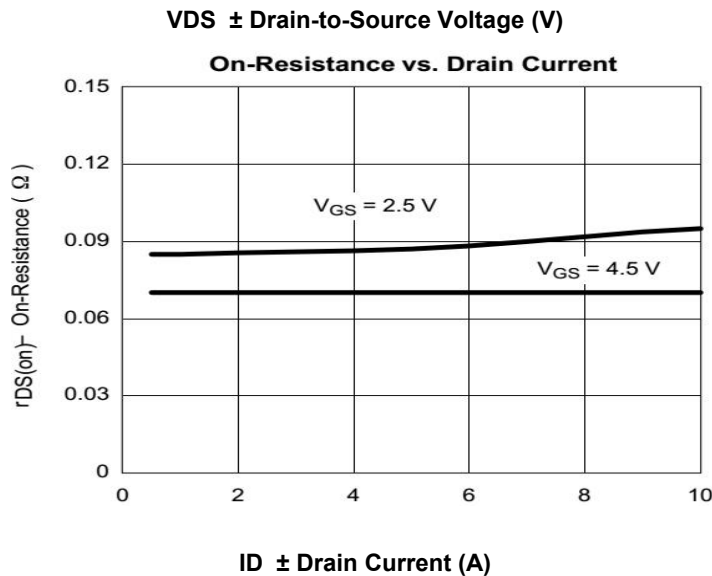
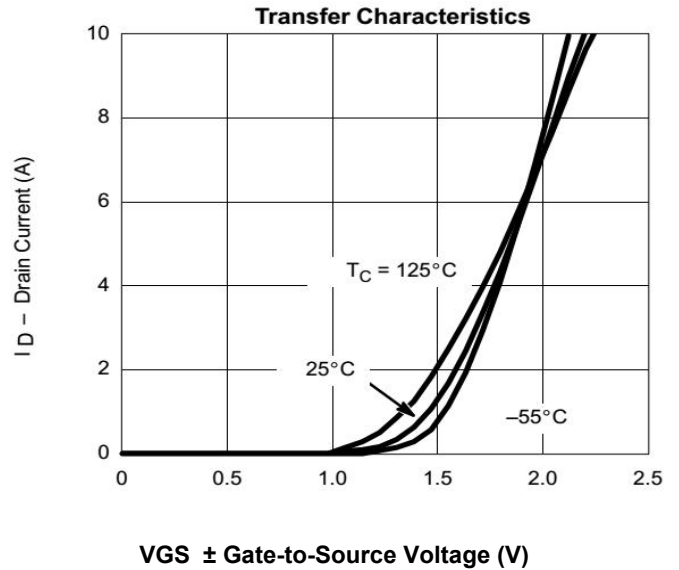
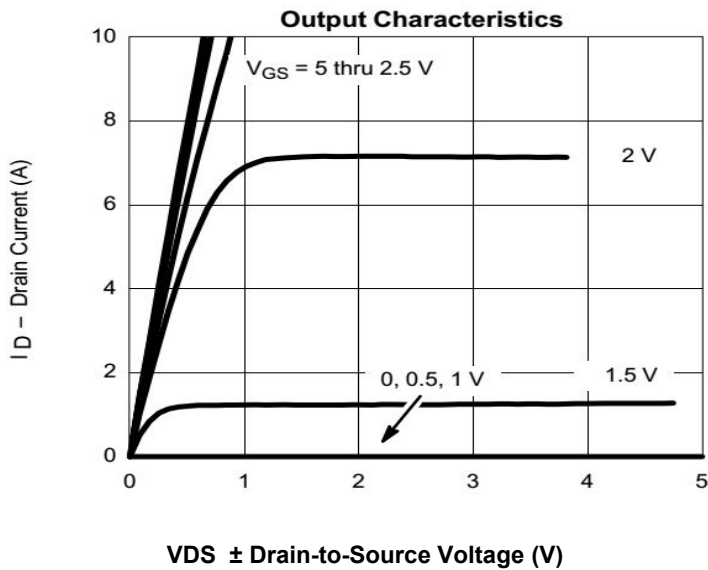

**TYPICAL ELECTRICAL AND THERMAL CHARACTERISTICS**

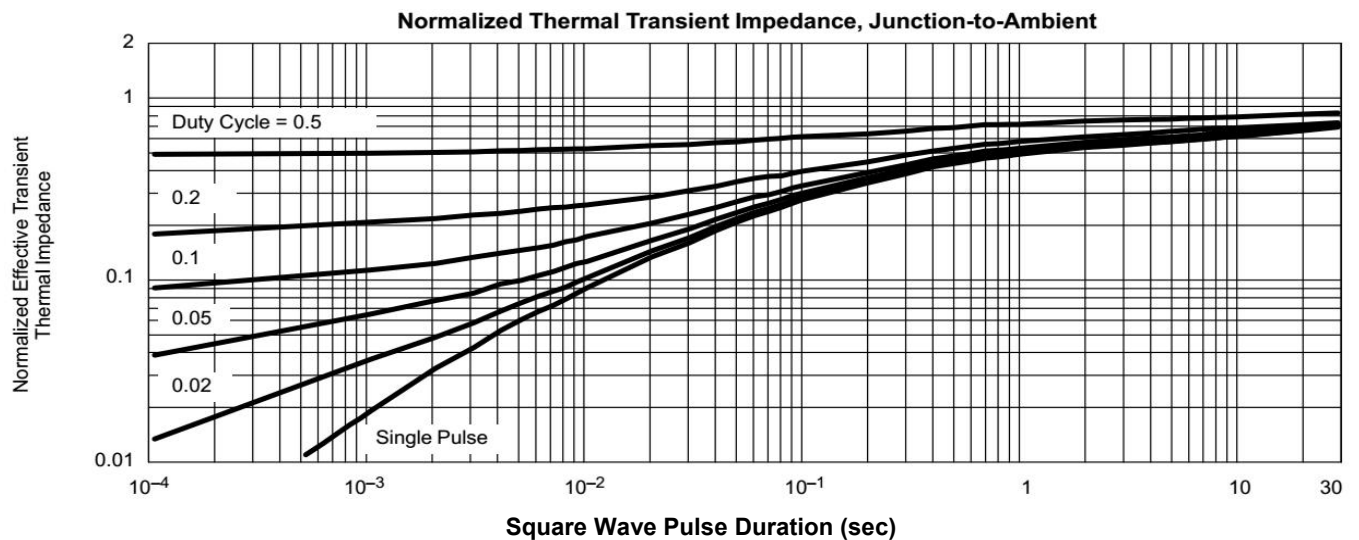
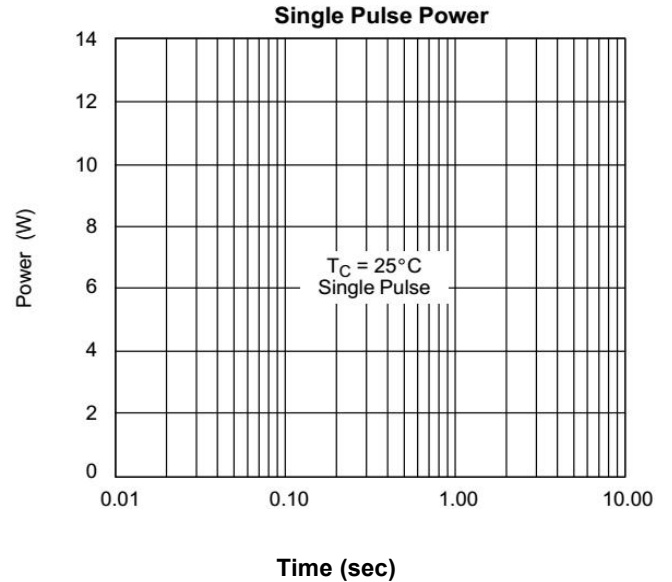
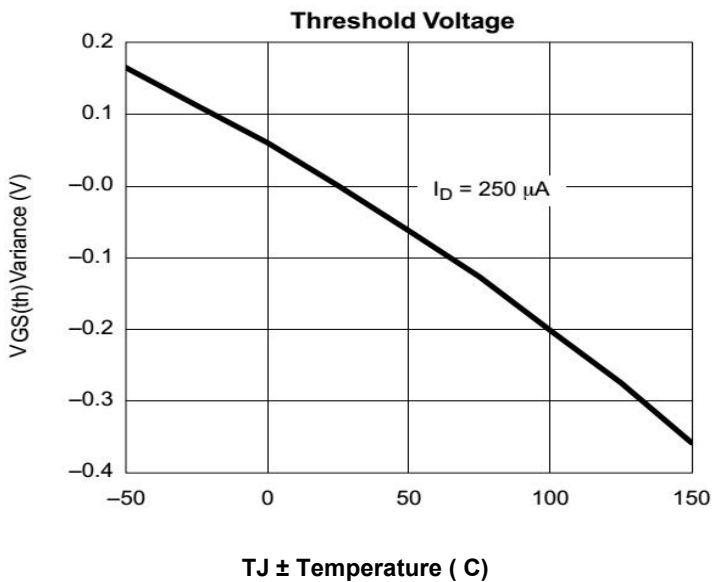
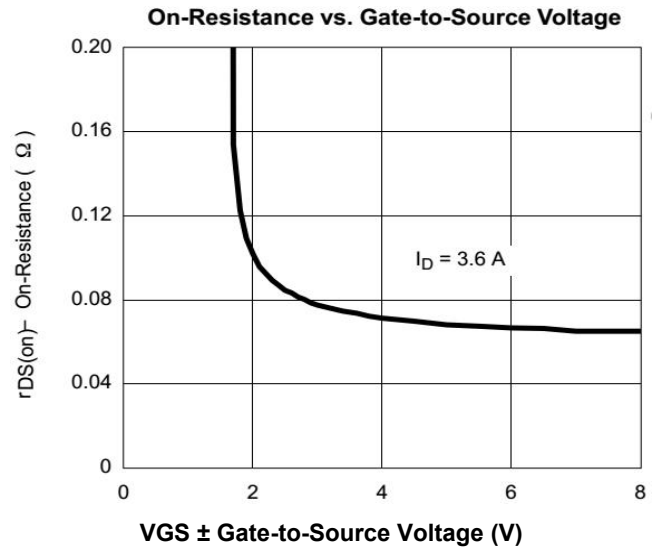
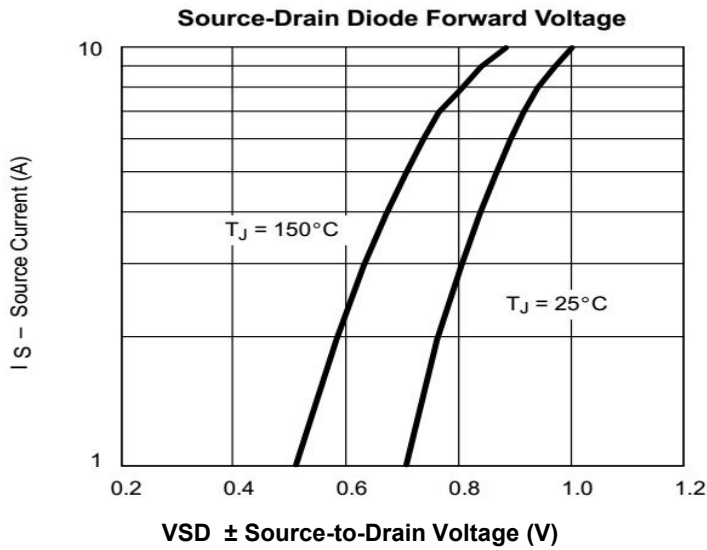

**SOT-23 PACKAGE OUTLINE DIMENSIONS**

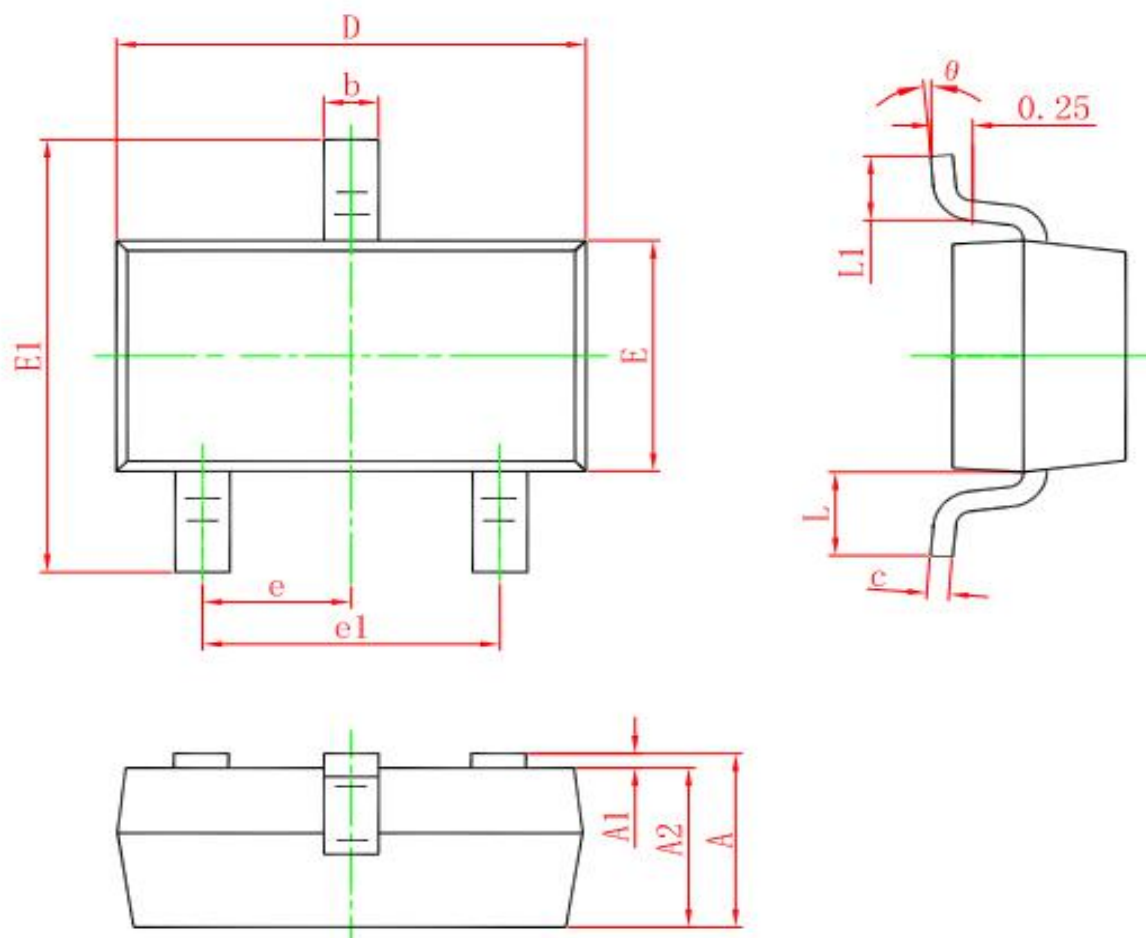

| Symbol | Dimensions In Millimeters |       | Dimensions In Inches |       |
|--------|---------------------------|-------|----------------------|-------|
|        | Min.                      | Max.  | Min.                 | Max.  |
| A      | 0.900                     | 1.150 | 0.035                | 0.045 |
| A1     | 0.000                     | 0.100 | 0.000                | 0.004 |
| A2     | 0.900                     | 1.050 | 0.035                | 0.041 |
| b      | 0.300                     | 0.500 | 0.012                | 0.020 |
| c      | 0.080                     | 0.150 | 0.003                | 0.006 |
| D      | 2.800                     | 3.000 | 0.110                | 0.118 |
| E      | 1.200                     | 1.400 | 0.047                | 0.055 |
| E1     | 2.250                     | 2.550 | 0.089                | 0.100 |
| e      | 0.950 TYP.                |       | 0.037 TYP.           |       |
| e1     | 1.800                     | 2.000 | 0.071                | 0.079 |
| L      | 0.550 REF.                |       | 0.022 REF.           |       |
| L1     | 0.300                     | 0.500 | 0.012                | 0.020 |
| θ      | 0°                        | 8°    | 0°                   | 8°    |

## X-ON Electronics

Largest Supplier of Electrical and Electronic Components

*Click to view similar products for [MOSFET](#) category:*

*Click to view products by [Yongyutai Electronics](#) manufacturer:*

Other Similar products are found below :

[IRFD120](#) [JANTX2N5237](#) [2SK2267\(Q\)](#) [BUK455-60A/B](#) [TK100A10N1,S4X\(S](#) [MIC4420CM-TR](#) [VN1206L](#) [NDP4060](#) [SI4482DY](#)  
[IRS2092STRPBF-EL](#) [IPS70R2K0CEAKMA1](#) [TK31J60W5,S1VQ\(O](#) [TK31J60W,S1VQ\(O](#) [TK16J60W,S1VQ\(O](#) [2SK2614\(TE16L1,Q\)](#)  
[DMN1017UCP3-7](#) [EFC2J004NUZTDG](#) [P85W28HP2F-7071](#) [DMN1053UCP4-7](#) [NTE2384](#) [DMC2700UDMQ-7](#) [DMN2080UCB4-7](#)  
[DMN61D9UWQ-13](#) [US6M2GTR](#) [DMN31D5UDJ-7](#) [DMP22D4UFO-7B](#) [IPS60R3K4CEAKMA1](#) [DMN1006UCA6-7](#) [DMN16M9UCA6-7](#)  
[STF5N65M6](#) [IRF40H233XTMA1](#) [STU5N65M6](#) [DMN6022SSD-13](#) [DMN13M9UCA6-7](#) [DMTH10H4M6SPS-13](#) [IPS60R360PFD7SAKMA1](#)  
[DMN2990UFB-7B](#) [SSM3K35CT,L3F](#) [IPLK60R1K0PFD7ATMA1](#) [2N7002W-G](#) [MCAC30N06Y-TP](#) [IPWS65R035CFD7AXKSA1](#)  
[MCQ7328-TP](#) [SSM3J143TU,LXHF](#) [DMN12M3UCA6-7](#) [PJMF280N65E1\\_T0\\_00201](#) [PJMF380N65E1\\_T0\\_00201](#)  
[PJMF280N60E1\\_T0\\_00201](#) [PJMF600N65E1\\_T0\\_00201](#) [PJMF900N65E1\\_T0\\_00201](#)